

Inductive distance measuring sensors

IR18.D03K-11158155

dimension drawing

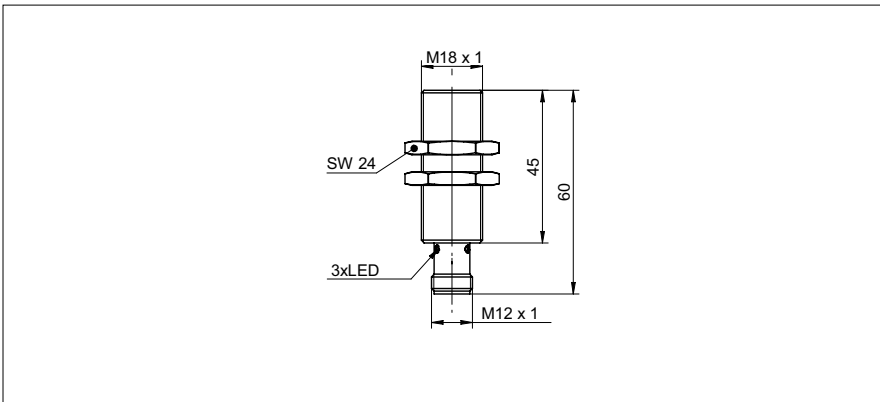

general data

mounting type	flush
special type	linearized high sensitivity
measuring distance Sd	2,75 ... 3 mm
sensitivity	40 V/mm (Range: 0,25 mm)
resolution	< 0,001 mm (stat.) < 0,001 mm (dynam.)
repeat accuracy	< 0,005 mm
adjustment	external Teach-in
teach	1-point analog, factory reset
linearity error	± 5 µm
temperature drift	± 4 % (Full Scale; +10 ... +30 °C) ± 12 % (Full Scale; -10 ... +60 °C)

electrical data

response time (factory characteristic)	< 3 ms
voltage supply range +Vs	12 ... 30 VDC
current consumption max. (no load)	15 mA
output circuit	voltage output
output signal	0 ... 10 VDC
load resistance	> 4000 Ohm
short circuit protection	yes
reverse polarity protection	yes

mechanical data

type	cylindrical threaded
material (sensing face)	ceramic
housing material	steel nickel plated
dimension	18 mm
housing length	60 mm
connection types	connector M12
tightening torque max.	40 Nm

ambient conditions

operating temperature	-10 ... +60 °C
protection class	IP 67

photo



connection diagram

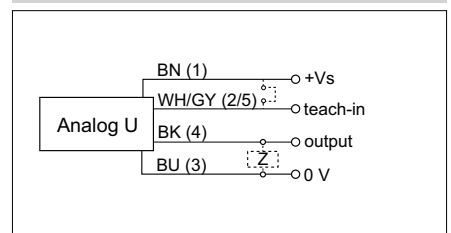

- measuring range (0,25 mm) adjustable within 1 - 3 mm
- linear analog output
- high sensitivity (other sensitivities on request)