

Inductive distance measuring sensors

IR18.D08L-11141092

dimension drawing

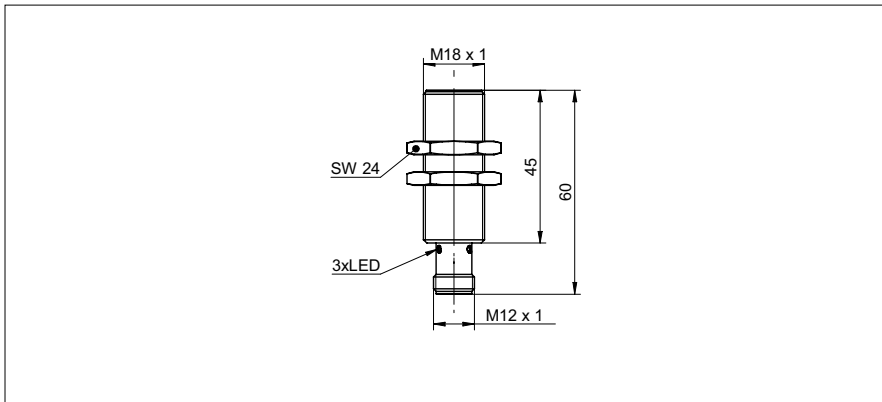

general data

mounting type	quasi-flush
special type	linearized
measuring distance Sd	0 ... 8 mm
sensitivity	1,25 V/mm
resolution	< 0,008 mm (stat.) < 0,01 mm (dynam.)
repeat accuracy	< 0,015 mm
adjustment	external Teach-in
teach	1-point analog, 2-point analog, factory reset
linearity error	± 32 µm
temperature drift	± 3 % (Full Scale)

electrical data

response time (factory characteristic)	< 1 ms
voltage supply range +Vs	12 ... 36 VDC
current consumption max. (no load)	15 mA
output circuit	voltage output
output signal	0 ... 10 VDC
load resistance	> 4000 Ohm
short circuit protection	yes
reverse polarity protection	yes

mechanical data

type	cylindrical threaded
housing material	brass nickel plated
dimension	18 mm
housing length	60 mm
connection types	connector M12
tightening torque max.	40 Nm

ambient conditions

operating temperature	-25 ... +75 °C
protection class	IP 67

photo



connection diagram

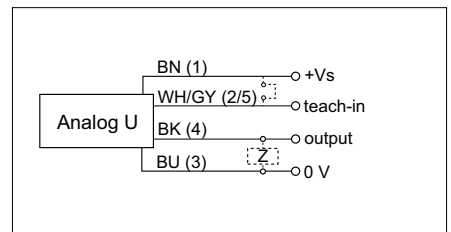

- external Teach-in
- linear analog output