

## M8K/M12S Adapter Connector

- Coupling M8, 3-poled / Connector M12, 3-poled
- Turnable metal screw
- High protection class by IP 67

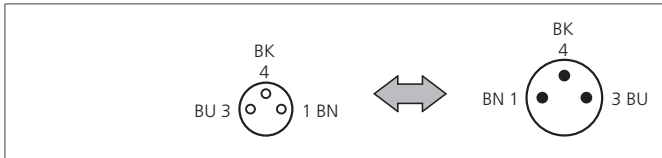

### Safety instructions

The Instruments are not to be used for safety applications, in particular applications in which safety of persons depends on proper operation of the instruments.  
These instruments shall exclusively be used by qualified personnel.

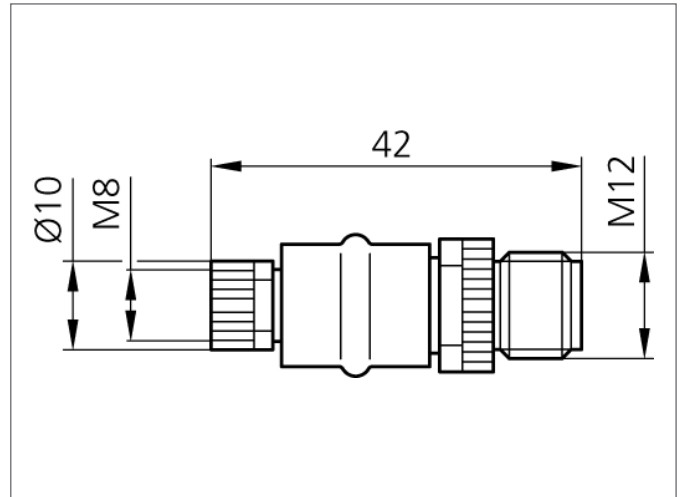

### TECHNICAL INFORMATION (typ.)

Design	straight
Service voltage	< 24 V with max. 4,0 A
Protection class	IP 67
Casing material	plastics
Connection sensor side	Socket, M8x1, 3-poled
Connection control side	Connector, M12x1, 3-poled