

SH-GLA-14-14-40

Gelenkarm

Articulated arm

Bras articulé

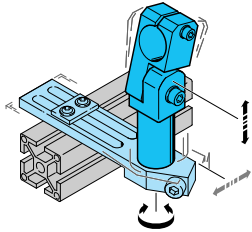

di-soric GmbH & Co. KG
 Steinbeisstraße 6
 DE-73660 Urbach
 Fon: +49 (0) 71 81 / 98 79 - 0
 Fax: +49 (0) 71 81 / 98 79 - 179
 info@di-soric.com
 www.di-soric.com

203904

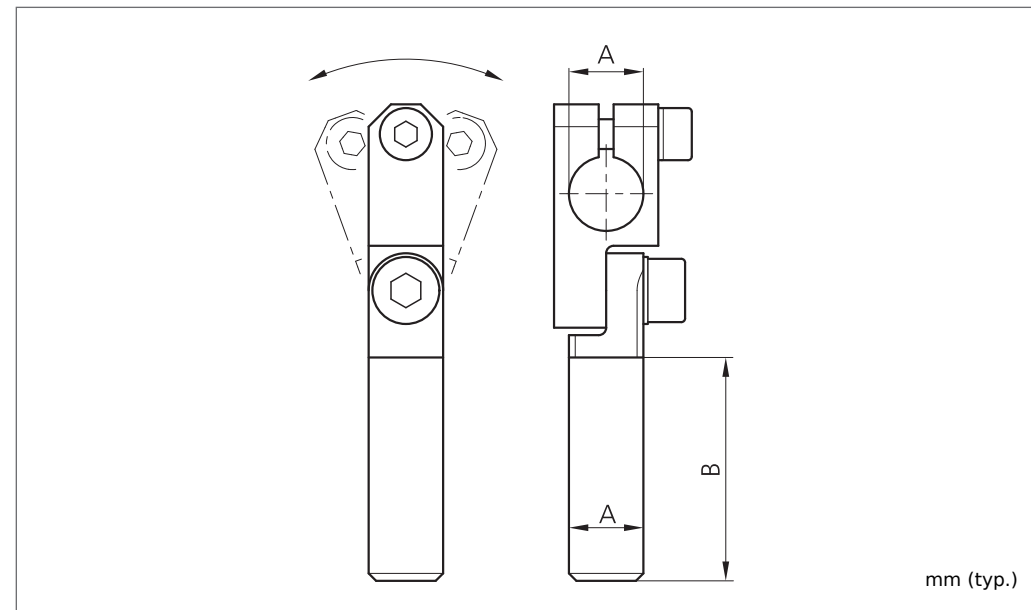

mm (typ.)

Technische Daten (typ.)	Technical data (typ.)	Caractéristique techniques	
Größe	Size	Dimensions	14 mm/14 mm/14 mm (A), 40 mm
Besonderheiten	Characteristics	Caractéristiques	Justierbar/Adjustable
Für	For	Pour	Klemmbolzen 14 mm/Clamping pin 14 mm/Clamping pin 14 mm
Gehäusematerial	Casing material	Matériau du boîtier	Metall/metal/Métal
Produktserie	Product series		Systemhalter SH/System holder SH