

BEE-F50/50V-G0TI-IBS

Backlight

- Robust stainless steel casing for use in the pharma, beverage and food industry
- Constant level of light intensity over the entire voltage range
- Homogenous luminous field
- High efficiency
- External trigger input
- Light intensity can be adjusted

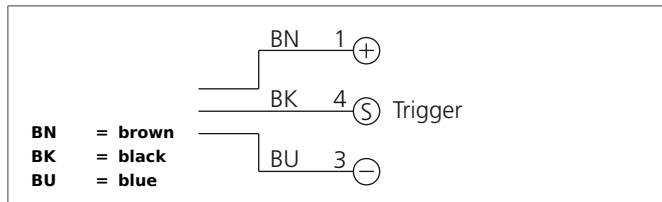

Safety instructions

The Instruments are not to be used for safety applications, in particular applications in which safety of persons depends on proper operation of the instruments.

These instruments shall exclusively be used by qualified personnel.

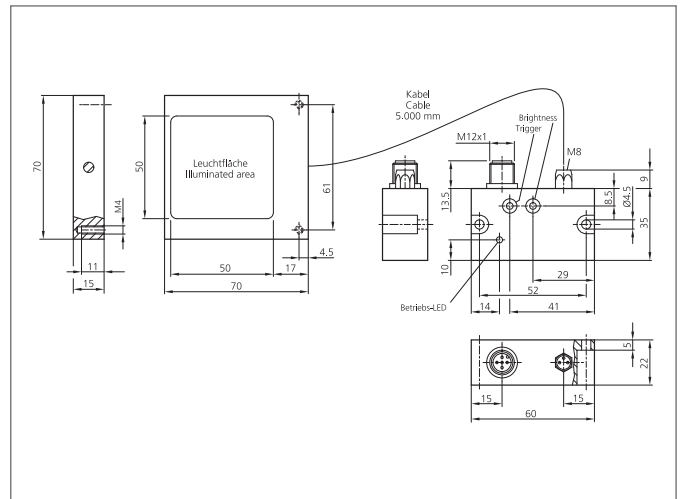

TECHNICAL INFORMATION (typ.)	+20°C, 24V DC
Design	Backlight
Illuminated area	50 x 50 mm
Characteristics	External control of power output
Light colour	Infrared, 850 nm
Service voltage	10 ... 35 V DC (Supply Class 2)
Internal power consumption	max. 240 mA, (10 V DC)
Trigger input low level	0 ... <2,8 V
Trigger input high level	> 3,3 ... 35 V
Power	5,0 W (10...35 V DC)
Shock-/vibration load	10 ... 55 Hz / 1,0 mm / 30 g
Display	LED: green - operation indicator
Ambient temperature	0 ... +50 °C
Protection class	IP 69K, IP 67, (electronic control)
Protection degree	III, operation on protective low voltage
Risk group (DIN EN 62471)	Free group
Casing material	stainless steel V4A, (1.4404 / AISI 316L - 1.4571 / AISI 316Ti)
Connection	5 m, Cable, M8, 4-poled, (Lighting), M12, (electronic control)
Connecting cable	VK ...