

**HS-S-12-200-V**  
**Montagegestange**  
**Mounting rod**  
**Barre de montage**

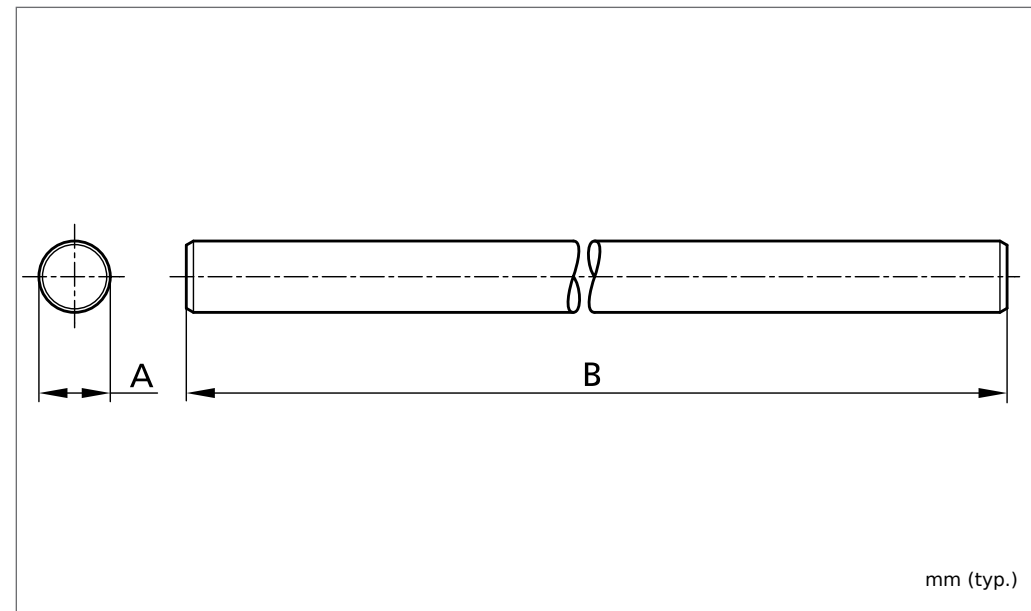

di-soric GmbH & Co. KG  
 Steinbeisstraße 6  
 DE-73660 Urbach  
 Fon: +49 (0) 71 81 / 98 79 - 0  
 Fax: +49 (0) 71 81 / 98 79 - 179  
 info@di-soric.com  
 www.di-soric.com

209473



Technische Daten (typ.)	Technical data (typ.)	Caractéristique techniques	
Maß	Dimension	Dimensions	Ø 12 mm, 200 mm
Gehäusematerial	Casing material	Matériau du boîtier	Edelstahl/stainless steel/acier inoxydable
Produktserie	Product series		Systemhalter HS/System holder HS



# Systemhalter Serie HS

Grundhalter Ø 12 mm

# System holder series HS

Basic system holder Ø 12 mm

# Systèmes de fixation Série HS

12 mm du support Ø de système de base

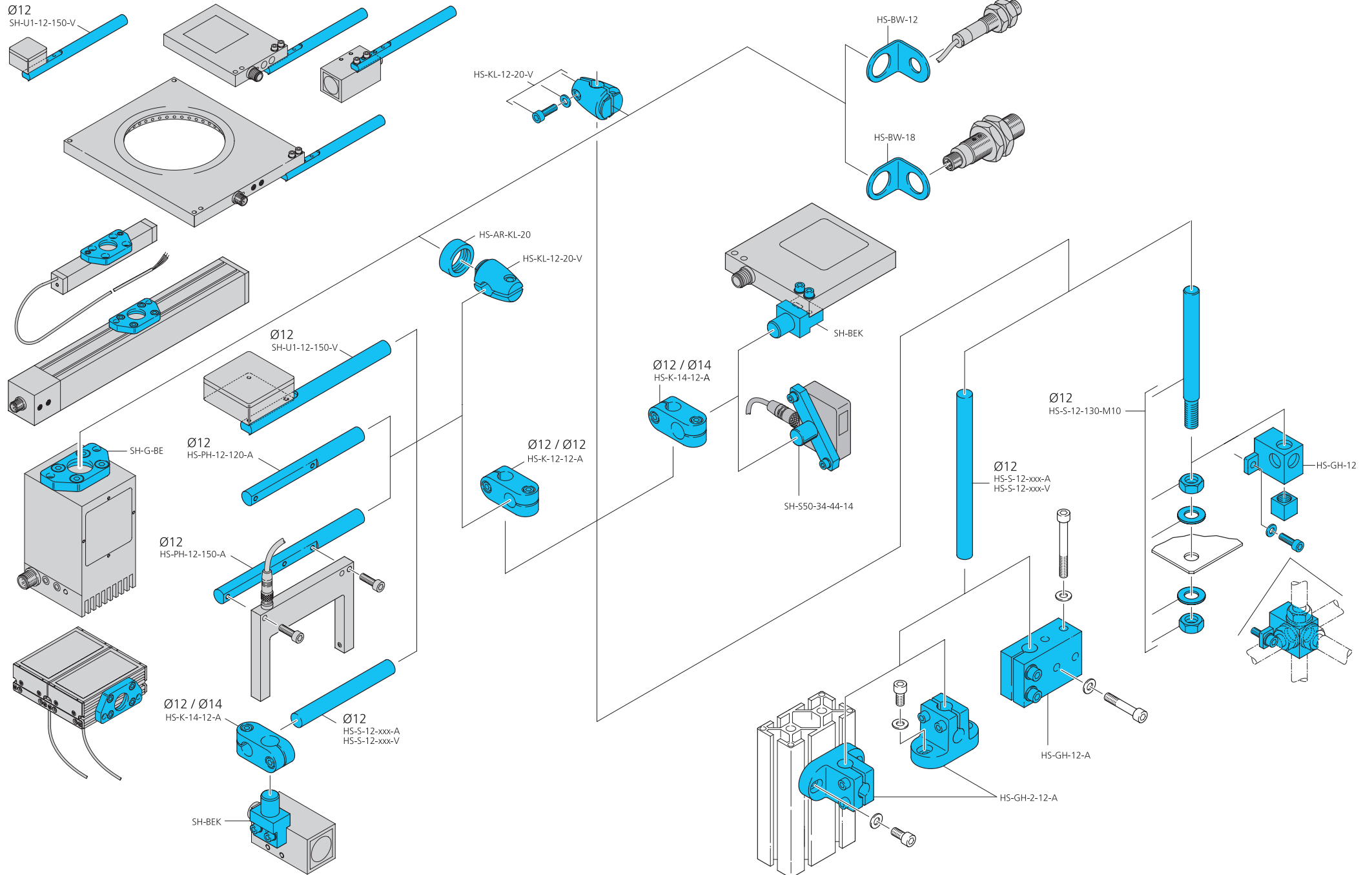

# Systemhalter Serie HS

Grundhalter Ø 15 mm

# System holder series HS

Basic system holder Ø 15 mm

# Systèmes de fixation Série HS

15 mm du support Ø de système de base

