

HS-BW-12 Mounting bracket

- Highly flexible versatile mounting system
- All-purpose mounting
- Smooth adjustment
- Robust design

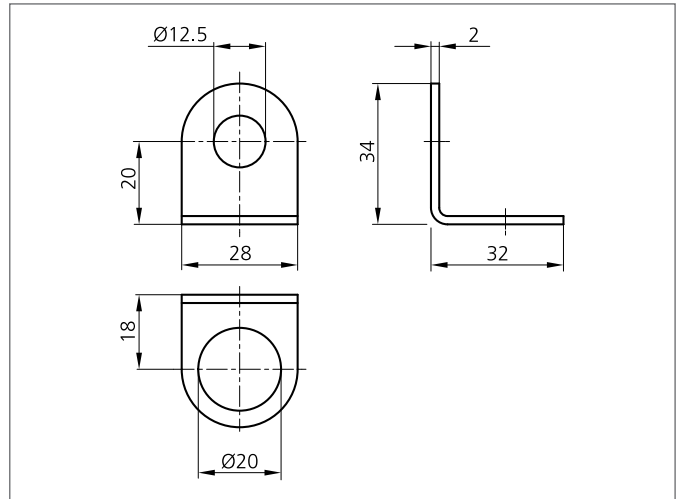
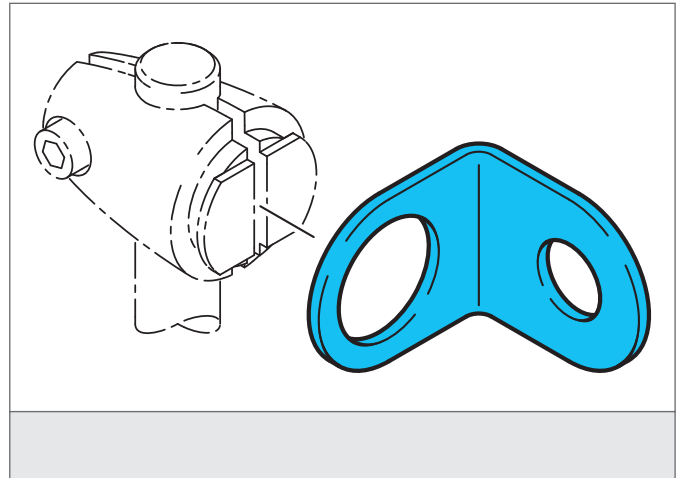

TECHNICAL INFORMATION (typ.)

Dimension	Ø 12,5 / Ø 20 mm (Diameter assembly tap/drilling)
Casing material	stainless steel
Product series	System holder HS