

BEK-A400-G5T-K-BS

Barlight

- Extremely high light intensity thanks to most modern high power LEDs
- Integrated single-line power control with high efficiency
- Intelligent temperature control with switch-off automatic
- Homogeneous light field thanks to special LED-optics
- High protection class
- Separate entries for trigger signal and trigger polarity
- Robust metal casing
- Universal mounting possibility
- Scratch-proof protection window
- Crossbars and focus optics available as an option

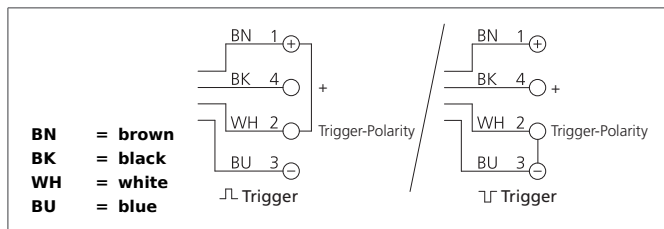

Safety instructions

The Instruments are not to be used for safety applications, in particular applications in which safety of persons depends on proper operation of the instruments.
These instruments shall exclusively be used by qualified personnel.

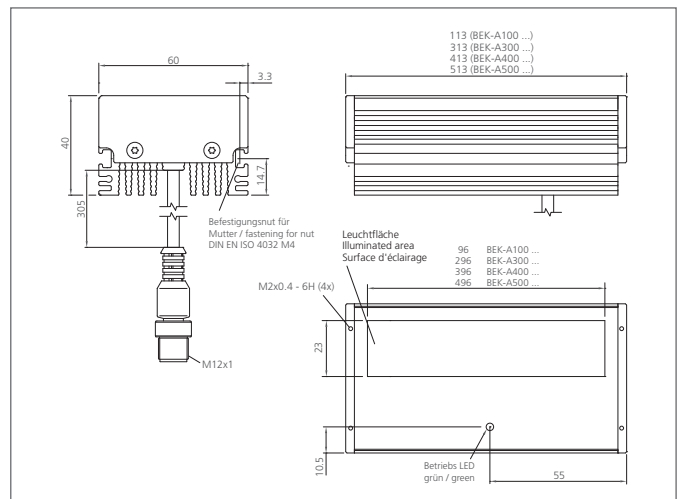

TECHNICAL INFORMATION (typ.)	+20°C, 24V DC
Design	Barlight
Illuminated area	23 x 396 mm
Characteristics	Internal control of power output
Light colour	White, 6000 K
Emission angle	30°
Illumination intensity	125 kLux (0,1 m), 68 kLux (0,2 m), 27 kLux (0,5 m)
Service voltage	18 ... 30 V DC (Supply Class 2)
Internal power consumption	1.400 mA, (24 V DC)
Trigger input low level	0 ... <2,8 V
Trigger input high level	> 3,3 ... 30 V
Power	33,0 W (24 V DC)
Shock-/vibration load	10 ... 55 Hz / 1,0 mm / 30 g
Inverse polarity protection	Yes
Ambient temperature	0 ... +40 °C
Protection class	IP 67
Protection degree	III, operation on protective low voltage
Risk group (DIN EN 62471)	Risk group 1
Operating mode	LED: green
Casing material	Aluminium black anodized
Material	PMMA, hardcoated (protective glass)
Connection	Cable, 300 mm, + connector M12, 4-poled
Weight	1.350 g
Connecting cable	VK ...