

ID-80-IM3-2-U
ID-Handlesegerät
ID-Handheld
Lecteur portatif

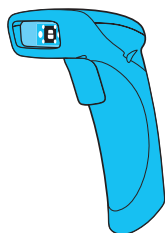

di-soric Solutions GmbH & Co. KG
 Steinbeisstraße 6
 73660 Urbach Germany
 Fon: +49 (0) 71 81 / 98 78 - 0
 Fax: +49 (0) 71 81 / 98 78 - 177
 solutions@di-soric.com
 www.di-soric-solutions.com

210542

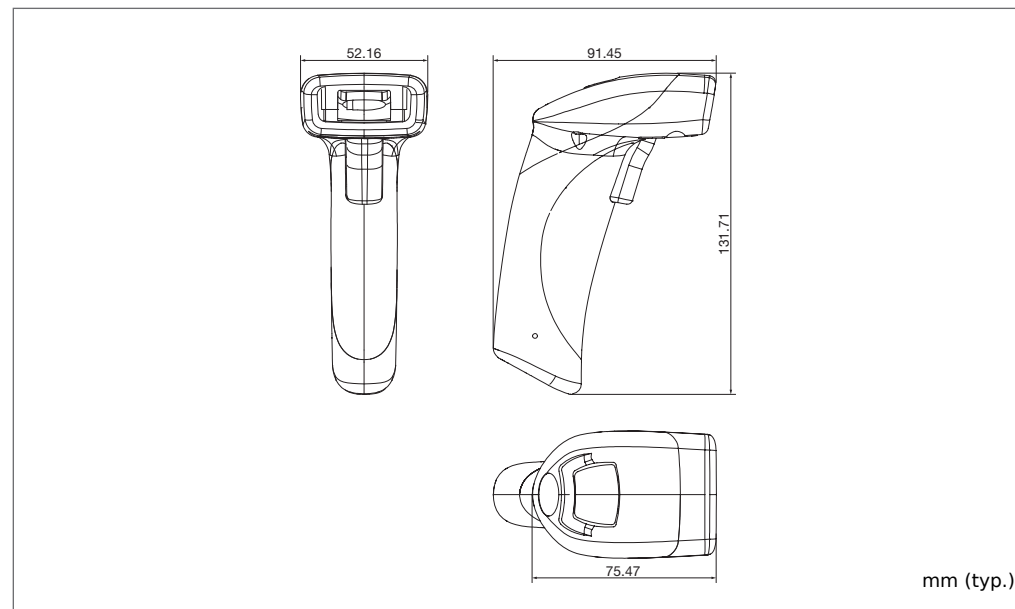
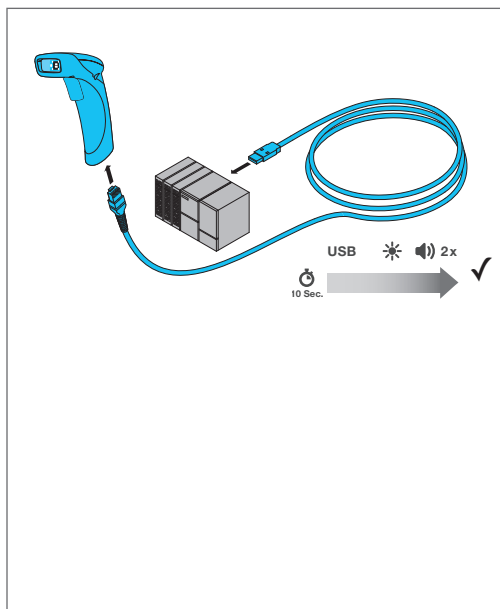

Technische Daten (typ.)	Technical data (typ.)	Caractéristique techniques	+20°C, 5V DC
Größe	Size	Dimensions	132 x 52 x 91 mm
Betriebsspannung	Service voltage	Tension d'alimentation	5 V DC
Eigenstromaufnahme	Internal power consumption	Courant absorbé	< 300 mA
Schnittstelle	Interface	Interface	USB-A (Betrieb mit ID-K-RJ50/U-2)/USB-A (operated with ID-K-RJ50/U-2)/USB-A (exploité avec ID-K-RJ50/U-2)
Anschluss	Connection	Connexion	USB-Kabel 1,8 m/USB-Cable 1.8 m
Position Scanner zu Code	Position scanner to code		Tilt 180°, Pitch ± 65°, Skew ± 60°
Bildsensor	Image sensor	Capteur d'image	CMOS



Sicherheitshinweis
 Diese Geräte sind nicht zulässig für Sicherheitsanwendungen, insbesondere bei denen die Sicherheit von Personen von der Gerätefunktion abhängig ist. Der Einsatz der Geräte muss durch Fachpersonal erfolgen.

Safety instructions
 The Instruments are not to be used for safety applications, in particular applications in which safety of persons depends on proper operation of the instruments. These instruments shall exclusively be used by qualified personnel.

Instructions de sûreté
 La mise en œuvre de ces appareils doit être effectuée par du personnel qualifié. Ils ne doivent pas être utilisées pour des applications dans lesquelles la sécurité des personnes dépend du bon fonctionnement du matériel.

ID-Handlesegeräte / ID-Handheld								Produktbezeichnung Product-ID
	■	■	■	180	±65	±60	■	ID-80-IM3-2-U
							■	ID-80-IM3-2-S

Handhabung / Handling

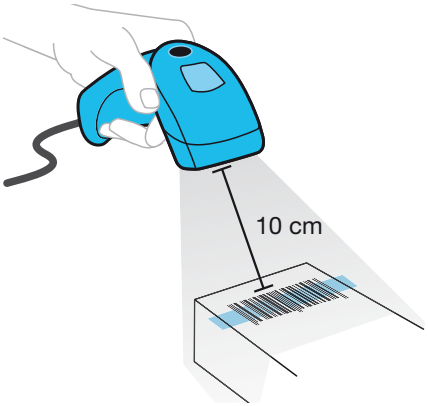

10 cm

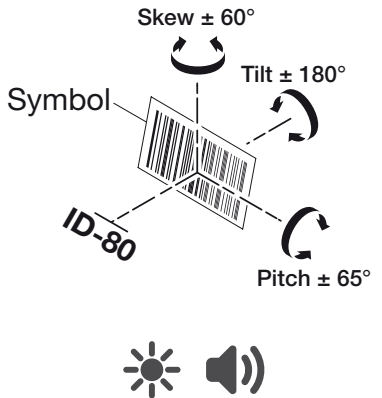

Skew $\pm 60^\circ$
Tilt $\pm 180^\circ$
Pitch $\pm 65^\circ$

Symbol
ID-80

Anschluss / Connection

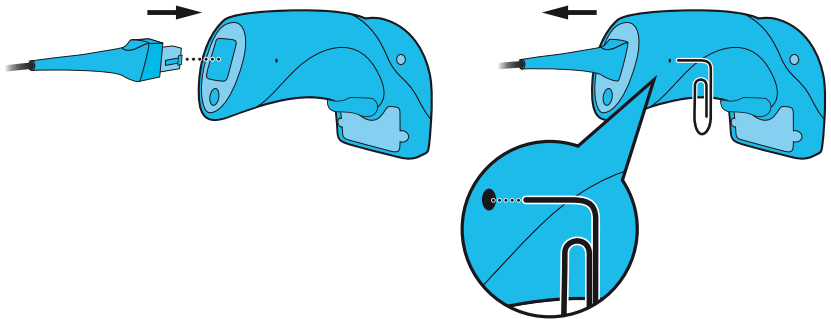

Artikelliste / Article list

ID-80 - mit USB-Schnittstelle / with USB Interface	Product-ID
	ID-80-IM3-2-U

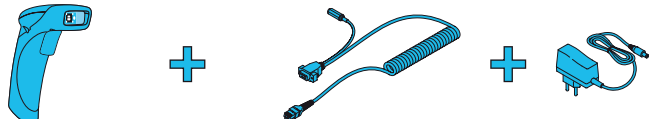
ID-80 - mit RS232-Schnittstelle / with RS232 Interface	Product-ID
	ID-80-IM3-2-S

Das gesamte im Lieferumfang enthaltene Zubehör ist auch optional erhältlich:
The complete accessories included in the scope of delivery are also separately available:

USB-Verbindungskabel, nur für ... / USB Connecting Cable, only for ... ID-80-IM3-2-U	Product-ID
 Länge / Length: 1.800mm Anschluss / Connection: RJ50 auf / to USB-A	ID-K-RJ50/U-2

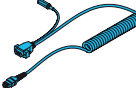
RS232-Verbindungskabel, nur für ... / RS232 Connecting Cable, only for ... ID-80-IM3-2-S	Product-ID
 Spiralkabel / coiled cable Länge / Length: 2.400mm Anschluss / Connection: RJ50 auf / to Sub-D/DC Jack → Zur Verwendung mit / For use with ID-PS-230/5V-DCJ	ID-K-SD/DCJ-RJ50-2

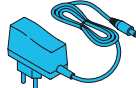
Netzteil / Power Supply	Product-ID
 Anschlussspannung / Supply voltage: 230 VAC Ausgangsspannung / Output voltage: 5VDC Anschluss / Connection: DC Jack → Zur Verwendung mit / For use with ID-K-SD/DCJ-RJ50-2	ID-PS-230/5V-DCJ

Inbetriebnahme / Set Up

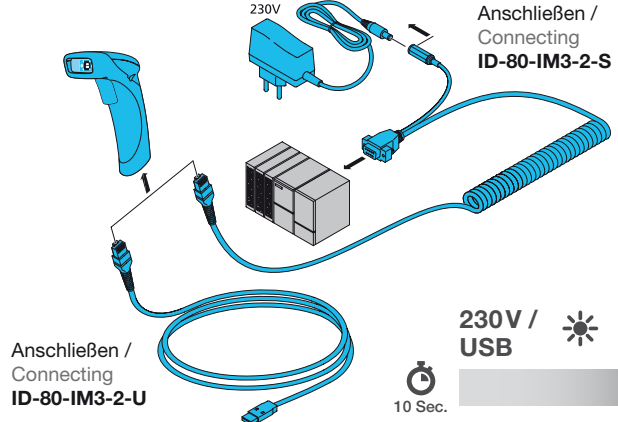

Anschließen / Connecting
ID-80-IM3-2-S

Anschließen / Connecting
ID-80-IM3-2-U

230V / USB

10 Sec.

2x

