

# PCB Relays Safety Relays



**DOLD** 

# Dold Agents for PCB relays

## Europe

### Austria

IPR Industrieprodukte  
Konrad Rechberger  
Rosenleiten 84  
A-4101 Feldkirchen  
Phone: +43 7233 662111  
Fax: +43 7233 662121  
e-mail: office@ipr.or.at

### Belgium

Tempolec S.A.  
Route de Biesme 49  
B-6530 Thuin  
Phone: +32 71 590039  
Fax: +32 71 590161  
e-mail: purchasing@tempolec.be

### Czech Republic

OS-KOM spol.s.r.o  
Zdikovská 22  
CZ 150 00 Praha 5 - Smichov  
Phone: +420 2 57210114  
Fax: +420 2 57211935  
e-mail: oskom@oskom.cz

### Denmark

ICS A/S  
Holkebjergvej 79  
DK-5260 Odense SV  
Phone +45 66 17 10 74  
Fax +45 66 17 10 65  
E-mail ics@ics-as.dk  
internet http://www.ics-as.dk

### England

Dold Industries Ltd.  
11 Lamberts Rd. Blackall Ind.Estate,  
South Woodham Ferrers  
Essex, CM 3 5UW  
Phone: +44 1245 324432  
Fax: +44 1245 325570  
e-mail: admin@dold.co.uk

### Finland

Sähkölehto OY  
Holkkitie 14  
FI-00880 Helsinki  
Phone: +358 9 7746420  
Fax: +358 9 7591071  
e-mail: office@sahkolehto.fi

### France

Dold Electric S.A.R.L.  
8 rue Renouvier  
F-67600 Selestat  
Phone: +33 3 88 92 98 64  
Fax: +33 3 88 92 97 01  
e-mail: m.riou@dold.fr  
d.palese@dold.fr

### Hungary

NTK Ipari Elektronikai és Kereskedelmi Kft  
postacím: 9001 Győr, Pf: 625  
HU-9023 Győr, Mészáros L.u.5  
Phone: +36 96 523268  
Fax: +36 96 430011  
e-mail: info@ntk-kft.hu

### India

Mrugit Diwanji  
B-3 Vishranti Heritage, Opp Yash Complex  
Off30meter Road, Gotri Road  
Vadodara - 390 021  
Phone +91 9909 001585  
E-Mail m.diwanji@dold.in

### Ireland

Dold Industries Ltd.  
11 Lamberts Rd. Blackall Ind.Estate,  
South Woodham Ferrers  
Essex, CM 3 5UW  
Phone: +44 1245 324432  
Fax: +44 1245 325570  
e-mail: admin@dold.co.uk

### Italy

Dold Italia S.r.l.  
Largo Donegani 2  
20121 Milano  
Mobil: + 39 346 2570556  
e-mail: dold-italia@dold.com

### Netherlands

forTop  
Automation & Energy Control  
Grote Kranerweerd 53  
NL-8065 PE Zwartsluis  
Phone +31 38-337 27 00  
Fax +31 38-337 27 09  
e-mail info@geveke-besturingstechnik.nl

### Norway

J.F. Knudtzen AS  
P.O. Box 160  
N- 1378 Nesbru  
Phone: +47 66983350  
Fax: +47 66980955  
e-mail: firmapost@jfknudtzen.no

### Poland

TEXIM SP. z o. o.  
Centrala  
ul. Wyspianskiego 66  
PL-83 000 Pruszcz Gdanski  
Phone: +48 58 6823684  
Fax: +48 58 6833260  
e-mail: texim@texim.pl

### Romania

SIV Electro Concept Srl.  
Bd. Theodor Pallady 40S  
RO 032266 Bucharest  
  
Phone: +40 742 149100  
e-mail: adrian.stroescu@sivelectro.ro

### Slovak Republic

OS-KOM spol.s.r.o.  
Zdikovská 22  
CZ 150 00 Praha 5 - Smichov  
Phone: +420 2 57210114  
Fax: +420 2 57211935  
e-mail: oskom@oskom.cz

### Slovenia

KOLEKTOR Sisteh d.o.o.  
Šlandrova ulica 10  
SI-1231 Ljubljana - Črnuče  
Phone: +386 5 3720650  
Fax: +386 5 3720660  
e-mail: info@synatec.si

### Spain

CONTAVAL S.L.  
Parque Tecnológico  
C/Benjamin Franklin no. 22  
E-46980-Paterna, Valencia  
Phone: +34 96 3843700  
Fax: +34 96 3840658  
e-mail: contaval@contaval.es

### Sweden

POWER AUTOMATION SWEDEN AB  
Cylindervägen 8  
P.O. Box 1193  
SE-131 27 Nacka Strand  
Phone: +46 8 402 04 50  
Fax: +46 8 402 04 59  
e-mail: info@powerautomation.se

### Switzerland

AWAG Elektrotechnik AG  
Sandbühlstr. 2  
CH-8604 Volketswil  
Phone: +41 44 9081919  
Fax: +41 44 9081999  
e-mail: info@awag.ch

### Turkey

DÖNÜSÜM  
Endüstri ve Otomasyon Mamülleri  
Atakoy 11. Kısım,  
2. Etap Konutları Zambak  
Apt. C Blok, No. 22  
34156 Bakirkoy-Istanbul  
Phone: +90 212 6618742  
Fax: +90 212 6618726  
e-mail: info@donusumtr.com

## Worldwide

### China

Dold Electric Taicang Co., Ltd.  
Rm. 316, Fuhua Building W,  
#6 West Beijing Rd.  
Taicang City, Juangsu Province  
P.R. China  
Phone +86 512 53206 226  
Fax +86 512 53206 228  
e-mail x.zhao@dold.com.cn

### Hong Kong

Peter, Charles & Co.  
2nd Floor, China Aerospace Centre  
143 Hoi Bun Road, Kwun Tong  
Kowloon, Hong Kong  
Phone: +852 23694050  
Fax: +852 27224080  
e-mail: bonnie@pcc.com.hk  
johnson@pcc.com.hk

### India

Mrugit Diwanji  
B-3 Vishranti Heritage, Opp Yash Complex  
Off30meter Road, Gotri Road  
Vadodara - 390 021  
Phone: +91 9909 001585  
e-mail: m.diwanji@dold.in

### Iran

Mehr Kanaz Co.  
No. 31, Koosha St. Shariati Ave.  
P.O. Box 19395  
4481 Teheran  
Phone: +98 21 22226994  
Fax: +98 21 22227851  
e-mail: ss@mehr-kanaz.com

### Singapore

Octogram Technologies Pte Ltd  
10 Ubi Crescent, #03-35  
Ubi Techpark, Lobby C  
Singapore 408564  
Phone: +65 67491518  
Fax: +65 6844 0335  
e-mail: shawn@octogram.com.sg

### Taiwan

Hunglin Technology Co., Ltd.  
466, Tong Hsin Rd., Sec.1  
408 Taichung Taiwan, R.O.C  
Phone: +886 4 24712177  
Fax: +886 4 2471-3165  
marco@hunglin.com  
www.hunglin.com

### USA

Altech Corp.  
35 Royal Road  
Flemington, NJ08822-6000  
Phone: 908 8069400  
Fax: 908 8069490  
e-mail: altech@altechcorp.com

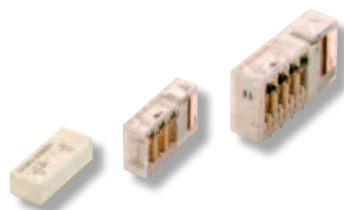

## Safety relays

Page 21

- with 4-6 or 4-8 contacts
- sensitive
- with double contacts
- with 2 contacts
- with 2 contacts, for high ambient temp. up to +85°C
- with reinforced insulation
- with 4 contacts

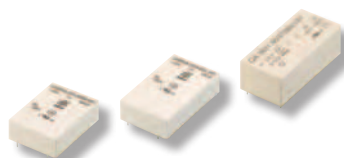

## PCB relays

Page 103

- monostable
- bistable



## Miniature relays

Page 127

- monostable
- monostable, SMD model
- bistable

Our catalogue includes an overview of all available PCB relays from Dold. In the first part you will find the relays with positive guided contacts. All safety relays correspond to DIN EN 50205 and are approved by TÜV Rheinland. Additionally the relays have an UL- approval.

In the second part you will find an overview of PCB- and miniature relays.

We would like to inform you that all relays mentioned in our catalogue are also available with other voltages, contact variants and combinations of different contact materials.

Of course, our products are ROHS compatible (Restriction of Hazardous Substances) and correspond to the legal standards of EU guideline 2002/95/EG including all changes from 01st July 2008.

If you have any questions regarding the suitable product for your application please do not hesitate to contact us.

All technical data in this list relate to the state at the moment of edition. We reserve the right for technical improvements and changes at any time.

# Table of contents

Function	Type	Page	Function	Type	Page
<b>General</b>			<b>Miniature relays</b>		
<b>Dold-Agents for PCB relays</b>		<b>4</b>	Power miniature relay		
<b>Product range</b>		<b>5</b>	- DILAIS ..... OA 5690.....		128
<b>Foreword</b>		<b>6</b>	- DILAIS ..... OB 5690.....		132
<b>Table of contents</b>		<b>7</b>	- DILAIS ..... OW 5691, OW 5699.....		136
<b>Company Presentation</b>		<b>8</b>	- DILAIS, SMD model.....	OW 5699.....	140
<b>List FE 54</b>			- DILAIS, Remanence .....	OR 5691 .....	144
- Safety relays with forcibly guided contacts		12			
- PCB relays		16			
- Miniature relays		18			
<b>Product selections</b>					
- Safety relays-		21			
- PCB relays		103			
- Miniature relays		127			
<b>General Conditions</b>					
<b>for the supply of products and services</b>		<b>148</b>			
<b>Safety relays</b>					
Safety relays					
- with 4 - 8 contacts	OA 5601, OA 5602, OA 5603.....	22			
- with 4 - 6 contacts	OA 5611, OA 5612.....	30			
- sensitive	OA 5611/12.../_/___S_.....	36			
- Signal relays	OA 5611.../_/31_ L1.....	42			
- with 4 - 6 contacts	OA 5621, OA 5622.....	47			
- with 8 contacts	OA 5623.....	55			
- with double contacts	OA 5621, OA 5622.....	61			
- bistable with 8 contacts	OB 5623.....	69			
- extremely smallest height only and minimum area	OA 5642, OA 5643, OA 5644.....	75			
- with 2 contacts	OA 5667.....	79			
- reinforced insulation	OA 5667/.../_/___4.....	83			
- with 2 contacts	OA / OW 5669.....	87			
- with 2 contacts for high ambient temp. up to +85°C	OA 5669.../_/3_... ..	92			
- with 4 contacts	OA 5670.....	97			
<b>PCB relays</b>					
PCB relays					
- monostable	OA 5651, OA 5652, OA 5261, OA 5662, OA 5692.....	104			
- monostable	OA 5661.12, OA 5662.12.....	109			
- monostable	OA 5671, OA 5681 OA 5672, OA 5682.....	113			
- monostable	OA / OW 5668.....	118			
- bistable	OB 5693, OB 5694 .....	122			



- Machinery and plant
- Power generation/distribution
- Oil and gas industry
- Automation
- Transport and material handling systems
- Rail technology
- Aviation/marine industry
- Paper and printing industry
- Food industry
- Rubber/plastics industry
- Heating and refrigeration
- Automotive
- Mining/metal working
- Chemical/pharmaceutical applications
- Medical technology
- Water/waste water treatment
- Cable cars/ski lifts

... and wherever safety has high priority.  
 We can cover your industrial applications as well!

# DOLD – Solutions for you



The DOLD philosophy, “Our experience. Your safety” constitutes our program: Offering solutions based on over 80 years of experience with a workforce of more than 400 employees, we manufacture high quality products using state-of-the-art production plant at our Furtwangen facility in Germany.

The comprehensive product range includes relay modules, safety relays with positively-driven contacts and electronic housings with virtually unparalleled production detail. The combination of know-how, innovation and experience makes us one of the leading worldwide manufacturers.

Apart from standard solutions, we are also the right partner when individual industrial solutions with that special touch are required.

Staying in close contact with our customers is very important to us. We listen, analyze and act by offering flexible, custom high-tech solutions, from a single source.

Thanks to our own development laboratory, highly automated production facilities with a modern tool & die shop in addition to injection moulding facility together with a well organized sales and marketing department, we guarantee high quality and short delivery times. Your benefits: Increased plant and machine availability, planning reliability and low production costs.

# Printed circuit board relays from DOLD

## DOLD PCB relays. Your solution provider.

DOLD is a family company based in the Black Forest town of Furtwangen and with over 80 years of experience, traditionally stands for "Made in Germany" quality.

DOLD is one of the leading manufacturers in the field of PCB relays and offers suitable electro-mechanical relays for a multitude of application fields. The comprehensive product portfolio encompasses miniature relays, PCB relays and safety relays with forcibly guided contacts.

As a specialist in PCB relays, we stand for quality and reliability from a single source. In order to meet the highest quality requirements, we rely on high production depth, the most up-to-date manufacturing equipment and the combination of experience and knowledge.

Our PCB relays are available in a great variety of different contact variants and construction forms and guarantee the highest switching safety with minimal dimensions.

DOLD relays are used throughout the world. They have the task of switching loads and galvanically separating electrical circuits. Classical applications, particularly for relays with mechanical forcibly guided contacts, are in the monitoring of emergency stop switches, safety doors or light barriers, for example. They are also essential in railway signalling equipment, in the controllers for passenger and goods elevators as well as in medical equipment. Wherever people and machines must be protected from injury and damage - DOLD relays are in use.

## Certified safety. Made in the Black Forest.

The expert knowledge of our personnel, the high level of production depth as well as the most modern production and testing systems are the prerequisites to be able to manufacture robust, reliable and high quality relays.

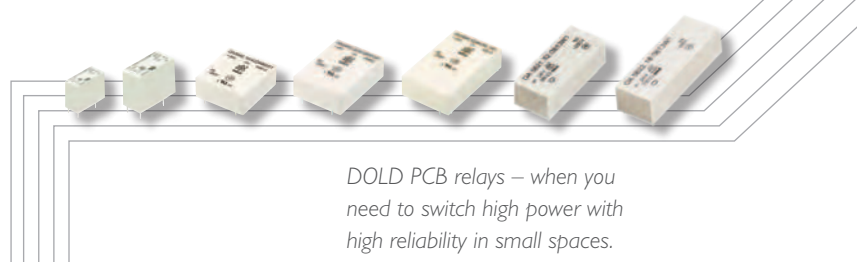
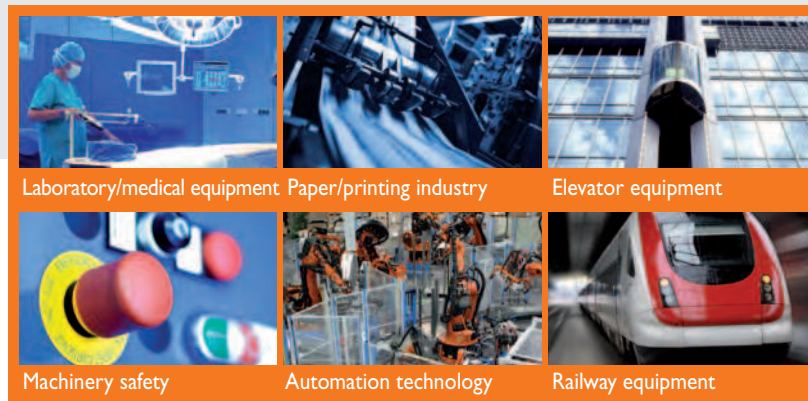
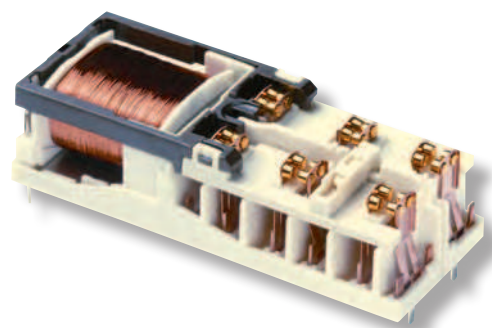

*DOLD PCB relays – when you need to switch high power with high reliability in small spaces.*



# The right relay - for every application

## Individual, customer-specific safety relays.

Partially equipped contact sets for increased insulation values, mixed contact equipping with single and double contacts as well as different contact materials for the loads to be switched require only a few minor adjustments for us to adapt our relays to individual, customer-specific requirements.

As a pioneer and technology leader for safety relays with forcibly guided contacts, PCB relays and miniature relays, we offer our customers technically advanced solutions for the secure switching of electrical power with minimal dimensions.

## Features that distinguish DOLD relays:

- ▶ Galvanic separation between control and load circuits
- ▶ Switching of loads up to 16 A with low nominal drive power
- ▶ Up to 8 contacts in one contact set
- ▶ Low contact transfer resistance
- ▶ Increased insulation values through partially equipped contact sets
- ▶ Energy efficiency through sensitive relays or bistable switching behaviour
- ▶ Smallest dimensions
- ▶ Suitable relay sockets for quick component replacement

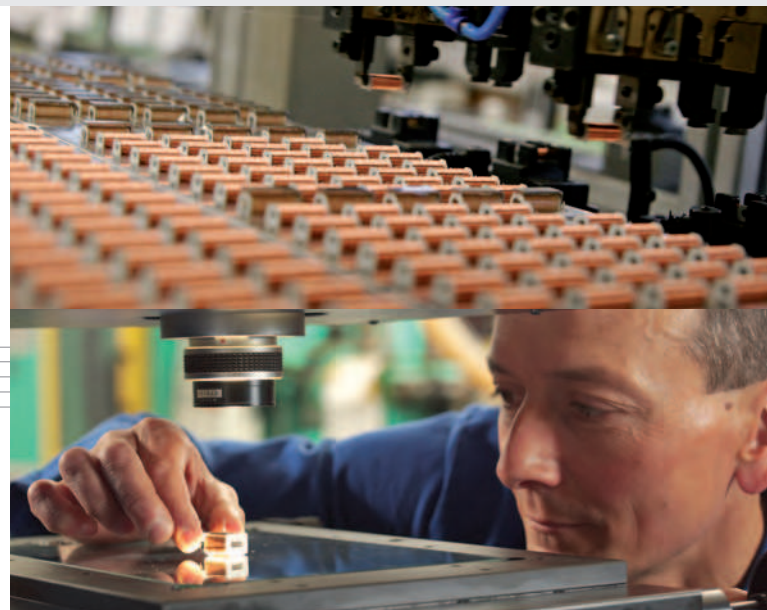
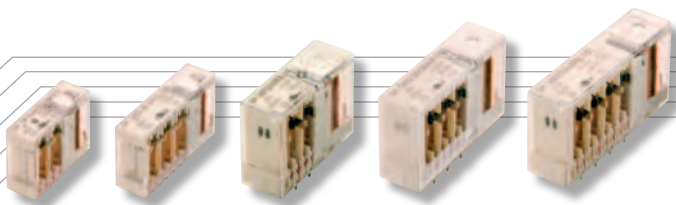

*A state-of-the-art machinery suite - that means highest process reliability, flexibility and quality.  
The expectations and needs of our customers are always the focus of our attention here.  
In doing so, we work with short information paths and the highest levels of professionalism.*

# Safety relays with forcibly guided contacts

Safety relays, i.e. relays with mechanically forcibly guided contacts per DIN EN 61810-3, are used wherever people, machines and valuable goods must be protected from injury and damage.



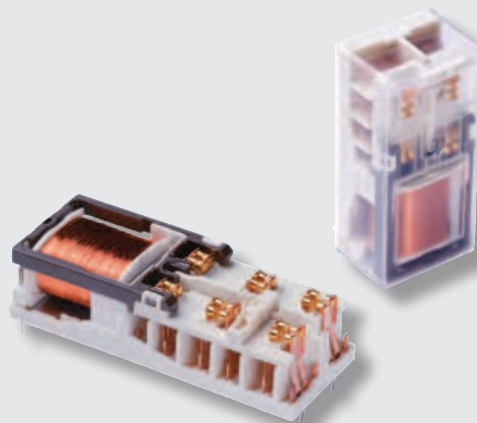

One such relay comprises at least one NC contact set and one NO contact set and is constructed such that the NC set and the NO set can never be closed at the same time. For example, if a NO contact fails when trying to open, the associated NC contact cannot close when the power supply is switched off.

This behaviour enables simple diagnostics and fault detection when monitoring the forcibly guided feedback contacts.

Relays with forcibly guided contacts are differentiated into two separate types. Type A describes relays where all contacts are mechanically linked to one another. Type B refers to relays with contacts that are linked to one another mechanically and contacts that are linked to one another in a non-mechanical manner.



Safety relays with forcibly guided contacts



					
Relays	Relay type	OA 5611	OA 5612	OA 5601	OA 5602
	Type of relay	Monostable	Monostable	Monostable	Monostable
Contacts	Contact equipping	4	6	4	6
	Contact material	AgSnO <sub>2</sub> ; AgNi	AgSnO <sub>2</sub> ; AgNi	AgSnO <sub>2</sub> ; AgNi	AgSnO <sub>2</sub> ; AgNi
	Limit continuous current I <sub>th max.</sub>	3 x 8 A	5 x 8 A	3 x 10 A	4 x 10 A
Coils	Nominal voltage U <sub>N</sub>	DC 6 - 110 V	DC 6 - 110 V	DC 6 - 110 V	DC 6 - 110 V
	Voltage range	0.7 - 1.4 U <sub>N</sub>	0.7 - 1.4 U <sub>N</sub>	0.7 - 1.6 U <sub>N</sub>	0.7 - 1.6 U <sub>N</sub>
Insulation	Test voltage (AC) Contact set - coil	≥ 4 kV <sub>eff</sub>	≥ 4 kV <sub>eff</sub>	≥ 4 kV <sub>eff</sub>	≥ 4 kV <sub>eff</sub>
	Clearance and creepage distances, contact set - coil	≥ 8 mm	≥ 8 mm	≥ 8 mm	≥ 8 mm
Other data	Temperature range	- 40 ... + 85 °C	- 40 ... + 85 °C	- 40 ... + 85 °C	- 40 ... + 85 °C
	Type per DIN EN 61810-3	A	A	A	A
	Protection type	RT II (flux-proof relay), optional RT III (wash-tight)	RT II (flux-proof relay), optional RT III (wash-tight)	RT II (flux-proof relay), optional RT III (wash-tight)	RT II (flux-proof relay), optional RT III (wash-tight)
	Size L x W x H [mm]	41.9 x 14.5 x 30.5	51.5 x 14.5 x 30.5	57 x 20 x 39.5	67 x 20 x 39.5
	Approvals	TÜV, cRUus	TÜV, cRUus	TÜV, cRUus	TÜV, cRUus

DOLD safety relays are available in vertical and horizontal designs and offer up to 8 mechanically forcibly guided contacts. With different construction forms, contact materials and also with partially equipped contact sets if required, we offer you maximum flexibility.

Types **OA 5601**, **OA 5602** and **OA 5603** with 4, 6 or 8 contacts are rated for max. continuous currents up to 10 A. It is also possible to choose between single contacts and double contacts for challenging tasks with the **OA 5621** and **OA 5622** relays.

With DOLD you can always switch safe and reliably. You can find more detailed information on our PCB relays at [www.dold.com](http://www.dold.com).

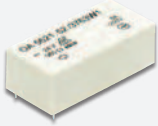
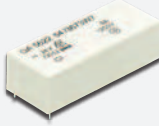

						
<b>OA 5603</b>	<b>OA 5621</b>	<b>OA 5621 With twin contacts</b>	<b>OA 5622</b>	<b>OA 5622 With twin contacts</b>	<b>OA 5623</b>	
Monostable	Monostable	Monostable	Monostable	Monostable	Monostable	
8	4	4	6	6	8	
AgSnO <sub>2</sub> ; AgNi	AgSnO <sub>2</sub> ; AgNi	AgNi + 5 µm Au	AgSnO <sub>2</sub> ; AgNi	AgNi + 5 µm Au	AgNi	
6 x 10 A	3 x 8 A	3 x 5 A	5 x 8 A	5 x 5 A	7 x 8 A	
DC 6 - 110 V	DC 6 - 110 V	DC 6 - 110 V	DC 6 - 110 V	DC 6 - 110 V	DC 6 - 110 V	
0.7 - 1.6 U <sub>N</sub>	0.75 - 1.4 U <sub>N</sub>	0.75 - 1.2 U <sub>N</sub>	0.75 - 1.4 U <sub>N</sub>	0.75 - 1.2 U <sub>N</sub>	0.75 - 1.2 U <sub>N</sub>	
≥ 4 kV <sub>eff</sub>	≥ 4 kV <sub>eff</sub>	≥ 4 kV <sub>eff</sub>	≥ 4 kV <sub>eff</sub>	≥ 4 kV <sub>eff</sub>	≥ 4 kV <sub>eff</sub>	
≥ 8 mm	≥ 5.5 mm	≥ 5.5 mm	≥ 5.5 mm	≥ 5.5 mm	≥ 5.5 mm	
- 40 ... + 75 °C	- 40 ... + 80 °C	- 40 ... + 80 °C	- 40 ... + 80 °C	- 40 ... + 80 °C	- 40 ... + 80 °C	
A	A	A	A	A	A	
RT II (flux-proof relay), optional RT III (wash-tight)	RT III (wash-tight)	RT III (wash-tight)	RT III (wash-tight)	RT III (wash-tight)	RT III (wash-tight)	
77.1 x 20 x 39.5	46.5 x 22 x 15.5	46.5 x 22 x 15.5	55 x 22 x 15.5	55 x 22 x 15.5	67 x 22 x 15.8	
TÜV, cRUus	TÜV, cRUus	TÜV, cRUus	TÜV, cRUus	TÜV, cRUus	TÜV, cRUus	

# Safety relays with forcibly guided contacts

Relays with mechanically forcibly guided contacts are used in safety relay modules or controllers amongst other things. The simplicity in the use of safety relays makes them the ideal component for detecting faults due to the forced driving of NC and NO contacts without the need for complex circuitry. In these safety relevant applications, particular attention is paid to the compact form alongside the high degree of switching security.

At just 10.3 mm height, the extremely flat relay family **OA 5642**, **OA 5643** and **OA 5644** with 2, 3 or 4 contacts takes account of the desire for components to be ever smaller and more compact. In doing so, the limits of the miniaturisation of electro-mechanical relays are determined primarily by the necessary clearance and creepage distances.

DOLD safety relays are known for their robustness and reliability and at the same time are extremely energy efficient. The sensitive design of the **OA 5643** relay with three contacts exhibits a nominal power of just 330 mW.

With the narrow emergency stop module, DOLD sets new standards in the miniaturisation of safety switching devices. Its installation width is just 17.5 mm and this with a device depth less than 70 mm. Because the space in the switch cabinets is becoming ever more precious, DOLD offers further opportunities for savings with this solution.

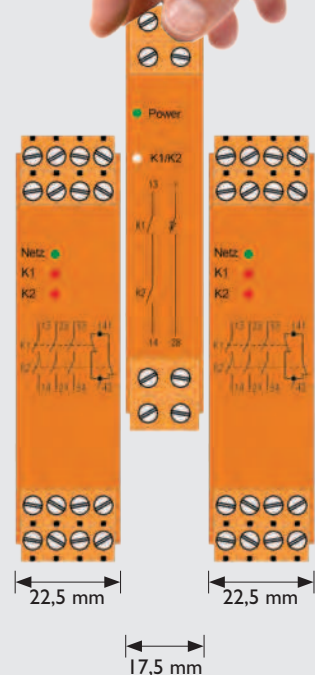

## Safety relays with forcibly guided contacts

				
<b>Relay type</b>	Relay type	<b>OA 5642 *</b>	<b>OA 5643 **</b>	<b>OA 5644</b>
	Type of relay	Monostable	Monostable	Monostable
<b>Contacts</b>	Contact equipping	2	3	4
	Contact material	AgSnO <sub>2</sub> ; AgNi	AgSnO <sub>2</sub> ; AgNi	AgSnO <sub>2</sub> ; AgNi
	Limit continuous current I <sub>th</sub> max.	8	8	8
<b>Coils</b>	Nominal voltage U <sub>N</sub>	DC 6 - 110 V	DC 6 - 110 V	DC 6 - 110 V
	Voltage range	0.7 - 1.6 U <sub>N</sub>	0.7 - 1.6 U <sub>N</sub>	0.7 - 1.6 U <sub>N</sub>
<b>Insulation</b>	Test voltage (AC) Contact set - coil	≥ 4 kV <sub>eff</sub>	≥ 4 kV <sub>eff</sub>	≥ 4 kV <sub>eff</sub>
	Clearance and creepage distances, contact set - coil	≥ 5.5 mm	≥ 5.5 mm	≥ 5.5 mm
<b>Other data</b>	Temperature range	- 40 ... + 85 °C	- 40 ... + 85 °C	- 40 ... + 85 °C
	Type per DIN EN 61810-3	A	A	A
	Protection type	RT III (wash-tight)	RT III (wash-tight)	RT III (wash-tight)
	Size L x W x H [mm]	26.6 x 25 x 10.3	34.2 x 25 x 10.3	41.7 x 25 x 10.3
	Approvals	TÜV, cRUus	TÜV, cRUus	TÜV, cRUus

\*) Sensitive model with 250 mW nominal power

\*\*) Sensitive model with 330 mW nominal power



Sockets for PCB mounting are available for almost all safety relays. These enable the safety relays to be quickly replaced during preventative maintenance. In addition, sockets are also available for DIN rail mounting.

Typical areas of application are:

- ▶ Railway equipment
- ▶ Lift controllers
- ▶ Combustion technology
- ▶ Automation and process technology
- ▶ Medical equipment
- ▶ Materials handling

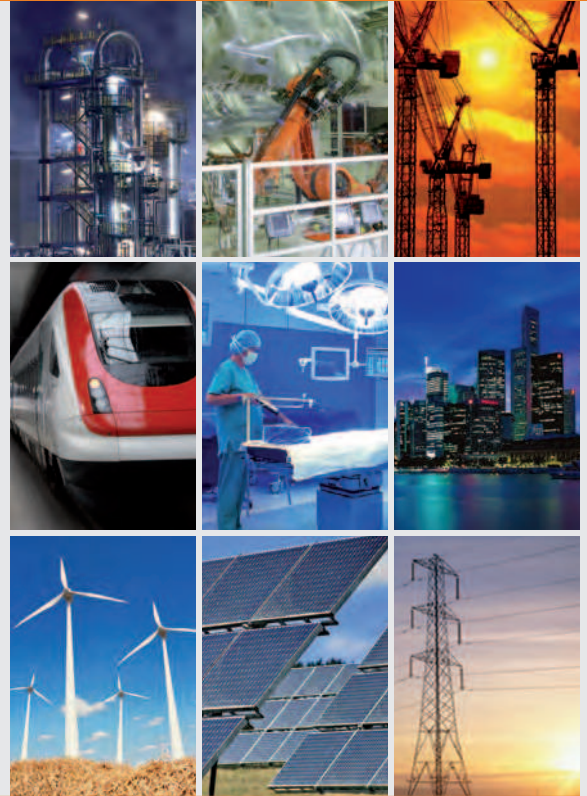
With DOLD you can always switch safe and reliably. You can find more detailed information on our PCB relays at [www.dold.com](http://www.dold.com).

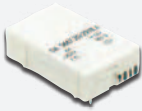

			
<b>OA 5667</b>	<b>OA 5669</b>	<b>OA 5670</b>	
Monostable	Monostable	Monostable	
2	2	4	
AgSnO <sub>2</sub> ; AgNi	AgSnO <sub>2</sub> ; AgNi	AgSnO <sub>2</sub> ; AgNi	
2 x 6 A	2 x 5 A	3 x 6 A	
DC 6 - 110 V	DC 6 - 110 V	DC 6 - 110 V	
0.75 - 1.3 U <sub>N</sub>	0.8 - 1.6 U <sub>N</sub>	0.7 - 1.4 U <sub>N</sub>	
≥ 4 kV <sub>eff</sub>	≥ 4 kV <sub>eff</sub>	≥ 4 kV <sub>eff</sub>	
≥ 8 mm	≥ 8 mm	≥ 8 mm	
- 40 ... + 85 °C	- 40 ... + 85 °C	- 40 ... + 75 °C	
A / B	A / B	A	
RT II (flux-proof relay)	RT II (flux-proof relay), optional RT III (wash-tight)	RT II (flux-proof relay), optional RT III (wash-tight)	
37 x 25 x 10.8	29 x 13 x 25.5	35 x 13 x 25.5	
TÜV, cRUus	TÜV, cRUus	TÜV, cRUus	

# PCB relays

PCB relays, also known as plug-in/print relays, are used for galvanic separation of circuits as well as for signal adaptation and signal strengthening. Our vertical and horizontal designs enable optimum adaptation to your application.

Whilst the contacts of the monostable PCB relays return to their original switch position after the excitation power is switched off, with bistable relays **OB 5693** and **OB 5694** the switching position is retained after the excitation power is switched off. Energy is thus required only briefly to change the switching position. Because the bistable relays require only a fraction of the energy required by monostable solutions, they are the preferred choice in energy-efficient and battery-powered systems. The characteristic of retaining the switching position in the event of the power supply failing, is essential in certain applications.

DOLD PCB relays, with max. continuous currents up to 16 A, are available with one or two contacts, in different installation heights and with different contact materials.

DOLD relays are suitable for inserting into relay sockets or for soldering into PCBs. The combination of plug-in sockets and relays enables rapid replacement during maintenance or in the event of a service call.



## PCB relays

					
<b>Relay</b>	Relay type	<b>OA 5651 / OA 5661</b>	<b>OA 5652 / OA 5662 / OA 5692</b>	<b>OA 5661.12</b>	<b>OA 5662.12</b>
	Type of relay	Monostable	Monostable	Monostable	Monostable
<b>Contacts</b>	Contact equipping	1	1	2	2
	Contact material	AgSnO <sub>2</sub> ; AgNi	AgSnO <sub>2</sub> ; AgNi	AgSnO <sub>2</sub> ; AgNi	AgSnO <sub>2</sub> ; AgNi
	Limit continuous current I <sub>th</sub> max.	8 A	8 A	2 x 6 A	2 x 6 A
<b>Coils</b>	Nominal voltage U <sub>N</sub>	DC 6 - 60 V	DC 6 - 60 V	DC 6 - 60 V	DC 6 - 60 V
	Voltage range	0.7 - 1.8 U <sub>N</sub>	0.7 - 1.8 U <sub>N</sub>	0.7 - 1.4 U <sub>N</sub>	0.7 - 1.4 U <sub>N</sub>
<b>Insulation</b>	Test voltage (AC) Contact set - coil	≥ 4 kV <sub>eff</sub>	≥ 4 kV <sub>eff</sub>	≥ 4 kV <sub>eff</sub>	≥ 4 kV <sub>eff</sub>
	Clearance and creepage distances, contact set - coil	≥ 8 mm	≥ 8 mm	≥ 8 mm	≥ 8 mm
<b>Other data</b>	Temperature range	- 40 ... + 80 °C	- 40 ... + 80 °C	- 40 ... + 70 °C	- 40 ... + 70 °C
	Protection type	RT II (flux-proof relay)	RT II (flux-proof relay)	RT II (flux-proof relay)	RT II (flux-proof relay)
	Size L x W x H [mm]	28 x 25 x 10.8 mm	28 x 10.8 x 25 mm	37 x 25 x 10.8 mm	37 x 10.3 x 25 mm
	Approvals	cRUus	cRUus	cRUus	cRUus

\* only OA 5681





\*\* only OA5682

Typical areas of application are:

- ▶ Building automation
- ▶ Installation technology
- ▶ Energy technology
- ▶ Remote switching
- ▶ Staircase timers

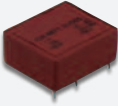
With DOLD you can always switch safe and reliably. You can find more detailed information on our PCB relays at [www.dold.com](http://www.dold.com).



				
<b>OA 5668 / OW 5668</b>	<b>OA 5671 / OA 5681</b>	<b>OA 5672 / OA 5682</b>	<b>OB 5693</b>	<b>OB 5694</b>
Monostable	Monostable	Monostable	Bistable	Bistable
2	1	1	1	1
AgSnO <sub>2</sub> ; AgNi	AgSnO <sub>2</sub>	AgSnO <sub>2</sub>	AgSnO <sub>2</sub> ; AgNi	AgSnO <sub>2</sub> ; AgNi
2 x 5 A	10 A / 16 A*	10 A / 16 A**	16 A	16 A
DC 5 - 110 V	DC 6 - 110 V	DC 6 - 110 V	DC 6 - 110 V ; AC 12 - 230 V	
0.7 - 2.0 U <sub>N</sub>	0.7 - 2.2 U <sub>N</sub>	0.7 - 2.2 U <sub>N</sub>	0.8 - 1.1 U <sub>N</sub>	0.8 - 1.1 U <sub>N</sub>
≥ 4 kV <sub>eff</sub>	≥ 4 kV <sub>eff</sub>	≥ 4 kV <sub>eff</sub>	≥ 4 kV <sub>eff</sub>	≥ 4 kV <sub>eff</sub>
≥ 8 mm	≥ 8 mm	≥ 8 mm	≥ 8 mm	≥ 8 mm
- 40 ... + 75 °C	- 40 ... + 110 °C	- 40 ... + 110 °C	- 40 ... + 75 °C	- 40 ... + 75 °C
RT II (flux-proof relay), optional RT III (wash-tight)	RT II (flux-proof relay)	RT II (flux-proof relay)	RT II (flux-proof relay), optional RT III (wash-tight)	RT II (flux-proof relay), optional RT III (wash-tight)
29 x 13 x 25.5 mm	29 x 25 x 12.5 mm	29 x 12 x 25.5 mm	28 x 25 x 10.8 mm	28 x 10 x 26 mm
-	cRUus*	cRUus	-	-

# Miniature relays

If it is necessary to switch heavy currents reliably in a small space and galvanic separation of control and load circuits is also required, there is no better answer than the compact miniature power relays available in SMD (Surface Mount Device) form and in DIL (Dual In-Line) form. With the smallest of dimensions, at around 20 mm long and 10 mm wide, they can be inserted into conventional 16-pole IC-sockets.

The **OW 5691** and **OW 5699** relays also have an installation height of just 12.15 mm and can fit almost any situation.



The distinguishing features of the wash-tight miniature relays known by the DILAIS brand, are their high switching power, the large operating voltage range and their reliability.

All miniature relays can be selected as NO design or with changeover contacts. A great variety of different technologies, contact materials and contact equipping prove their strengths in diverse applications.

Thus the monostable miniature **OA 5690** power relays are always used wherever there are high requirements on galvanic separation between control circuits and load circuits. Clearance and creepage distances  $\geq 8$  mm between coil and contacts as well as low coupling capacitance make this relay the ideal component.

The miniature **OB 5690** bistable power relays, which retain their switching position after the excitation power is removed or after a power supply failure, are particularly well suited to use in energy-efficient and battery-powered circuitry. Only a short control pulse is required to change the switching position.

## Miniature relays

				
<b>Relay</b>	Relay type	<b>OW 5691 / OW 5699</b>	<b>OW 5699</b>	<b>OW 5699 SMD</b>
	Type of relay	Monostable	Monostable	Monostable
<b>Contacts</b>	Contact equipping	1	1	1
	Contact material	AgSnO <sub>2</sub> ; AgNi	AgSnO <sub>2</sub> ; AgNi	AgSnO <sub>2</sub> ; AgNi
	Limit continuous current I <sub>th</sub> max.	5 A	8 A	5 A
<b>Coils</b>	Nominal voltage U <sub>N</sub>	DC 4.5 - 48 V	DC 4.5 - 48 V	DC 4.5 - 48 V
	Voltage range	0.75 - 2.2 U <sub>N</sub>	0.75 - 1.6 U <sub>N</sub>	0.75 - 1.6 U <sub>N</sub>
<b>Insulation</b>	Test voltage Contact set - coil	$\geq 4$ kV <sub>eff</sub>	$\geq 4$ kV <sub>eff</sub>	$\geq 4$ kV <sub>eff</sub>
	Clearance and creepage distances Contact set - coil	$\geq 5.5$ mm	$\geq 5.5$ mm	$\geq 5.5$ mm
<b>Other data</b>	Temperature range	- 40 ... + 80 °C	- 40 ... + 80 °C	- 40 ... + 80 °C
	Protection type	RT III (wash-tight)	RT III (wash-tight)	RT III (wash-tight)
	Size L x W x H	20.2 x 10.1 x 12.15	20.2 x 10.1 x 12.15	20.2 x 10.1 x 13.5
	Approvals	VDE, cRUus	VDE, cRUus	cRUus



With the remanence relay **OR 5691**, the contacts remain in the working position after a current pulse by using the existing residual magnetism (remanence) until a reduced pulse is applied in the opposite current flow direction. As a result, this relay is also used if the self-heating of the coil and the energy consumption have to be reduced to a minimum.



Typical areas of application are:

- ▶ Automation and process technology
- ▶ Measurement and monitoring technology
- ▶ Installation and energy technology

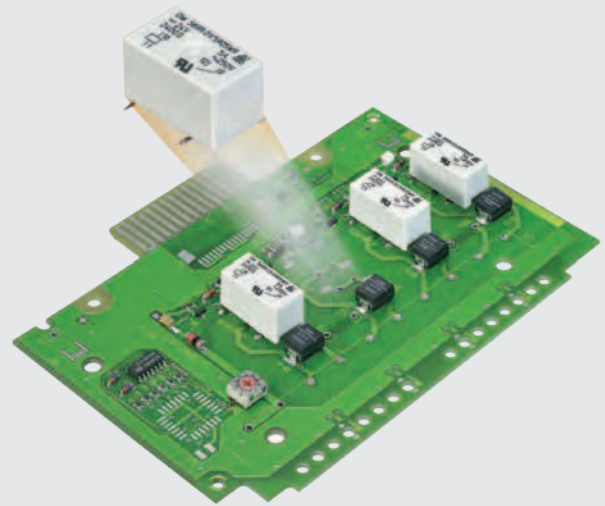
With DOLD you can always switch safe and reliably. You can find more detailed information on our PCB relays at [www.dold.com](http://www.dold.com).



The miniature relays from DOLD are distinguished through their small dimensions with high power and reliability. These mini-relays measure just 10 x 20 x 12 mm. Nonetheless, the switch contacts can easily deal with a continuous current of up to 8 A. In addition, the user can choose between different contact materials and contact designs.

				
	<b>OA 5690</b>	<b>OB 5690</b>	<b>OR 5691</b>	
	Monostable	Bistable	Remanence	
	1	1	1	
	AgSnO <sub>2</sub> ; AgNi	AgSnO <sub>2</sub> ; AgNi	AgSnO <sub>2</sub> ; AgNi	
	5 A; 10 A	5 A	5 A	
	DC 4.5 - 48 V	DC 4.5 - 48 V	DC 4.5 - 48 V	
	0.75 - 2.0 / 1.8 U <sub>N</sub>	0.75 - 1.9 U <sub>N</sub>	0.8 - 1.3 U <sub>N</sub>	
	≥ 4 kV <sub>eff</sub>	≥ 4 kV <sub>eff</sub>	≥ 4 kV <sub>eff</sub>	
	≥ 8 mm	≥ 8 mm	≥ 5.5 mm	
	- 40 ... + 80 °C	- 40 ... + 80 °C	- 40 ... + 65 °C	
	RT III (wash-tight)	RT III (wash-tight)	RT III (wash-tight)	
	20.2 x 10 x 16.5	20.2 x 10 x 16.5	20.2 x 10.1 x 12.15	
	cRUus	-	cRUus	



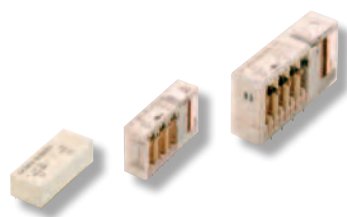

## Safety relays

- with 4-6 or 4-8 contacts
- sensitive
- with double contacts
- with 2 contacts
- with 2 contacts, for high ambient temp. up to +85°C
- with reinforced insulation
- with 4 contacts

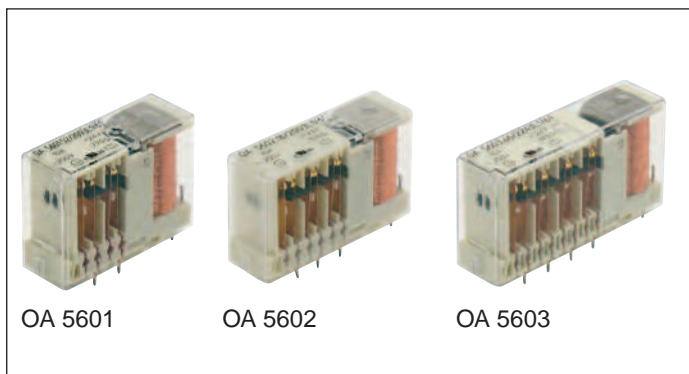

- According to DIN EN 61810-1, DIN EN 61810-3
- With forcibly guided contacts
- High switching reliability due to crown contacts
- Clearance and creepage distances:  
contact - coil  $\geq 8$  mm  
contact - contact  $\geq 5.5$  mm
- **Double and reinforced insulation with pollution degree 2**
- Overvoltage category: III
- High voltage resistance  $\geq 4$  kV
- High mechanical service life
- High temperature range  
at OA 5601 and OA 5602:  $-40 \dots +85^\circ\text{C}$   
at OA 5603:  $-40 \dots +75^\circ\text{C}$
- High continuous thermal current  $I_{th} = 10$  A
- High voltage range  $0.7 \dots 1.6 U_N$
- As option wash proof RT III

### Application

- To be used in circuits for safety applications
- Escalators and walkways
- Elevators for men and load
- Railway technology
- Medical technology

### Approvals and Markings



### Technical Data

Relay type		OA 5601	OA 5602	OA 5603
<b>1.0 Coil</b>				
1.1 Nominal voltage	DC V	6, 12, 24, 48, 60, 110 (others on request)		
1.2 Nominal consumption	W	0.75	1	1.25 <sup>1)</sup>
1.11 Voltage range	$U_N$	0.7 ... 1.6	0.7 ... 1.6	0.7 ... 1.6
1.3 Holding power (at $0.5 \times U_N$ )		0.19	0.25	0.32
<b>2.0 Contacts</b>				
2.1 Contact arrangement		2 NO / 2 NC 3 NO / 1 NC	2 NO / 4 NC 3 NO / 3 NC 4 NO / 2 NC	7 NO / 1 NC : 2 NO / 6 NC
2.2 Contact material		AgSnO <sub>2</sub> + 0.2 $\mu\text{m}$ Au; AgNi + 0.2 $\mu\text{m}$ Au, AgNi + 5 $\mu\text{m}$ Au		
2.3 Rated insulation voltage	AC V	250		
Switching voltage min./max.	V	AC/DC 10 / DC 250, AC 400 (AC/DC 2 V / AC/DC 60 V) <sup>2)</sup>		
2.4 Limiting continuous current $I_{th}$ max.	A	6 x 10 (see operating voltage limit curve)		
Switching current min./max.	A	10 mA <sup>4)</sup> / 10 A (2 mA / 0.3 A) <sup>2)</sup>		
2.5 Switching power min./max.	VA	0,1 / 2500 (10 mVA / 12 VA) <sup>2)</sup>		
Switching power min./max.	W	0.1 <sup>4)</sup> ... 240 (10 mW / 12 W) <sup>2)</sup> (see limit curve for arc-free operation)		
2.6 Switching capacity to IEC/EN 60947-5-1				
AC 15 <sup>5)</sup>			NO: 250 / 3    NC: 250 / 2	
AC 15 <sup>6)</sup>	AC V/A		NO: 250 / 5    NC: 250 / 2	
DC 13 <sup>5)</sup>	DC V/A		NO: 24 / 2    NC: 24 / 2	
DC 13 <sup>5)</sup> at 0.1 Hz	DC V/A		NO: 24 / 6    NC: 24 / 6	
to UL 508			A300	
2.7 Electrical life		at 1 s ON, 1 s OFF (see contacts service life)		
at AC 230 V, 6 A, $\cos\phi = 1$	switching cycles	$> 7 \times 10^5$ , AgSnO <sub>2</sub> / $> 5 \times 10^5$ , AgNi10		
at AC 230 V, 10 A, $\cos\phi = 1$	switching cycles	$> 5 \times 10^5$ , AgSnO <sub>2</sub> / $> 4 \times 10^5$ , AgNi10		
2.8 Switching frequency max.	switching cycles/s	10		
2.9 Response time / Release time	ms	typically 27 / typically 5		
2.10 Contact force	cN	$\geq 14$		
2.14 Contact gap	mm	$> 1$ (normal operation) / $> 0.5^3)$		
<b>3.0 Other</b>				
3.1 Mechanical life	switching cycles	$> 30 \times 10^6$		
3.2 Temperature range	$^\circ\text{C}$	- 40 ... + 85	- 40 ... + 85	- 40 ... + 75
3.3 Degree of protection		Solder line proof RT II as option wash proof RT III		
3.5 Vibration resistance		10 ... 55 Hz, 0.35 mm Ampl.; 5 g max. IEC/EN 60068-2-6		
3.4 Test procedure		A (group mounting)		
3.6 Climate resistance		40 / 085 / 04; A / B / D IEC/EN 60068-1		
3.7 Short circuit strength 1 kA / AC 250 V	AgSnO <sub>2</sub> AgNi	NO: 10 A gL / NC: 10 A gL IEC/EN 60947-5-1 NO: 10 A gL / NC: 6 A gL IEC/EN 60947-5-1		

<sup>1)</sup> For OA 5603.46 (2 NO / 6 NC) and OA 5603.56 (3 NO / 5 NC) nominal consumption is 1.65 W

<sup>2)</sup> Values for AgNi10-Contacts + 5  $\mu\text{m}$  Au

<sup>3)</sup> over entire service life, even when under fault and at  $1.6 U_N$

<sup>4)</sup> Typical values for AgSnO<sub>2</sub> and AgNi

<sup>5)</sup> Values for AgNi-Contacts

<sup>6)</sup> Values for AgSnO<sub>2</sub>-Contacts

## Technical Data

3.8	Insulation acc. to IEC 60664-1, EN 50178			
	Rated insulation voltage	AC V		250
	Pollution degree			3 / 2 (double and reinforced insulation)
	Overvoltage category			III
	Test voltage			
	Contact- Coil (1 min)	AC kV eff.		≥ 4
	Contact-Contact (1min)	AC kV eff.		≥ 4
	Open contact acc. to DIN EN 61810-1	AC kV eff.		1.5
	Transient voltage			
	Contact- Coil (1,2 - 50 μs)	kV		≥ 6
	Clearance and creepage distances			
	Contact- Coil	mm		≥ 8
	Contact-Contact	mm		≥ 5.5
3.9	Weight	g	approx. 78	approx. 85 approx. 95
<b>4.0 Packing</b>				
4.1	on cardboard in slipcase	piece	20	15 15
4.2	in case package	piece	100	75 75
<b>5.0 Solder method</b>				
5.1	Solder method /-temperature /-duration	°C / s	Wafer soldering / 260 / 5	

## Design versions

U <sub>N</sub> (DCV)	Voltage range (DC V)	OA 5601			OA 5602			OA 5603						
		R <sub>Coil</sub> Ω±10%	.52 2 NO, 2 NC	.48 3 NO, 1 NC	R <sub>Coil</sub> Ω±10%	.18 3 NO, 3 NC	.50 2 NO, 4 NC	.54 4 NO, 2 NC	R <sub>Coil</sub> Ω±10%	.63 7 NO, 1 NC	.59 6 NO, 2 NC	.58 5 NO, 3 NC	.57 4 NO, 4 NC	R <sub>Coil</sub> Ω±10%

AgSnO<sub>2</sub>-Contacts + 0.2 μm Au

6	4,2 ... 9,6	48	2091	2121	35	2001	2031	2061	29	2151	2181	2271	2211	21	2301	2241
12	8,4 ... 19,2	192	2092	2122	140	2002	2032	2062	112	2152	2182	2272	2212	88	2302	2242
24	16,8 ... 38,4	770	2093	2123	570	2003	2033	2063	460	2153	2183	2273	2213	370	2303	2243
48	33,6 ... 76,8	2880	2094	2124	2300	2004	2034	2064	1800	2154	2184	2274	2214	1400	2304	2244
60	42,0 ... 96,0	4800	2095	2125	3600	2005	2035	2065	2880	2155	2185	2275	2215	2230	2305	2245
110	77,0 ... 176,0	16000	2096	2126	12100	2006	2036	2066	9500	2156	2186	2276	2216	7150	2306	2246

AgNi 10-Contacts + 0.2 μm Au

6	4,2 ... 9,6	48	2101	2131	35	2011	2041	2071	29	2161	2191	2281	2221	21	2311	2251
12	8,4 ... 19,2	192	2102	2132	140	2012	2042	2072	112	2162	2192	2282	2222	88	2312	2252
24	16,8 ... 38,4	770	2103	2133	570	2013	2043	2073	460	2163	2193	2283	2223	370	2313	2253
48	33,6 ... 76,8	2880	2104	2134	2300	2014	2044	2074	1800	2164	2194	2284	2224	1400	2314	2254
60	42,0 ... 96,0	4800	2105	2135	3600	2015	2045	2075	2880	2165	2195	2285	2225	2230	2315	2255
110	77,0 ... 176,0	16000	2106	2136	12100	2016	2046	2076	9500	2166	2196	2286	2226	7150	2316	2256

AgNi 10-Contacts + 5 μm Au

6	4,2 ... 9,6	48	2111	2141	35	2021	2051	2081	29	2171	2201	2291	2231	21	2321	2261
12	8,4 ... 19,2	192	2112	2142	140	2022	2052	2082	112	2172	2202	2292	2232	88	2322	2262
24	16,8 ... 38,4	770	2113	2143	570	2023	2053	2083	460	2173	2203	2293	2233	370	2323	2263
48	33,6 ... 76,8	2880	2114	2144	2300	2024	2054	2084	1800	2174	2204	2294	2234	1400	2324	2264
60	42,0 ... 96,0	4800	2115	2145	3600	2025	2055	2085	2880	2175	2205	2295	2235	2230	2325	2265
110	77,0 ... 176,0	16000	2116	2146	12100	2026	2056	2086	9500	2176	2206	2296	2236	7150	2326	2266

## Ordering example

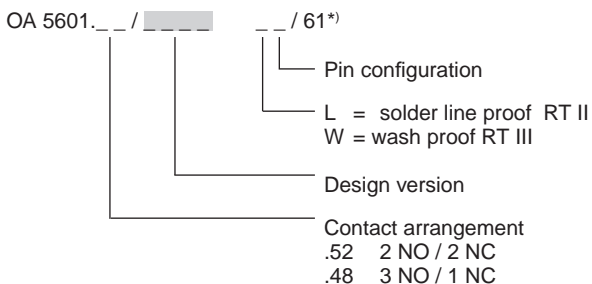

\*) / 61 cURus approval

Characteristics

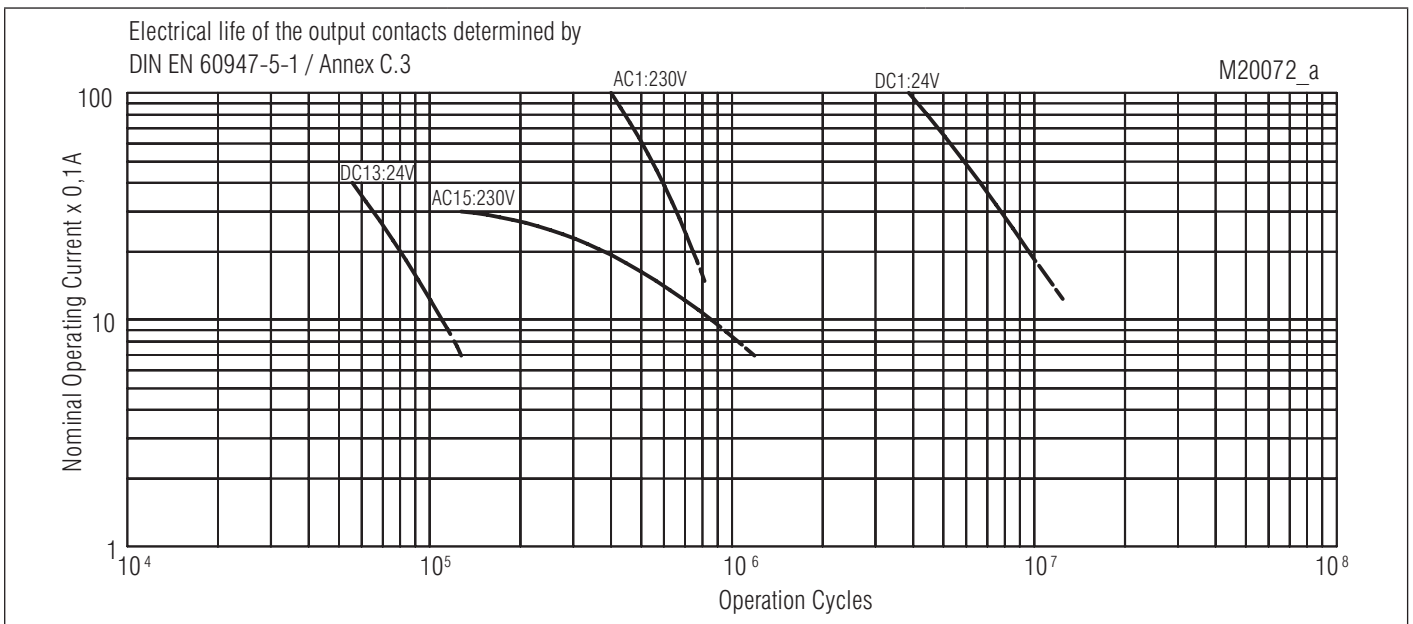
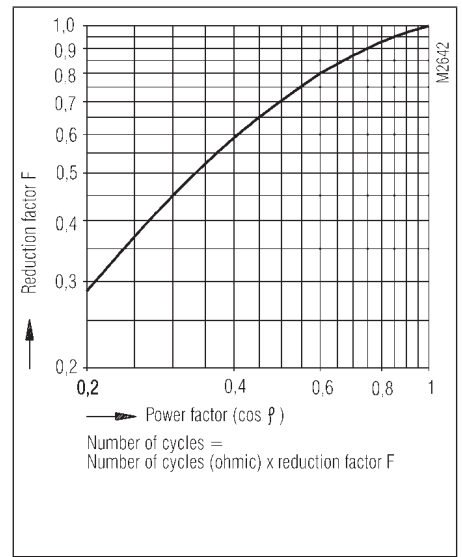
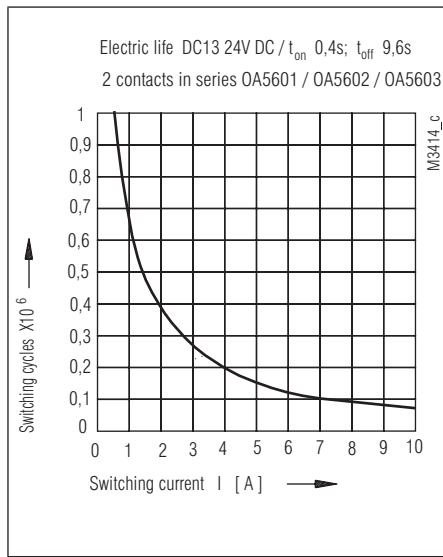
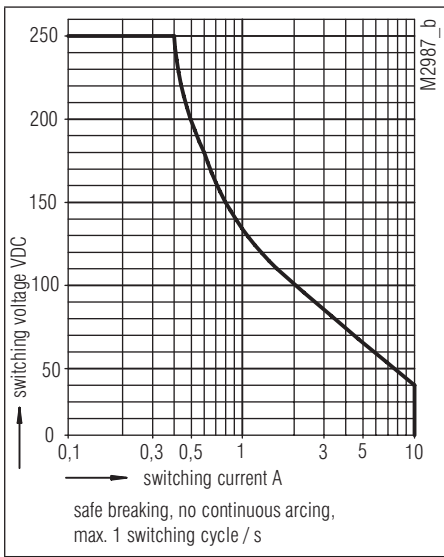
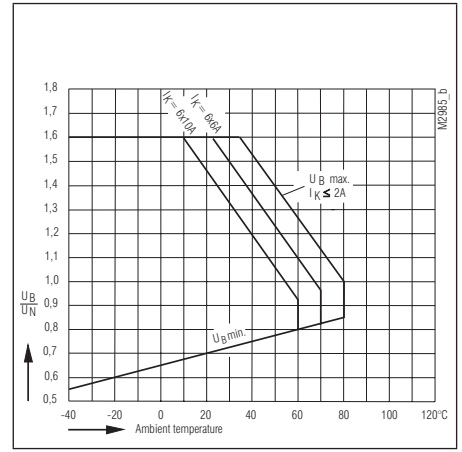
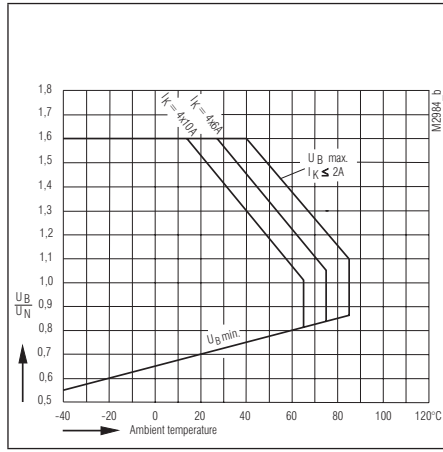
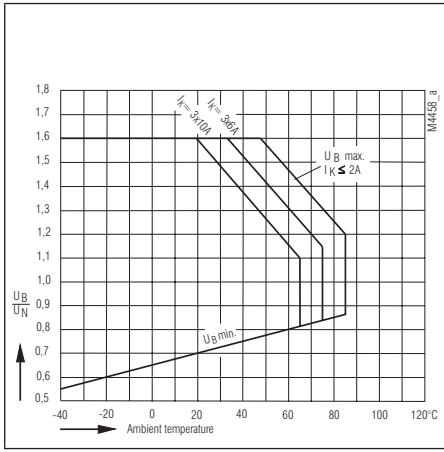

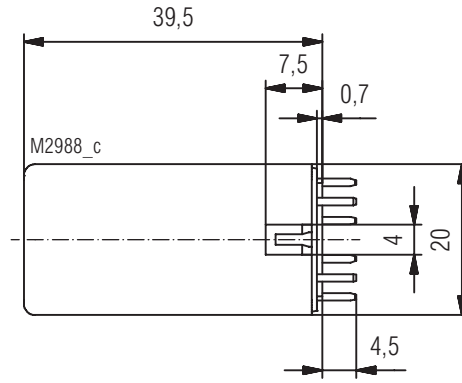
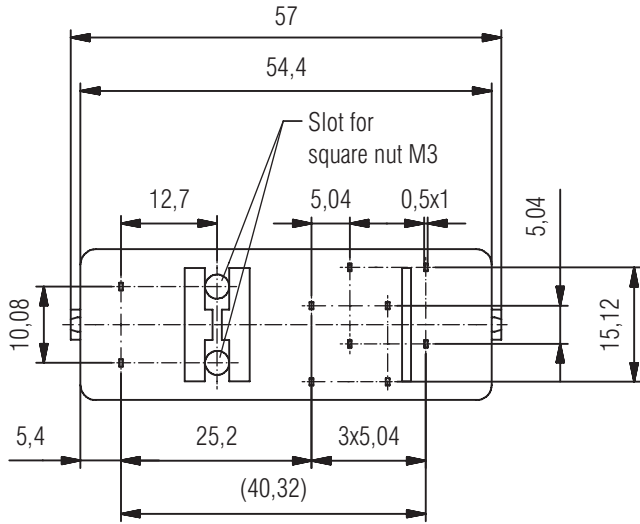

Drilling plan (solder side)

Pin arrangement OA5601.48 3NO/1NC

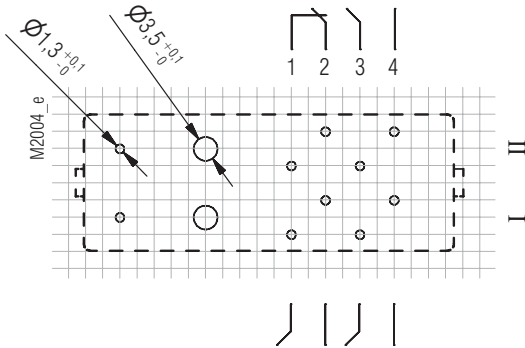

Pin arrangement OA5601.52 2NO/2NC

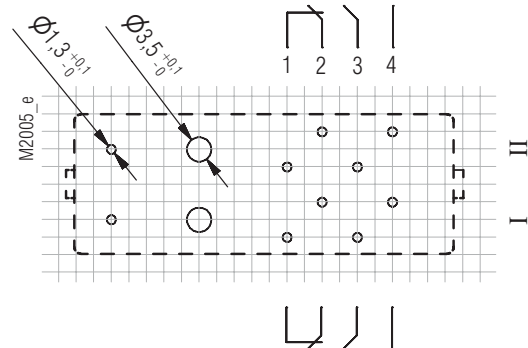

Connection for basic grid dimensions 2.5 mm as well as 2.54 mm according to IEC/EN 60097 and IEC 60326 average

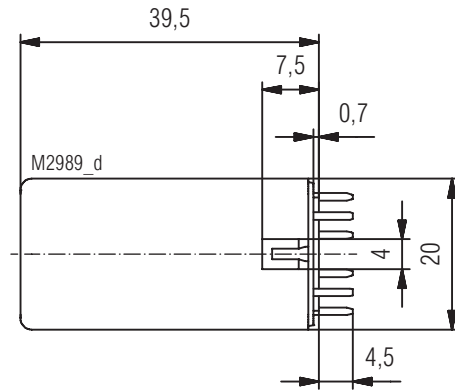
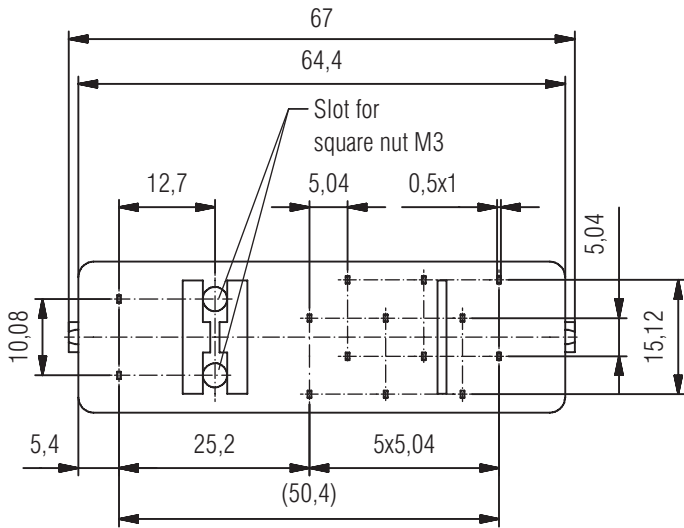

Drilling plan (solder side)

Pin arrangement OA5602.18 3NO/3NC

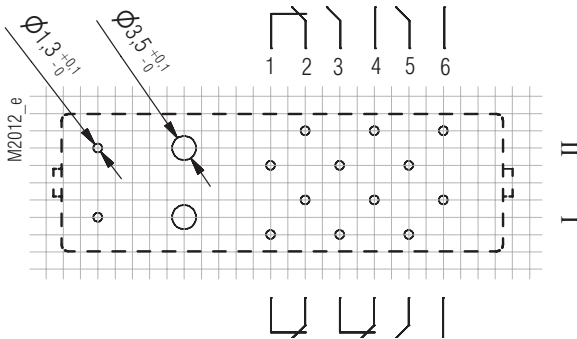

Pin arrangement OA5602.50 2NO/4NC

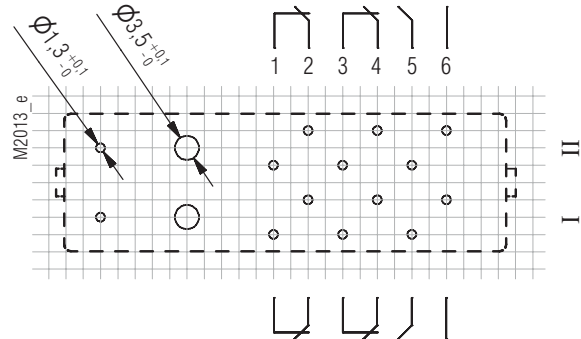

Pin arrangement OA5602.54 4NO/2NC

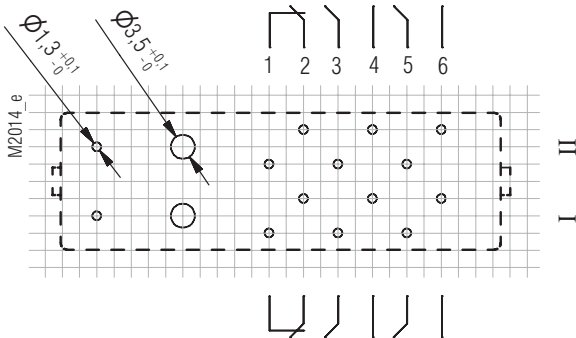

Pin arrangement OA5602.60 5NO/1NC

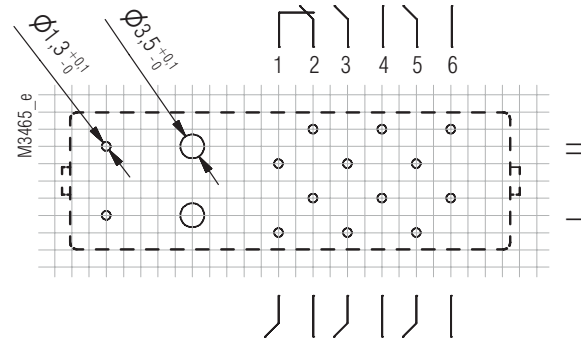

Connection for basic grid dimensions 2.5 mm as well as 2.54 mm according to IEC/EN 60097 and IEC 60326 average



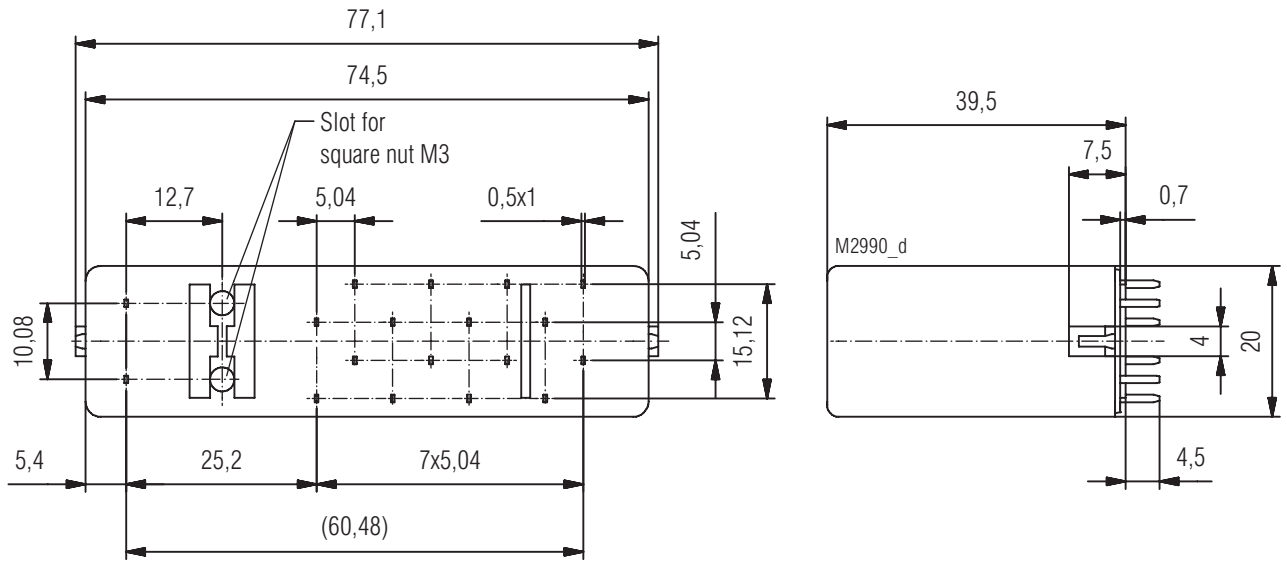

Drilling plan (solder side)

Pin arrangement OA5603.63 7NO/1NC

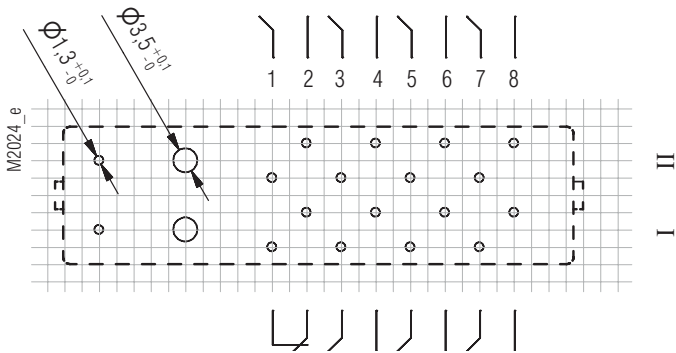

Pin arrangement OA5603.59 6NO/2NC

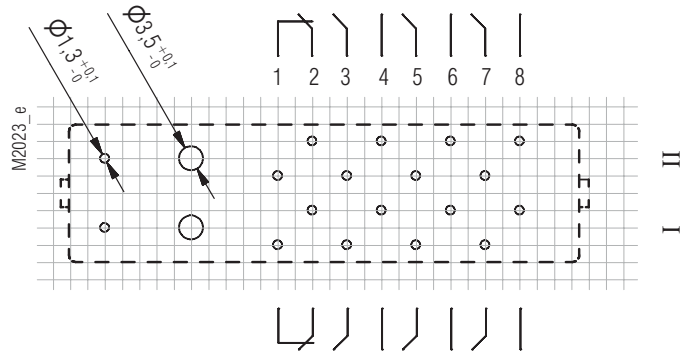

Pin arrangement OA5603.58 5NO/3NC

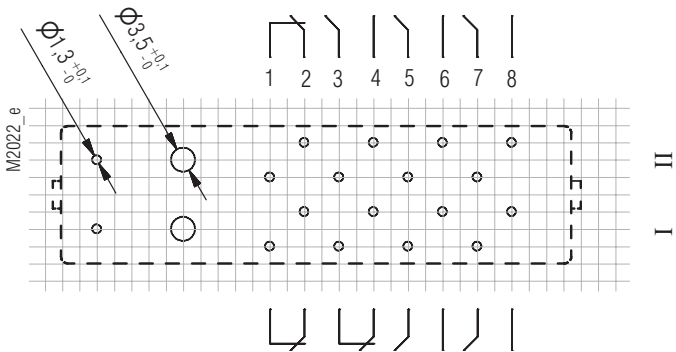

Pin arrangement OA5603.57 4NO/4NC

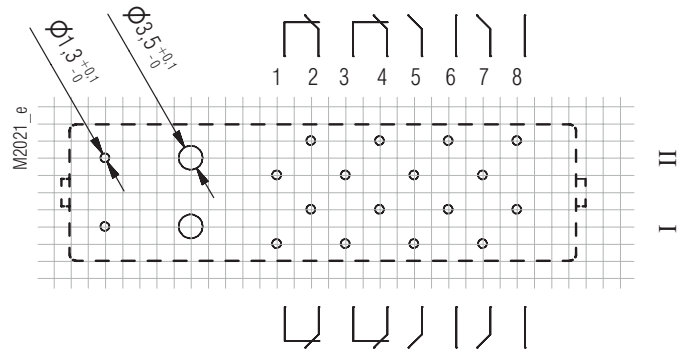

Connection for basic grid dimensions 2.5 mm as well as 2.54 mm according to IEC/EN 60097 and IEC 60326 average

Drilling plan (solder side)

Pin arrangement OA5603.56 3NO/5NC

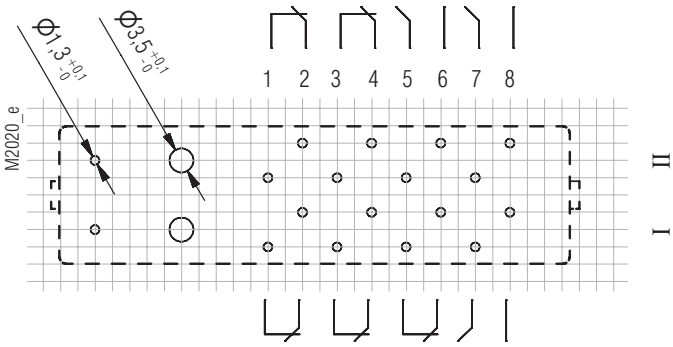

Pin arrangement OA5603.46 2NO/6NC

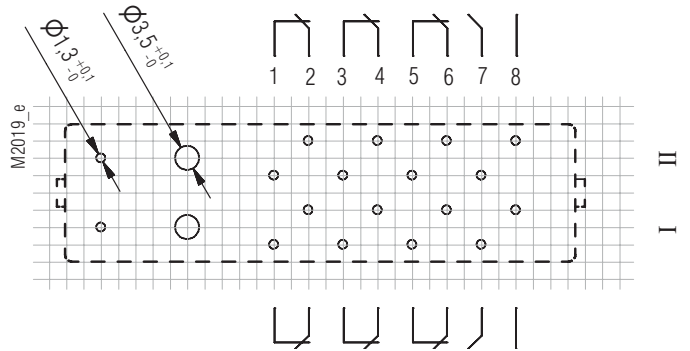

Connection for basic grid dimensions 2.5 mm as well as 2.54 mm according to IEC/EN 60097 and IEC 60326 average

Notes

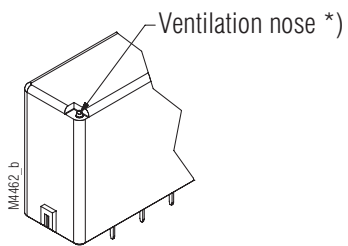

\*) When using the maximum switching capacity it is recommended to open the wash proof relay at the indicated position.

Socket ET 1415.011

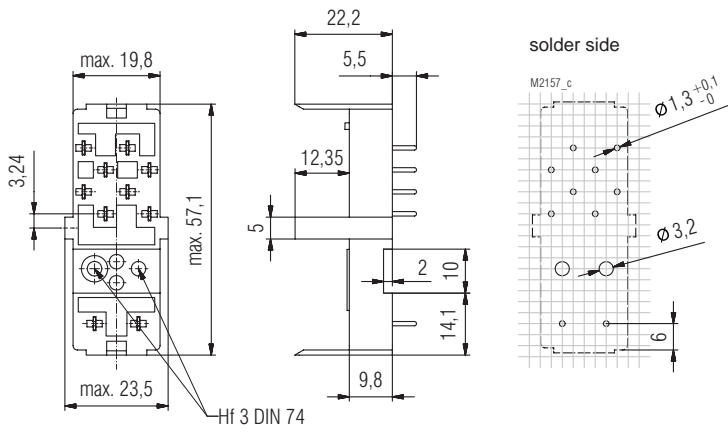

Article number: 0041069

Socket ET 1415.012

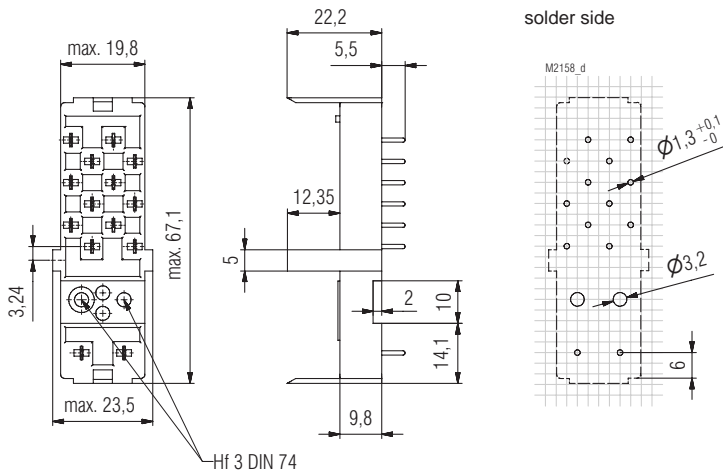

Article number: 0041065

Socket ET 1415.013

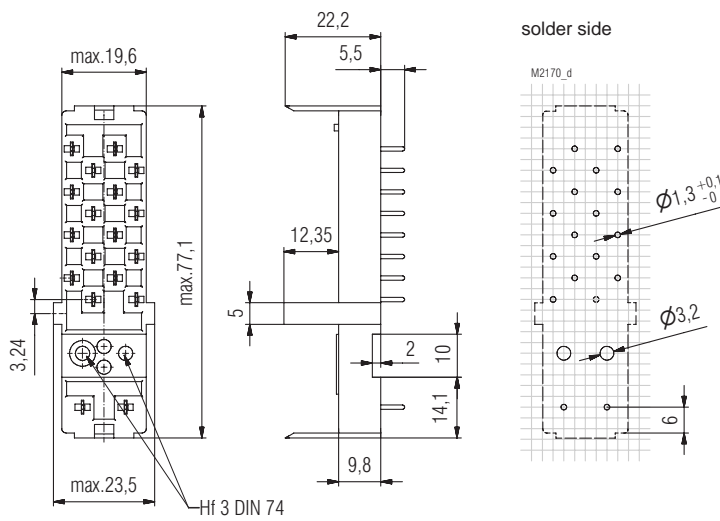

Article number: 0041070

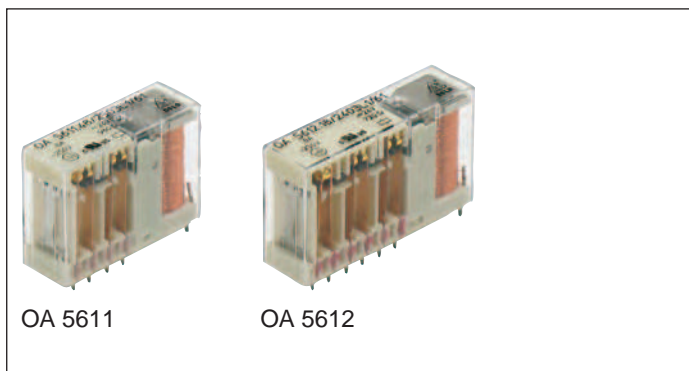

- According to DIN EN 61810-1, DIN EN 61810-3
- With forcibly guided contacts
- High switching reliability due to crown contacts
- Low rated power consumption
- High mechanical service life
- Compact size
- Optionally wash proof

### Applications

- To be used in circuits for safety applications
- Escalators and walkways
- Elevators for men and load
- Railway technology

### Approvals and Markings

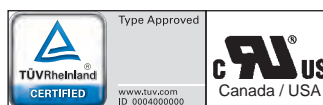

### Technical Data

Relay type		OA 5611	OA 5612
<b>1.0 Relay coil</b>			
1.1 Nominal voltage	DC V	6, 12, 24, 48, 60, 110 (others on request)	
1.2 Nominal consumption	W	0.6	0.8 / 1.0 <sup>3)</sup>
1.11 Voltage range	U <sub>N</sub>	0.7 ... 1.4	
1.13 Holding power (at 0.5 x U <sub>N</sub> )	W	0.15	0.20 / 0.24 <sup>3)</sup>
<b>2.0 Contacts</b>			
2.1 Contact arrangement		2 NO / 2 NC 3 NO / 1 NC	2 NO / 4 NC 3 NO / 3 NC 4 NO / 2 NC 5 NO / 1 NC
2.2 Contact material		AgSnO <sub>2</sub> + 0.2 µm Au; AgNi + 0.2 µm Au, AgNi + 5 µm Au	
2.3 Rated insulation voltage	AC V	250	
Switching voltage min./max	V	AC/DC 10 / DC 250, AC 400 (AC/DC 2 V / 60 V) <sup>1)</sup>	
2.4 Limit. contin. current I <sub>b</sub> max.	A	3 e.g. 5 x 8 (see operating voltage limit curve)	
Switching current min./max	A	> 10 mA <sup>4)</sup> / 8 (2 mA / 0.3 A) <sup>1)</sup>	
2.5 Switching power min./max.	VA	0.1 / 2000 (10 mVA / 12 VA) <sup>1)</sup>	
Switching power min./max	W	0.1 <sup>4)</sup> / 200 (10 mW / 12 W) <sup>1)</sup> (see limit curve for arc-free operation)	
2.6 Switching capacity IEC/EN 60947-5-1			
AC 15 <sup>5)</sup>	AC V/A	NO: 250 / 2	NC: 250 / 1
AC 15 <sup>6)</sup>	AC V/A	NO: 250 / 3	NC: 250 / 2
DC 13 <sup>5)</sup>	DC V/A	NO: 24 / 1	NC: 24 / 1
DC 13 <sup>5)</sup> at 0.1 Hz to UL 508	DC V/A	NO: 24 / 4	NC: 24 / 4
		B300	
2.7 Electrical life		at 1 s ON, 1 s OFF (see contacts service life)	
at AC 230 V, 5 A, cosφ = 1	switching cycles	> 3 x 10 <sup>5</sup> AgSnO <sub>2</sub>	> 2 x 10 <sup>5</sup> AgNi 10
at AC 230 V, 8 A, cosφ = 1	switching cycles	> 1.5 x 10 <sup>5</sup> AgSnO <sub>2</sub>	> 10 <sup>5</sup> AgNi 10
2.8 Switching frequency max.	switching cycles / s	10	
2.9 Response time / Release time	ms	typically 20 / typically 6	
2.10 Contact force	cN	≥ 10	
2.14 Contact gap	mm	> 1 (normal operation) / > 0.5 <sup>2)</sup> (under fault)	
<b>3.0 Other</b>			
3.1 Mechanical life	switching cycles	≥ 50 x 10 <sup>6</sup>	
3.2 Temperature range	°C	- 40 ... + 85	- 40 ... + 85
3.3 Degree of protection		Solder line proof RT II as option wash proof RT III	
3.4 Test procedure		A (group mounting)	
3.5 Vibration resistance		10 ... 200 Hz; 0.35 mm amplitude; 3 g max. IEC/EN 60068-2-6	
3.6 Climate resistance		40 / 085 / 04; A / B / D IEC/EN 60068-1	
3.7 Short circuit strength 1 kA / AC 250 V	AgSnO <sub>2</sub> AgNi	NO: 10 A gL / NC: 10 A gL NO: 10 A gL / NC: 6 A gL	IEC/EN 60947-5-1 IEC/EN 60947-5-1

<sup>1)</sup> Values for AgNi 10-Contacts + 5 µm Au

<sup>3)</sup> OA 5612.50 (2 NO / 4 NC)

<sup>5)</sup> Values for AgNi-Contacts

<sup>2)</sup> over entire service life, even when under fault and at 1.4 x U<sub>N</sub>

<sup>4)</sup> Typical values for AgSnO<sub>2</sub> and AgNi

<sup>6)</sup> Values for AgSnO<sub>2</sub>-Contacts

## Technical Data

3.8	Insulation acc. to IEC 60664-1, EN 50178			
	Rated insulation voltage	AC V	250	
	Pollution degree		3	
	Overvoltage category		III	
	Test voltage			
	Contact - Coil (1 min)	AC kV eff.	≥ 4	
	Contact - Contact (1min)	AC kV eff.	≥ 2.5	
	Open contact acc. to DIN EN 61810-1	AC kV eff.	1.5	
	Transient voltage			
	Contact - Coil (1,2 - 50 μs)	kV	≥ 6	
	Clearance and creepage distances			
	Contact - Coil	mm	≥ 8	
	Contact side-Contact side	mm	≥ 4.5	
	Contact - Contact	mm	≥ 4.5	
3.9	Weight	g	approx. 35	approx. 38
<b>4.0 Packing</b>				
4.1	on cardboard	piece	30	20
4.2	in case package	piece	150	100
<b>5.0 Solder method</b>				
5.1	Solder method /-temperature /-duration	°C / s	Wafer soldering / 260 / 5	

## Design versions

U <sub>N</sub> (DC V)	Voltage range (DC V)	OA 5611			OA 5612					
		R <sub>Coil</sub> Ω ± 10%	.48 3NO, 1NC	.52 2NO, 2NC	R <sub>Coil</sub> Ω ± 10%	.18 3NO, 3NC	.54 4NO, 2NC	.60 5NO, 1NC	R <sub>Coil</sub> Ω ± 10%	.50 2NO, 4NC
AgSnO-contacts + 0,2 μm Au										
6	4,2 ... 8,4	56	2491	2521	45	2401	2461	2571	36	2431
12	8,4 ... 16,8	240	2492	2522	180	2402	2462	2572	145	2432
24	16,8 ... 33,6	960	2493	2523	720	2403	2463	2573	600	2433
48	33,6 ... 67,2	3840	2494	2524	2880	2404	2464	2574	2300	2434
60	42,0 ... 84,0	6000	2495	2525	4500	2405	2465	2575	3600	2435
110	77,0 ... 154,0	20150	2496	2526	15125	2406	2466	2576	12100	2436
AgNi-contacts + 0,2 μm Au										
6	4,2 ... 8,4	56	2501	2531	45	2411	2471	2581	36	2441
12	8,4 ... 16,8	240	2502	2532	180	2412	2472	2582	145	2442
24	16,8 ... 33,6	960	2503	2533	720	2413	2473	2583	600	2443
48	33,6 ... 67,2	3840	2504	2534	2880	2414	2474	2584	2300	2444
60	42,0 ... 84,0	6000	2505	2535	4500	2415	2475	2585	3600	2445
110	77,0 ... 154,0	20150	2506	2536	15125	2416	2476	2586	12100	2446
AgNi-contacts + 5 μm Au										
6	4,2 ... 8,4	56	2511	2541	45	2421	2481	2591	36	2451
12	8,4 ... 16,8	240	2512	2542	180	2422	2482	2592	145	2452
24	16,8 ... 33,6	960	2513	2543	720	2423	2483	2593	600	2453
48	33,6 ... 67,2	3840	2514	2544	2880	2424	2484	2594	2300	2454
60	42,0 ... 84,0	6000	2515	2545	4500	2425	2485	2595	3600	2455
110	77,0 ... 154,0	20150	2516	2546	15125	2426	2486	2596	12100	2456

## Ordering example

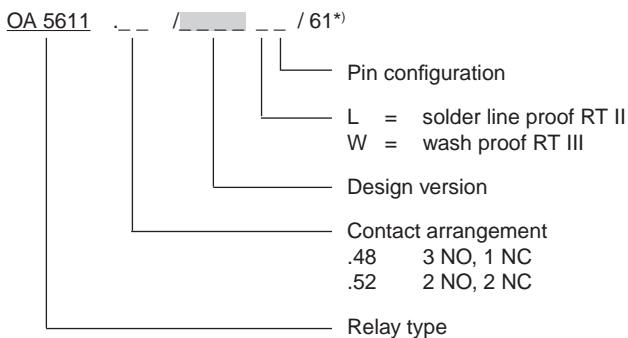

\*) / 61 cURus approval

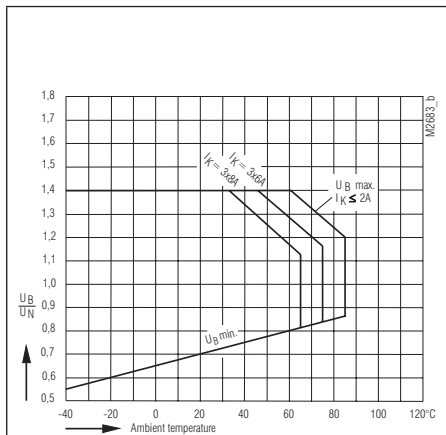

Operating voltage limit curve OA 5611

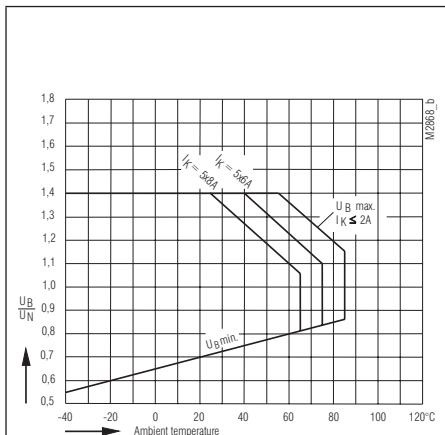

Operating voltage limit curve OA 5612

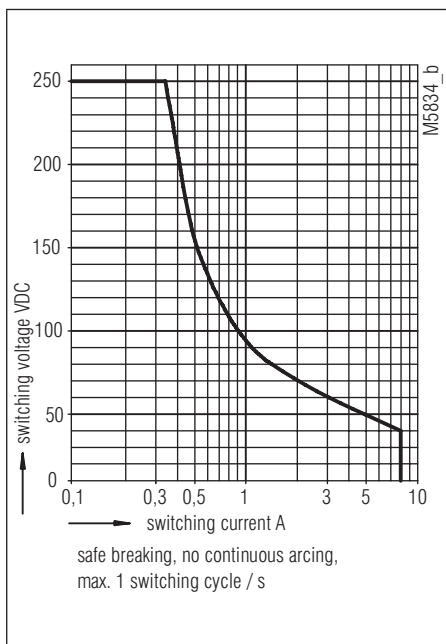
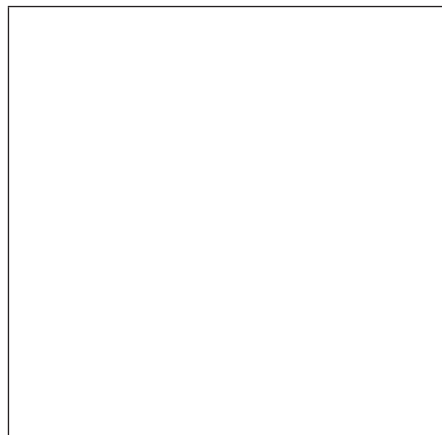

Limit curve for arc-free operation (load limit curve)

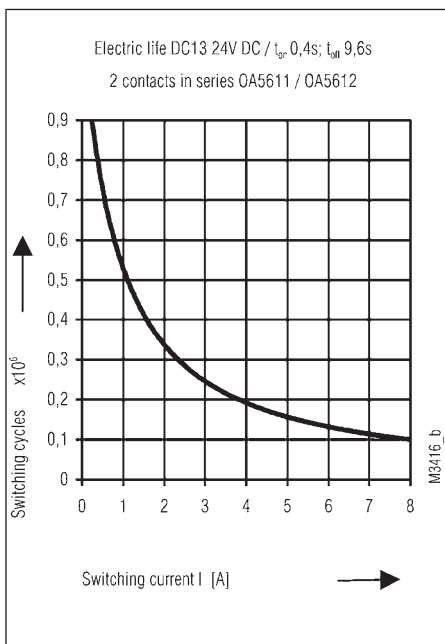

Electric life

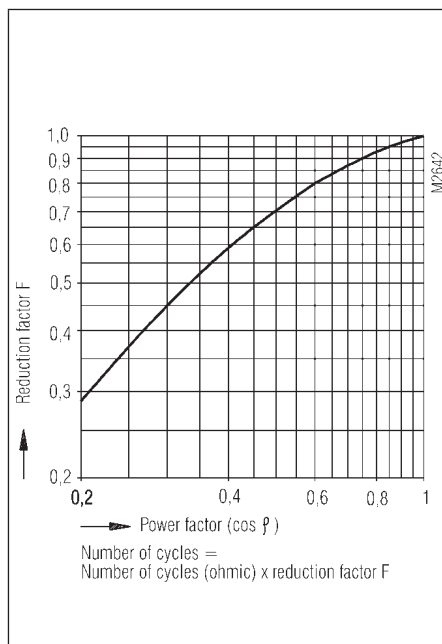

Reduction factor for inductive loads

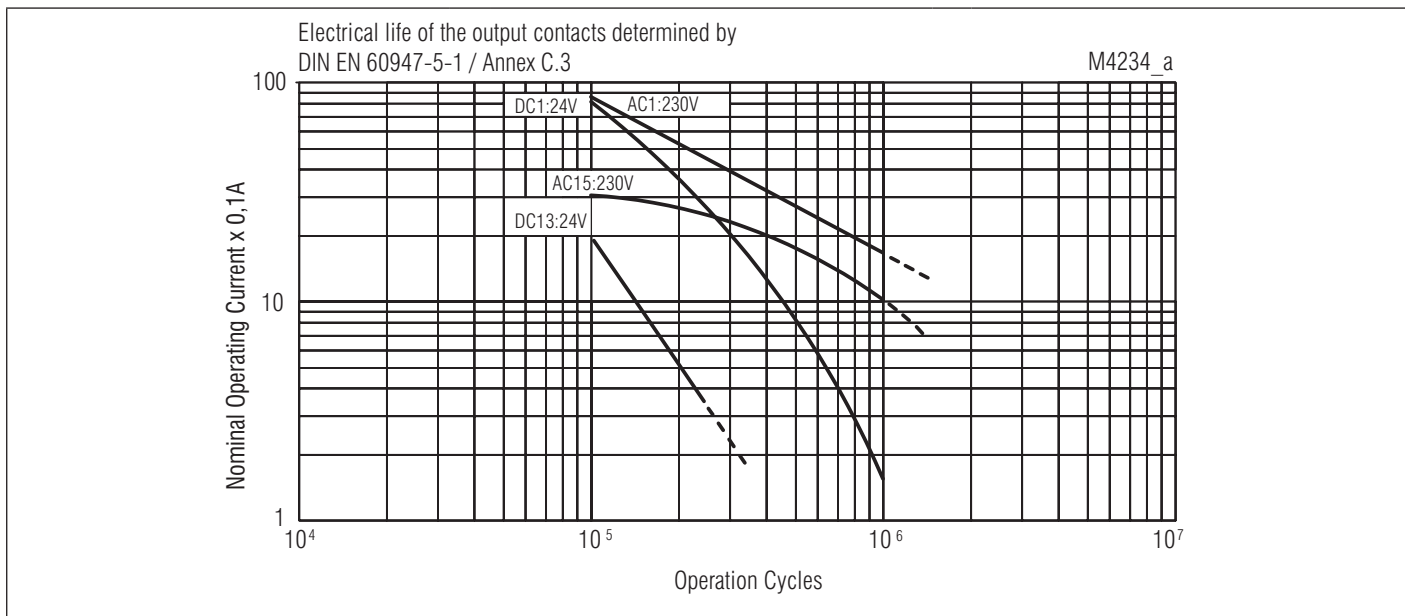

Electrical life for contact material AgNi

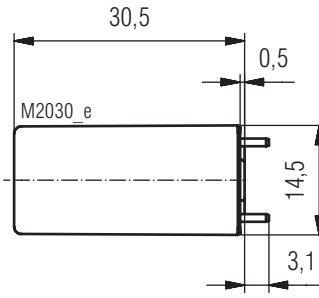
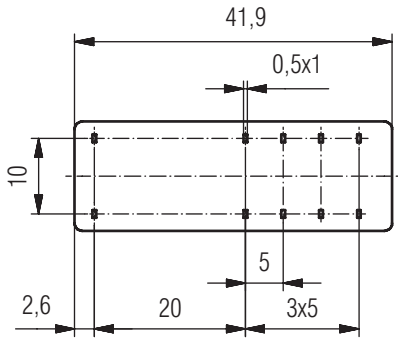

Drilling plan (solder side)

Pin arrangements OA 5611.52/...L1 2NO / 2NC

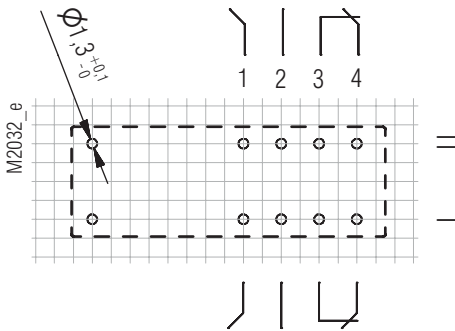

Pin arrangements OA 5611.52/...L4 2NO / 2NC

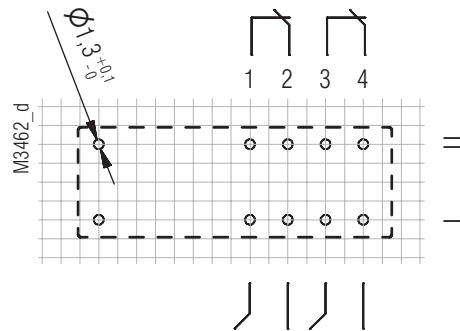

Pin arrangements OA 5611.52/...L5 2NO / 2NC

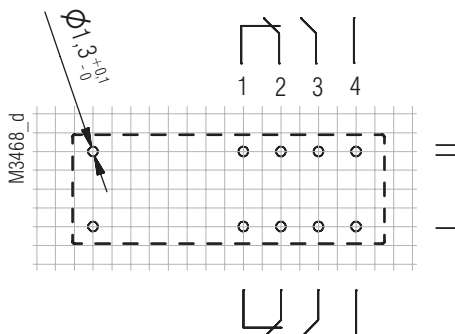

Pin arrangements OA 5611.48/...L1 3NO / 1NC

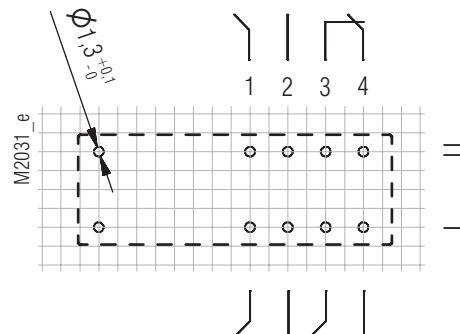

Pin arrangements OA 5611.48/...L4 3NO / 1NC

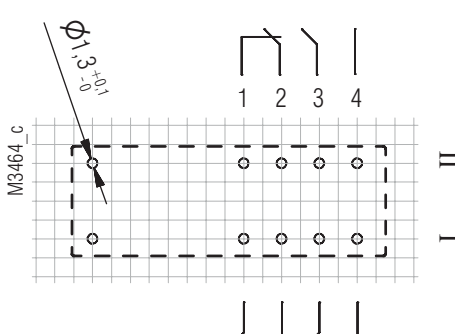

Pin arrangements OA 5611.28 1NO / 3NC

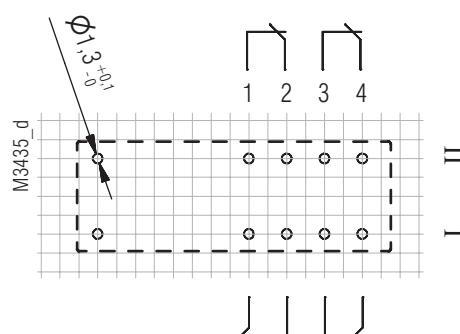

Connection for basic grid dimensions 2.5 mm as well as 2.54 mm according to IEC/EN 60097 and IEC 60326 average

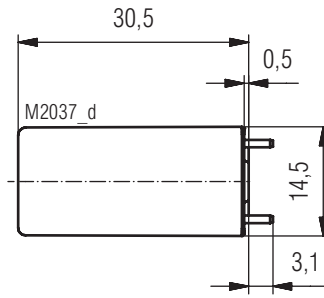
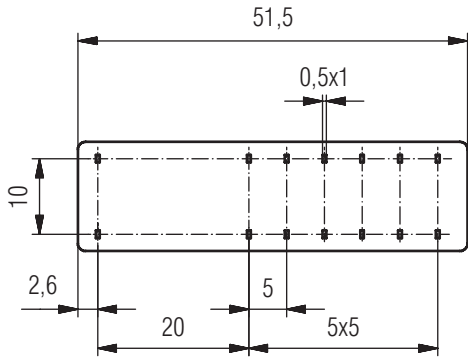

Drilling plan (solder side)

Pin arrangements OA 5612.60/...L4 5NO / 1NC

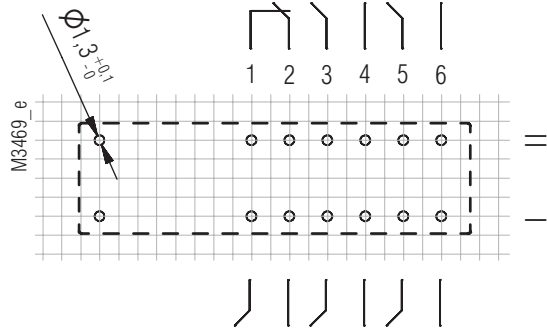

Drilling plan (solder side)

Pin arrangements OA 5612.60/...L1 5NO / 1NC

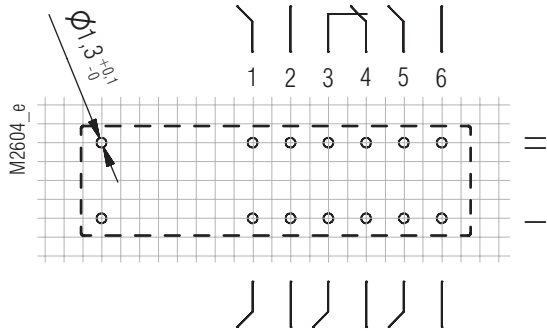

Pin arrangements OA 5612.54/...L4 4NO / 2NC

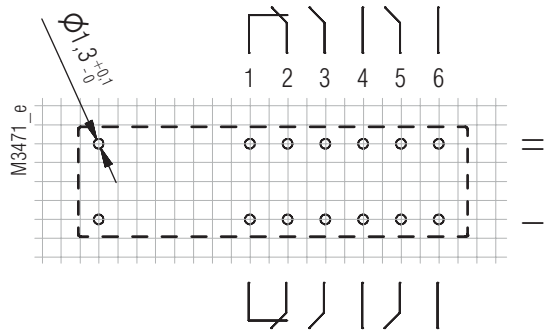

Pin arrangements OA 5612.54/...L1 4NO / 2NC

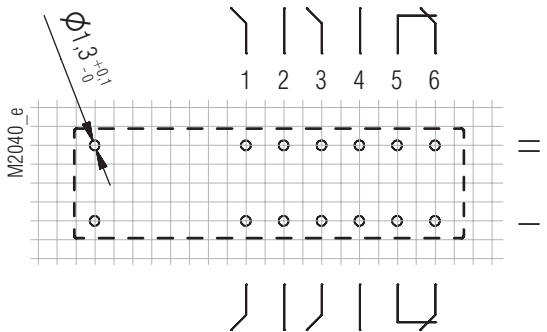

Pin arrangements OA 5612.50/...L4 2NO / 4NC

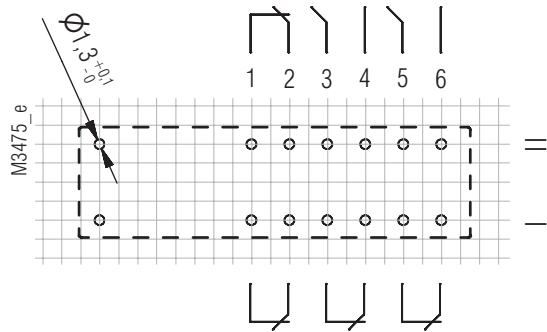

Pin arrangements OA 5612.50/...L1 2NO / 4NC

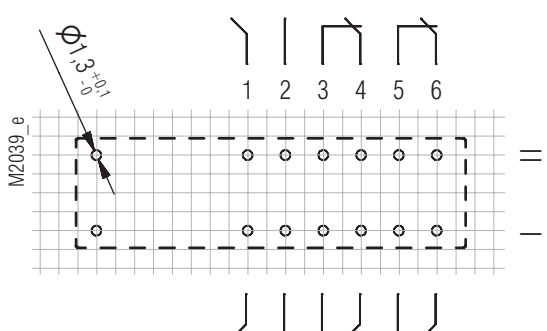

Pin arrangements OA 5612.18/...L1 3NO / 3NC

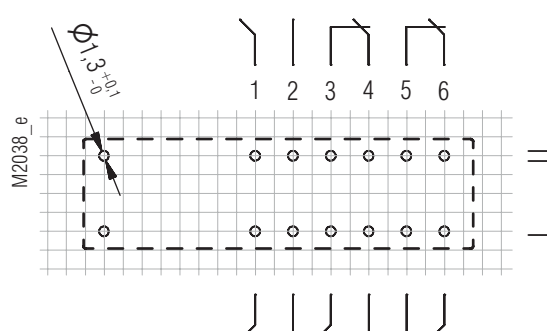

Connection for basic grid dimensions 2.5 mm as well as 2.54 mm according to IEC/EN 60097 and IEC 60326 average



Socket ET 1415.031

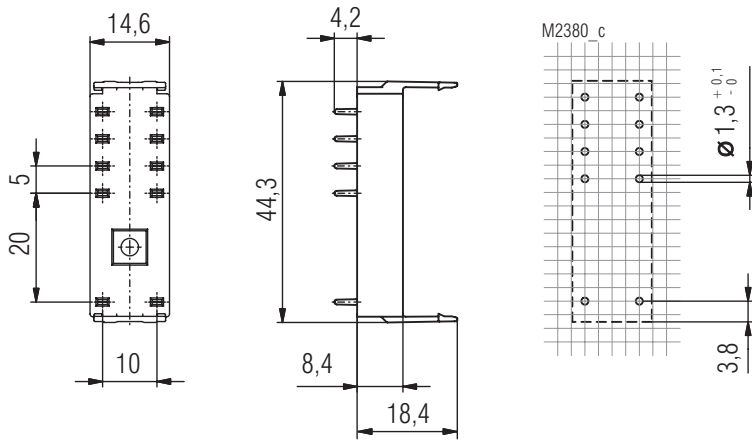

Article number: 0049512

Socket ET 1415.032

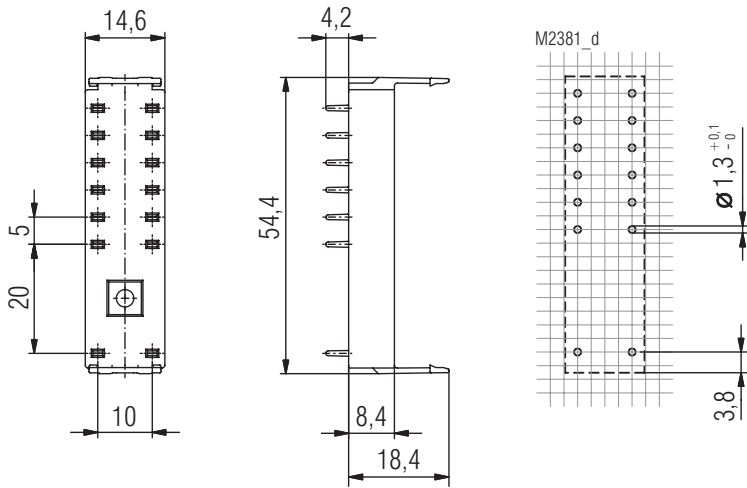

Article number: 0049513

## Safety relays, sensitive

OA 5611.\_ \_ / \_ \_ \_ \_ S \_ ; OA 5612.\_ \_ / \_ \_ \_ \_ S \_

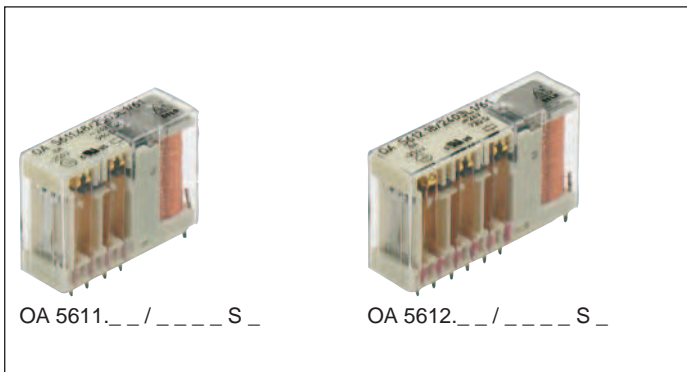

OA 5611.\_ \_ / \_ \_ \_ \_ S \_

OA 5612.\_ \_ / \_ \_ \_ \_ S \_

- According to DIN EN 61810-1, DIN EN 61810-3
- With forcibly guided contacts
- High switching reliability due to crown contacts
- Very low rated power consumption  
OA 5611: 0.36 W with 4 contacts  
OA 5612: 0.5 W with 6 contacts
- High mechanical service life
- Compact size

### Applications

- To be used in electrical circuits for safety applications.
- Escalators and walkways
- Elevators for men and load
- Railway technology

### Approvals and Markings

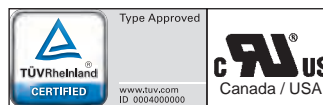

### Technical Data

Relay type		OA 5611._ _ / _ _ _ _ S _	OA 5612._ _ / _ _ _ _ S _
<b>1.0 Relay coil</b>			
1.1 Nominal voltage	DC V	6, 12, 24, 48, 60, 110 (others on request) polarised	
1.2 Nominal consumption	W	0.36	0.5 / 0.8 <sup>3)</sup>
1.11 Voltage range	U <sub>N</sub>	0.75 ... 1.8	
1.13 Holding power (at 0,5 U <sub>N</sub> )	W	0.1	0.13 / 0.2 <sup>3)</sup>
<b>2.0 Contacts</b>			
2.1 Contact arrangement		2 NO / 2 NC 3 NO / 1 NC	2 NO / 4 NC 3 NO / 3 NC 4 NO / 2 NC 5 NO / 1 NC
2.2 Contact material		AgSnO <sub>2</sub> + 0.2 µm Au; AgNi + 0.2 µm Au, AgNi + 5 µm Au	
2.3 Rated insulation voltage	AC V	250	
Switching voltage min./max	V	AC/DC 10 / DC 250, AC 400 (AC/DC 2 V / 60 V) <sup>1)</sup>	
2.4 Limit. contin. current I <sub>b</sub> max.	A	3 e.g. 5 x 6 (see operating voltage limit curve)	
Switching current min./max	A	> 10 mA <sup>4)</sup> / 6 (2 mA / 0.3 A) <sup>1)</sup>	
2.5 Switching power min./max.	VA	0.1 / 1500 (10 mVA / 12 VA) <sup>1)</sup>	
Switching power min./max	W	0.1 <sup>4)</sup> / 200 (10 mW / 12 W) <sup>1)</sup> (see limit curve for arc-free operation)	
2.6 Switching capacity to IEC/EN 60947-5-1			
AC 15 <sup>5)</sup>	AC V/A	NO: 250 / 2	NC: 250 / 1
AC 15 <sup>6)</sup>	AC V/A	NO: 250 / 3	NC: 250 / 2
DC 13 <sup>5)</sup>	DC V/A	NO: 24 / 1	NC: 24 / 1
DC 13 <sup>5)</sup> at 0.1 Hz	DC V/A	NO: 24 / 4	NC: 24 / 4
to UL 508		B300	
2.7 Electrical life		at 1 s On, 1 s Off (see contact service life)	
at AC 230 V, 6 A, cosφ = 1	switching cycles	> 3 x 10 <sup>5</sup> AgSnO <sub>2</sub>	> 2 x 10 <sup>5</sup> AgNi 10
2.8 Switching frequency max.	switching cycles/s	10	
2.9 Response time / Release time	ms	typically 20 / typically 6	
2.10 Contact force	cN	≥ 8	
2.14 Contact gap	mm	> 1 (normal operation) / > 0.5 <sup>2)</sup> (under fault)	
<b>3.0 Other</b>			
3.1 Mechanical life	switching cycles	≥ 50 x 10 <sup>6</sup>	
3.2 Temperature range	°C	- 40 ... + 85	- 40 ... + 85
3.3 Degree of protection		Solder line proof RT II	
3.4 Test procedure		A (group mounting)	
3.5 Vibration resistance		10 ... 200 Hz; 0.35 mm amplitude; 3 g max. IEC/EN 60068-2-6	
3.6 Climate resistance		40 / 085 / 04; A / B / D IEC/EN 60068-1	
3.7 Short circuit strength 1 kA / AC 250 V	AgSnO <sub>2</sub>	NO: 10 A gL / NC: 10 A gL	IEC/EN 60947-5-1
	AgNi	NO: 10 A gL / NC: 6 A gL	IEC/EN 60947-5-1

<sup>1)</sup> Values for AgNi10-contacts + 5 µm Au

<sup>3)</sup> OA 5612.50 (2 NO contacts / 4 NC contacts)

<sup>5)</sup> Values for AgNi-Contacts

<sup>2)</sup> over entire service life, even under fault and at 1.5 x U<sub>N</sub>

<sup>4)</sup> Typical values for AgSnO<sub>2</sub> and AgNi

<sup>6)</sup> Values for AgSnO<sub>2</sub>-Contacts

## Technical Data

3.8	Insulation acc. to IEC 60664-1, EN 50178		
	Rated insulation voltage	AC V	250
	Pollution degree		3
	Overvoltage category		III
	Test voltage		
	Contact - Coil (1 min)	AC kV eff.	≥ 4
	Contact - Contact (1min)	AC kV eff.	≥ 2.5
	Open contact acc. to DIN EN 61810-1	AC kV eff.	1.5
	Transient voltage		
	Contact - Coil (1,2 - 50 µs)	kV	≥ 6
	Clearance and creepage distances		
	Contact - Coil	mm	≥ 8
	Contact side-Contact side	mm	≥ 4.5
	Contact - Contact	mm	≥ 4.5
3.9	Weight	g	approx. 35
			approx. 38
<b>4.0 Packing</b>			
4.1	on cardboard	piece	30
			20
4.2	in case package	piece	150
			100
<b>5.0 Solder method</b>			
5.1	Solder method /-temperature /-duration	°C / s	Wafer soldering / 260 / 5

## Design Versions

OA 5611					OA 5612							
U <sub>N</sub> (DC V)	Voltage range (DC V)	R <sub>Coil</sub> at 20 °C Ω	.48	.52	U <sub>N</sub> (DC V)	Voltage range (DC V)	R <sub>Coil</sub> at 20 °C Ω	.18	.54	.60	R <sub>Coil</sub> at 20 °C Ω	.50
			3S / 1Ö	2S / 2Ö				3S / 3Ö	4S / 2Ö	5S / 1Ö		2S / 4Ö
6	4,5 ... 9,0	100			6	4,5 ... 9,0	70				45	
12	9,0 ... 18,0	400			12	9,0 ... 18,0	290				180	
24	18,0 ... 36,0	1600			24	18,0 ... 36,0	1150				720	
48	36,0 ... 72,0	6400	on request		48	36,0 ... 72,0	4600	on request			2880	on request
60	45,0 ... 90,0	10000			60	45,0 ... 90,0	7200				4500	
110	82,5 ... 165,0	33600			110	82,5 ... 165,0	24200				15125	

## Ordering example

OA 5611 \_ \_ \_ / \_ \_ \_ S \_ / 61\*)

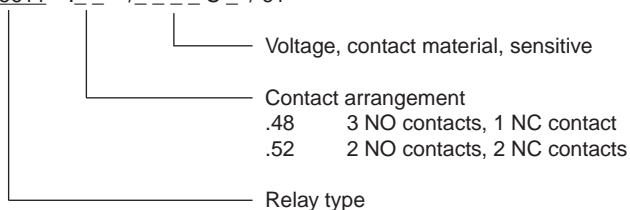

\*) / 61 cURus approval

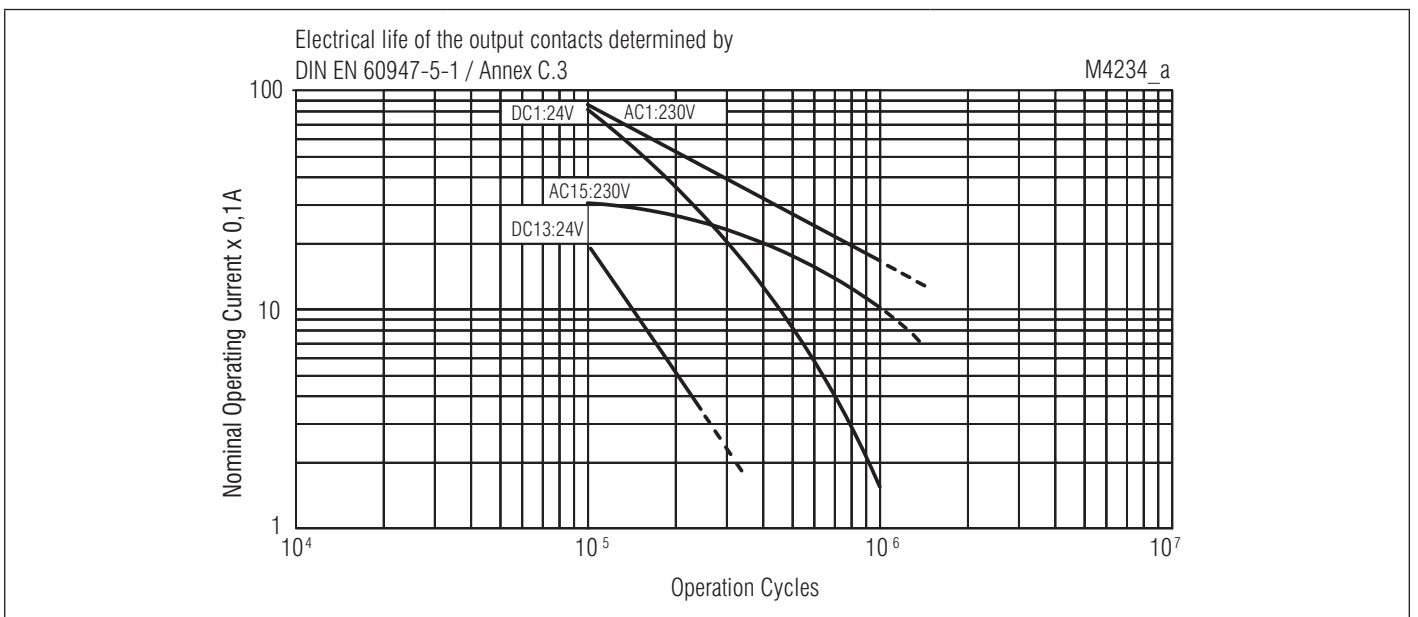
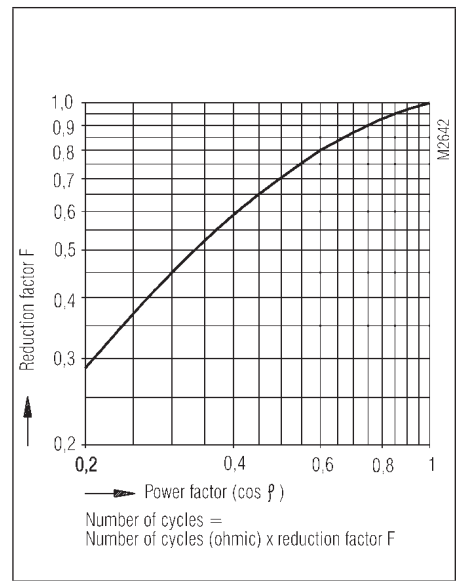
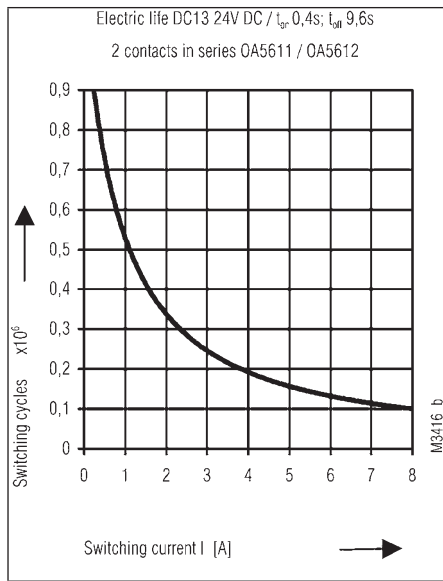
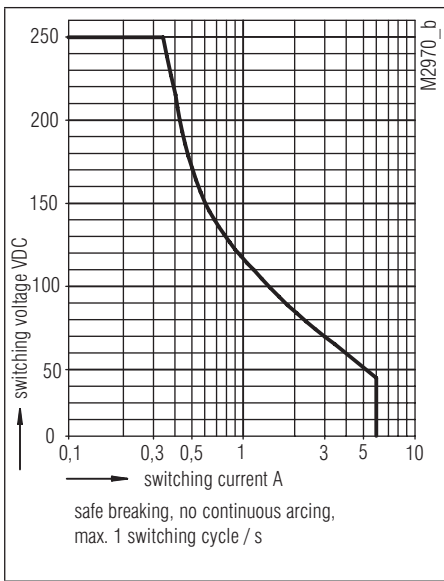
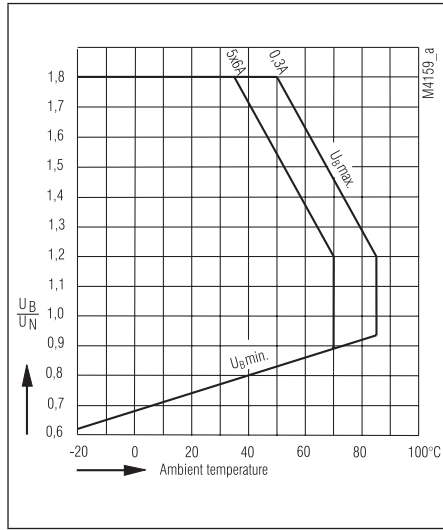
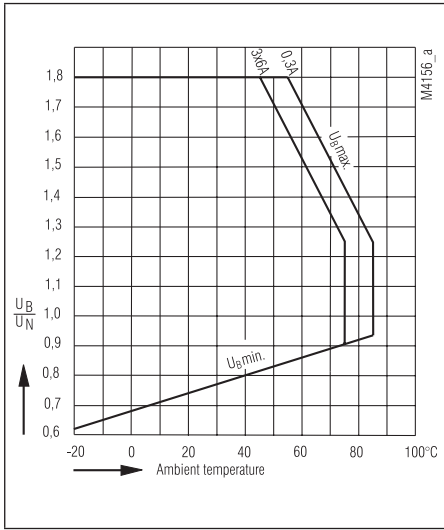

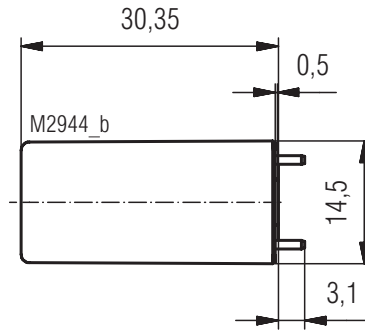
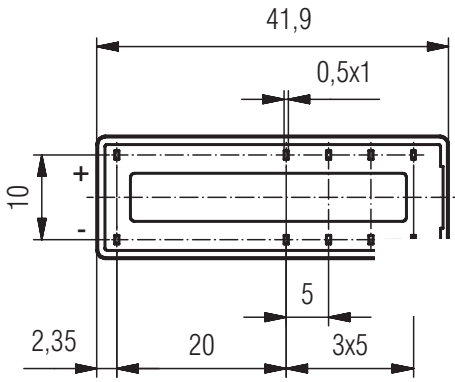

Drilling plan (solder side)

Pin arrangement OA 5611.52/...S1 2NO / 2NC

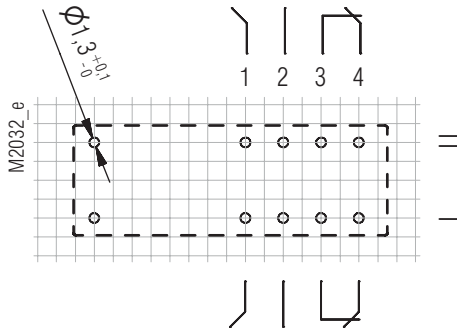

Pin arrangement OA 5611.52/...S4 2NO / 2NC

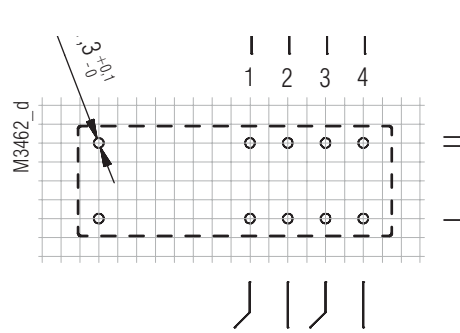

Pin arrangement OA 5611.52/...S5 2NO / 2NC

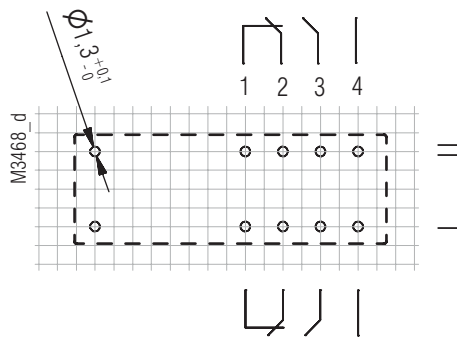

Pin arrangement OA 5611.48/...S1 3NO / 1NC

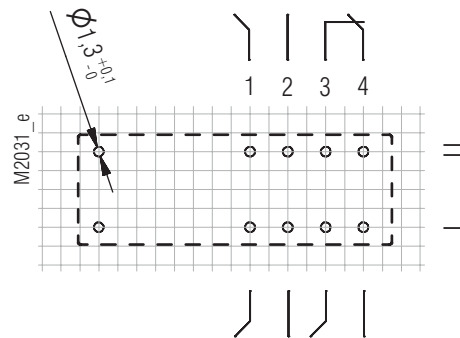

Pin arrangement OA 5611.48/...S4 3NO / 1NC

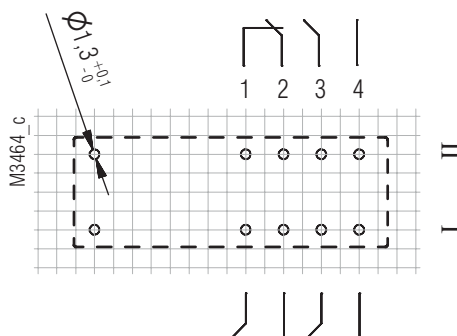

Pin arrangement OA 5611.28 1NO / 3NC

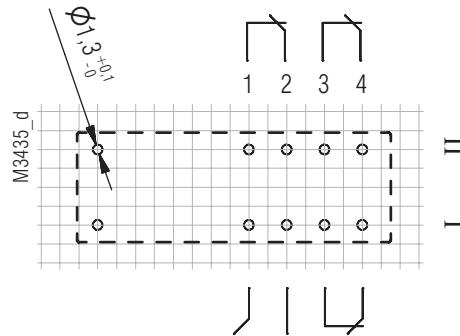

Connection for basic grid dimensions 2.5 mm as well as 2.54 mm according to IEC/EN 60097 and IEC 60326 average

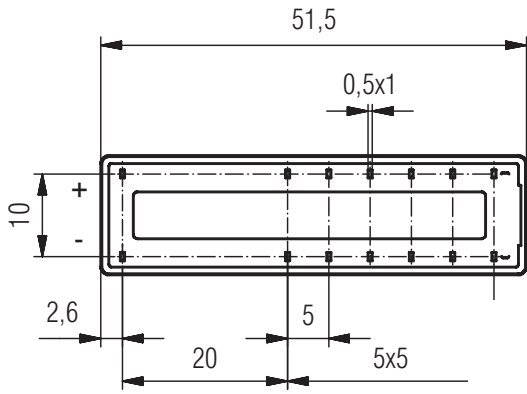

Drilling plan (solder side)

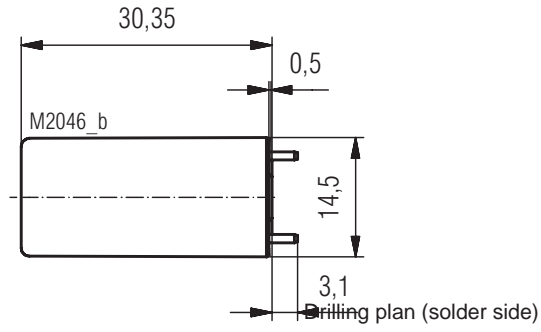

Pin arrangement OA 5612.60/...S4 5NO / 1NC

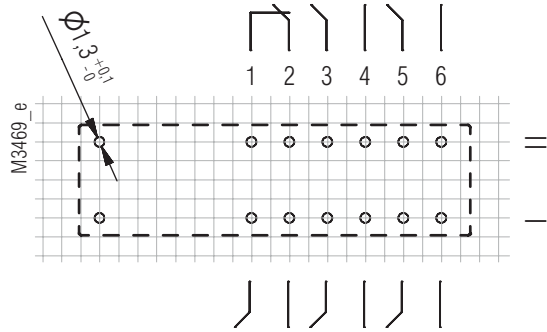

Pin arrangement OA 5612.54/...S4 4NO / 2NC

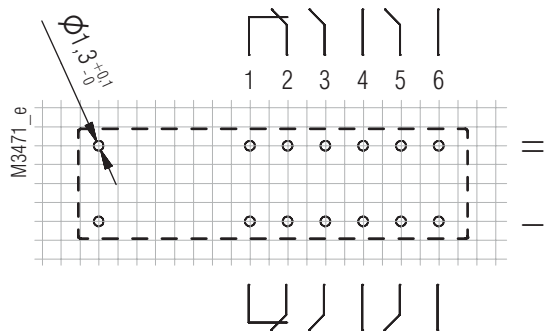

Pin arrangement OA 5612.50/...S4 2NO / 4NC

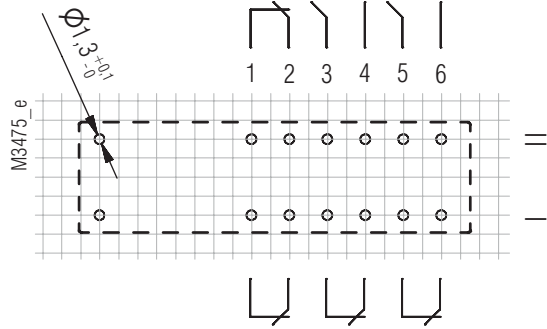

Pin arrangement OA 5612.18/...S1 3NO / 3NC

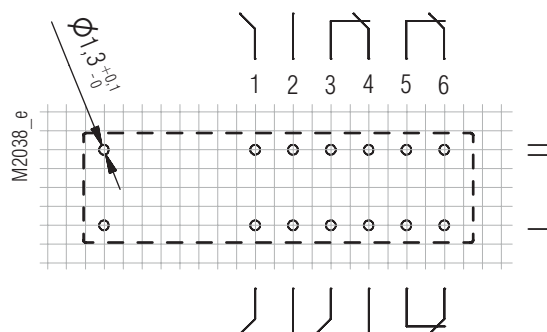

Pin arrangement OA 5612.60/...S1 5NO / 1NC

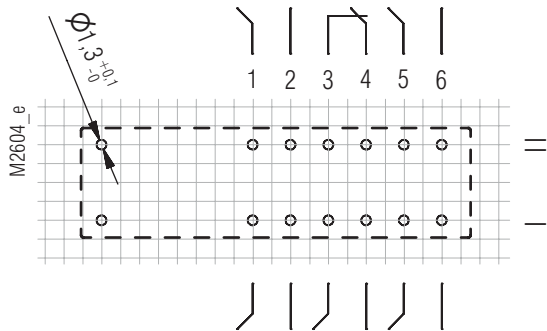

Pin arrangement OA 5612.54/...S1 4NO / 2NC

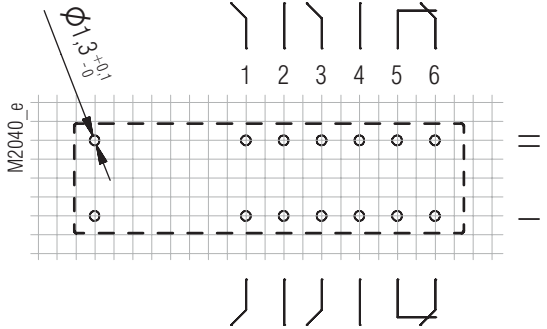

Pin arrangement OA 5612.50/...S1 2NO / 4NC

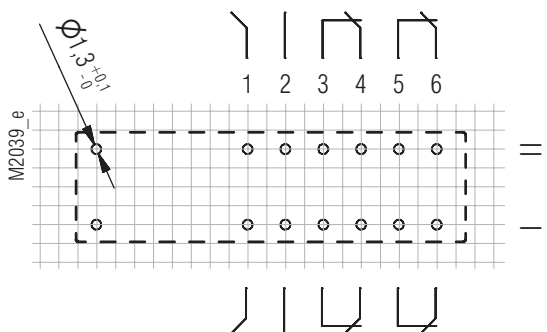

Connection for basic grid dimensions 2.5 mm as well as 2.54 mm according to IEC/EN 60097 and IEC 60326 average

Socket ET 1415.031

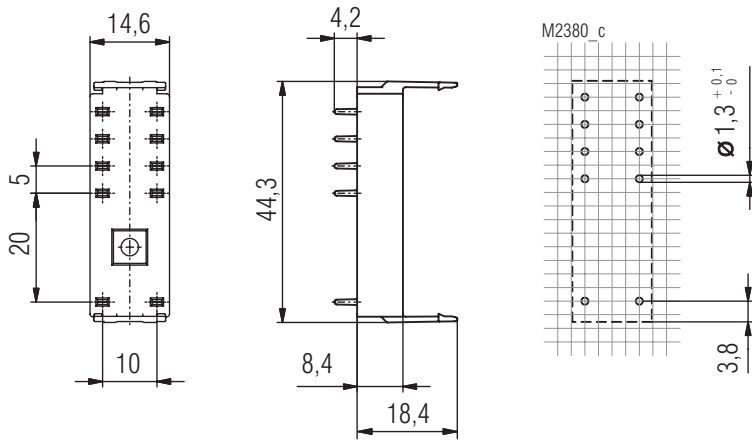

Article number: 0049512

Socket ET 1415.032

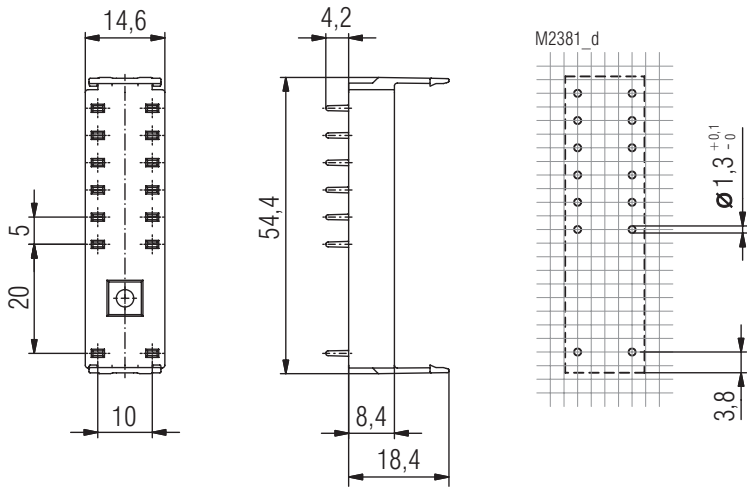

Article number: 0049513



- Acc. to DIN EN 61810-1, DIN EN 61810-3, DIN EN 50578 (UIC 736)
- With forcibly guided contacts
- High switching reliability due to crown contacts
- Low rated power consumption
- High mechanical service life
- Compact size

## Anwendungen

- To be used in electrical circuits for safety applications.
- For railway signalling circuits according to DIN EN 50578 (UIC 736 R: 2004)

## Approvals and Markings

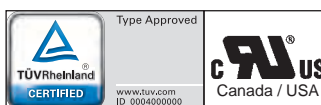

## Technical Data

Relay type		OA 5611
<b>1.0 Relay coil</b>		
1.1 Nominal voltage	DC V	6, 12, 24, 48, 60, 110 (others on request)
1.2 Nominal consumption	W	0.7
1.11 Voltage range	$U_N$	0.75 ... 1.4
1.13 Holding power (at 0.5 $U_N$ )	W	0.18
1.14 Airgap in magnetic circuit	mm	> 0.1
<b>2.0 Contacts</b>		
2.1 Contact arrangement		2 NO / 2 NC 3 NO / 1 NC
2.2 Contact material		AgSnO <sub>2</sub> + 0.2 µm Au; AgNi + 0.2 µm Au, AgNi + 5 µm Au
2.3 Rated insulation voltage	AC V	250
Switching voltage min./max.	V	AC/DC 10 / DC 250, AC 400 (AC/DC 2 V / 60 V) <sup>1)</sup>
2.4 Limiting continuous current $I_{th}$	A	3 x 8 (see operating voltage limit curve)
Switching current min./max.	A	> 10 mA <sup>3)</sup> / 8 (2 mA / 0.3 A) <sup>1)</sup>
2.5 Switching power min./max.	VA	0.1 / 2000 (10 mVA / 12 VA) <sup>1)</sup>
Switching power min./max	W	0.1 <sup>3)</sup> / 200 (10 mW / 12 W) <sup>1)</sup> (see limit curve for arc-free operation)
2.6 Switching capacity to IEC/EN 60947-5-1		
AC 15 <sup>4)</sup>	AC V/A	NO: 250 / 2    NC: 250 / 1
AC 15 <sup>5)</sup>	AC V/A	NO: 250 / 3    NC: 250 / 2
DC 13 <sup>4)</sup>	DC V/A	NO: 24 / 1    NC: 24 / 1
DC 13 <sup>4)</sup> at 0.1 Hz	DC V/A	NO: 24 / 4    NC: 24 / 4
to UL 508		B300
2.7 Electrical life		at 1 s On, 1 s Off (see contacts service life)
at AC 230 V, 5 A, $\cos\phi = 1$	switching cycles	> 3 x 10 <sup>5</sup> AgSnO <sub>2</sub> > 2 x 10 <sup>5</sup> AgNi 10
at AC 230 V, 8 A, $\cos\phi = 1$	switching cycles	> 1.5 x 10 <sup>5</sup> AgSnO <sub>2</sub> > 10 <sup>5</sup> AgNi 10
2.8 Switching frequency max	switching cycles / s	10
2.9 Response time / Release time	ms	typically 20 / typically 6
2.10 Contact force	cN	≥ 15
2.14 Contact gap	mm	> 0.5 <sup>2)</sup>
<b>3.0 Other</b>		
3.1 Mechanical life	switching cycles	≥ 10 <sup>7</sup>
3.2 Temperature range	°C	- 40 ... + 70
3.3 Degree of protection, housing		Solder line proof RT II
3.4 Test procedure		A (group mounting)
3.5 Vibration resistance		5 ... 55 Hz; amplitude; 2 g max. IEC/EN 60068-2-6
3.6 Climate resistance		40 / 070 / 04; A / B / D IEC/EN 60068-1
3.7 Short circuit strength 1 kA / AC 250 V	AgSnO <sub>2</sub> AgNi	NO: 10 A gL / NC: 10 A gL IEC/EN 60947-5-1 NO: 10 A gL / NC: 6 A gL IEC/EN 60947-5-1

<sup>1)</sup> Values for AgNi-contacts + 5 µm Au

<sup>3)</sup> Typical values for AgSnO<sub>2</sub> and AgNi

<sup>2)</sup> over entire service life, even when under fault and at 1.4 x  $U_N$

<sup>4)</sup> Values for AgNi-Contacts

<sup>5)</sup> Values for AgSnO<sub>2</sub>-contacts



## Technical Data

3.8	Insulation acc. to IEC 60664-1, EN 50178		
	Rated insulation voltage	AC V	250
	Pollution degree		3
	Overvoltage category		III
	Test voltage		
	Contact-coil (1 min)	AC kV eff.	≥ 4
	Contact-contact (1min)	AC kV eff.	≥ 2,5
	Open contact acc. to DIN EN 61810-1	AC kV eff.	1.5
	Transient voltage		
	Contact-coil (1,2 - 50 μs)	kV	≥ 6
	Clearance and creepage distances	mm	≥ 8
3.9	Weight	g	approx. 35
<b>4.0 Packing</b>			
4.1	on cardboard	piece	30
4.2	in case package	piece	150
<b>5.0 Solder method</b>			
5.1	Solder method /-temperature /-duration	°C / s	Wafer soldering / 260 / 5

## Design Versions

OA 5611				
U <sub>N</sub> (DC V)	Voltage range (DC V)	R <sub>Spule</sub> Ω ± 10%	.48	.52
			3NO / 1NC	2NO / 2NC
AgNi-contacts + 0,2 μm Au				
6	4,5 ... 8,4	51	3121	3104
12	9,0 ... 16,8	205	3122	3102
24	18,0 ... 33,6	805	3123	3103
48	36,0 ... 67,2	3 290	3124	3105
60	45,0 ... 84,0	5 150	3125	3106
110	82,5 ... 154,0	17 300	3126	3107
AgNi-contacts + 5 μm Au				
6	4,5 ... 8,4	51	3131	3111
12	9,0 ... 16,8	205	3132	3112
24	18,0 ... 33,6	805	3133	3113
48	36,0 ... 67,2	3 290	3134	3114
60	45,0 ... 84,0	5 150	3135	3115
110	82,5 ... 154,0	17 300	3136	3116

## Ordering Example

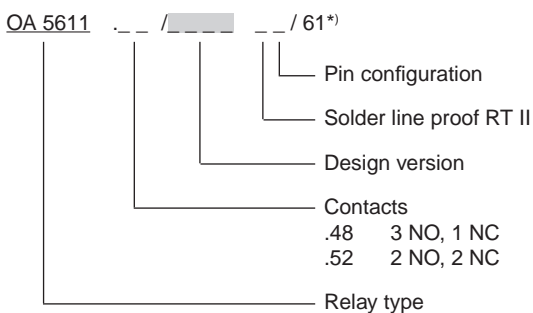

\*) / 61 cURus approval

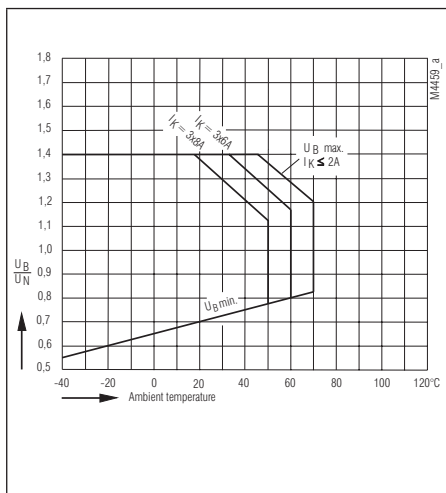

Operating voltage limit curve OA 5611

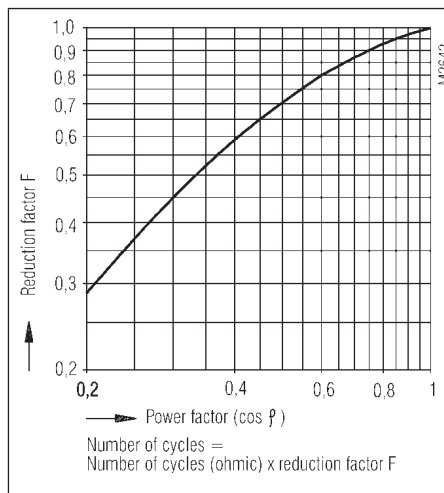

Reduction factor for inductive loads

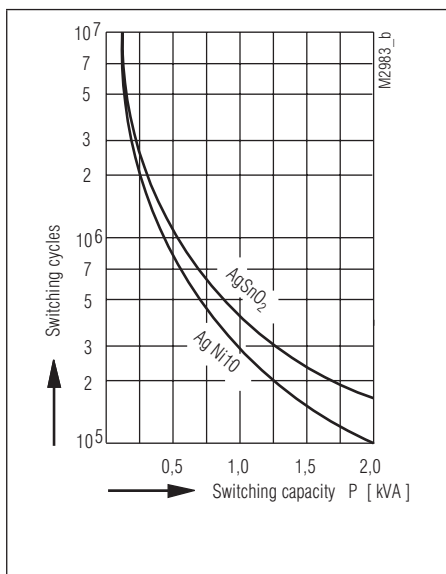

Contact service life

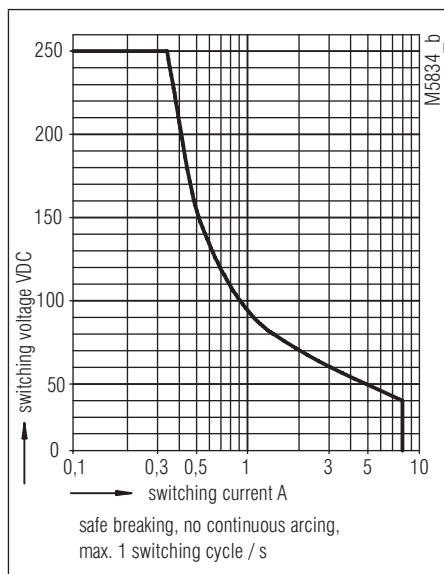

Limit curve for arc-free operation (load limit curve)

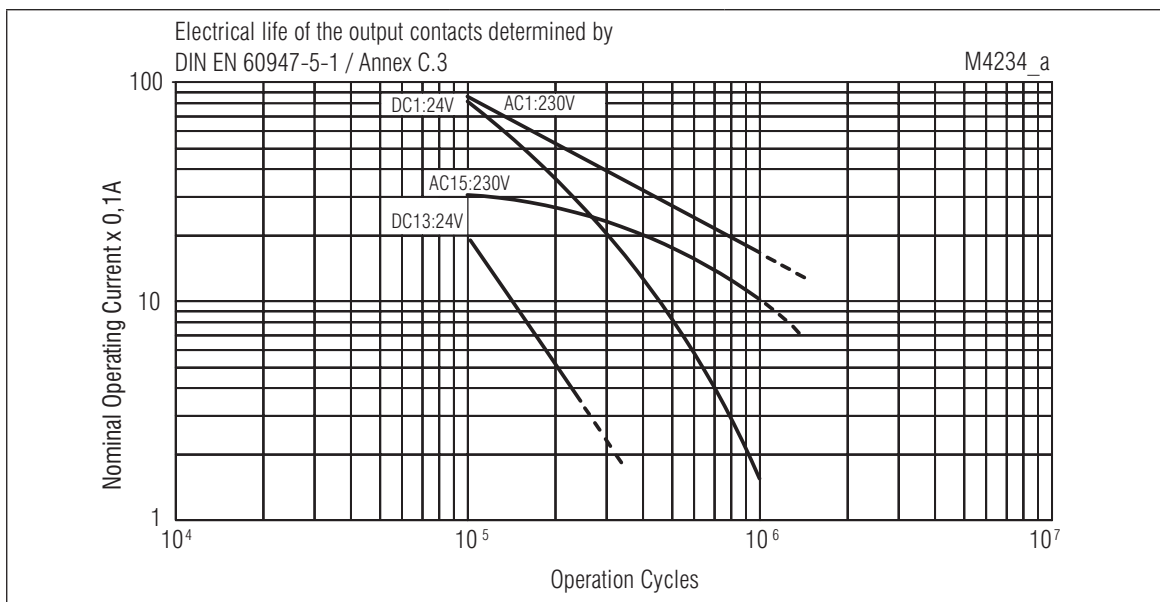

Electrical life for contact material AgNi

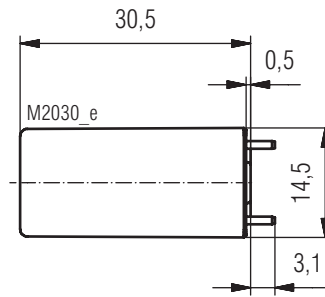
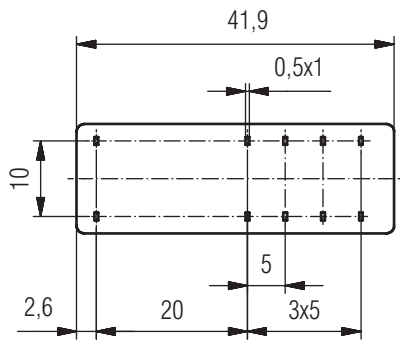

Drilling plan (solder side)

Pin arrangement OA 5611.52/...L1 2NO / 2NC

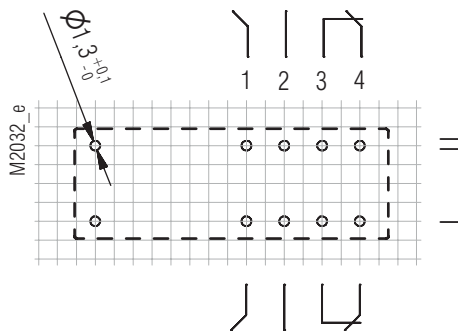

Pin arrangement OA 5611.52/...L4 2NO / 2NC

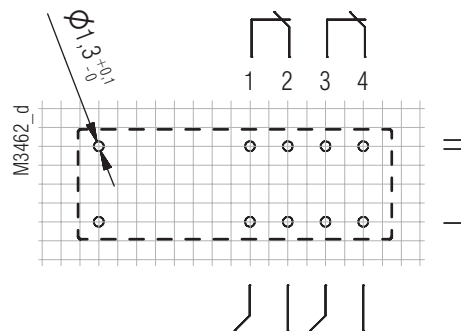

Pin arrangement OA 5611.52/...L5 2NO / 2NC

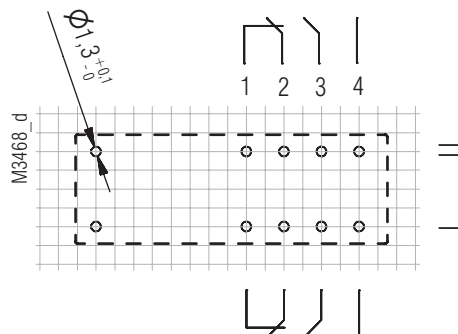

Pin arrangement OA 5611.48/...L1 3NO / 1NC

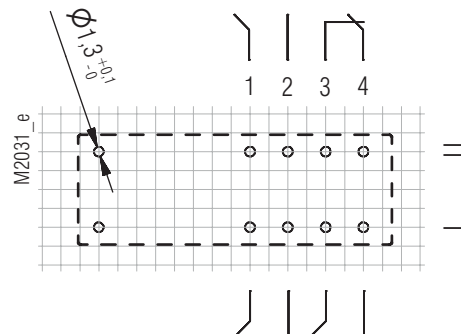

Pin arrangement OA 5611.48/...L4 3NO / 1NC

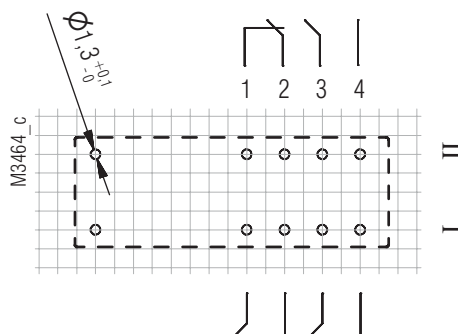

Pin arrangement OA 5611.28 1NO / 3NC

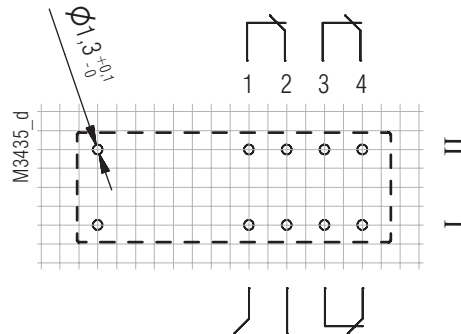

Connection for basic grid dimensions 2.5 mm as well as 2.54 mm according to IEC/EN 60097 and IEC 60326 average

Socket ET 1415.031

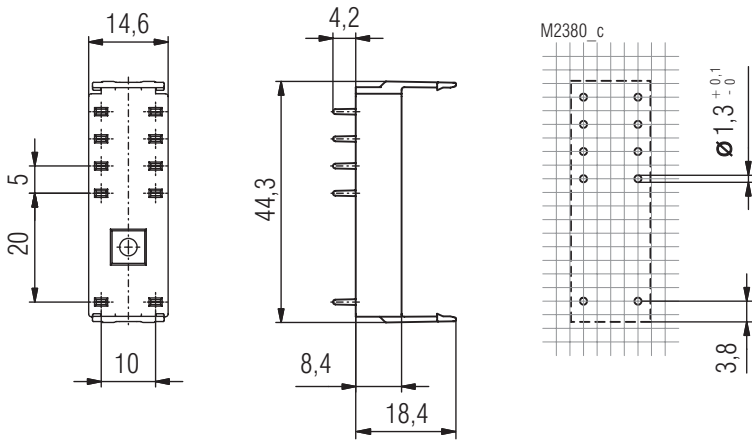

Article number: 0049512

Gold plated double contacts  
see separate datasheet

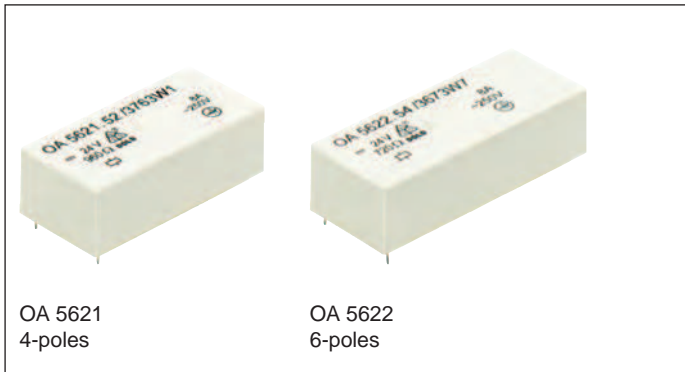

- According to DIN EN 61810-1, IEC 61810-3
- With forcibly guided contacts
- Clearance and creepage distances:  
contact - contact  $\geq 5,5$  mm
- Low rated power consumption and holding power
- High mechanical service life
- High temperature range
- High thermal continuous current
- 15,5 mm height
- Version with double contacts possible, AgNi 0.15 + 5  $\mu$ m Au-contacts

### Applications

- To be used in electrical circuits for safety applications
- Escalators and walkways
- Elevators for men and load
- Press controls
- Railway technology
- Medical technology

### Approvals and Markings

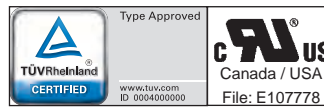

### Technical Data

Relay type		OA 5621	OA 5622	OA 5622.50
<b>1.0 Coil</b>				
1.1 Nominal voltage	DC V	6, 12, 24, 48, 60, 110 (others on request)		
1.2 Nominal consumption	W	0.6	0.8	0.9
1.11 Voltage range	$U_N$	0.75 ... 1.4		
1.12 Thermal resistance	K/W	55 (mounting distance between relays $\geq 5$ mm)		
1.13 Holding Power (at 0.5 x $U_N$ )	W	0.15	0.2	0.225
<b>2.0 Contacts</b>				
2.1 Contact arrangement		2 NO / 2 NC 3 NO / 1 NC	3 NO / 3 NC 4 NO / 2 NC 5 NO / 1 NC	2 NO / 4 NC
2.2 Contact material		AgSnO <sub>2</sub> + 0.2 $\mu$ m Au; AgNi + 0.2 $\mu$ m Au, AgNi + 5 $\mu$ m Au		
2.3 Rated insulation voltage	AC V	250		
Switching voltage min./max	V	AC/DC 10 / DC 250, AC 400 (AC/DC 2 V / 60 V) <sup>1)</sup>		
2.4 Limiting continuous current $I_{th}$	A	3 x 8	5 x 8 (s. operating voltage limit curve.)	
Switching current min./max	A		10 mA <sup>4)</sup> / 8 (2 mA / 0.3 A) <sup>1)</sup>	
2.5 Switching power min./max.	VA	0.1 <sup>4)</sup> / 2000 (10 mVA / 12 VA) <sup>1)</sup>		
Switching power min./max.	W	0.1 <sup>4)</sup> / 200 (10 mW / 12 W) <sup>1)</sup> (see limit curve for arc-free operation)		
2.6 Switching capacity to IEC/EN 60947-5-1				
AC 15 <sup>7)</sup>	AC V/A		NO: 250 / 3	NC: 250 / 2
AC 15 <sup>6)</sup>	AC V/A		NO: 250 / 5	NC: 250 / 2
DC 13 <sup>7)</sup>	DC V/A		NO: 24 / 2	NC: 24 / 2
DC 13 <sup>7)</sup> at 0.1 Hz to UL 508	DC V/A		NO: 24 / 4	NC: 24 / 4
			B300 / Q 300	
2.7 Electrical life		at 1 s On, 1 s Off (see contacts service life)		
at AC 230 V, 5 A, $\cos\phi = 1$	switching cycles	$> 3 \times 10^5$ AgSnO <sub>2</sub>	$> 2.2 \times 10^5$ AgNi	
at AC 230 V, 8 A, $\cos\phi = 1$	switching cycles	$> 1.5 \times 10^5$ AgSnO <sub>2</sub>	$> 10^5$ AgNi	
at DC 24 V, 5 A ohmic	switching cycles	$> 2 \times 10^5$ AgSnO <sub>2</sub>	$> 1.5 \times 10^5$ AgNi	
at DC 24 V, 8 A ohmic	switching cycles	$> 10^5$ AgSnO <sub>2</sub>	$> 0.75 \times 10^5$ AgNi	
2.8 Switching frequency max	switching cycles/s	10		
2.9 Response time / Release time	ms	typically 12 / typically 8		
2.10 Contact force	cN	$\geq 8$		
2.14 Contact gap	mm	$> 0.5$ <sup>5)</sup>		
<b>3.0 Other</b>				
3.1 Mechanical life	switching cycles	$> 20 \times 10^6$		
3.2 Temperature range	$^{\circ}$ C	- 40 ... + 80		
3.3 Degree of protection, housing		Wash proof RT III		
3.4 Test procedure		A (group mounting)		
3.5 Vibration resistance		10 ... 200 Hz; 0,35 mm amplitude; 5 g max. IEC/EN 60068-2-6		
3.6 Climate resistance		40 / 080 / 04; A / B / D IEC/EN 60068-1		
3.7 Short circuit strength 1 kA / AC 250 V	AgSnO <sub>2</sub> AgNi	NO: 10 AgL / NC: 10 AgL IEC/EN 60947-5-1 NO: 10 AgL / NC: 6 AgL IEC/EN 60947-5-1		

<sup>1)</sup> Values for AgNi-contacts + 5  $\mu$ m Au    <sup>2)</sup> at  $T_u = 60^{\circ}$ C  $> 10^5$

<sup>5)</sup> over entire service life, even when under fault and at 1.4 x  $U_N$

<sup>3)</sup> at  $T_u = 60^{\circ}$ C  $> 0,75 \times 10^5$

<sup>6)</sup> Values for AgSnO<sub>2</sub>-contacts

<sup>4)</sup> Typical values

<sup>7)</sup> Values for AgNi-contacts

## Technical Data

3.8	Insulation acc. to IEC 60664-1, EN 50178		
	Rated insulation voltage	AC V	250
	Pollution degree		2
	Overvoltage category		III
	Test voltage		
	Contact-coil (1 min)	AC kV eff.	≥ 4
	Contact-contact (1min)	AC kV eff.	≥ 4
	Open contact acc. to DIN EN 61810-1	AC kV eff.	1.5
	Transient voltage		
	Contact-coil (1,2 - 50 μs)	kV	≥ 6
	Clearance and creepage distance	mm	≥ 5.5
3.9	Weight	g	approx. 35      approx. 38      approx. 38
<b>4.0 Packing unit</b>			
4.1	on cardboard in slipcase	piece	25      20      20
4.2	in case package	piece	250      200      200
<b>5.0 Solder method</b>			
5.1	Solder method /-temperature /-duration	°C / s	Wave soldering / 260 / 5

## Design Versions

U <sub>N</sub> (DC V)	Voltage range (DC V)	OA 5621			OA 5622					
		R <sub>Coil</sub> Ω ± 10%	.48 3NO, 1NC	.52 2NO, 2NC	R <sub>Coil</sub> Ω ± 10%	.18 3NO, 3NC	.54 4NO, 2NC	.60 5NO, 1NC	R <sub>Coil</sub> Ω ± 10%	.50 2NO, 4NC
AgSnO <sub>2</sub> -contacts + 0,2 μm Au										
6	4,5 ... 8,4	60	3721	3751	45	3601	3661	3691	38	3631
12	9,0 ... 16,8	240	3722	3752	180	3602	3662	3692	150	3632
24	18,0 ... 33,6	960	3723	3753	720	3603	3663	3693	600	3633
48	36,0 ... 67,2	3840	3724	3754	2880	3604	3664	3694	2425	3634
60	45,0 ... 84,0	6000	3725	3755	4500	3605	3665	3695	3790	3635
110	82,5 ... 154,0	20000	3726	3756	15125	3606	3666	3696	12735	3636
AgNi-contacts + 0,2 μm Au										
6	4,5 ... 8,4	60	3731	3761	45	3611	3671	3701	38	3641
12	9,0 ... 16,8	240	3732	3762	180	3612	3672	3702	150	3642
24	18,0 ... 33,6	960	3733	3763	720	3613	3673	3703	600	3643
48	36,0 ... 67,2	3840	3734	3764	2880	3614	3674	3704	2425	3644
60	45,0 ... 84,0	6000	3735	3765	4500	3615	3675	3705	3790	3645
110	82,5 ... 154,0	20000	3736	3766	15125	3616	3676	3706	12735	3646
AgNi-contacts + 5 μm Au										
6	4,5 ... 8,4	60	3741	3771	45	3621	3681	3711	38	3651
12	9,0 ... 16,8	240	3742	3772	180	3622	3682	3712	150	3652
24	18,0 ... 33,6	960	3743	3773	720	3623	3683	3713	600	3653
48	36,0 ... 67,2	3840	3744	3774	2880	3624	3684	3714	2425	3654
60	45,0 ... 84,0	6000	3745	3775	4500	3625	3685	3715	3790	3655
110	82,5 ... 154,0	20000	3746	3776	15125	3626	3686	3716	12735	3656

## Ordering example

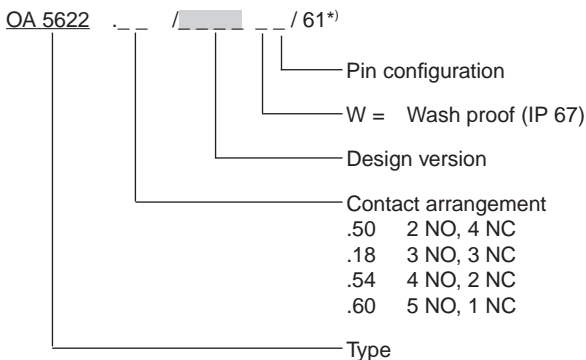

**On request  
version with double contacts**

\*) / 61 cURus approval

Characteristics

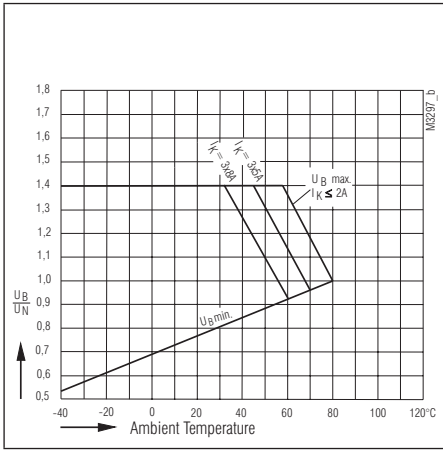

Operating voltage limit curve OA 5621

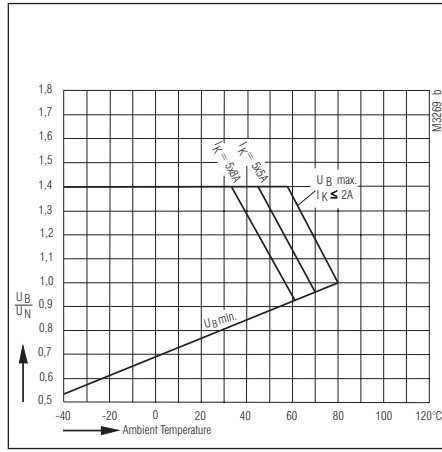

Operating voltage limit curve OA 5622

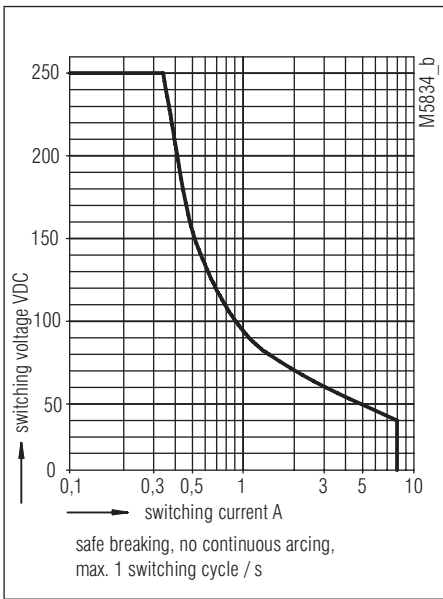

Limit curve for arc-free operation (load limit curve)

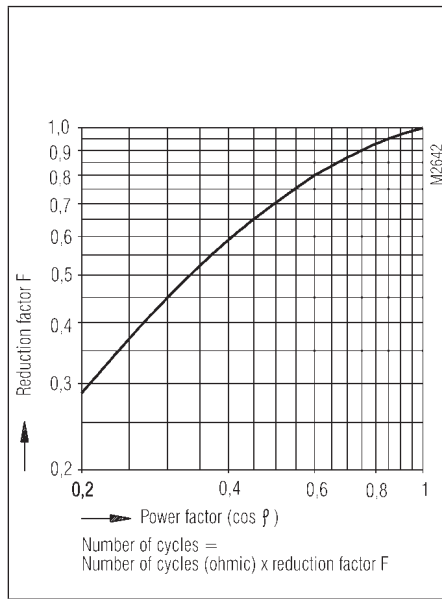

Reduction factor for inductive loads

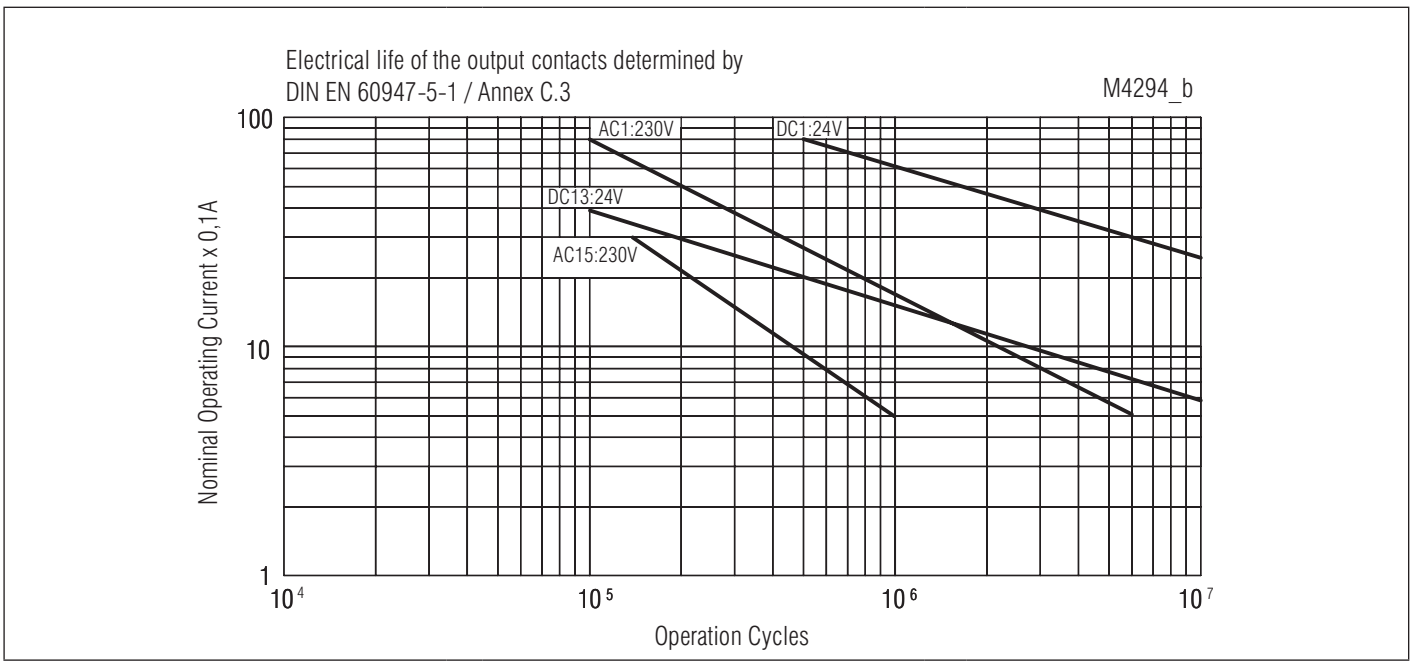

Electrical life

Pin Configuration W1 / W5

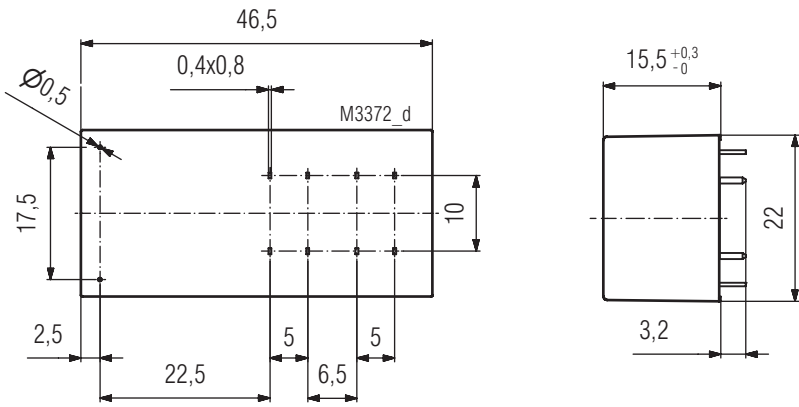

Pin Configuration sW1  
Drilling plan (solder side)

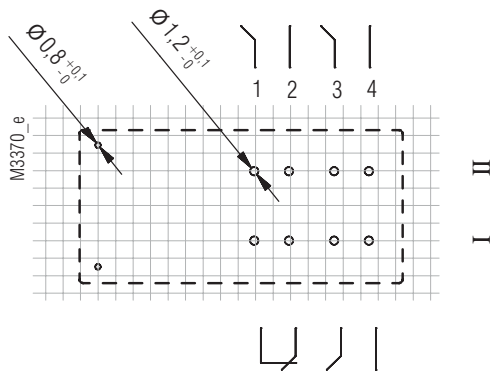

OA5621.48/\_\_\_W1 3NO / 1NC

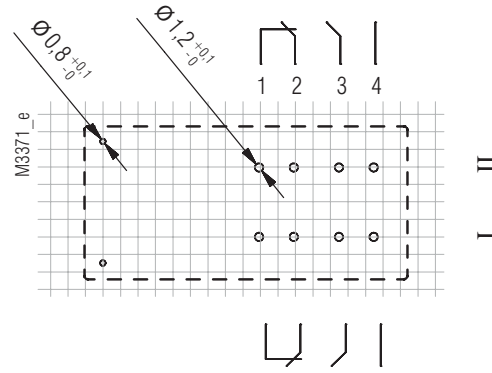

OA5621.52/\_\_\_W1 2NO / 2NC

Pin Configuration D5  
Drilling plan (solder side)

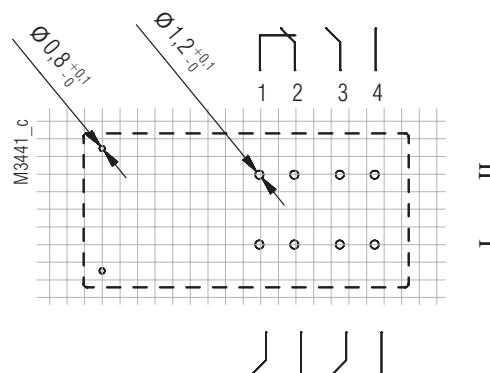

OA5621.48/\_\_\_W5 3NO / 1NC

Connection for basic grid dimensions 2.50 mm as well as 2.54 mm according to IEC/EN 60 097, IEC 60 326



Pin Configuration W7

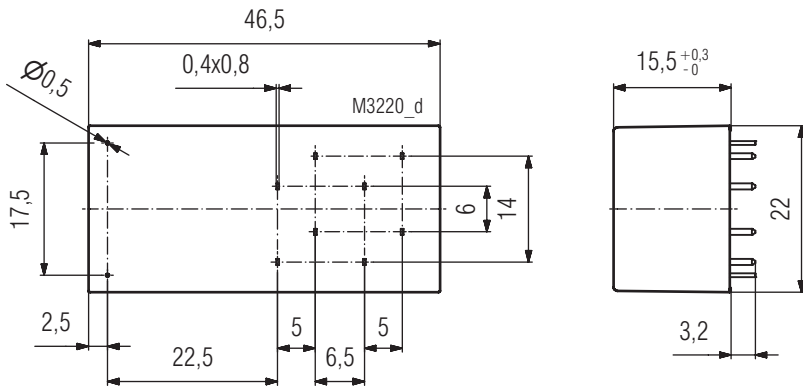

Pin Configurations W7  
Drilling plan (solder side)

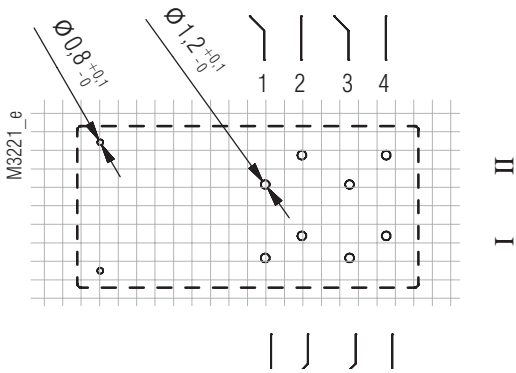

OA5621.48/\_\_\_W7 3NO / 1NC

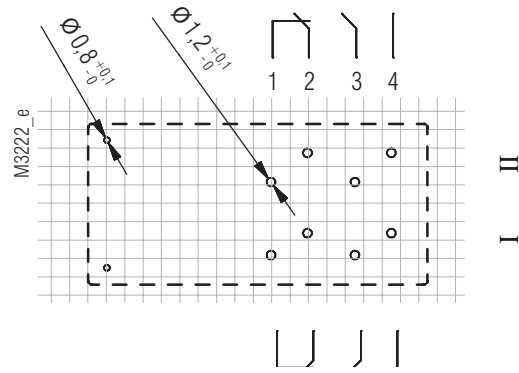

OA5621.52/\_\_\_W7 2NO / 2NC

Pin Configuration W1

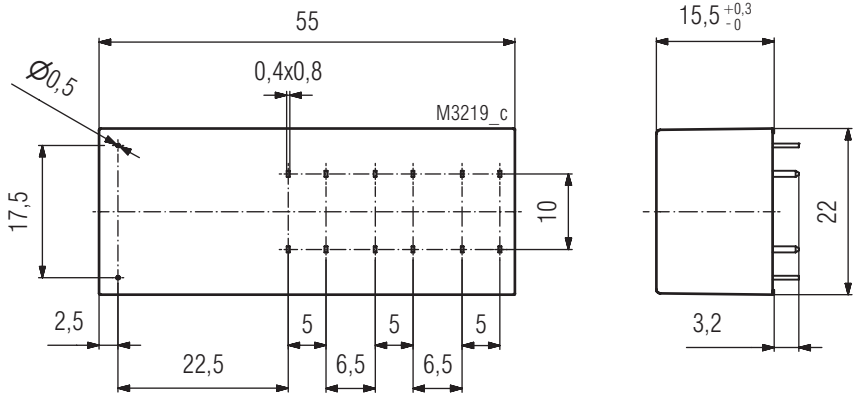

Pin Configurations W1  
Drilling plan (solder side)

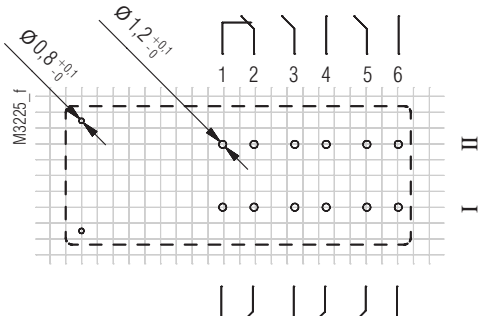

OA 5622.18/\_\_\_W1 3NO / 3NC

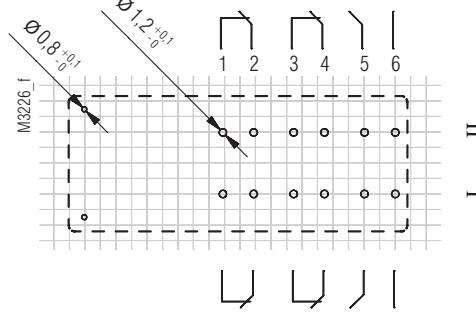

OA 5622.50/\_\_\_W1 2NO / 4NC

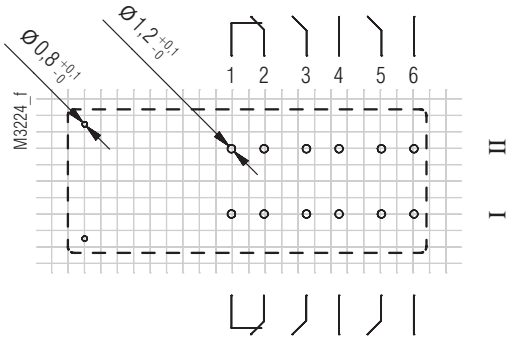

OA 5622.54/\_\_\_W1 4NO / 2NC

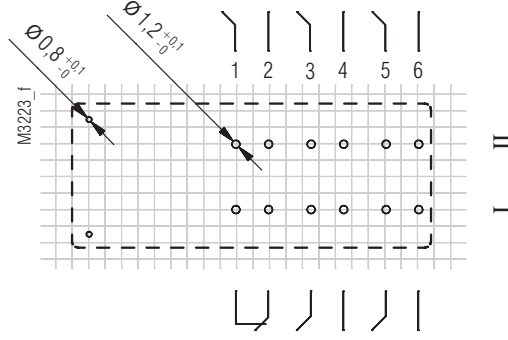

OA 5622.60/\_\_\_W1 5NO / 1NC

Pin Configuration W5  
Drilling plan (solder side)

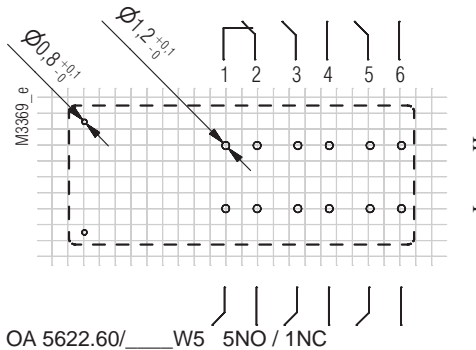

OA 5622.60/\_\_\_W5 5NO / 1NC

Connection for basic grid dimensions 2.50 mm as well as 2.54 mm according to IEC/EN 60 097, IEC 60 326

Pin Configuration W7

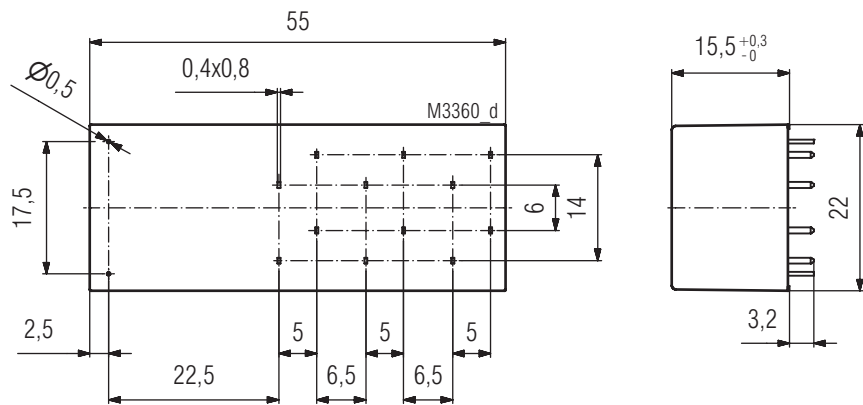

Pin Configurations W7  
Drilling plan (solder side)

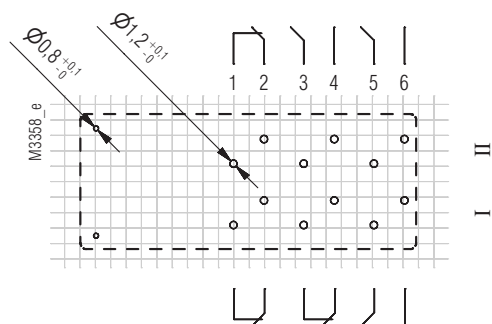

OA 5622.18/\_\_\_W7 3NO / 3NC

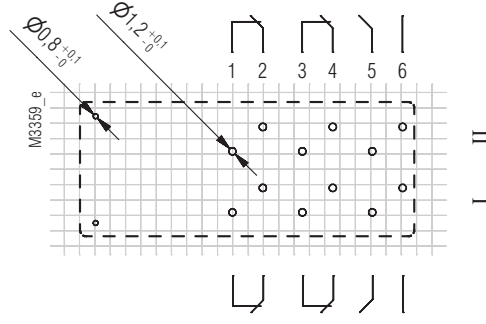

OA 5622.50/\_\_\_W7 2NO / 4NC

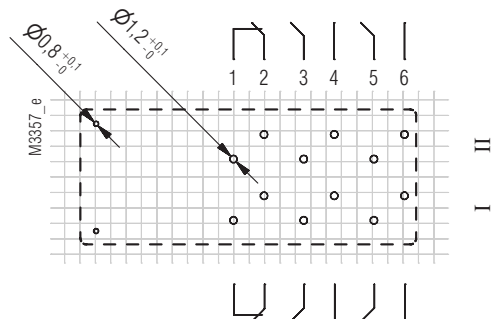

OA 5622.54/\_\_\_W7 4NO / 2NC

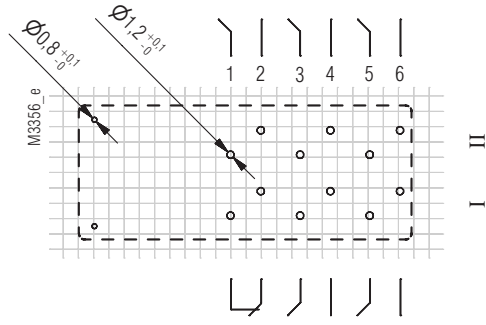

OA 5622.60/\_\_\_W7 5NO / 1NC

Pin Configurations W8  
Drilling plan (solder side)

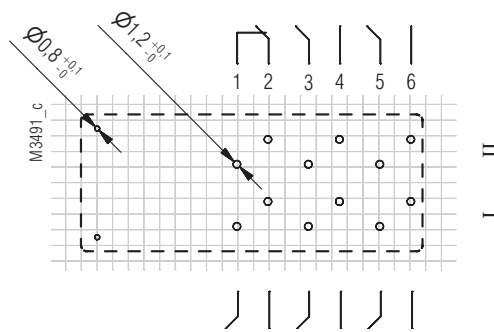

OA 5622.60/\_\_\_W8 5NO / 1NC

Connection for basic grid dimensions 2.50 mm as well as 2.54 mm according to IEC/EN 60 097, IEC 60 326

**Notes**

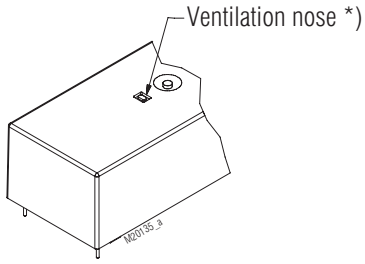

\*) When using the maximum switching capacity it is recommended to open the relay at the indicated position.

**Accessories**

**Socket ET 1415.035**

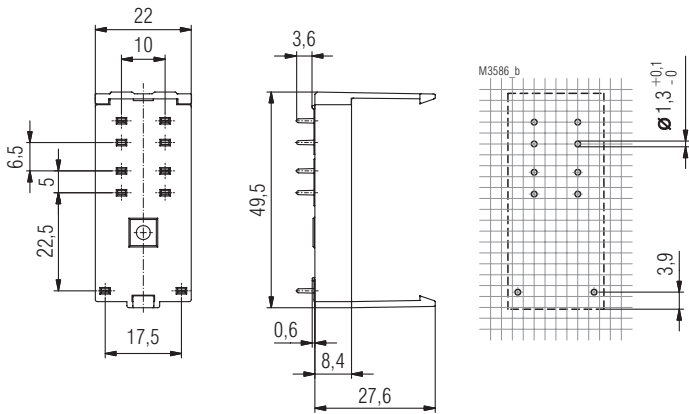

Article number: 0059509

**Socket ET 1415.037**

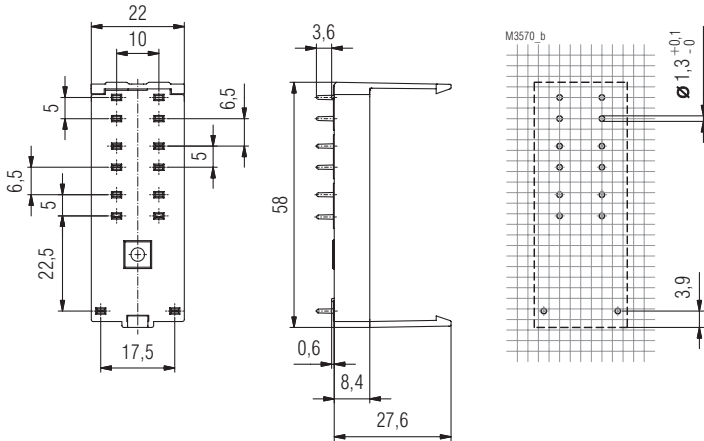

Article number: 0059275



- According to DIN EN 61810-1, DIN EN 61810-3
- With forcibly guided contacts
- Clearance and creepage distances:  
contact - contact  $\geq 5,5$  mm
- Low rated power consumption and holding power
- High mechanical service life
- High temperature range
- High thermal continuous current
- Height: 15.8 mm

### Applications

- Railway and signalling applications
- Automation
- Medical devices
- Radio- and telecontrol applications
- Fuel applications
- Process applications
- Elevator applications

### Approvals and Markings

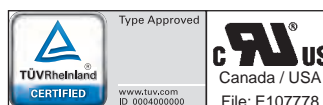

### Technical Data

Relay type		OA 5623
<b>1.0 Coil</b>		
1.1 Nominal voltage	DC V	6, 12, 24, 48, 60, 110 (others on request)
1.2 Nominal consumption	W	approx. 1.2
1.11 Voltage range	$U_N$	0.8 ... 1.2
1.13 Holding Power (at 0.5 x $U_N$ )	W	0.3
<b>2.0 Contacts</b>		
2.1 Contact arrangement		7 NO / 1 NC 6 NO / 2 NC 5 NO / 3 NC 4 NO / 4 NC
2.2 Contact material		AgSnO <sub>2</sub> + 0.2 $\mu$ m Au; AgNi + 0.2 $\mu$ m Au, AgNi + 5 $\mu$ m Au
2.3 Rated insulation voltage	AC V	250
Switching voltage min./max	V	AC/DC 10 / DC 250, AC 400 (AC/DC 2 V / 60 V) <sup>3)</sup>
2.4 Limiting continuous current $I_{th}$	A	7 x 8 <sup>6)</sup> (see Operating voltage limit curve)
Switching current min./max	A	10 mA <sup>4)</sup> / 8 (2 mA / 0,3 A) <sup>3)</sup>
2.5 Switching power min./max	VA	0.1 <sup>4)</sup> / 2000 (10 mVA / 12 VA) <sup>3)</sup>
Switching power min./max	W	0.1 <sup>4)</sup> / 200 (10 mW / 12 W) <sup>3)</sup>
2.6 Switching capacity to IEC/EN 60947-5-1		
AC 15 <sup>5)</sup>	AC V/A	NO: 250 / 3 NC: 250 / 2
AC 15 <sup>2)</sup>	AC V/A	NO: 250 / 5 NC: 250 / 2
DC 13 <sup>5)</sup>	DC V/A	NO: 24 / 2 NC: 24 / 2
DC 13 <sup>5)</sup> at 0.1 Hz	DC V/A	NO: 24 / 4 NC: 24 / 4
2.7 Electrical life		at 1 s On, 4 s Off (see contacts service life)
at AC 230 V, 8 A, $\cos\phi = 1$	switching cycles	$> 10^5$ AgNi
at DC 24 V 8 A ohmic	switching cycles	$0.75 \times 10^5$ AgNi
2.8 Switching frequency max	switching cycles/s	10
2.9 Response time / Release time	ms	typically 16 / typically 8
2.10 Contact force	cN	$\geq 8$
2.14 Contact gap	mm	1.0 ( $> 0.5$ <sup>1)</sup> )
<b>3.0 Other</b>		
3.1 Mechanical life	switching cycles	$20 \times 10^6$
3.2 Temperature range	$^{\circ}$ C	- 40 ... + 80
3.3 Degree of protection, housing		Wash proof RT III
3.4 Test procedure		A (group mounting)
3.5 Vibration resistance		10 ... < 60 Hz, a = 0,35 mm IEC/EN 60068-2-6
Criteria: contact opening $\geq 10$ $\mu$ s		60 ... 200 Hz, 5g (all contacts) IEC/EN 60068-2-6
3.6 Climate resistance		40 / 080 / 04 A / B / D IEC/EN 60068-1
3.7 Short circuit strength		1 kA / AC 250 V IEC/EN 60947-5-1 <sup>2) 5)</sup>
SCPD / Fuse		NO contact: 10 A gG/gL / NC contact: 6 A gG/gL IEC/EN 60269-1 <sup>2) 5)</sup>

<sup>1)</sup> Over entire service life, even when under fault and at 1.2  $U_N$

<sup>3)</sup> Typical values for AgNi-contacts + 5  $\mu$ m Au

<sup>5)</sup> Values for AgNi-contacts

<sup>2)</sup> Values for AgSnO<sub>2</sub>-contacts

<sup>4)</sup> Typical values

<sup>6)</sup> See notes

## Technical Data

3.8	Insulation acc. to IEC 60664-1, EN 50178		
	Rated insulation voltage	AC V	250
	Pollution degree		2
	Overtoltage category		III
	Test voltage		
	Contact-coil (1 min)	AC kV eff.	≥ 4
	Contact-contact (1min)	AC kV eff.	≥ 4
	between open contacts	AC kV eff.	≥ 1,5
	Transient voltage		
	Contact-coil (1.2 - 50 µs)	kV	≥ 6
	Clearance and creepage distance	mm	≥ 5.5
3.9	Weight	g	approx. 39.5
<b>4.0 Packing unit</b>			
4.1	on cardboard in slipcase	piece	15
4.2	in case package	piece	150
<b>5.0 Solder method</b>			
5.1	Solder method /-temperature /-duration	°C / s	Wafer soldering / 260 / 5

## Design Versions

U <sub>N</sub> (DCV)	Voltage range (DC V)	R <sub>Coil</sub> at 20° C Ω±10%	OA 5623			
			.57	.58	.59	.63
			4S, 4Ö	5S, 3Ö	6S, 2Ö	7S, 1Ö
AgNi-contacts + 0,2µm Au						
6	4,8 ... 7,2	31	8001	8201	8401	8601
12	9,6 ... 14,4	120	8002	8202	8402	8602
24	19,2 ... 28,8	500	8003	8203	8403	8603
48	38,4 ... 57,6	2000	8004	8204	8404	8604
60	48,0 ... 72,0	2880	8005	8205	8405	8605
110	88,0 ... 132,0	10100	8006	8206	8406	8606
AgNi-contacts + 5 µm Au (goldplated contacts)						
6	4,8 ... 7,2	31	8101	8301	8501	8701
12	9,6 ... 14,4	120	8102	8302	8502	8702
24	19,2 ... 28,8	500	8103	8303	8503	8703
48	38,4 ... 57,6	2000	8104	8304	8504	8704
60	48,0 ... 72,0	2880	8105	8305	8505	8705
110	88,0 ... 132,0	10100	8106	8306	8506	8706
AgSnO <sub>2</sub> -contacts +0,2 µm Au						
6	4,8 ... 7,2	31	8151	8351	8551	8751
12	9,6 ... 14,4	120	8152	8352	8552	8752
24	19,2 ... 28,8	500	8153	8353	8553	8753
48	38,4 ... 57,6	2000	8154	8354	8554	8754
60	48,0 ... 72,0	2880	8155	8355	8555	8755
110	88,0 ... 132,0	10100	8156	8356	8556	8756

## Ordering Example

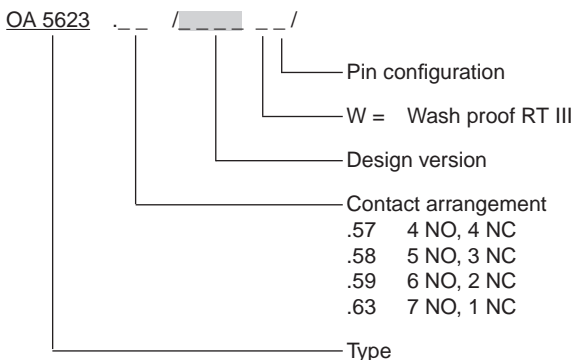

**On request  
version with double contacts**

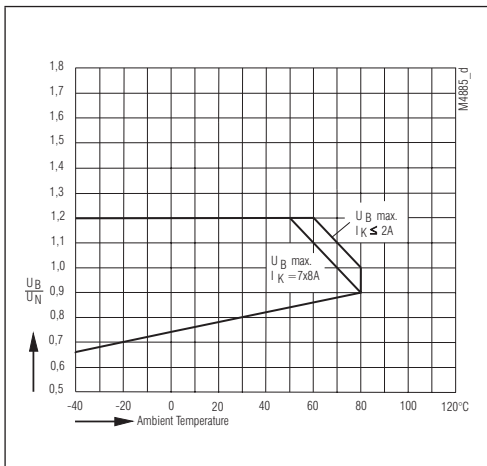

Operating voltage limit curve without influence through self-heating of surrounding components

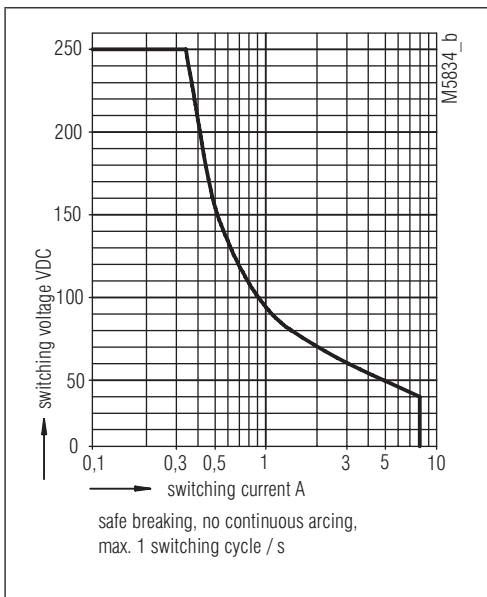

Limit curve for arc-free operation (load limit curve)

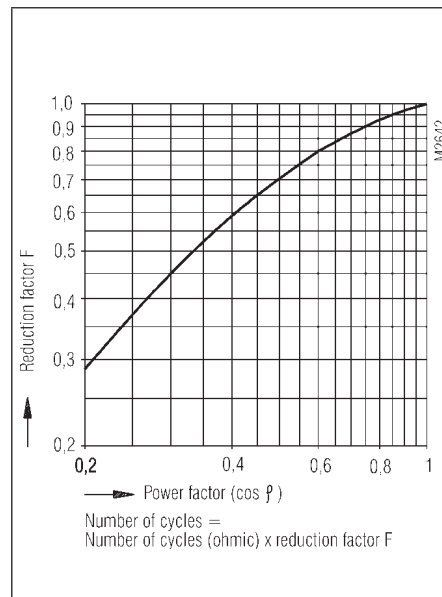

Reduction factor for inductive loads

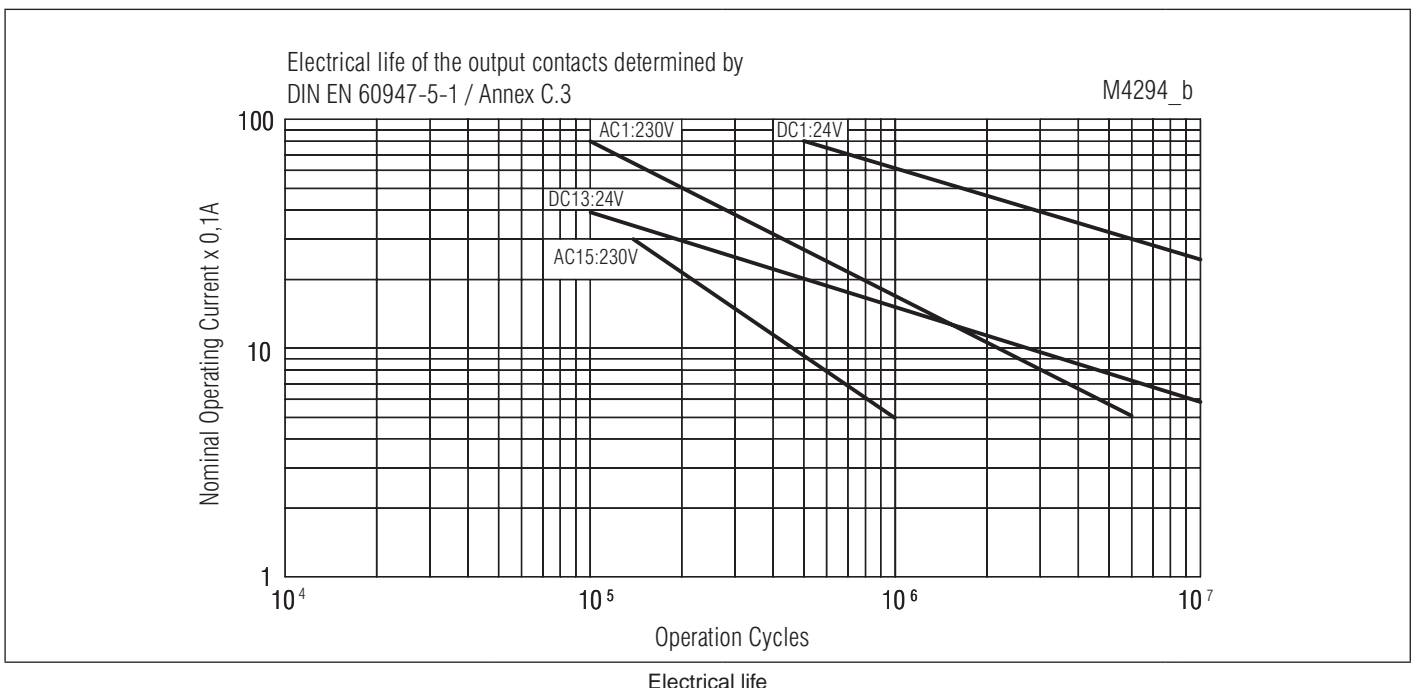

Pin configuration W1 / W5

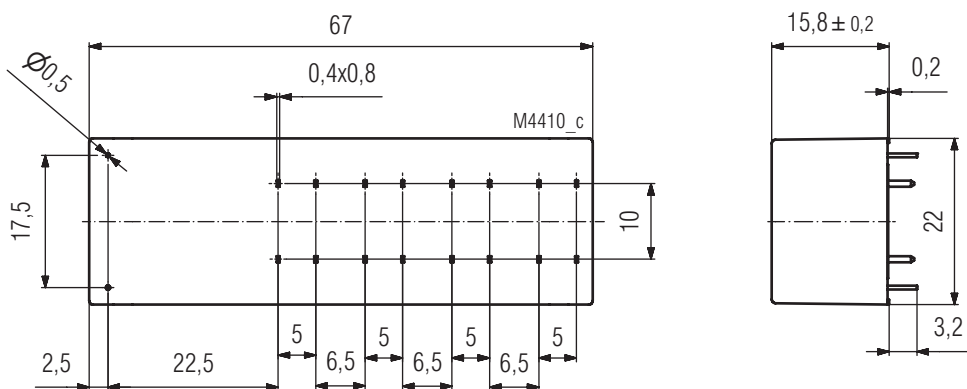

Pin configuration W1  
Drilling plan (solder side)

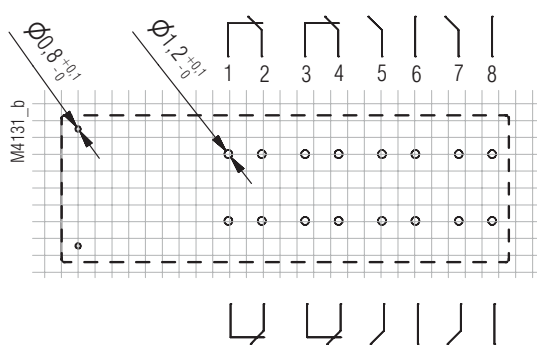

OA5623.57/\_\_\_W1 4NO/4NC

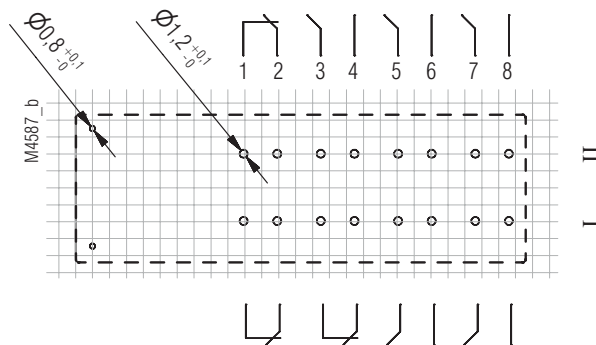

OA5623.58/\_\_\_W1 5NO/3NC

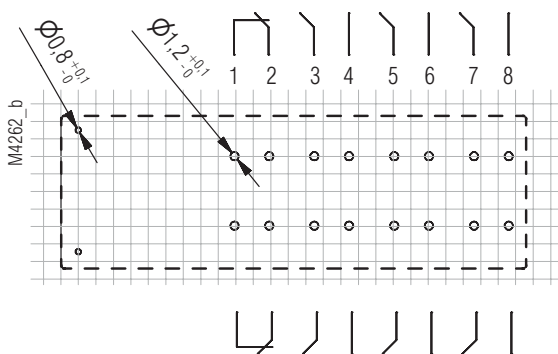

OA5623.59/\_\_\_W1 6NO/2NC

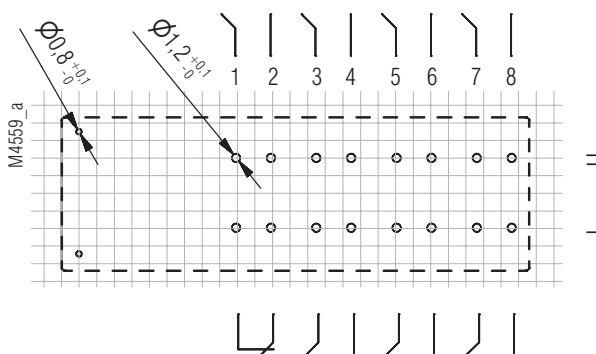

OA5623.63/\_\_\_W1 7NO/1NC

Pin configuration W5  
Drilling plan (solder side)

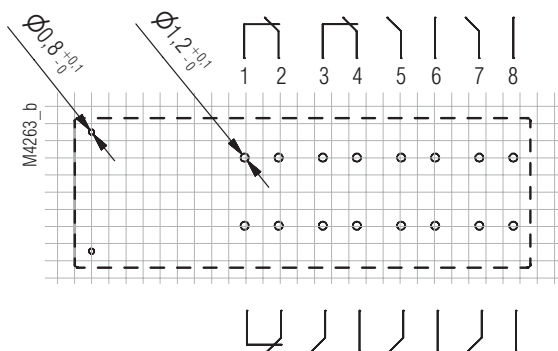

OA5623.58/\_\_\_W5 5NO/3NC

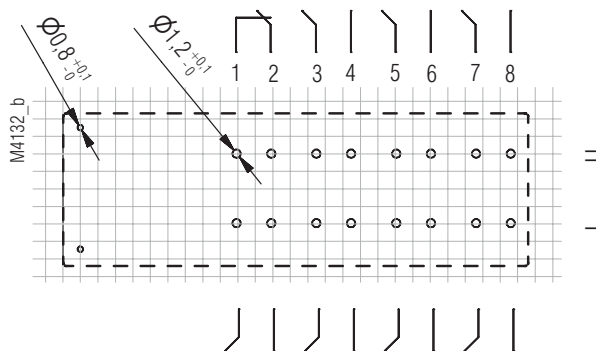

OA5623.63/\_\_\_W5 7NO/1NC

Connection for basic grid dimensions 2.50 mm as well as 2.54 mm according to IEC/EN 60 097, IEC 60 326



Pin configuration W7 / W8

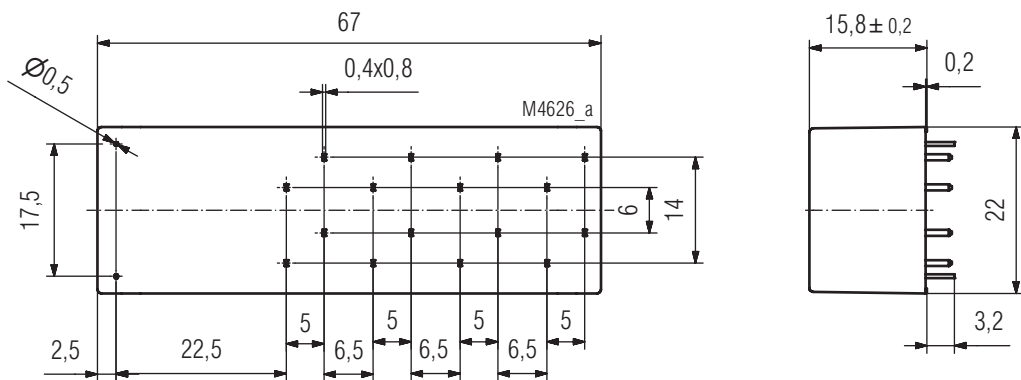

Pin configuration W7  
Drilling plan (solder side)

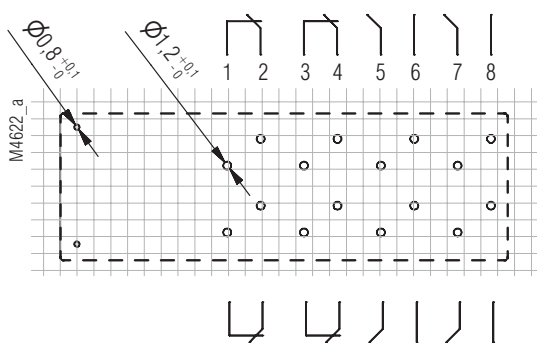

OA5623.57/\_\_\_W7 4NO/4NC

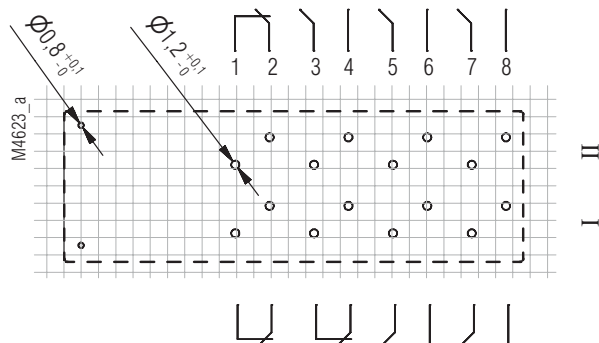

OA5623.58/\_\_\_W7 5NO/3NC

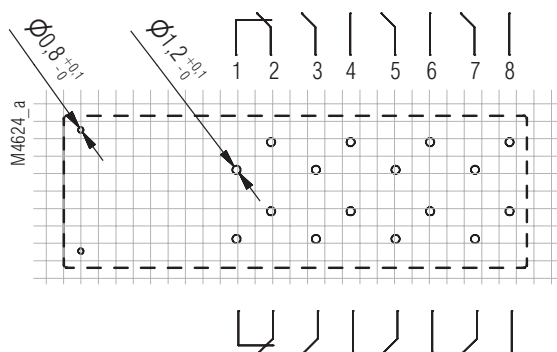

OA5623.59/\_\_\_W7 6NO/2NC

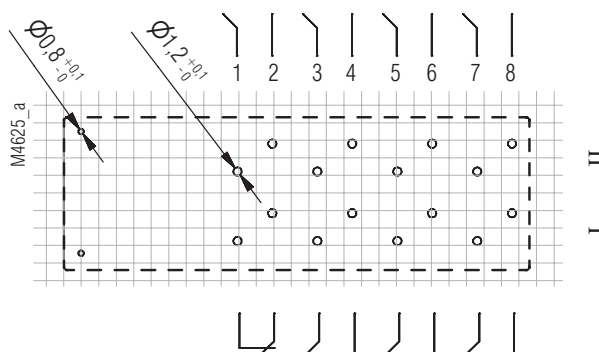

OA5623.63/\_\_\_W7 7NO/1NC

Pin configuration W8  
Drilling plan (solder side)

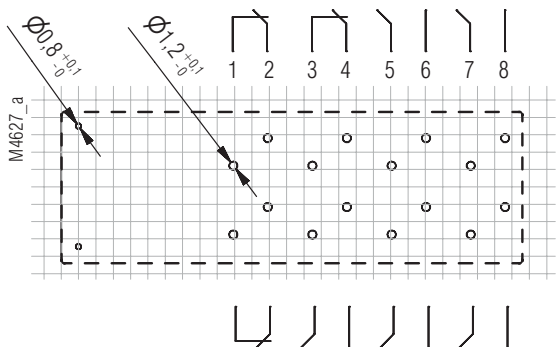

OA5623.58/\_\_\_W8 5NO/3NC

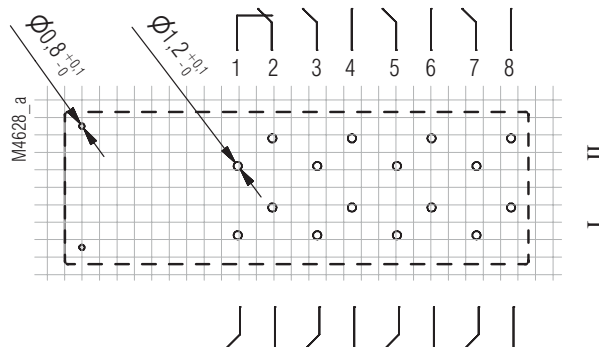

OA5623.63/\_\_\_W8 7NO/1NC

Connection for basic grid dimensions 2.50 mm as well as 2.54 mm according to IEC/EN 60 097, IEC 60 326

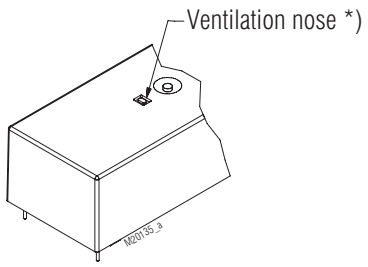

\*) When using the maximum switching capacity it is recommended to open the relay at the indicated position.

## Safety Relay with double contacts OA 5621, OA 5622

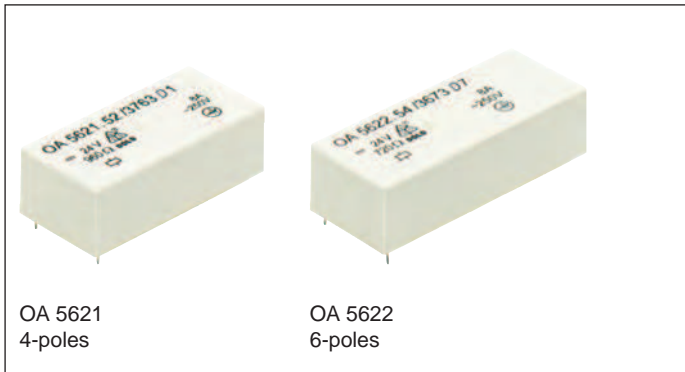

- According to DIN EN 61810-1, IEC 61810-3
- With forcibly guided contacts
- High switching safety because of gold plated double contacts
- Clearance and creepage distances:  
contact - contact  $\geq 5,5$  mm
- Low rated power consumption and holding power
- High mechanical service life
- High temperature range
- High thermal continuous current
- Voltage range  $0.75 \dots 1.2 U_N$
- 15.5 mm height

### Applications

- To be used in electrical circuits for safety applications
- Escalators and walkways
- Elevators for men and load
- Railway technology

### Approvals and Markings

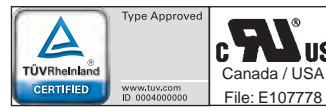

### Technical Data

Relay type		OA 5621	OA 5622	OA 5622.50
<b>1.0 Coil</b>				
1.1 Nominal voltage	DC V	6, 12, 24, 48, 60, 110 or others on request		
1.2 Nominal consumption	W	0.6	0.8	0.9
1.11 Voltage range	$U_N$	0.75 ... 1.2		
1.12 Thermal resistance	K/W	55 (mounting distance between relays $\geq 5$ mm)		
1.13 Holding capacity	mW	$\geq 150$	$\geq 200$	$\geq 225$
<b>2.0 Contacts</b>				
2.1 Contact arrangement		2 NO / 2 NC 3 NO / 1 NC	3 NO / 3 NC 4 NO / 2 NC 5 NO / 1 NC	2 NO / 4 NC
2.2 Contact material		AgNi + 5 $\mu$ m Au		
2.3 Rated insulation voltage	AC V	250		
Switching voltage min./max	V	AC/DC 2 V / AC/DC 60 V (AC 250 V, DC 220 V) <sup>1)</sup>		
2.4 Limiting continuous current $I_{th}$	A	3 x 5	5 x 5 (s. operating voltage limit curve)	
Switching current min./max	A	AC/DC 1 mA / 0.3 A (AC 5 A, DC 3 A) <sup>1)</sup>		
2.5 Switching power min./max.	VA	1 mVA / 7 VA (1250 VA) <sup>1)</sup>		
Switching power min./max.	W	1 mW / 7 W (120 W) <sup>1)</sup>		
2.6 Switching capacity to IEC/EN 60947-5-1				
AC 15	AC V/A		NO: 250 / 3	NC: 250 / 1
DC 13	DC V/A		NO: 24 / 2	NC: 24 / 2
at 0.1 Hz	DC V/A		NO: 24 / 4	NC: 24 / 4
to UL 508			B300 / Q 300	
2.7 Electrical life		at 1 s On, 1 s Off (see contacts service life)		
at AC 230 V, 5 A, $\cos\phi = 1$	switching cycles	$> 2 \times 10^5$ AgNi 0.15		
at DC 24 V, 3 A ohmic	switching cycles	$> 1.5 \times 10^5$ AgNi 0.15		
2.8 Switching frequency max	switching cycles / s	10		
2.9 Response time / Release time	ms	typically 12 / typically 8		
2.10 Contact force	cN	$\geq 8$		
2.13 Contact resistance	m $\Omega$	$\leq 100$ (DC 2 V, 100 mA)		
2.14 Contact gap	mm	$> 0.5$ <sup>2)</sup>		
<b>3.0 Other</b>				
3.1 Mechanical life	switching cycles	$> 20 \times 10^6$		
3.2 Temperature range	$^{\circ}$ C	- 40 ... + 80		
3.3 Degree of protection, housing		Wash proof RT III		
3.4 Test procedure		A (group mounting)		
3.5 Vibration resistance		NO: 10 ... 200 Hz; 10 g; NC: 10 ... 140 Hz $\leq 5$ g; IEC/EN 60068-2-6		
3.6 Climate resistance		40 / 080 / 04; A / B / D IEC/EN 60068-1		
3.7 Short circuit strength 1 kA / AC 250 V	AgNi	NO: 10 AgL / NC: 6 AgL IEC/EN 60947-5-1		

<sup>1)</sup> these higher values are possible but the gold plate will be destroyed

<sup>2)</sup> over entire service life, even when under fault and at  $1.2 \times U_N$

## Technical Data

3.8	Insulation acc. to IEC 60664-1, EN 50178		
	Rated insulation voltage	AC V	250
	Pollution degree		2
	Overvoltage category		III
	Test voltage		
	Contact-coil (1 min)	AC kV eff.	≥ 4
	Contact-contact (1min)	AC kV eff.	≥ 4
	Open contact acc. to DIN EN 61810-1	AC kV eff.	1.5
	Transient voltage		
	Contact-coil (1,2 - 50 μs)	kV	≥ 6
	Clearance and creepage distance	mm	≥ 5,5
3.9	Weight	g	approx. 35
			approx. 38
			approx. 38
4.0	<b>Packing unit</b>		
4.1	on cardboard in slipcase	piece	25
			20
			20
4.2	in case package	piece	250
			200
			200
5.0	<b>Solder method</b>		
5.1	Solder method /-temperature /-duration	°C / s	Wafer soldering / 260 / 5

## Design Versions

U <sub>N</sub> (DC V)	Voltage range (DC V)	OA 5621			OA 5622					
		R <sub>Coil</sub> Ω ± 10%	.48 3NO, 1NC	.52 2NO, 2NC	R <sub>Spule</sub> Ω ± 10%	.18 3NO, 3NC	.54 4NO, 2NC	.60 5NO, 1NC	R <sub>Coil</sub> Ω ± 10%	.50 2NO, 4NC
AgNi 0,15-contacts + 5 μm Au										
6	4,5 ... 8,4	60	3791	3801	45	3821	3831	3841	38	3851
12	9,0 ... 16,8	240	3792	3802	180	3822	3832	3842	150	3852
24	18,08 ... 33,6	960	3793	3803	720	3823	3833	3843	600	3853
48	36,0 ... 67,2	3840	3794	3804	2880	3824	3834	3844	2425	3854
60	45,0 ... 84,0	6000	3795	3805	4500	3825	3835	3845	3790	3855
110	82,5 ... 154,0	20000	3796	3806	15125	3826	3836	3846	12735	3856

## Ordering Example

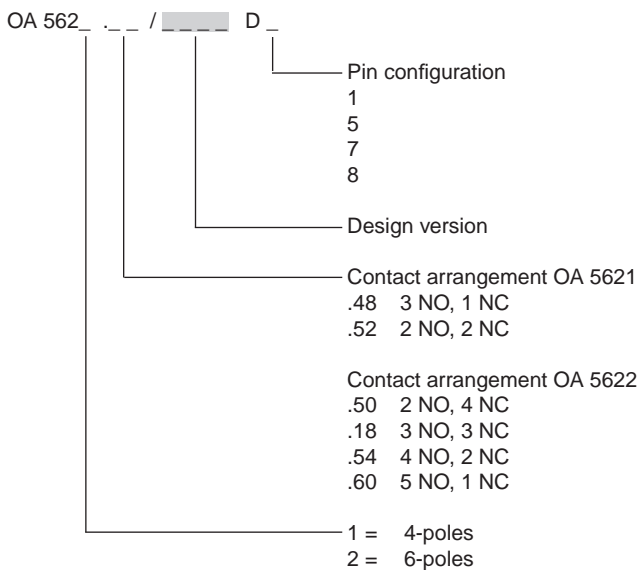

Characteristics

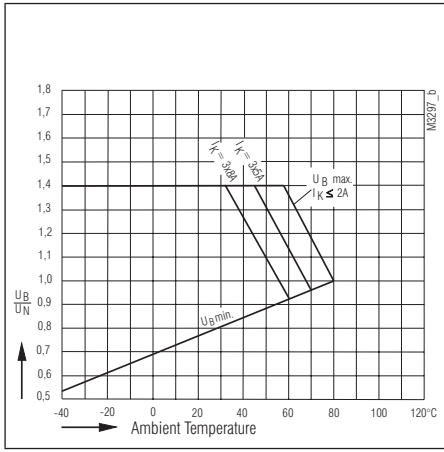

Operating voltage limit curve OA 5621

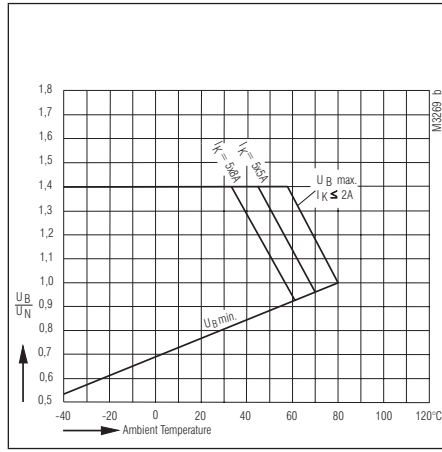

Operating voltage limit curve OA 5622

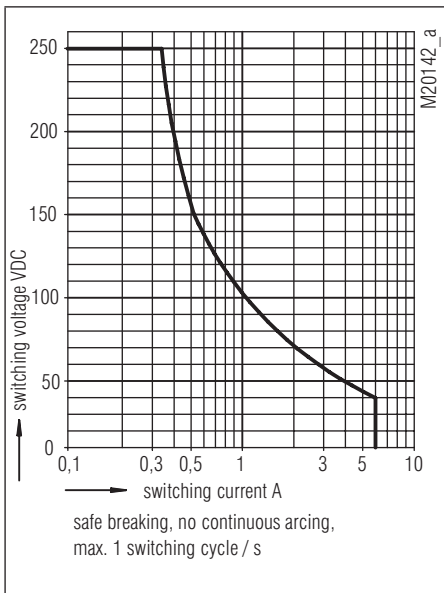

Limit curve for arc-free operation (load limit curve)

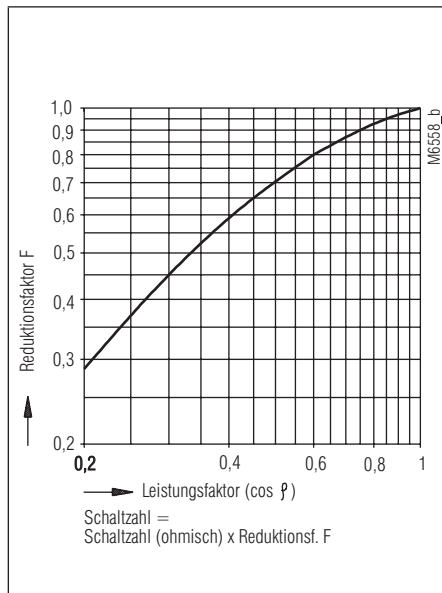

Reduction factor for inductive loads

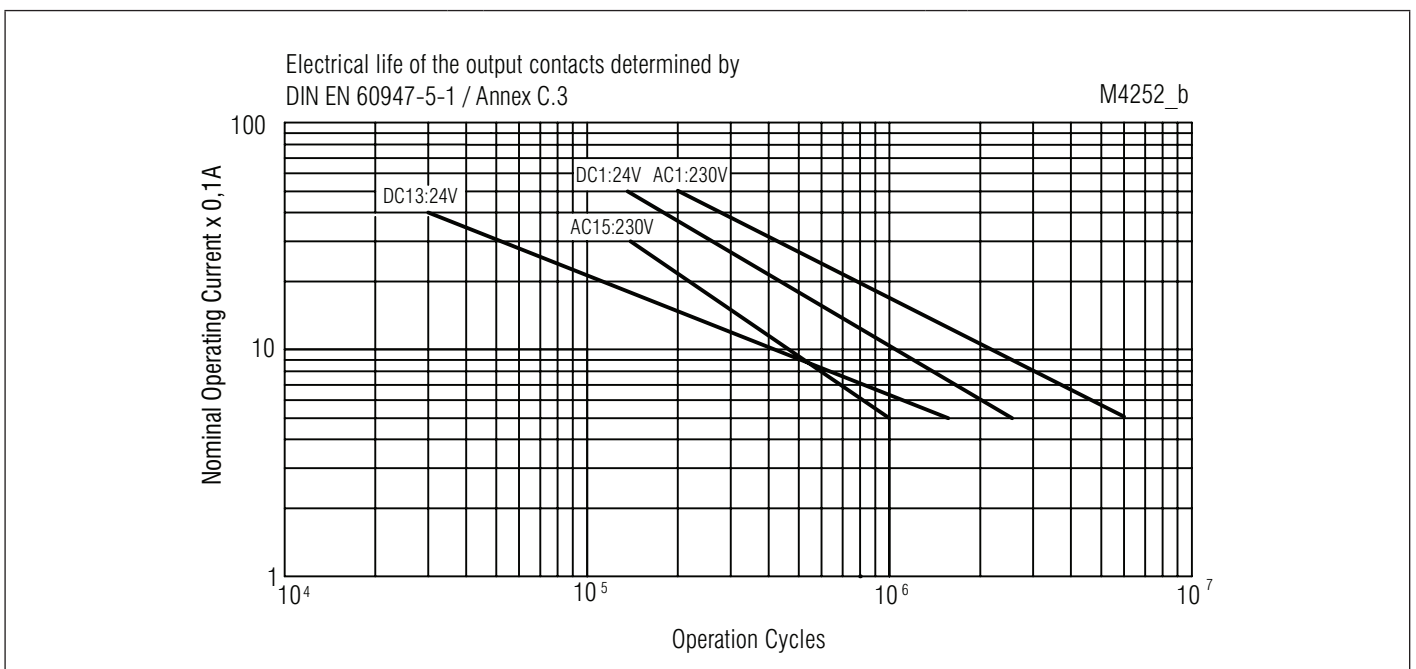

Electrical life

Pin Configurations D1 / D5

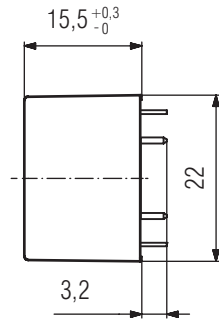
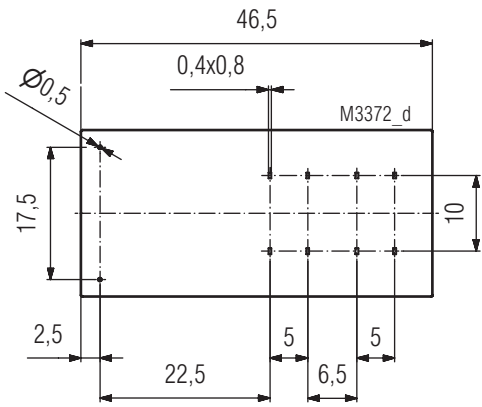

Pin Configuration D1  
Drilling plan (solder side)

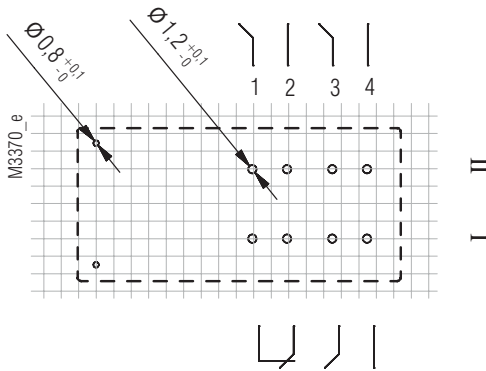

OA5621.48/\_\_\_D1 3NO / 1NC

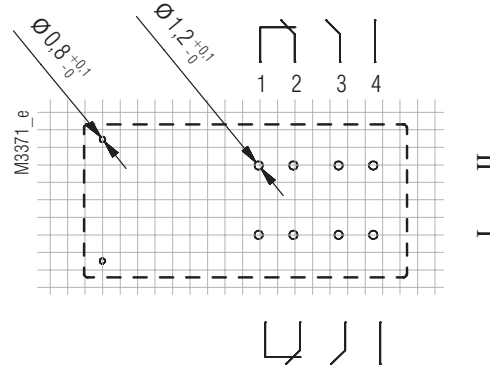

OA5621.52/\_\_\_D1 2NO / 2NC

Pin Configuration D5  
Drilling plan (solder side)

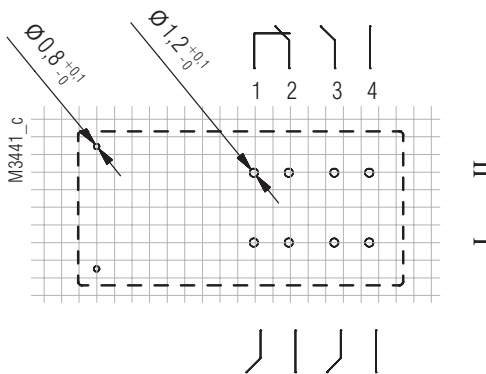

OA5621.48/\_\_\_D5 3NO / 1 NC

Connection for basic grid dimensions 2,50 mm as well as 2,54 mm according to DIN EN 60097, DIN EN 60326

Pin Configurations D7 / D8

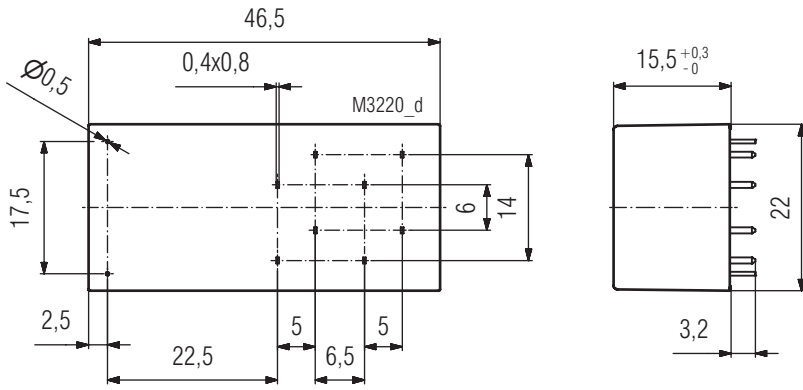

Pin Configuration D7  
Drilling plan (solder side)

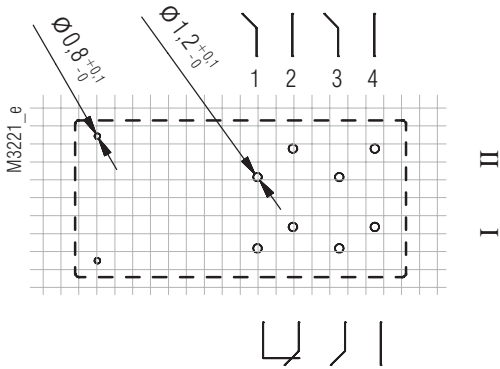

OA5621.48/\_\_\_D7 3NO / 1NC

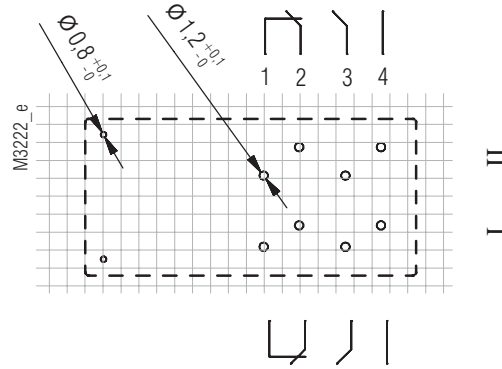

OA5621.52/\_\_\_D7 2NO / 2NC

Pin Configuration D8  
Drilling plan (solder side)

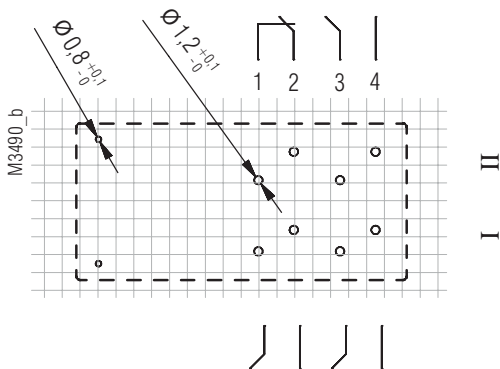

OA5621.48/\_\_\_D8 3NO / 1NC

Connection for basic grid dimensions 2,50 mm as well as 2,54 mm according to DIN EN 60097, DIN EN 60326

Pin Configurations D1 / D5

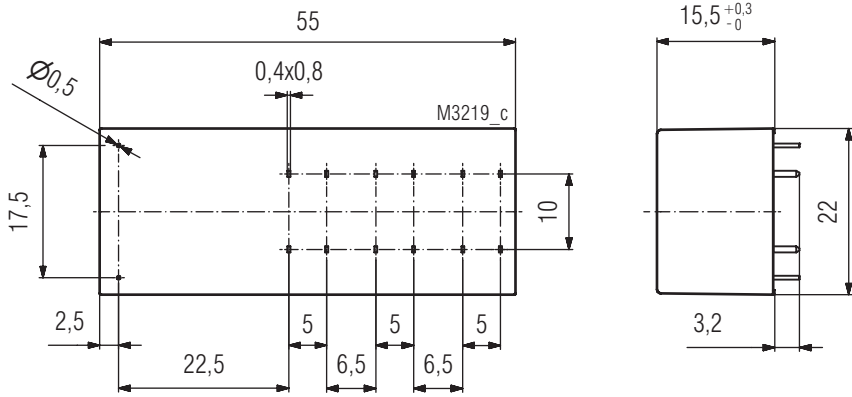

Pin Configuration D1  
Drilling plan (solder side)

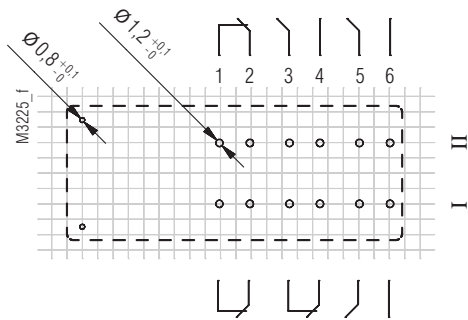

OA 5622.18/\_\_\_D1 3NO / 3NC

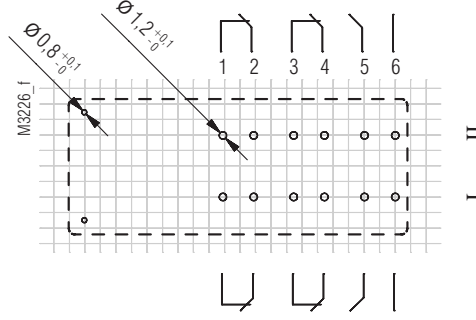

OA 5622.50/\_\_\_D1 2NO / 4NC

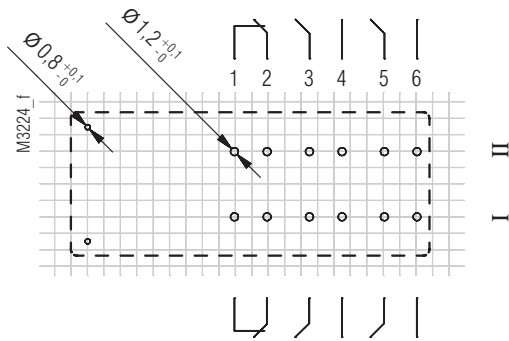

OA 5622.54/\_\_\_D1 4NO / 2NC

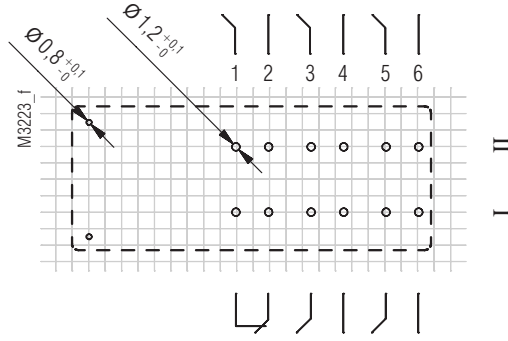

OA 5622.60/\_\_\_D1 5NO / 1NC

Pin Configuration D4  
Drilling plan (solder side)

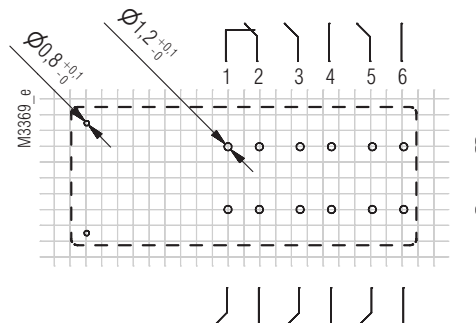

OA 5622.60/\_\_\_D4 5NO / 1NC

Connection for basic grid dimensions 2,50 mm as well as 2,54 mm according to DIN EN 60097, DIN EN 60326



Pin Configuration D7

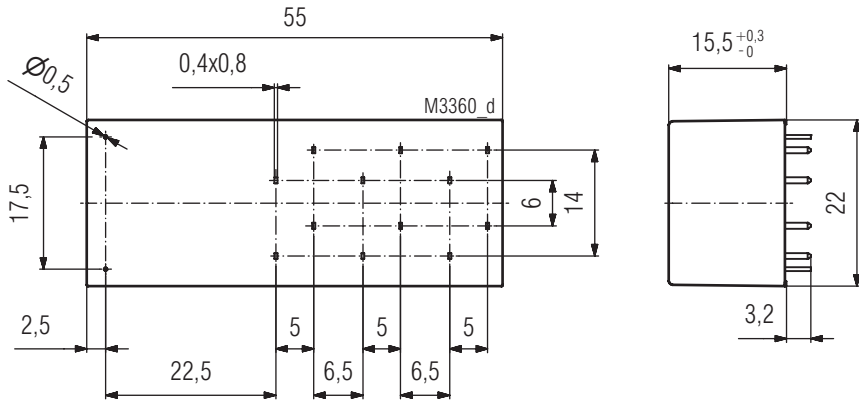

Pin Configuration D7  
Drilling plan (solder side)

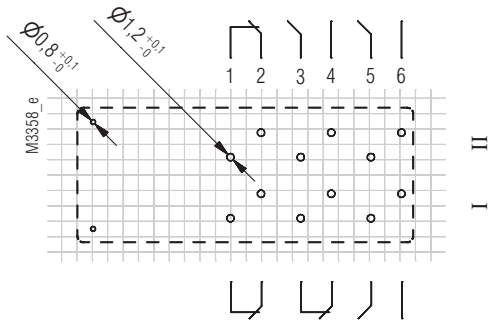

OA 5622.18/\_\_\_D7 3NO / 3NC

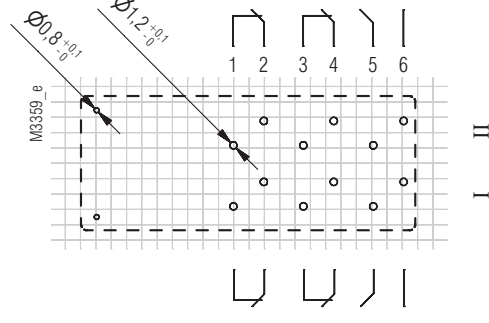

OA 5622.50/\_\_\_D7 2NO / 4NC

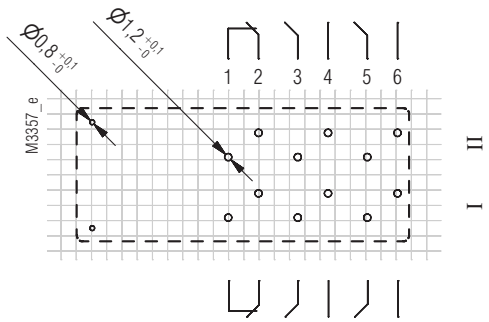

OA 5622.54/\_\_\_D7 4NO / 2NC

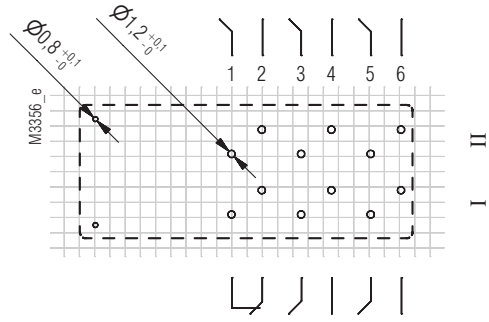

OA 5622.60/\_\_\_D7 5NO / 1NC

Pin Configuration D8  
Drilling plan (solder side)

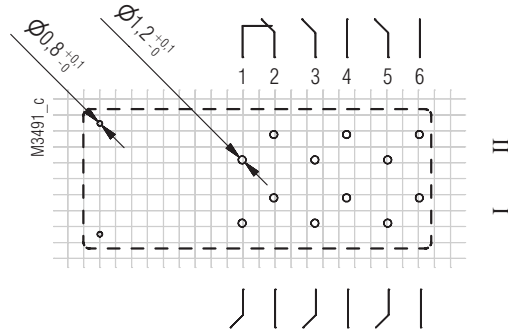

OA 5622.60/\_\_\_D8 5NO / 1NC

Connection for basic grid dimensions 2,50 mm as well as 2,54 mm according to DIN EN 60097, DIN EN 60326

**Notes**

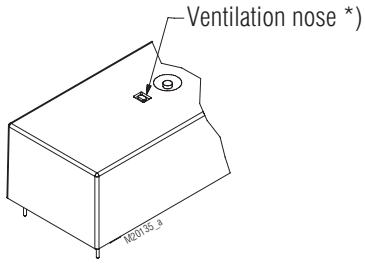

\*) When using the maximum switching capacity it is recommended to open the relay at the indicated position.

**Accessories**

**Socket ET 1415.035**

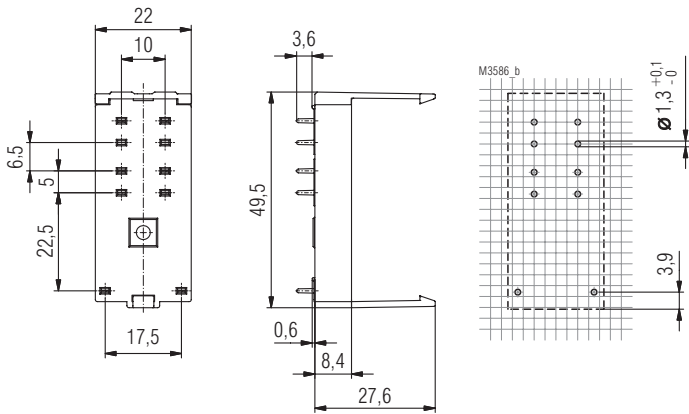

Article number: 0059509

**Socket ET 1415.037**

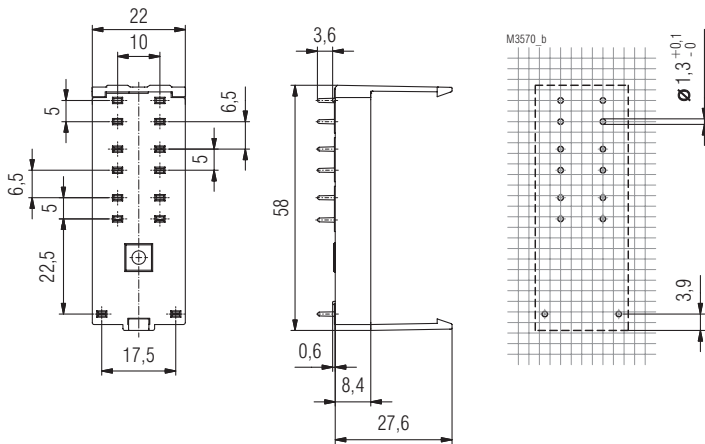

Article number: 0059275

## Relay Bistable OB 5623

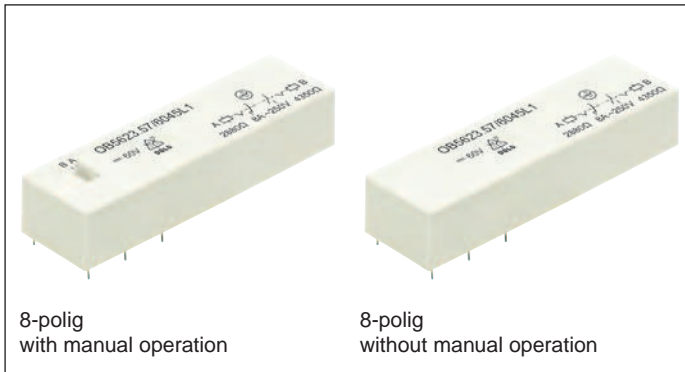

- According to DIN EN 61810-1, DIN EN 61810-3
- With forcibly guided contacts
- Energy efficient; Low energy consumption, because of impulse control, no holding consumption
- Bistable  
Mechanical latching of contact position
- Safe separation between all current circuits
- Both coils non-polarised, neutral
- Defined position when both coils are operated simultaneously
- Impulse operation, duty cycle possible (under fault condition)
- Wide temperature range
- As option with manual operation (mechanical indication)
- Washproof (only without manual operation)
- Height 15.8 mm

### Applications

- Railway and signalling applications
- Automation
- Medical devices
- Radio- and telecontrol applications
- Fuel applications
- Process applications

### Approvals and Markings

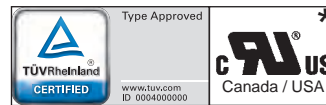

\* in preparation

### Technical Data

Relay type		OB 5623	OB 5623
<b>1.0 Coil</b>		interlocking	unlocking
1.1 Nominal voltage	DC V	6, 12, 24, 48, 60, 110 (others on request)	6; 12; 24; 48; 60, 110 <sup>3)</sup> (others on request)
1.2 Nominal consumption	W	approx. 1.2	approx. 0.7
1.4 Pulse length	ms		≥ 200
1.11 Voltage range	U <sub>N</sub>		0.85 ... 1,2
<b>2.0 Contacts</b>			
2.1 Contact arrangement		4 NO / 4 NC (other on request)	
2.2 Contact material		AgSnO <sub>2</sub> + 0.2 μm Au; AgNi + 0.2 μm Au, AgNi + 5 μm Au	
2.3 Rated insulation voltage	AC V	250	
Switching voltage min./max	V	AC/DC 10 / DC 250, AC 400 (AC/DC 2 V / 60 V) <sup>7)</sup>	
2.4 Limiting continuous current I <sub>th</sub>	A	7 x 8 <sup>8)</sup> (see Operating voltage limit curve)	
Switching current min./max	A	10 mA <sup>6)</sup> / 8 (2 mA / 0,3 A) <sup>7)</sup>	
2.5 Switching power min./max	VA	0.1 <sup>6)</sup> / 2000 (10 mVA / 12 VA) <sup>7)</sup>	
Switching power min./max	W	0.1 <sup>6)</sup> / 200 (10 mW / 12 W) <sup>7)</sup>	
2.6 Switching capacity to IEC/EN 60947-5-1			
AC 15 <sup>9)</sup>	AC V/A	NC: 230 / 3	NO: 230 / 2
AC 15 <sup>2)</sup>	AC V/A	NC: 230 / 5	NO: 230 / 2
DC 13 <sup>9)</sup>	DC V/A	NC: 24 / 2	NO: 24 / 2
2.7 Electrical life		at 1 s On, 4 s Off (see contacts service life)	
at AC 230 V, 8 A, cosφ = 1	switching cycles	> 10 <sup>5</sup> AgNi	
at DC 24 V 8 A ohmic	switching cycles	> 0.75 x 10 <sup>5</sup> AgNi	
2.8 Switching frequency max	switching cycles/s	2	
2.9 Response time <sup>4)</sup> / Release time <sup>5)</sup>	ms	typically 20 / typically 12	
2.10 Contact force	cN	≥ 8	
2.14 Contact gap	mm	1.0 (> 0.5 <sup>1)</sup> )	
<b>3.0 Other</b>			
3.1 Mechanical life	switching cycles	10 x 10 <sup>6</sup>	
3.2 Temperature range	°C	- 40 ... + 75	
3.3 Degree of protection, housing		Solder line proof RT II as option wash proof RT III (without manual operation)	
3.4 Test procedure		A (group mounting)	
3.5 Vibration resistance		10 ... 85 Hz; 0.35 mm amplitude; 4 g max. IEC/EN 60068-2-6	
3.6 Climate resistance		40 / 075 / 04; A / B / D IEC/EN 60068-1	
3.7 Short circuit strength		1 kA / AC 250 V IEC/EN 60947-5-1 <sup>2) 9)</sup>	
SCPD / Fuse		NO contact: 10 A gG/gL / NC contact: 6 A gG/gL IEC/EN 60269-1 <sup>2) 9)</sup>	

<sup>1)</sup> Over entire service life, even when under fault and at 1.1 x U<sub>N</sub>  
<sup>4)</sup> Interlocking  
<sup>7)</sup> Typical values for AgNi-contacts + 5 μm Au

<sup>2)</sup> Values for AgSnO<sub>2</sub>-contacts  
<sup>5)</sup> Unlocking  
<sup>8)</sup> See notes

<sup>3)</sup> Only impulse operation  
<sup>6)</sup> Typical values  
<sup>9)</sup> Values for AgNi-contacts

## Technical Data

3.8	Insulation acc. to IEC 60664-1, EN 50178		OB 5623 (interlocking)	OB 5623 (unlocking)
	Rated insulation voltage	AC V	250	250
	Pollution degree		2	2
	Overvoltage category		III	III
	Test voltage			
	contact-coil (1 min)	AC kV eff.	≥ 4	≥ 4
	contact-contact (1min)	AC kV eff.	≥ 4	≥ 4
	between open contacts	AC kV eff.	≥ 1,5	≥ 1,5
	Transient voltage			
	contact-coil (1.2 - 50 μs)	kV	≥ 6	≥ 6
	Clearance and creepage distance		≥ 5,5	≥ 4,5
3.9	Weight	g	approx. 47	
<b>4.0 Packing unit</b>				
4.1	on cardboard in slipcase	piece	10	
4.2	in case package	piece	100	
<b>5.0 Solder method</b>				
5.1	Solder method /-temperature /-duration	°C / s	Wafer soldering / 260 / 5	

## Ordering Example

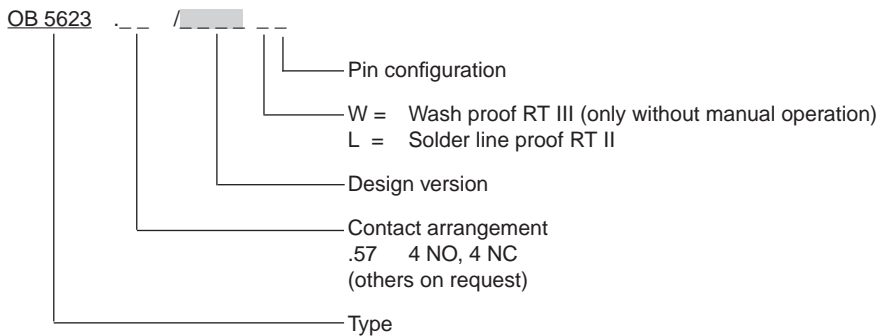

OB 5623 with manual operation				
		interlocking	unlocking	OB 5623
$U_N$ (DCV)	Voltage range (DC V)	$R_{coil}$ at 20° C $\Omega \pm 10\%$	$R_{coil}$ at 20° C $\Omega \pm 10\%$	.57
				4NO, 4NC
AgNi-contacts + 0.2 $\mu$ m Au				
6	5.1 ... 7.2	31	52	6001L
12	10.2 ... 14.4	120	200	6002L
24	20.4 ... 28.8	500	750	6003L
48	40.8 ... 57.6	2000	3600	6004L
60	51.0 ... 72.0	2880	4350	6005L
110 <sup>3)</sup>	93.5 ... 132.0	10100	9216	6006L
AgNi-contacts + 5 $\mu$ m Au (gold plated contacts)				
6	5.1 ... 7.2	31	52	6041L
12	10.2 ... 14.4	120	200	6042L
24	20.4 ... 28.8	500	750	6043L
48	40.8 ... 57.6	2000	3600	6044L
60	51.0 ... 72.0	2880	4350	6045L
110 <sup>3)</sup>	93.5 ... 132.0	10100	9216	6046L
AgSnO <sub>2</sub> -contacts +0.2 $\mu$ m Au				
6	5.1 ... 7.2	31	52	6081L
12	10.2 ... 14.4	120	200	6082L
24	20.4 ... 28.8	500	750	6083L
48	40.8 ... 57.6	2000	3600	6084L
60	51.0 ... 72.0	2880	4350	6085L
110 <sup>3)</sup>	93.5 ... 132.0	10100	9216	6086L

<sup>3)</sup> only impulse operation

OB 5623 without manual operation				
		interlocking	unlocking	OB 5623
$U_N$ (DCV)	Voltage range (DC V)	$R_{coil}$ at 20° C $\Omega \pm 10\%$	$R_{coil}$ at 20° C $\Omega \pm 10\%$	.57
				4NO, 4NC
AgNi-contacts + 0.2 $\mu$ m Au				
6	5.1 ... 7.2	31	52	6121W
12	10.2 ... 14.4	120	200	6122W
24	20.4 ... 28.8	500	750	6123W
48	40.8 ... 57.6	2000	3600	6124W
60	51.0 ... 72.0	2880	4350	6125W
110 <sup>3)</sup>	93.5 ... 132.0	10100	9216	6126W
AgNi-contacts + 5 $\mu$ m Au (gold plated contacts)				
6	5.1 ... 7.2	31	52	6161W
12	10.2 ... 14.4	120	200	6162W
24	20.4 ... 28.8	500	750	6163W
48	40.8 ... 57.6	2000	3600	6164W
60	51.0 ... 72.0	2880	4350	6165W
110 <sup>3)</sup>	93.5 ... 132.0	10100	9216	6166W
AgSnO <sub>2</sub> -contacts + 0.2 $\mu$ m Au				
6	5.1 ... 7.2	31	52	6201W
12	10.2 ... 14.4	120	200	6202W
24	20.4 ... 28.8	500	750	6203W
48	40.8 ... 57.6	2000	3600	6204W
60	51.0 ... 72.0	2880	4350	6205W
110 <sup>3)</sup>	93.5 ... 132.0	10100	9216	6206W

<sup>3)</sup> only impulse operation

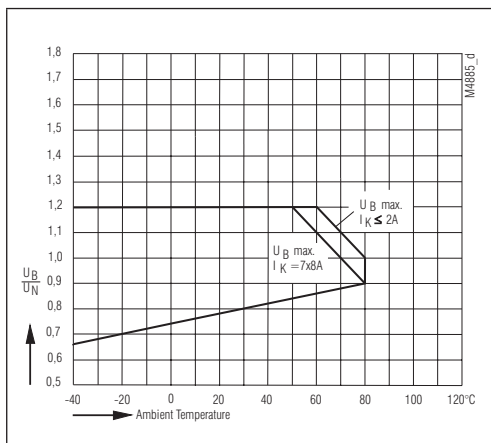

Operating voltage limit curve without influence through self-heating of surrounding components

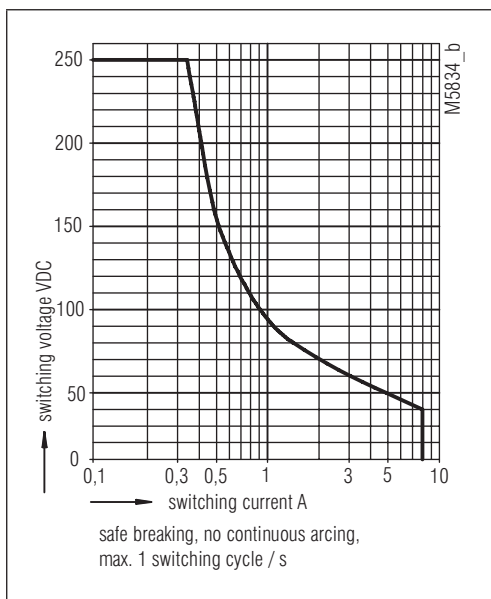

Limit curve for arc-free operation (load limit curve)

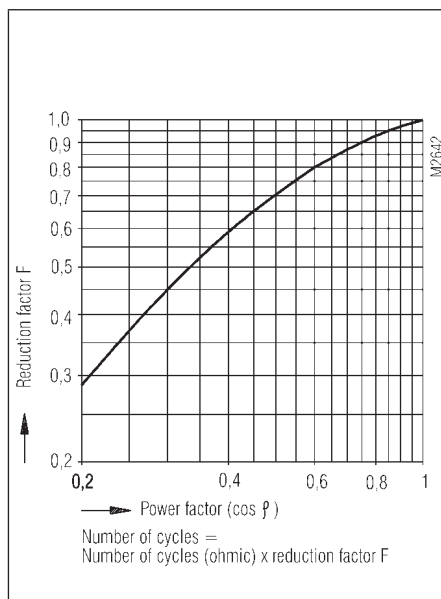

Reduction factor for inductive loads

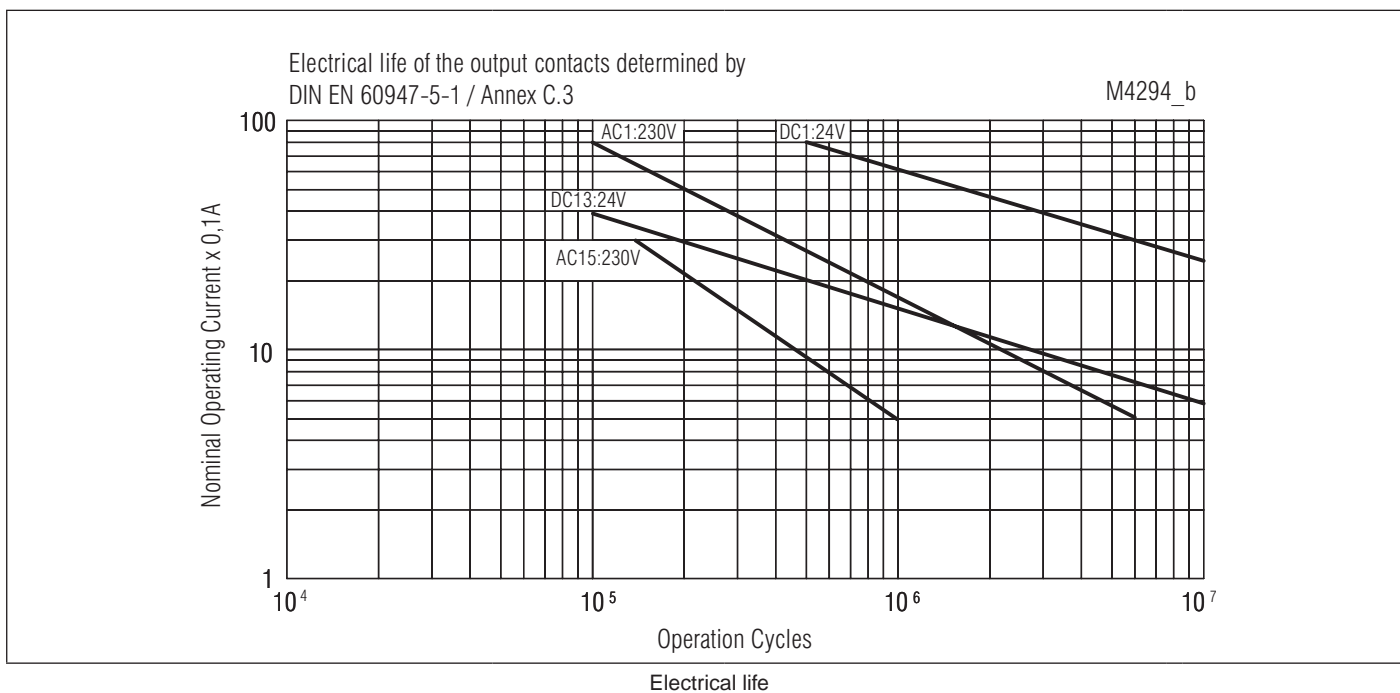

Pin configuration L1 / W1

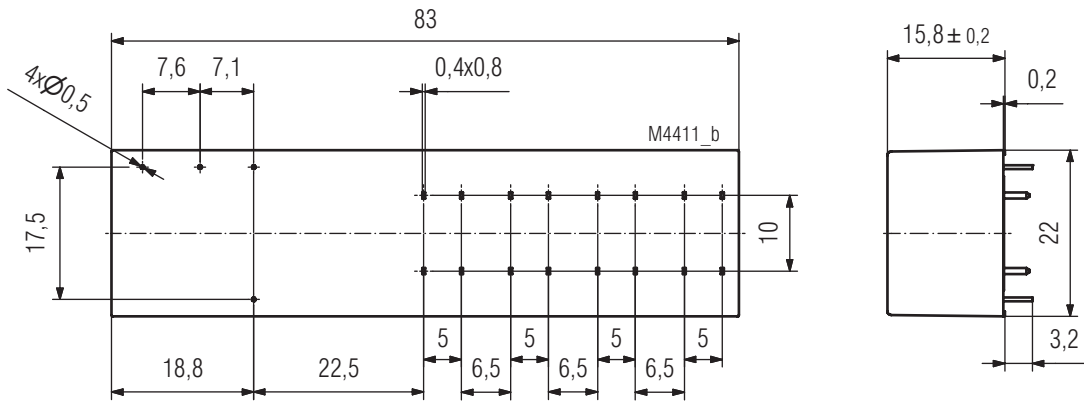

Pin configuration L1 / W1  
Drilling plan (solder side)

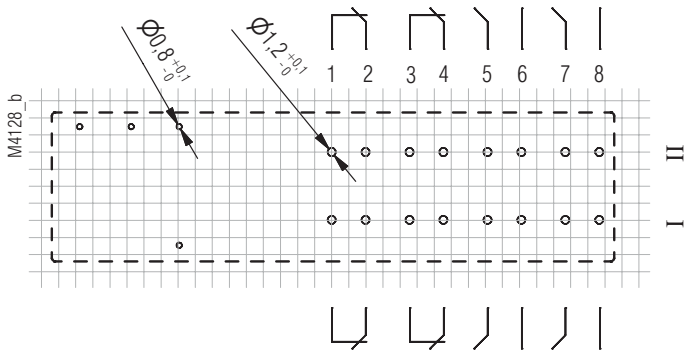

Connection for basic grid dimensions 2.50 mm as well as 2.54 mm according to IEC/EN 60 097, IEC 60 326 average

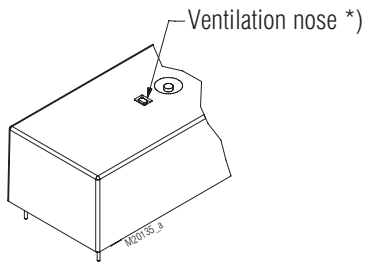

\*) When using the maximum switching capacity it is recommended to open the relay without manual operation at the indicated position.



## Safety Relays

OA 5642, OA 5643, OA 5644

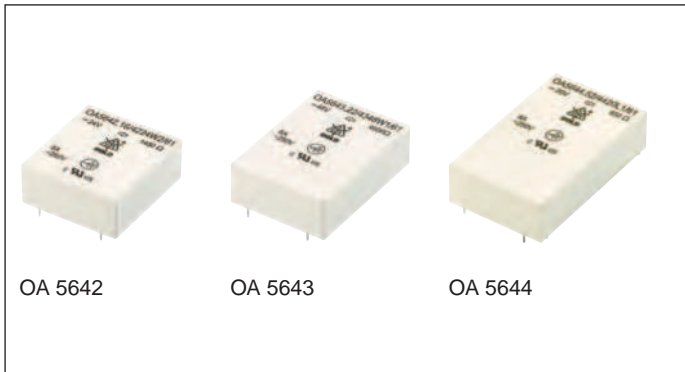

- According to DIN EN 61810-1, DIN EN 61810-3, DIN EN 45545 (fire protection on railway vehicles)
- With forcibly guided contacts
- Safe separation between coil/contact and contact/contact for applications at pollution degree 2 with rated insulation voltage 250 V
- Clearance and creepage distances  
contact - coil  $\geq 5.5$  mm  
contact - contact  $\geq 5.5$  mm
- Low nominal and holding power
- High mechanical service life
- **Extremely smallest height only 10.3 mm and minimum area**
- RoHS compliance
- Placing SMD components between PCB and relay is possible

### Applications

- Switchgear for safety technology
- Press controls
- Escalators and walkways EN 115
- Elevators EN 81-1
- Railway technique

### Approvals and Markings

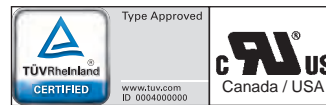

### Technical Data

Relay type		OA 5642	OA 5643	OA 5644
<b>1.0 Relay coil</b>				
1.1 Nominal voltage	DC V	6; 12; 21; 24; 48; 60; 110; others on request		
1.2 Nominal consumption	W	0.40	0.50	0.65
1.11 Voltage range	$U_N$	0.7 ... 1.6	0.7 ... 1.6	0.7 ... 1.6
1.12 Thermal resistance	K/W		$65 \pm 10$	
1.13 Holding power (at 0,5 x $U_N$ )	W	0.1	0.125	0.160
<b>2.0 Contacts</b>				
2.1 Contact arrangement		1 NO / 1 NC	2 NO / 1 NC	2 NO / 2 NC 3 NO / 1 NC
2.2 Contact material		AgSnO <sub>2</sub> + 0.2 $\mu$ m Au; AgNi + 0.2 $\mu$ m Au, AgNi + 5 $\mu$ m Au		
2.3 Rated insulation voltage	AC V	250		
Switching voltage min./max	V	AC 10; DC 10 / DC 250, AC 400 (AC/DC 2 V / AC/DC 60 V) <sup>1)</sup>		
2.4 Limit. contin. current $I_{th}$ max. (each contact)	A	8		
Switching current min./max	A	10 mA <sup>2)</sup> / 8 A (2 mA / 0.3 A) <sup>1)</sup>		
2.5 Switching power min./max.	VA	0,1 <sup>2)</sup> / 2000 (10 mVA / 12 VA) <sup>1)</sup>		
Switching power min./max	W	0,1 <sup>2)</sup> ... 200 (10 mW / 12 W) <sup>1)</sup> (see arc limit curve under resistive load)		
2.6 Switching capacity to IEC/EN 60947-5-1				
AC 15 <sup>3)</sup>	V/A	NO 250 / 3	NC 250 / 1	
AC 15 <sup>4)</sup>	V/A	NO 250 / 5	NC 250 / 2	
DC 13 <sup>3)</sup>	V/A	NO 24 / 2	NC 24 / 2	
DC 13 <sup>3)</sup> at 0,1 Hz	V/A	NO 24 / 4	NC 24 / 4	
to UL 508		B300 / Q300		
2.7 Electrical life				$> 10^5$
at AC 230 V, 8 A, $\cos\phi = 1$	switching cycles	at 1 s On, 1 s Off (see diagram)		
2.8 Switching frequency max.	switching cycles/s	20		
2.9 Response time / Release time	ms	typ. 10 / typ. 5		
2.14 Contact gap	mm	1.0 ... 1.2 ( $> 0.5$ <sup>5)</sup> ) $\hat{=}$ micro contact gab		
<b>3.0 Other</b>				
3.1 Mechanical life	switching cycles	$> 40 \times 10^6$		
3.2 Temperature range	$^{\circ}$ C	- 40 ... + 85		
3.3 Degree of protection		Wash proof RT III		
3.4 Test procedure		A (group mounting)		
3.5 Vibration resistance		10 ... < 60 Hz, a = 0,35 mm IEC/EN 60068-2-6		
Criteria: contact opening $\geq 10$ $\mu$ s		60 ... 200 Hz, 5g (all contacts) IEC/EN 60068-2-6		
3.6 Climate resistance		040 / 085 / 21; A / B / D IEC/EN 60068-1		
3.7 Short circuit strength		1 kA / AC 250 V IEC/EN 60947-5-1 <sup>3)4)</sup>		
SCPD / Fuse		NO contacts: 10 A gG/gL / NC contacts: 6 A gG/gL IEC/EN 60269 <sup>3)4)</sup>		

<sup>1)</sup> Values for AgNi-contacts + 5  $\mu$ m Au

<sup>2)</sup> Typical values for AgNi and AgSnO<sub>2</sub>

<sup>3)</sup> Values for AgNi

<sup>4)</sup> Values for AgSnO<sub>2</sub>

<sup>5)</sup> over entire service life, even when under fault and at 1.6 x  $U_N$

## Technical Data

3.8	Insulation according to IEC 60664-1				
	Rated insulation voltage	AC V		250	
	Pollution degree			2	
	Overvoltage category			III	
	Test voltage				
	Contact- Coil (1 min)	AC kV eff.		≥ 4	
	Contact - Contact (1min)	AC kV eff.		≥ 4	
	between open contacts	AC kV eff.		≥ 1,5	
	Transient voltage				
	Contact- Coil (1,2 - 50 μs)	kV		≥ 6	
	Contact - Contact (1,2 - 50 μs)	kV		≥ 6	
	Clearance and creepage distances				
	Contact- Coil	mm		≥ 5.5	
	Contact - Contact	mm		≥ 5.5	
3.9	Weight	g	approx. 14	approx. 15	approx. 16
<b>4.0 Packing</b>					
4.1	on cardboard in slipcase	piece	32	28	20
4.2	in case package	piece	320	280	200
<b>5.0 Solder method</b>					
5.1	Solder method /-temperature /-duration	°C / s	Wafer soldering / 260 / 5		

## Design Versions

U <sub>N</sub> (DC V)	Voltage range (DC V)	OA 5642		OA 5643		OA 5644		
		R <sub>Coil</sub> Ω±10%	.16 1NO, 1NC	R <sub>Coil</sub> Ω±10%	.22 2NO, 1NC	R <sub>Coil</sub> Ω±10%	.48 3NO, 1NC	.52 2NO, 2NC
AgSnO <sub>2</sub> -contacts + 0,2 μm Au								
6	4.2 ... 9.6	90	4231	70	4331	55	4431	4531
12	8.4 ... 19.2	370	4232	290	4332	230	4432	4532
21	15.0 ... 33.6	1050	4233	840	4333	680	4433	4533
24	16.8 ... 38.4	1450	4234	1150	4334	900	4434	4534
48	33.6 ... 76.8	6000	4235	4600	4335	3600	4435	4535
60	42.0 ... 96.0	9250	4236	7100	4336	5600	4436	4536
110	77.0 ... 176.0	31000	4237	24000	4337	18500	4437	4537
AgNi-contacts + 0.2 μm Au								
6	4.2 ... 9.6	90	4201	70	4301	55	4401	4501
12	8.4 ... 19.2	370	4202	290	4302	230	4402	4502
21	15.0 ... 33.6	1050	4203	840	4303	680	4403	4503
24	16.8 ... 38.4	1450	4204	1150	4304	900	4404	4504
48	33.6 ... 76.8	6000	4205	4600	4305	3600	4405	4505
60	42.0 ... 96.0	9250	4206	7100	4306	5600	4406	4506
110	77.0 ... 176.0	31000	4207	24000	4307	18500	4407	4507
AgNi-contacts + 5 μm Au								
6	4.2 ... 9.6	90	4221	70	4321	55	4421	4521
12	8.4 ... 19.2	370	4222	290	4322	230	4422	4522
21	15.0 ... 33.6	1050	4223	840	4323	680	4423	4523
24	16.8 ... 38.4	1450	4224	1150	4324	900	4424	4524
48	33.6 ... 76.8	6000	4225	4600	4325	3600	4425	4525
60	42.0 ... 96.0	9250	4226	7100	4326	5600	4426	4526
110	77.0 ... 176.0	31000	4227	24000	4327	18500	4427	4527

## Ordering Example

OA 5642... / ... W 1 / 61\*)

Pin configuration

W = wash proof RT III

Design version

Contact arrangement  
.16 1 NO / 1 NC

\*) / 61 cURus approval

**Characteristics**

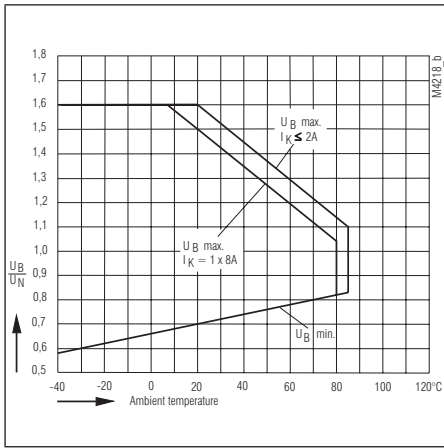

Operating voltage limit curve  
OA 5642.16

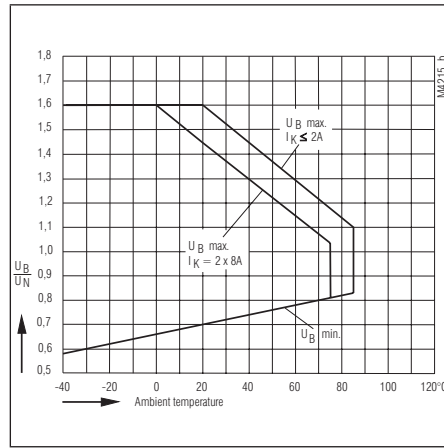

Operating voltage limit curve  
OA 5644.52 und OA 5643.22

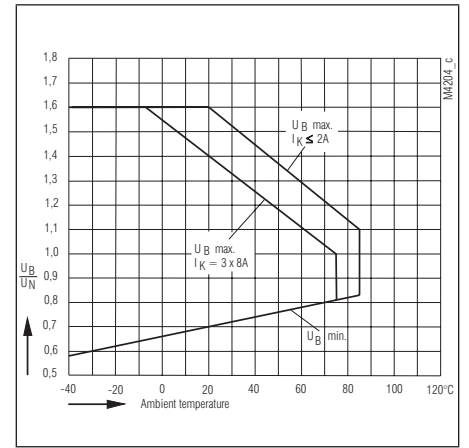

Operating voltage limit curve  
OA 5644.48

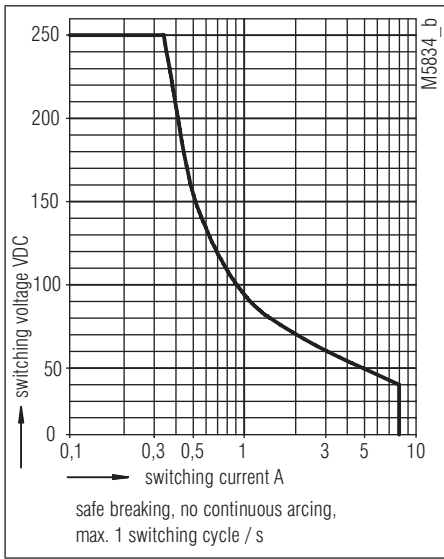

Limit curve for arc-free operat. (load limit curve)

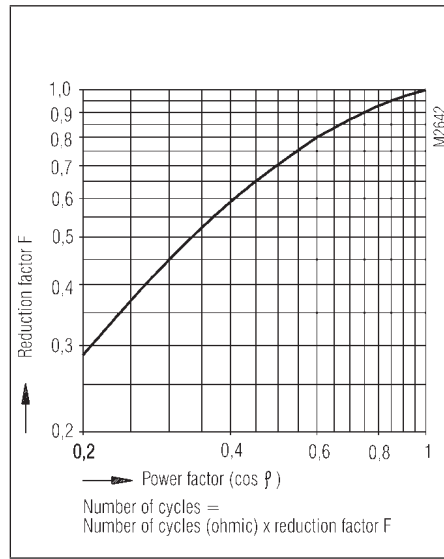

Reduction factor for inductive loads

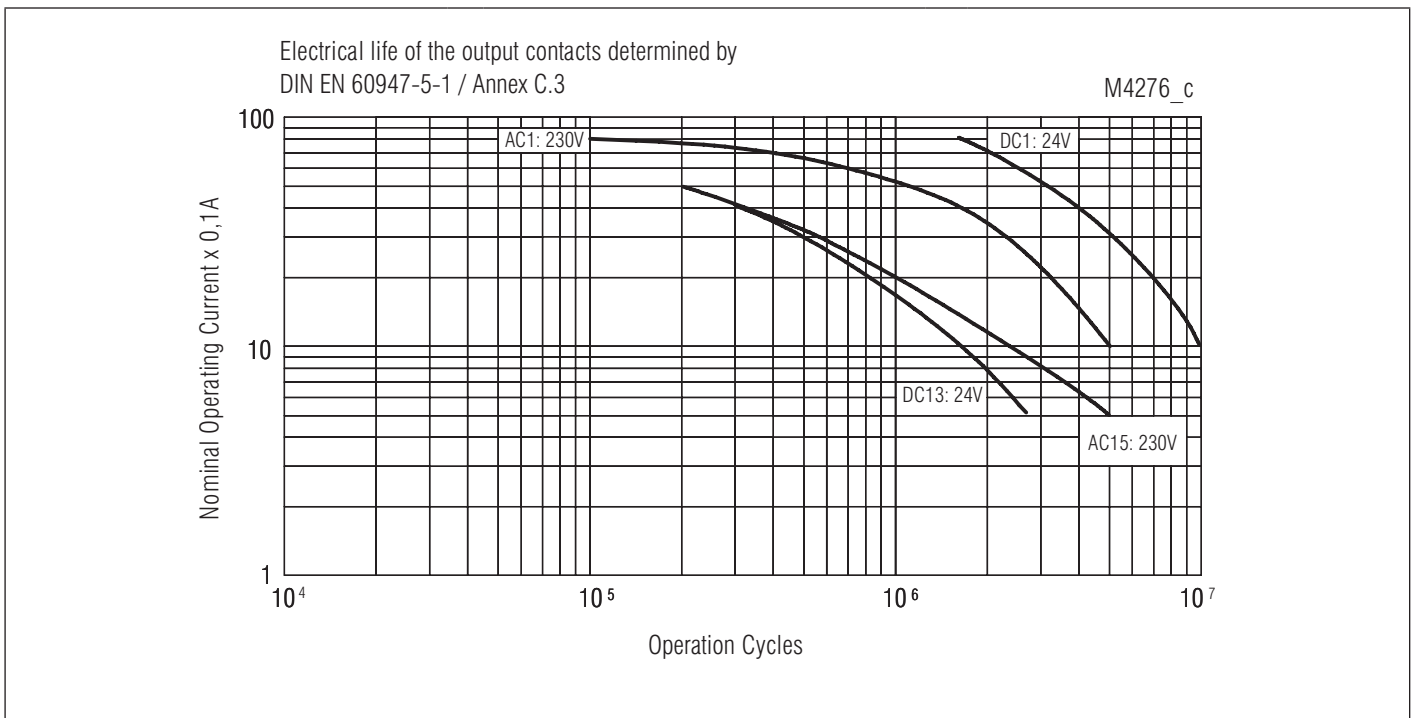

Electrical life of the output contacts determined by  
DIN EN 60947-5-1 / Annex C.3

M4276\_c

Electrical life

## OA 5642 Dimensions, Pin Configuration, Connection Diagrams

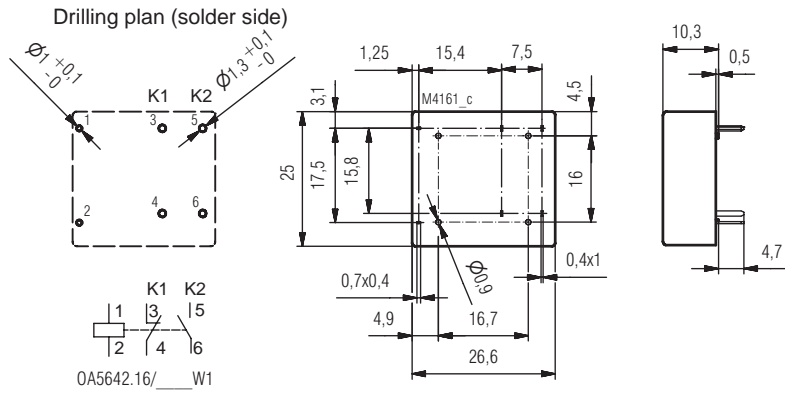

## OA 5643 Dimensions, Pin Configuration, Connection Diagrams

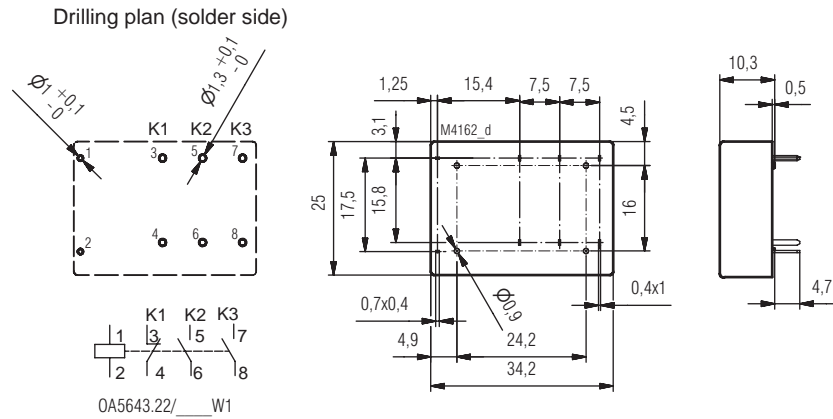

## OA 5644 Dimensions, Pin Configuration, Connection Diagrams

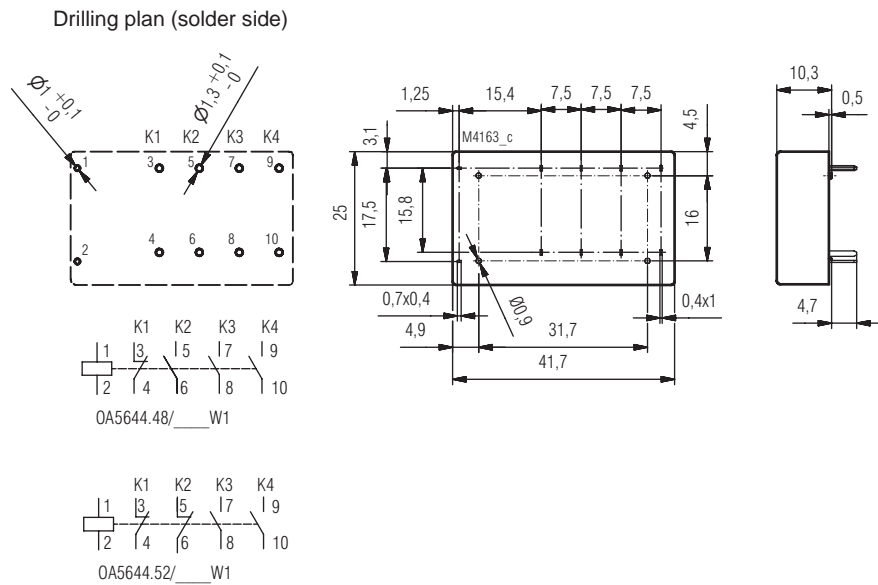

## Notes

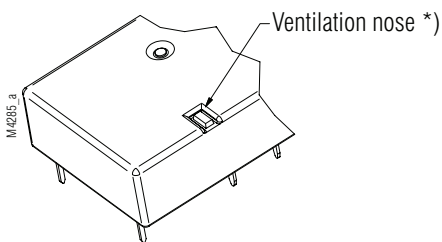

\*) When using the maximum switching capacity it is recommended to open the relay at the indicated position.



- According to DIN EN 61810-1, DIN EN 61810-3
- With forcibly guided contacts
- Clearance and creepage distances:  
contact-coil  $\geq 8$  mm  
**version OA 5667.16 with double and reinforced insulation**
- Low rated power consumption
- High mechanical service life
- Compact size, small height

### Applications

- Switchgear for safety applications
- Press controls

### Approvals and Markings

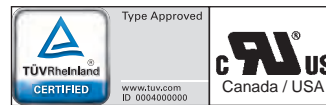

### Technical Data

Relaistyp		OA 5667.12	OA 5667.16
<b>1.0 Relay coil</b>			
1.1 Nominal voltage	DC V	6, 12, 24, 48, 60, 110	
1.2 Nominal consumption	W	0.75	
1.11 Voltage range	$U_N$	0.75 ... 1.3	
1.13 Holding Power (at $0.5 \times U_N$ )	W	0.19	
<b>2.0 Contacts</b>			
2.1 Contact arrangement		2 changeover contacts	1 NO, 1 NC
2.2 Contact material		AgSnO <sub>2</sub> + 0.2 $\mu$ m Au; AgNi + 0.2 $\mu$ m Au, AgNi + 5 $\mu$ m Au	
2.3 Rated insulation voltage	AC V	250	
Switching voltage min./max.	V	AC/DC 10 / DC 250, AC 400 (AC/DC 2 V / 60 V) <sup>1)</sup>	
2.4 Limiting continuous current $I_{th}$	A	2 x 6 (see operating voltage limit curve)	
Switching current min./max.	A	10 mA <sup>3)</sup> / 6 (2 mA / 0.3 A) <sup>1)</sup>	
2.5 Switching power min./max.	VA	0.1 / 1 500 (10 mVA / 12 VA) <sup>1)</sup>	
Switching power min./max.	W	0.1 / 200 (10 mW / 12 W) <sup>1)</sup> (s. limit curve for arc-free operation)	
2.6 Switching capacity to IEC/EN 60947-5-1			
AC 15 <sup>4)</sup>	AC V/A	NO: 250 / 3	NC: 250 / 1
AC 15 <sup>5)</sup>	AC V/A	NO: 250 / 3	NC: 250 / 1
DC 13 <sup>4)</sup>	DC V/A	NO: 24 / 2	NC: 24 / 1
DC 13 <sup>4)</sup> at 0.1 Hz to UL 508	DC V/A	NO: 24 / 4	NC: 24 / 3
		R300	
2.7 Electrical life	switching cycles	at 1 s On, 1 s Off (see contacts service life)	
at AC 230 V, 5 A, $\cos\phi = 1$	switching cycles	$> 10^5$ AgNi 10	$> 1.25 \times 10^5$ AgSnO <sub>2</sub>
2.8 Switching frequency max.	switching cycles/s	10	
2.9 Response time / Release time	ms	typically 10 / typically 6	
2.10 Contact force NO / NC	cN	$\geq 20$ / $\geq 8$	
2.14 Contact gap	mm	$> 0.5$ <sup>2)</sup>	
<b>3.0 Other</b>			
3.1 Mechanical life	switching cycles	$\geq 10^7$	
3.2 Temperature range	$^{\circ}$ C	- 40 ... + 85	
3.3 Degree of protection, housing		Solder line proof RT II	
3.4 Test procedure		A (group mounting)	
3.5 Vibration resistance		10 ... 100 Hz; 0.35 mm amplitude; 4 g max. IEC/EN 60068-2-6	
3.6 Climate resistance		40 / 085 / 04; A/B/D IEC/EN 60068-1	
3.7 Short circuit strength 1 kA / AC 250 V	AgNi or AgSnO <sub>2</sub>	6 AgL	IEC/EN 60947-5-1

<sup>1)</sup> Values for AgNi-contacts + 5  $\mu$ m Au

<sup>4)</sup> Values for AgNi-contacts

<sup>2)</sup> over entire service life, even when under fault and at  $1.3 \times U_N$

<sup>5)</sup> Values for AgSnO<sub>2</sub>-contacts

<sup>3)</sup> Typical values

## Technical Data

3.8	Insulation acc. to IEC 60664-1, EN 50178		OA 5667.12	OA 5667.16
	Rated insulation voltage	AC V	250	250
	Pollution degree		3	3
	Overtoltage category		III	III
	Test voltage			
	Contact-coil (1 min)	AC kV eff.	≥ 4	≥ 4
	Contact-contact (1min)	AC kV eff.	≥ 2.5	≥ 4
	Open contact acc.to DIN EN 61810-1	AC kV eff.	1.5	1.5
	Transient voltage			
	Contact-coil (1.2 - 50 μs)	kV	≥ 6	≥ 6
	Clearance and creepage distances			
	Contact-coil	mm	≥ 8	≥ 8
	Contact-contact	mm	≥ 4.5	≥ 8
3.9	Weight	g	approx. 17	
<b>4.0 Packing</b>				
4.1	on cardboard	piece	24	
4.2	in case package	piece	240	
<b>5.0 Solder method</b>				
5.1	Solder method /-temperature /-duration	°C / s	Wafer soldering / 260 / 5	

## Design Versions

U <sub>N</sub> DC V	Voltage range (DC V)	Resistance at 20°C	AgSnO <sub>2</sub> -contacts + 0,2 μm Au		AgNi10-contacts + 0,2 μm Au		AgNi10-contacts + 5 μm Au	
			OA 5667.12 2 C/O	OA 5667.16 1 NO / 1 NC	OA 5667.12 2 C/O	OA 5667.16 1 NO / 1 NC	OA 5667.12 2 C/O	OA 5667.16 1 NO / 1 NC
6	4.5 ... 7.8	48	2801	2831	2811	2841	2821	2851
12	9.0 ... 15.6	183	2802	2832	2812	2842	2822	2852
24	18.0 ... 31.2	750	2803	2833	2813	2843	2823	2853
48	36.0 ... 62.4	3 200	2804	2834	2814	2844	2824	2854
60	45.0 ... 78.0	4 700	2805	2835	2815	2845	2825	2855
110	82.5 ... 143.5	15 300	2806	2836	2816	2846	2826	2856

## Ordering Example

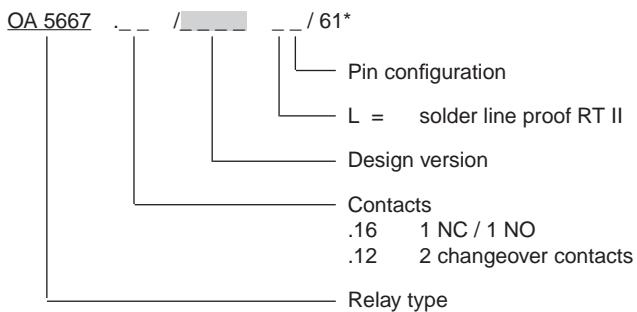

\* /61 cURus approval

# Characteristics

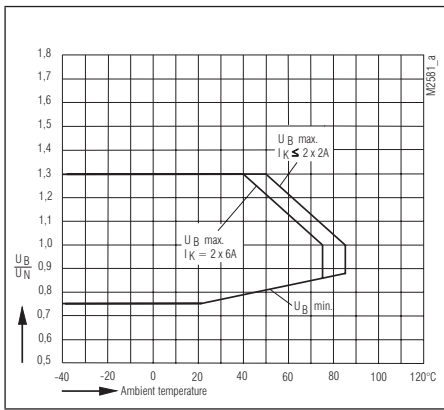

Operating voltage limit curve

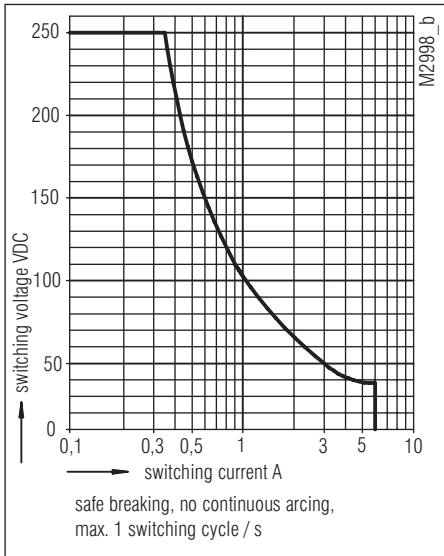

Limit curve for arc-free operation

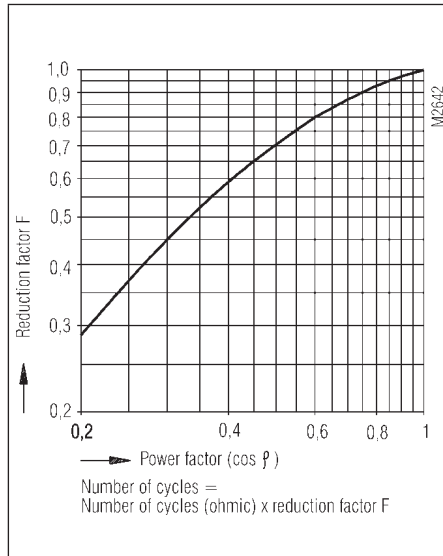

Reduction factor for inductive loads

Electrical life of the output contacts determined by  
DIN EN 60947-5-1 / Annex C.3

M4727\_a

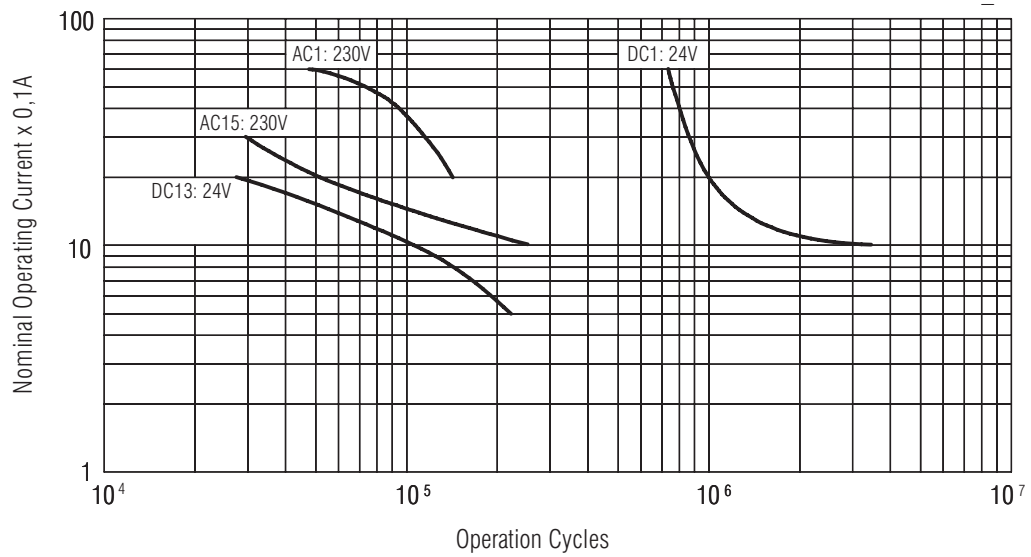

Electrical life

Drilling plan (solder side)

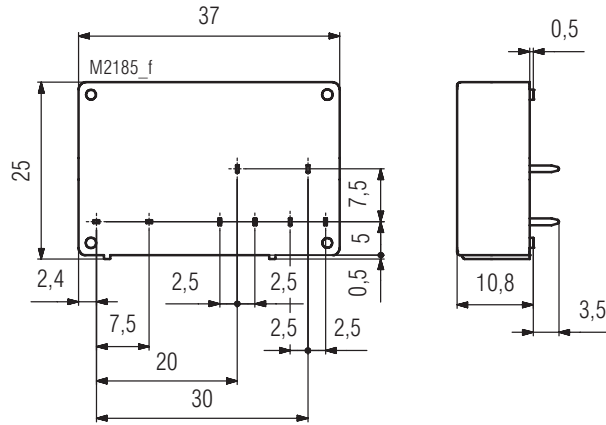
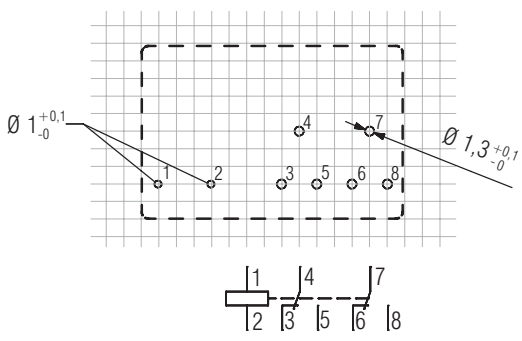

OA 5667.12/...L1  
 OA 5667.20/...L1 contact 6 not fitted

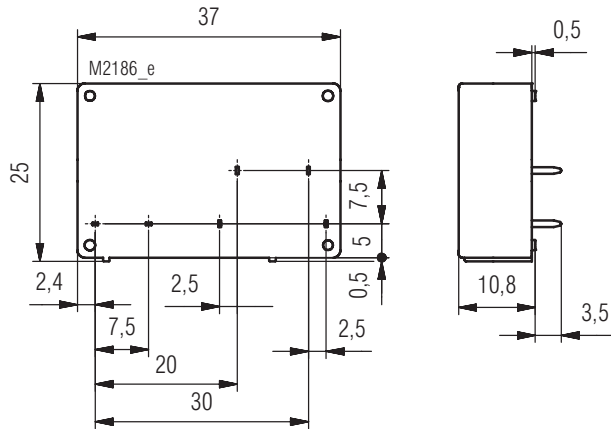
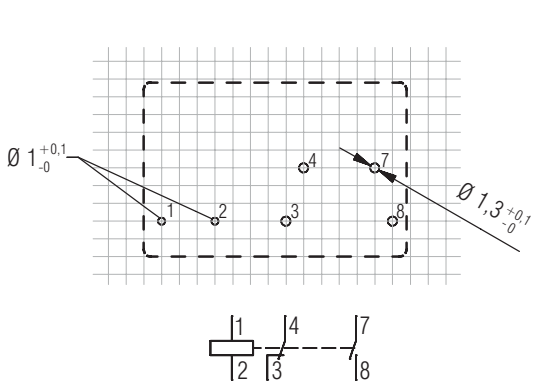

OA 5667.16/...L1

Connection for basic grid dimensions 2.5 mm as well as 2.54 mm according to IEC/EN 60097 and IEC 60326 average



## Safety relay

OA 5667/ \_ \_ \_ \_ 4



- According to DIN EN 61810-1, DIN EN 61810-3
- With forcibly guided contacts
- Clearance and creepage distances:  
contact - coil  $\geq 8$  mm  
contact - contact  $\geq 5,5$  mm  
**Double and reinforced insulation between contacts**
- Low rated power consumption
- High voltage resistance  $\geq 4$  kV at pollution degree 2
- High mechanical service life
- Compact size, small height

### Applications

- Switchgear for safety technology
- Press controls

### Approvals and Markings

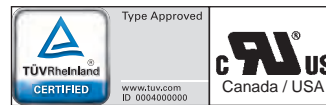

### Technical Data

Relay type		OA 5667._ _ / _ _ _ _ 4	
<b>1.0 Relay coil</b>			
1.1 Nominal voltage	DC V	6, 12, 24, 48, 60, 110	
1.2 Nominal consumption	W	0.75	
1.11 Voltage range	$U_N$	0.75 ... 1.3	
1.13 Holding Power (at 0.5 x $U_N$ )	W	0.19	
<b>2.0 Contacts</b>			
2.1 Contact arrangement		2 changeover contacts / 1 NO, 1 NC	
2.2 Contact material		AgSnO <sub>2</sub> + 0.2 $\mu$ m Au; AgNi + 0.2 $\mu$ m Au, AgNi + 5 $\mu$ m Au	
2.3 Rated insulation voltage	AC V	250	
Switching voltage min./max.	V	AC/DC 10 / DC 250, AC 400 (AC/DC 2 V / 60 V) <sup>1)</sup>	
2.4 Limiting continuous current $I_{th}$	A	2 x 6 (see operating voltage limit curve)	
Switching current min./max.	A	10 mA <sup>3)</sup> / 6 (2 mA / 0.3 A) <sup>1)</sup>	
2.5 Switching power min./max.	VA	0.1 / 1 500 (10 mVA / 12 VA) <sup>1)</sup>	
Switching power min./max.	W	0.1 / 200 (10 mW / 12 W) <sup>1)</sup> (see limit curve for arc-free operation)	
2.6 Switching capacity to IEC/EN 60947-5-1			
AC 15 <sup>4)</sup>	AC V/A	NO: 250 / 3	NC: 250 / 1
AC 15 <sup>5)</sup>	AC V/A	NO: 250 / 3	NC: 250 / 1
DC 13 <sup>4)</sup>	DC V/A	NO: 24 / 2	NC: 24 / 1
DC 13 <sup>4)</sup> at 0.1 Hz to UL 508	DC V/A	NO: 24 / 4	NC: 24 / 3
		R300	
2.7 Electrical life	switching cycles	at 1 s On, 1 s Off (see contacts service life)	
at AC 250 V, 6 A, $\cos\phi = 1$	switching cycles	> 10 <sup>5</sup> AgNi 10	> 1.25 x 10 <sup>5</sup> AgSnO <sub>2</sub>
2.8 Switching frequency max.	switching cycles / s	10	
2.9 Response time / Release time	ms	typically 10 / typically 6	
2.10 Contact force NO / NC	cN	$\geq 20$ / $\geq 8$	
2.14 Contact gap	mm	> 0,5 <sup>2)</sup>	
<b>3.0 Other</b>			
3.1 Mechanical life	switching cycles	$\geq 10^7$	
3.2 Temperature range	°C	- 40 ... + 85	
3.3 Degree of protection, housing		Solder line proof RT II	
3.4 Test procedure		A (group mounting)	
3.5 Vibration resistance		10 ... 100 Hz; 0.35 mm Amplitude; 4 g max. IEC/EN 60068-2-6	
3.6 Climate resistance		40 / 085 / 04; A/B/D IEC/EN 60068-1	
3.7 Short circuit strength 1 kA / AC 250 V	AgNi or AgSnO <sub>2</sub>	6 AgL IEC/EN 60947-5-1	

<sup>1)</sup> Values for AgNi 10-contacts + 5  $\mu$ m Au

<sup>2)</sup> over entire service life, even when under fault and at 1,3 x  $U_N$

<sup>3)</sup> Typical values

<sup>4)</sup> Values for AgNi-contacts

<sup>5)</sup> Values for AgSnO<sub>2</sub>-contacts

## Technical Data

3.8	Insulation acc. to IEC 60664-1, EN 50178		<b>double and reinforced insulation</b>
	Rated insulation voltage	AC V	250
	Pollution degree		2
	Overtoltage category		III
	Test voltage		
	Contact-coil (1 min)	AC kV eff.	≥ 4
	Contact-contact (1min)	AC kV eff.	≥ 4
	Open contact acc. to DIN EN 61810-1	AC kV eff.	1.5
	Transient voltage		
	Contact-coil (1.2 - 50 μs)	kV	≥ 6
	Clearance and creepage distances		
	Contact-coil	mm	≥ 8
	Contact-contact	mm	≥ 5.5
3.9	Weight	g	approx. 17
<b>4.0 Packing</b>			
4.1	on cardboard	piece	24
4.2	in case package	piece	240
<b>5.0 Solder method</b>			
5.1	Solder method /-temperature /-duration	°C / s	Wafer soldering / 260 / 5

## Design Versions

U <sub>N</sub> (DC V)	Voltage range (DC V)	Resistance at 20°C	AgNi10-contacts + 0,2 μm Au		AgNi10-contacts + 5 μm Au	
			OA 5667.12 2 C/O	OA 5667.16 1NO, 1NC	OA 5667.12 2 C/O	OA 5667.16 1NO, 1NC
6	4.5 ... 7.8	48	2861	2891	2871	2901
12	9.0 ... 15.6	183	2862	2892	2872	2902
24	18.0 ... 31.2	750	2863	2893	2873	2903
48	36.0 ... 62.4	3200	2864	2894	2874	2904
60	45.0 ... 78.0	4700	2865	2895	2875	2905
110	82.5 ... 143.5	15300	2866	2896	2876	2906

## Ordering Example

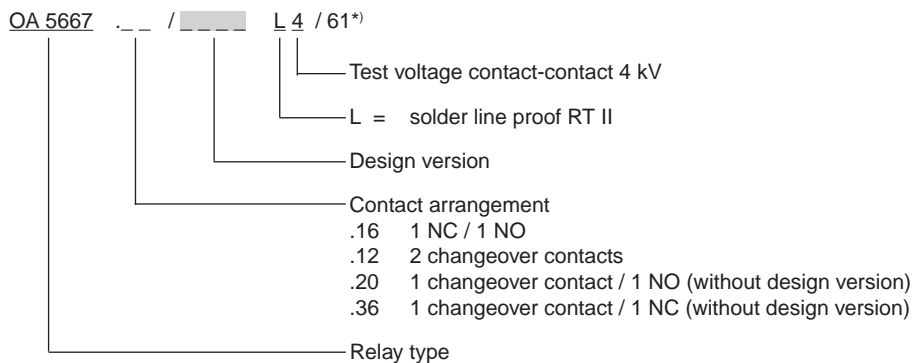

\*) /61 cURus approval

Characteristics

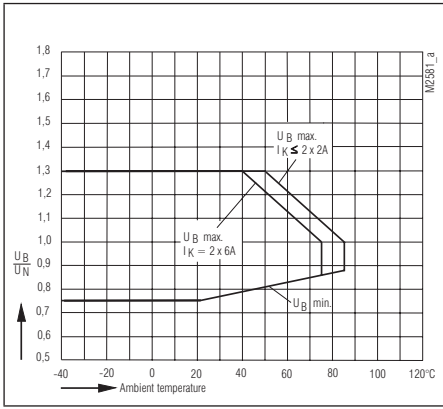

Operating voltage limit curve

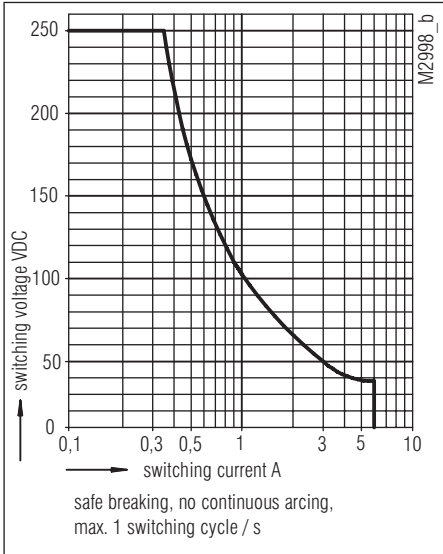

Limit curve for arc-free operation

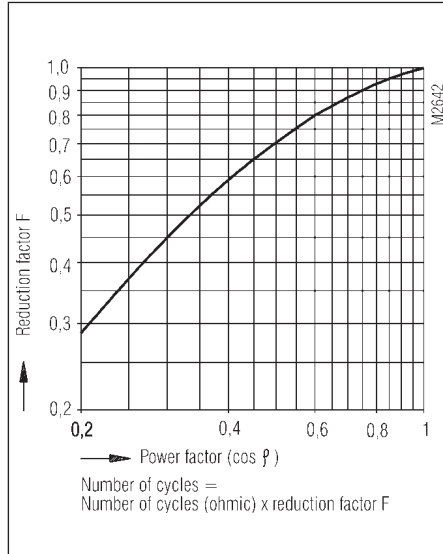

Reduction factor for inductive loads

Electrical life of the output contacts determined by  
DIN EN 60947-5-1 / Annex C.3

M4727\_a

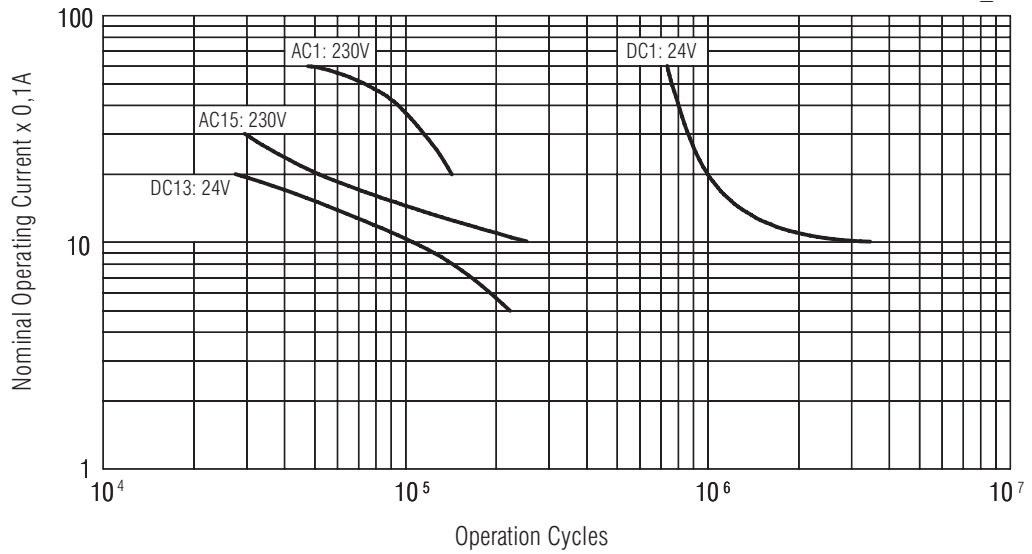

Electrical life

Drilling plan (solder side)

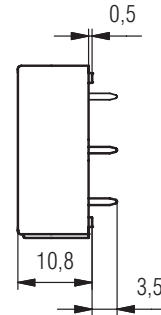
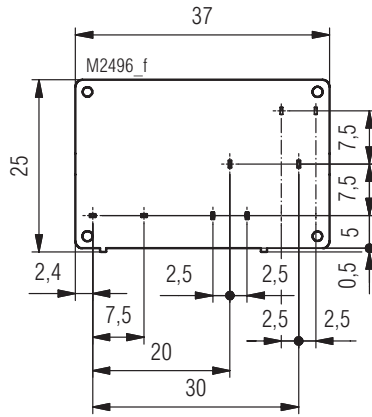
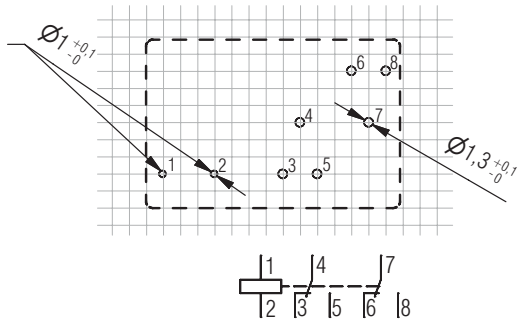

OA 5667.12/...L4  
 OA 5667.20/...L4 contact 6 not fitted

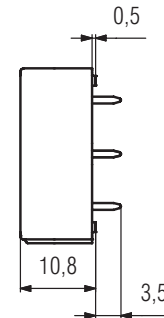
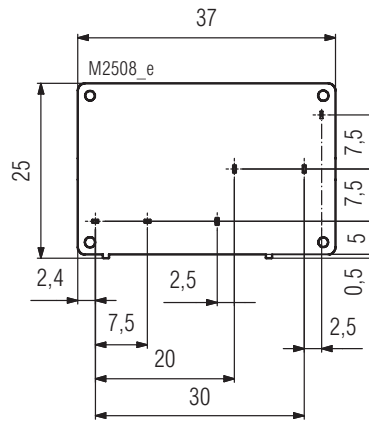
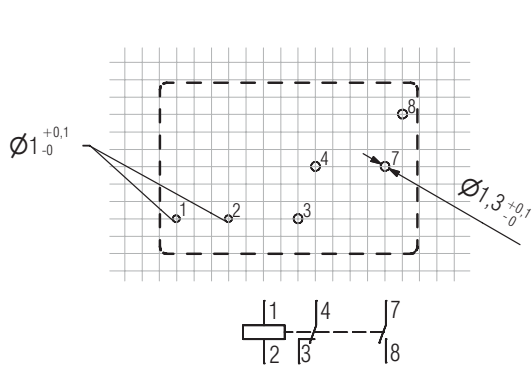

OA 5667.16/...L4

Connection for basic grid dimensions 2.5 mm as well as 2.54 mm according to IEC/EN 60097 and IEC 60326 average

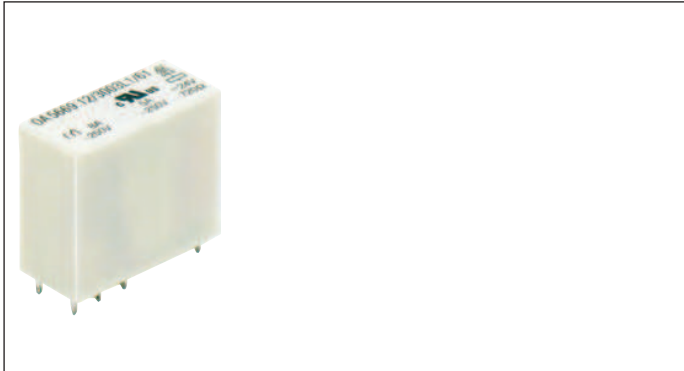

- According to DIN EN 61810-1, DIN EN 61810-3
- With forcibly guided contacts
- Clearance and creepage distances  
contact-coil  $\geq 8$  mm,  
contact - contact  $\geq 5.5$  mm
- **Double and reinforced insulation between contact sets**
- Low rated power consumption
- High mechanical service life
- Compact size, small height
- Wash proof model as option

**Application**

- Switchgear for safety technology
- Escalators and walkways
- Elevators for men and load
- Press controls
- Railway technology

**Approvals and Markings**

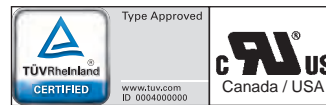

**Technical Data**

Relay type		OA/OW 5669	
<b>1.0 Relay coil</b>			
1.1 Nominal voltage	DC V	6, 12, 20, 24, 48, 60, 110 (other on request)	
1.2 Nominal consumption	W	0.7	
1.11 Voltage range	$U_N$	0.8 ... 1.6	
1.3 Holding power (at $0.5 \times U_N$ )	W	0.18	
<b>2.0 Contacts</b>			
2.1 Contact arrangement		1 NC / 1NO 2 changeover contacts	
2.2 Contact material		AgSnO <sub>2</sub> + 0.2 $\mu$ m Au; AgNi + 0.2 $\mu$ m Au, AgNi + 5 $\mu$ m Au	
2.3 Rated insulation voltage	AC V	250	
Switching voltage min./max.	V	AC/DC 10 / DC 250, AC 400 (AC/DC 2 V / 60 V) <sup>1)</sup>	
2.4 Limiting continuous current $I_{th}$	A	2 x 5 (see operating voltage limit curve)	
Switching current min./max.	A	10 mA <sup>3)</sup> / 8 (2 mA / 0.3 A) <sup>1)</sup>	
2.5 Switching power min./max.	VA	0,1 / 2000 (10 mVA / 12 VA) <sup>1)</sup>	
Switching power min./max.	W	0,1 <sup>3)</sup> / 200 (10 mW / 12 W) <sup>1)</sup> (see limit curve for arc-free operation)	
2.6 Switching capacity to IEC/EN 60947-5-1		R300	
AC 15 <sup>4)</sup>	AC V/A	NO: 250 / 2	NC: 250 / 1
AC 15 <sup>5)</sup>	AC V/A	NO: 250 / 3	NC: 250 / 2
DC 13 <sup>4)</sup>	DC V/A	NO: 24 / 2	NC: 24 / 1
DC 13 <sup>4)</sup> at 0.1 Hz	DC V/A	NO: 24 / 4	NC: 24 / 4
to UL 508			
2.7 Electrical life <sup>2)</sup>		at 1 s On, 1 s Off (see contacts service life)	
AC 230 V 6 A $\cos \varphi = 1$	switching cycles	$> 2 \times 10^5$ AgSnO <sub>2</sub>	$> 2 \times 10^5$ AgNi
2.8 Switching frequency max.	switching cycles / s	10	
2.9 Response time / Release time	ms	$\leq 15$ / $\leq 12$	
2.10 Contact force	cN	$\geq 10$ / $\geq 8$	
<b>3.0 Other</b>			
3.1 Mechanical life	switching cycles	$\geq 50 \times 10^6$	
3.2 Temperature range	$^{\circ}$ C	- 40 ... + 70 mounted without distance ( $I_{th} = 2 \times 5$ A)	
3.3 Degree of protection		Solder line proof RT II as option wash proof RT III	
3.4 Test procedure		A (group mounting)	
3.5 Vibration resistance		10 ... 200 Hz; NC 2 g; NO 10 g; IEC/EN 60068-2-6	
3.6 Climate resistance		40 / 070 / 04; A / B / D IEC/EN 60068-1	
3.7 Short circuit strength 1 kA / AC 250 V	AgSnO <sub>2</sub> AgNi	10 A gL IEC/EN 60947-5-1 6 A gL IEC/EN 60947-5-1	

<sup>1)</sup> Values for AgNi-contacts + 5  $\mu$ m Au

<sup>2)</sup> 10 A total current at  $t = 20^{\circ}$ C and coil voltage  $U_N$

<sup>3)</sup> Typical values for AgSnO<sub>2</sub> and AgNi

<sup>4)</sup> Values for AgNi-contacts

<sup>5)</sup> Values for AgSnO<sub>2</sub>-contacts

## Technical Data

3.8	Insulation acc. to IEC 60664-1, EN 50178		<b>double and reinforced insulation</b>
	Rated insulation voltage	AC V	250
	Pollution degree		2
	Overvoltage category		III
	Test voltage		
	Contact-coil (1 min)	AC kV eff.	≥ 4
	Contact-contact (1min)	AC kV eff.	≥ 4
	Open contact acc. to DIN EN 61810-1	AC kV eff.	1.5
	Transient voltage		
	Contact-coil (1.2 - 50 μs)	kV	≥ 6
	Clearance and creepage distances		
	Contact-coil	mm	≥ 8
	Contact-contact	mm	≥ 5.5
3.9	Weight	g	approx. 19
<b>4.0 Packing</b>			
4.1	on cardboard in slipcase	piece	56
4.2	in case package	piece	280
<b>5.0 Solder method</b>			
5.1	Solder method /-temperature /-duration	°C / s	Wafer soldering / 260 / 5

## Design versions

U <sub>N</sub> DC V	Voltage range V	Resistance Ω (± 10%)	AgNi - contacts + 0.2 μm Au			AgNi - contacts + 5 μm Au		AgSnO <sub>2</sub> - contacts + 0.2 μm Au	
			OA5669.12	OA5669.16		OA5669.12	OA5669.16	OA5669.12	OA5669.16
6	4.8 ... 9.6	50	981	992	462	691	771	581	
12	9.6 ... 19.2	210	982	993	463	692	772	582	553
20	16.0 ... 32.0	580	987	998	468	697	777	587	558
24	19.2 ... 38.4	820	983	994	464	693	773	583	554
48	38.4 ... 76.8	3200	984	995	465	694	774	584	555
60	48.0 ... 96.0	5200	985	996	466	695	775	585	556
110	88.0 ... 176.0	18000	986	997	467	696	776	586	557
				1)	2)		1)		1)

1) = Pin configuration standard

2) = Pin configuration reverse

## Ordering example

O\_ 5669.\_ \_ / \_ \_ / 61\*)

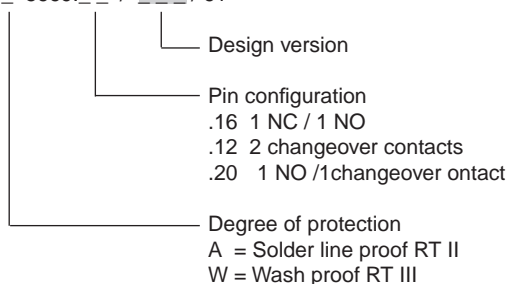

\*) /61 cURus approval

**Characteristics**

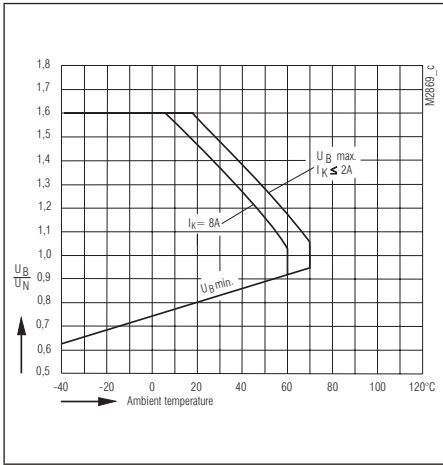

Operating voltage limit curve

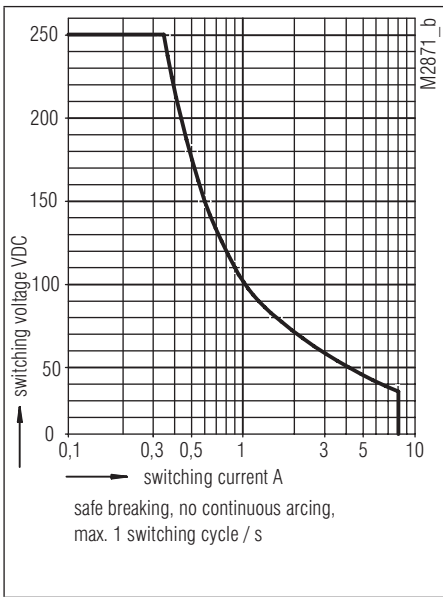

Limit curve for arc-free operation (at  $t_u = 20^\circ\text{C}$ )  
Contact material AgNi

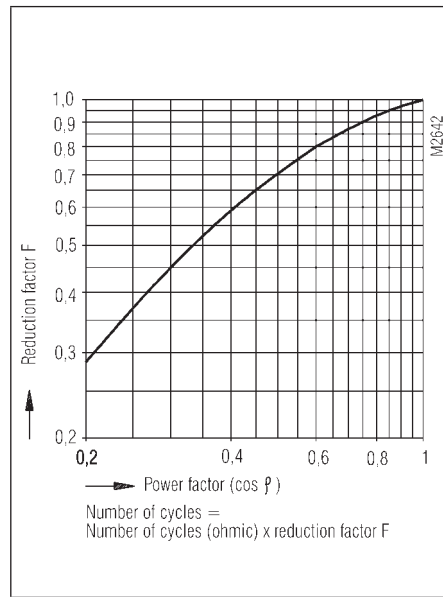

Reduction factor for reactive loads

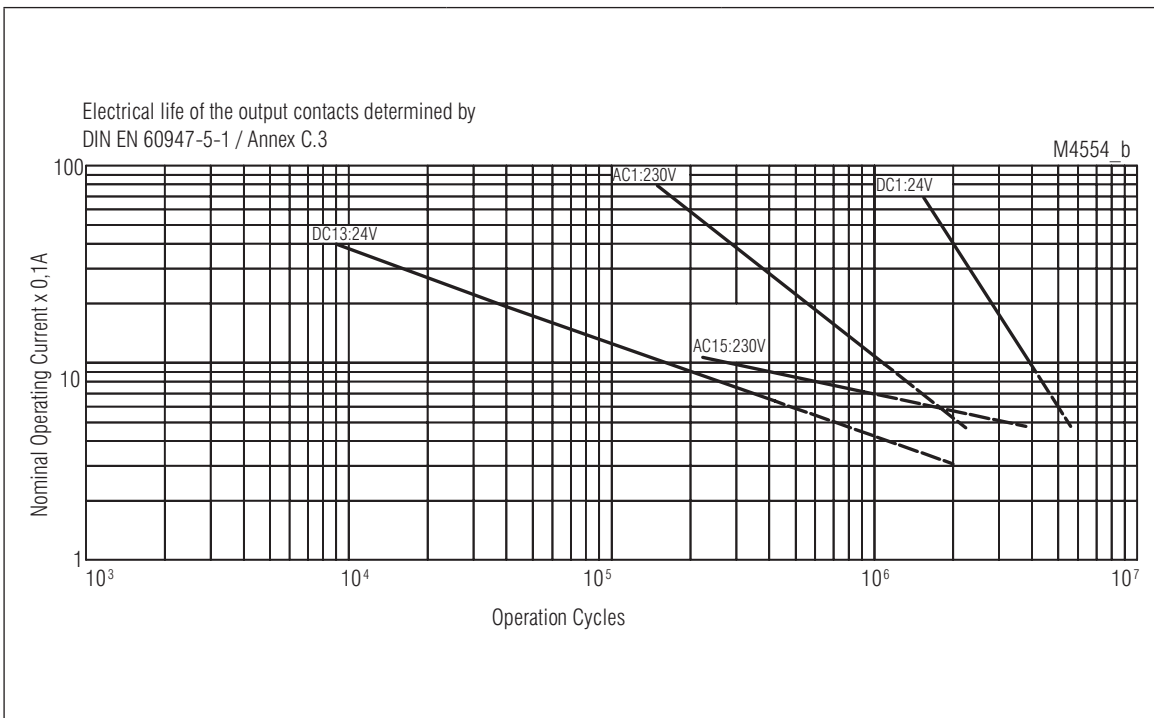

Electrical life for contact material AgNi

Drilling plan (solder side)

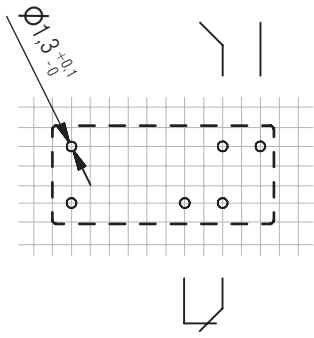

Pin configuration standard

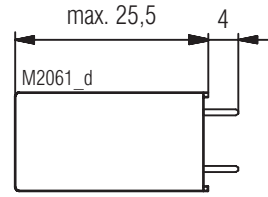
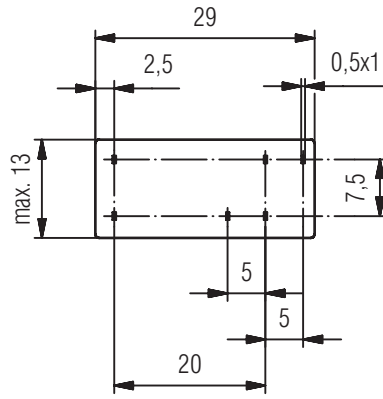

OA5669.16  
OW5669.16

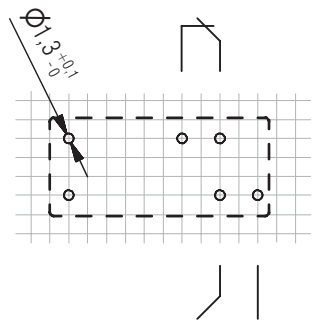

Pin configuration reverse

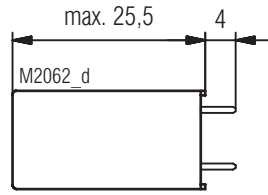
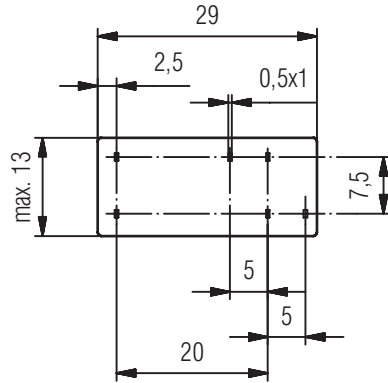

OA5669.16  
OW5669.16

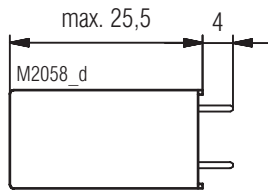
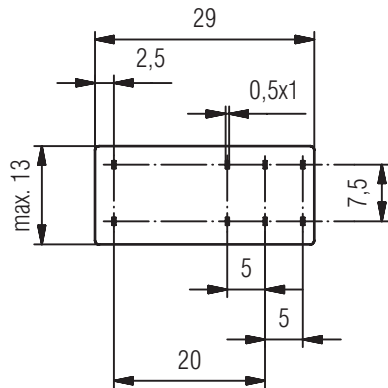
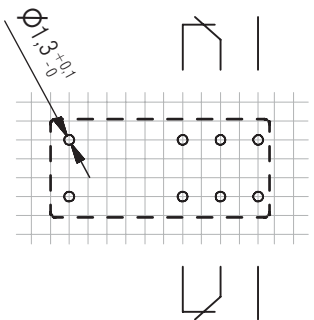

OA5668.12  
OW5668.12  
  
OA5669.12  
OW5669.12

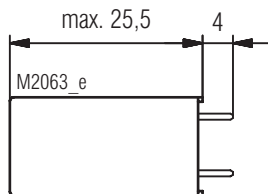
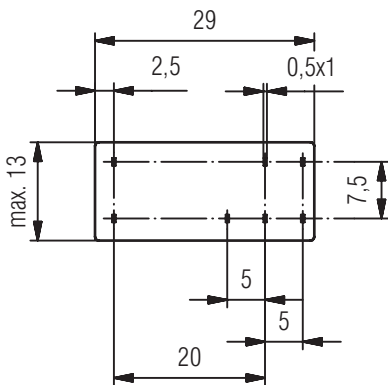
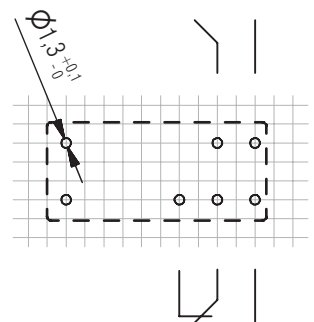

OA5669.20  
OW5669.20

Connection for basic grid dimensions 2.5 mm as well as 2.54 mm according to IEC/EN 60097 and IEC 60326 average



Drilling plan (solder side)

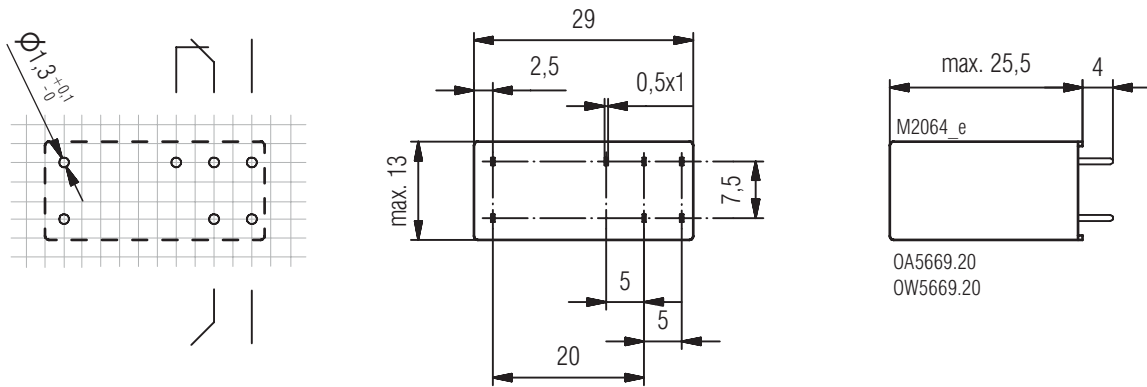

Connection for basic grid dimensions 2.5 mm as well as 2.54 mm according to IEC/EN 60097 and IEC 60326 average

Accessories

Socket ET 1415.021 Fixing clip ET 1415.025	Socket ET 1415.041	Socket ET 1415.044	Socket ET 1415.047
	<ul style="list-style-type: none"> <li>• Socket for DIN-rail</li> <li>• incl. fixing clip</li> </ul>	<ul style="list-style-type: none"> <li>• Socket for DIN-rail</li> <li>• incl. fixing clip</li> </ul>	
Article number: 0034769	Article number: 0055571	Article number: 0059274	Article number: 0059270
	wire connection solid / stranded: 0.14 ... 2.5 mm <sup>2</sup> (14 - 20 AWG) wire connection with sleeved end: 0.14 ... 1.5 mm <sup>2</sup> (14 - 25 AWG)	wire connection solid / stranded: 0.14 ... 2.5 mm <sup>2</sup> (14 - 20 AWG) wire connection with sleeved end: 0.14 ... 1.5 mm <sup>2</sup> (14 - 25 AWG)	wire connection solid / stranded / sleeved end: 2 x (0.2 ... 1.5) mm <sup>2</sup> (16 - 25 AWG)
Fixing clip (wire): 0034770 Fixing clip (plastic): 0047726	<b>Function modules</b> <b>ET1415.913:</b> DC 24 V, with free-wheel diode and green LED Article number: 0056828 <b>ET1415.911:</b> DC 24 V, with free-wheel diode and red LED Article number: 0055909 <b>ET1415.924:</b> DC 60 V, with free-wheel diode and red LED Article number: 0062552 <b>ET1415.912:</b> AC/DC 24 V, with varistor and green LED Article number: 0055910		

## Safety relay

OA 5669. \_ \_ /3 \_ \_ \_



- According to DIN EN 61810-1, DIN EN 61810-3
- Clearance and creepage distances:  
contact - coil  $\geq 8$  mm,  
contact - contact  $\geq 5.5$  mm  
**double and reinforced insulation between contact sets**
- Low rated power consumption
- High mechanical service life
- For high ambient temperature up to  $+85^{\circ}\text{C}$
- Compact size, small height
- As option wash proof RT III

### Applications

- Switchgear for safety technology
- Press controls

### Approvals and Markings

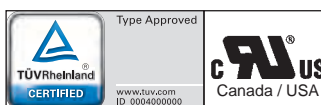

### Technical Data

Relaistyp		OA 5669
<b>1.0 Relay coil</b>		
1.1 Nominal voltage	DC V	6; 12; 24; 48; 60; 110 (others on request)
1.2 Nominal consumption	W	0.8
1.11 Voltage range	$U_N$	0.75 ... 1.4
1.13 Holding Power (at $0.5 \times U_N$ )	W	0.2
<b>2.0 Contacts</b>		
2.1 Contact arrangements		2 changeover contacts, 1 NC and 1 NO
2.2 Contact material		AgSnO <sub>2</sub> + 0.2 $\mu\text{m}$ Au; AgNi + 0.2 $\mu\text{m}$ Au, AgNi + 5 $\mu\text{m}$ Au
2.3 Rated insulation voltage	AC V	250
Switching voltage min./max.	V	AC/DC 10 / DC 250, AC 400 (AC/DC 2 V / 60 V) <sup>1)</sup>
2.4 Limiting continuous current $I_{th}$	A	2 x 5 (see operating voltage limit curve)
Switching current min./max.	A	10 mA <sup>3)</sup> / 8 (2 mA / 0.3 A) <sup>1)</sup>
2.5 Switching power min./max.	VA	0.1 / 2000 (10 mVA / 12 VA) <sup>1)</sup>
Switching power min./max.	W	0.1 <sup>3)</sup> / 200 (10 mW / 12 W) <sup>1)</sup> (s. limit curve for arc-free operation)
2.6 Switching capacity to IEC/EN 60947-5-1		
AC 15 <sup>4)</sup>	AC V/A	NO: 250 / 2 NC: 250 / 1
AC 15 <sup>5)</sup>	AC V/A	NO: 250 / 3 NC: 250 / 2
DC 13 <sup>4)</sup>	DC V/A	NO: 24 / 1 NC: 24 / 1
DC 13 <sup>4)</sup> at 0.1 Hz	DC V/A	NO: 24 / 4 NC: 24 / 4
to UL 508		R300
2.7 Electrical life	switching cycles	at 1 s On, 1 s Off (see contacts service life)
at AC 230 V, 6 A, $\cos\phi = 1$	switching cycles	$> 2 \times 10^5$ AgNi $> 2 \times 10^5$ AgSnO <sub>2</sub>
2.8 max. switching frequency	switching cycles/s	10
2.9 Response time / Release time	ms	$\leq 15$ / $\leq 12$
2.10 Contact force NO / NC	cN	$\geq 13$ / $\geq 10$
<b>3.0 Other</b>		
3.1 Mechanical life	switching cycles	$\geq 50 \times 10^6$
3.2 Temperature range	$^{\circ}\text{C}$	- 40 ... + 85 mounted without distance ( $I_{th} = 2 \times 5$ A)
3.3 Degree of protection		Solder line proof RT II as option wash proof RT III
3.4 Test procedure		A (group mounting)
3.5 Vibration resistance		10 ... 200 Hz; NC 2 g; NO 10 g; IEC/EN 60068-2-6
3.6 Climate resistance		40 / 085 / 04; A/B/D IEC/EN 60068-1
3.7 Short circuit strength 1 kA / AC 250 V	AgSnO <sub>2</sub> AgNi	10 A gL IEC/EN 60947-5-1 6 A gL IEC/EN 60947-5-1

1) Values for AgNi-contacts + 5  $\mu\text{m}$  Au

2) 10 A total current at  $t = 20^{\circ}\text{C}$  and coil voltage =  $U_N$

3) Typical values for AgSnO<sub>2</sub> and AgNi

4) Values for AgNi-contacts

5) Values for AgSnO<sub>2</sub>-contacts

## Technical Data

3.8	Insulation acc. to IEC 60664-1, EN 50178		<b>double and reinforced insulation</b>
	Rated insulation voltage	AC V	250
	Pollution degree		2
	Overtoltage category		III
	Test voltage		
	Contact-coil (1 min)	AC kV eff.	≥ 4
	Contact-contact (1min)	AC kV eff.	≥ 4
	Open contact acc. to DIN EN 61810-1	AC kV eff.	1.5
	Transient voltage		
	Contact-coil (1.2 - 50 μs)	kV	≥ 6
	Clearance and creepage distances		
	Contact-coil	mm	≥ 8
	Contact-contact	mm	≥ 5.5
3.9	Weight	g	approx. 19
<b>4.0 Packing</b>			
4.1	on cardboard	piece	56
4.2	in case package	piece	280
<b>5.0 Solder method</b>			
5.1	Solder method /-temperature /-duration	°C / s	Wafer soldering / 260 / 5

## Design Versions

U <sub>N</sub> (DC V)	Voltage range (DC V)	Resistance at 20°C	AgNi-contacts + 0,2 μm Au		
			OA 5669.12	OA 5669.16	
6	4,5 ... 7,8	44	3001	3011	3501
12	9,0 ... 16,8	175	3002	3012	3502
24	18,0 ... 33,6	720	3003	3013	3503
48	36,0 ... 67,0	2880	3004	3014	3504
60	45,0 ... 84,0	4500	3005	3015	3505
110	82,0 ... 154	15000	3006	3016	3506
				1)	2)

U <sub>N</sub> (DC V)	AgNi - contacts + 5 μm Au			AgSnO <sub>2</sub> - contacts + 0,2 μm Au		
	OA 5669.12	OA 5669.16		OA 5669.12	OA 5669.16	
6	3031	3041	3511	3061	3071	3521
12	3032	3042	3512	3062	3072	3522
24	3033	3043	3513	3063	3073	3523
48	3034	3044	3514	3064	3074	3524
60	3035	3045	3515	3065	3075	3525
110	3036	3046	3516	3066	3076	3526
		1)	2)		1)	2)

1) = Pin configuration standard

2) = Pin configuration reverse

## Ordering Example

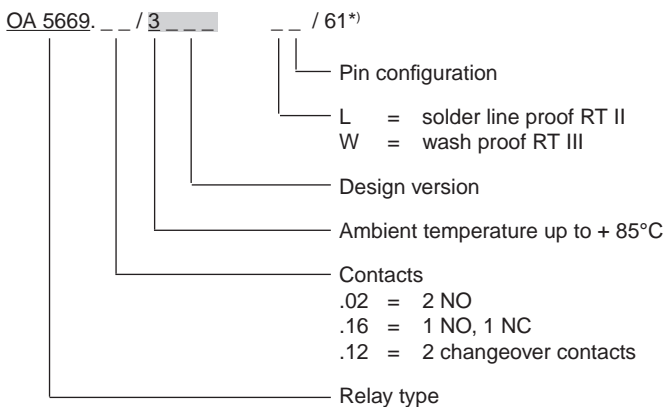

\*) /61 cURus approval

Characteristics

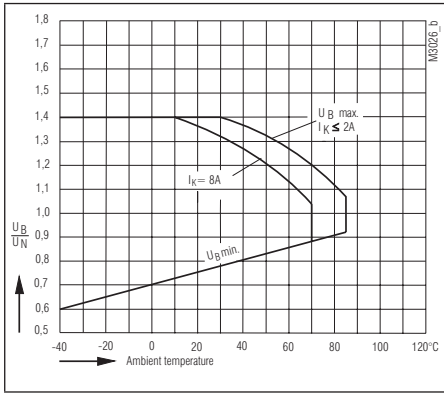

Operating voltage limit curve

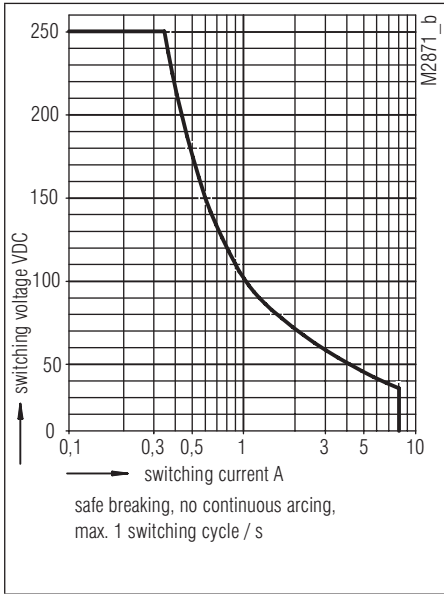

Limit curve for arc-free operation

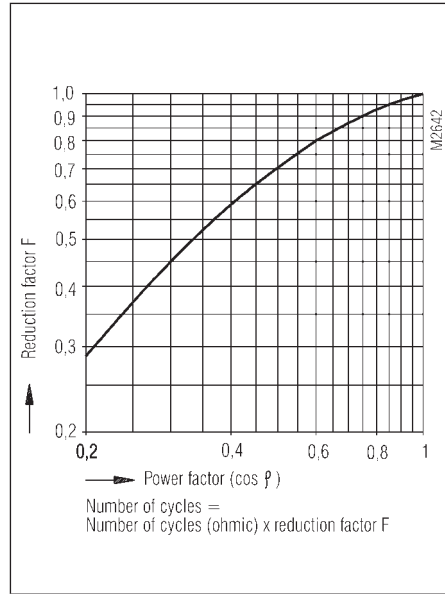

Reduction factor for reactive loads

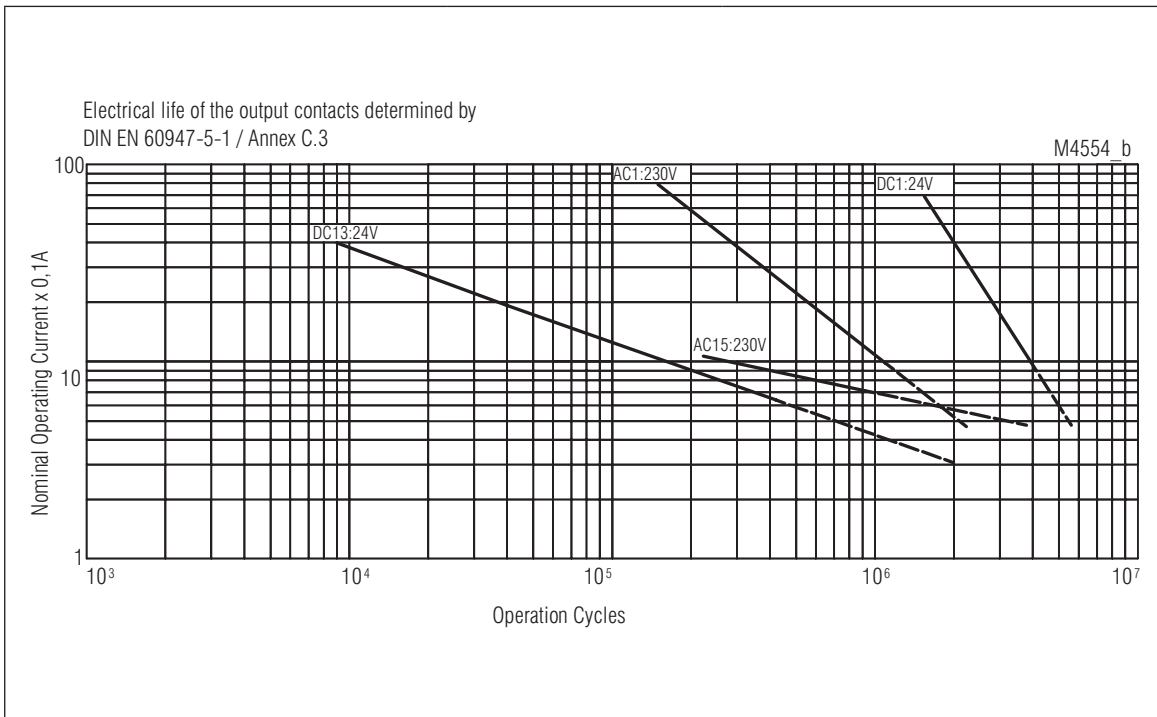

Electrical life for contact material AgNi

Bohrbild (Lötseite)

Pin configuration standard

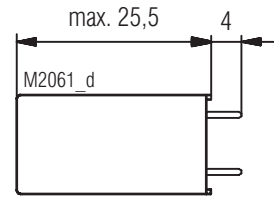
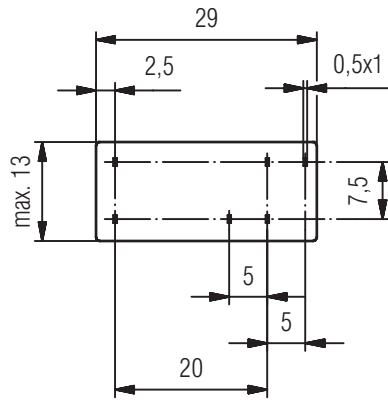
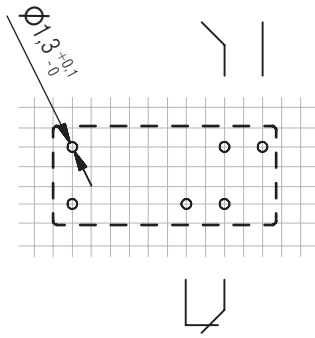

M2061\_d  
OA5669.16  
OW5669.16

Pin configuration reverse

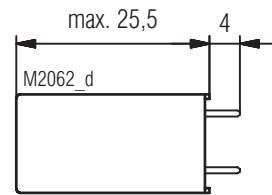
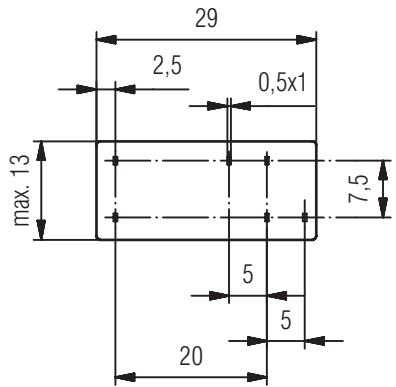
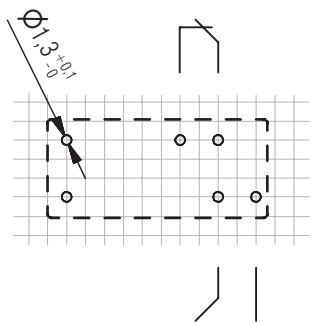

M2062\_d  
OA5669.16  
OW5669.16

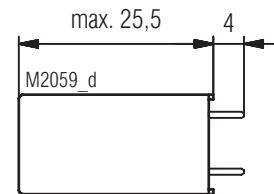
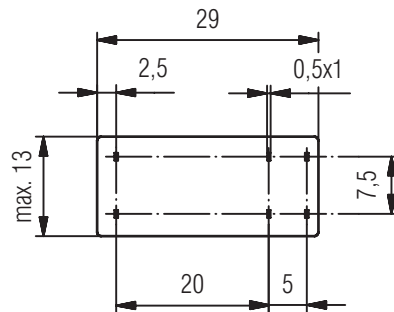
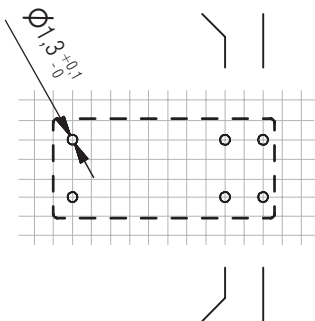

M2059\_d  
OA5668.02  
OW5668.02

OA5669.02  
OW5669.02

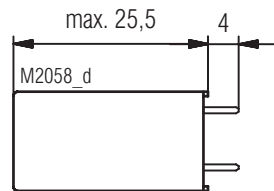
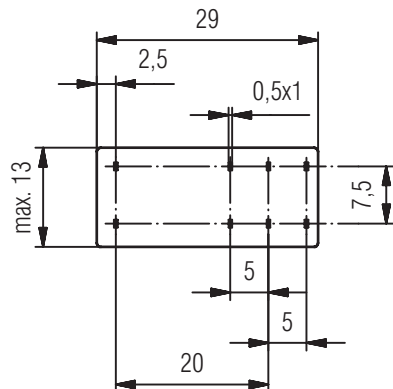
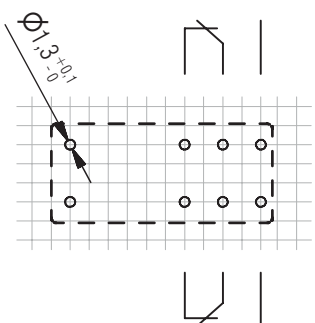

M2058\_d  
OA5668.12  
OW5668.12

OA5669.12  
OW5669.12

Connection for basic grid dimensions 2.5 mm as well as 2.54 mm according to IEC/EN 60097 and IEC 60326 average

<b>Socket ET 1415.021</b> <b>Fixing clip ET 1415.025</b>	<b>Socket ET 1415.041</b>	<b>Socket ET 1415.044</b>	<b>Socket ET 1415.047</b>
	<ul style="list-style-type: none"> <li>• Socket for DIN-rail</li> <li>• incl. fixing clip</li> </ul>	<ul style="list-style-type: none"> <li>• Socket for DIN-rail</li> <li>• incl. fixing clip</li> </ul>	
	<p>Fixing clip</p> <p>Screw terminals</p>	<p>Fixing clip</p> <p>Screw terminals</p>	<p>Fixing clip</p> <p>Cage clamp terminals</p>
<p>Article number: 0034769</p>	<p>Article number: 0055571</p>	<p>Article number: 0059274</p>	<p>Article number: 0059270</p>
	<p>wire connection solid / stranded: 0.14 ... 2.5 mm<sup>2</sup> (14 - 20 AWG) wire connection with sleeved end: 0.14 ... 1.5 mm<sup>2</sup> (14 - 25 AWG)</p>	<p>wire connection solid / stranded: 0.14 ... 2.5 mm<sup>2</sup> (14 - 20 AWG) wire connection with sleeved end: 0.14 ... 1.5 mm<sup>2</sup> (14 - 25 AWG)</p>	<p>wire connection solid / stranded / sleeved end: 2 x (0.2 ... 1.5) mm<sup>2</sup> (16 - 25 AWG)</p>
<p>Fixing clip (wire): 0034770 Fixing clip (plastic): 0047726</p>	<p><b>Function modules</b></p> <p><b>ET1415.913:</b> DC 24 V, with free-wheel diode and green LED    Article number: 0056828  <b>ET1415.911:</b> DC 24 V, with free-wheel diode and red LED    Article number: 0055909  <b>ET1415.924:</b> DC 60 V, with free-wheel diode and red LED    Article number: 0062552  <b>ET1415.912:</b> AC/DC 24 V, with varistor and green LED    Article number: 0055910</p>		

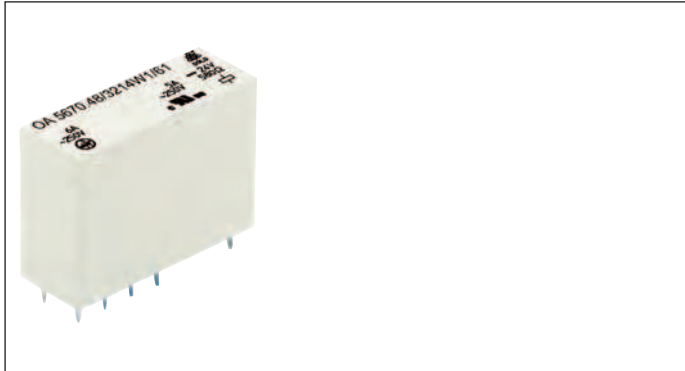

- According to DIN EN 61810-1, DIN EN 61810-3
- With forcibly guided contacts
- **double and reinforced insulation between contact sets acc. to EN 50178**
- High dielectric strength
- High mechanical service life
- High switching reliability
- Compact size
- High thermal continuous current
- High voltage range
- Wash proof model as option

### Applications

- Switchgear for safety technology
- Press controls

### Approvals and Markings

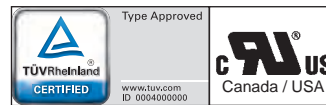

### Technical Data

Relais type		OA 5670
<b>1.0 Relais coil</b>		
1.1 Nominal voltage	DC V	6; 12; 20; 24; 48; 60; 110 (others on request)
1.2 Nominal consumption	W	1.0
1.3 Holding power (at 0.5 x UN)	W	0.25
<b>2.0 Contacts</b>		
2.1 Contact arrangement		2 NO and 2 NC; 3 NO and 1 NC
2.2 Contact material		AgSnO <sub>2</sub> + 0.2 µm Au; AgNi + 0.2 µm Au, AgNi + 5 µm Au
2.3 Rated insulation voltage	AC V	250
Switching voltage min./max.	V	AC/DC 10 / DC 250, AC 400 (AC/DC 2 V / 60 V) <sup>1)</sup>
2.4 Limiting continuous current I <sub>th</sub>	A	3 x 6 (see operating voltage limit curve)
Switching current min./max.	A	10 mA <sup>3)</sup> / 6 (2 mA / 0.3 A) <sup>1)</sup>
2.5 Switching power min./max.	VA	0.1 / 1500 (10 mVA / 12 VA) <sup>1)</sup>
Switching power min./max.	W	0.1 <sup>3)</sup> / 200 (10 mW / 12 W) <sup>1)</sup> (s. limit curve for arc-free operation)
2.6 Switching capacity to IEC/EN 60947-5-1		
AC 15 <sup>4)</sup>	AC V/A	NO: 250 / 2 NC: 250 / 1
AC 15 <sup>5)</sup>	AC V/A	NO: 250 / 3 NC: 250 / 1
DC 13 <sup>4)</sup>	DC V/A	NO: 24 / 1 NC: 24 / 1
DC 13 <sup>4)</sup> at 0.1 Hz to UL 508	DC V/A	NO: 24 / 4 NC: 24 / 3 B300 / R300
2.7 Electrical life	switching cycles	at 1 s On, 1 s Off (see contacts service life)
at AC 230 V, 6 A, cos φ = 1	switching cycles	> 2,6 x 10 <sup>5</sup> AgNi
at DC 24 V, 6 A ohmsch	switching cycles	> 4 x 10 <sup>6</sup> AgNi
2.8 Switching frequency max.	switching cycles/s	10
2.9 Response time / Release time	ms	typically 11 / typically 6
2.10 Contact force NO / NC	cN	≥ 10
<b>3.0 Other</b>		
3.1 Mechanical life	switching cycles	≥ 50 x 10 <sup>6</sup>
3.2 Temperature range	°C	- 40 ... + 75
3.3 Degree of protection, housing		Solder line proof RT II as option wash proof RT III
3.4 Test procedure		A (group mounting)
3.5 Vibration resistance		10 ... 200 Hz; NC 5 g; NO 10 g; IEC/EN 60068-2-6
3.6 Climate resistance		40 / 075 / 04; A / B / D IEC/EN 60068-1
3.7 Short circuit strength 1 kA / AC 250 V	AgNi or AgSnO <sub>2</sub>	6 A gL IEC/EN 60947-5-1

<sup>1)</sup> Values for AgNi-Contacts + 5 µm Au

<sup>2)</sup> 10 A total current at t = 20°C and coil voltage U<sub>N</sub>

<sup>3)</sup> Typical values for AgSnO<sub>2</sub> and AgNi

<sup>4)</sup> Values for AgNi-Contacts

<sup>5)</sup> Values for AgSnO<sub>2</sub>-Contacts

## Technical Data

3.8	Insulation acc. to IEC 60664-1, EN 50178		<b>double and reinforced insulation</b>
	Rated insulation voltage	AC V	250
	Pollution degree		3
	Overtoltage category		III
	Test voltage		
	Contact-Coil (1 min)	AC kV eff.	≥ 4
	Left contact-right contact (1min)	AC kV eff.	≥ 4
	Contact-Coil (1min)	AC kV eff.	≥ 3
	Open contact acc. to DIN EN 61810-1	AC kV eff.	1.5
	Transient voltage		
	Contact-Coil (1.2 - 50 μs)	kV	≥ 6
	Clearance and creepage distances		
	Contact-Coil	mm	≥ 8
	Left contact-right contact	mm	≥ 5.5
	Contact-Contact	mm	≥ 4.5
3.9	Weight	g	approx. 21
<b>4.0 Packing</b>			
4.1	on cardboard	piece	42
4.2	in case package	piece	210
<b>5.0 Solder method</b>			
5.1	Solder method /-temperature /-duration	°C / s	Wafer soldering / 260 / 5

## Design Versions

U <sub>N</sub> (DC V)	Voltage range (DC V)	Resistance at 20°C Ω±10%	OA 5670	
			.52	.48
			2NO, 2NC	3NOS, 1NC
AgNi10 + 0,2 μm Au-contacts				
6	4.2 ... 8.4	36	3201	3211
12	8.4 ... 16.8	150	3202	3212
20	14.0 ... 28.0	400	3203	3213
24	16.8 ... 33.6	580	3204	3214
48	33.6 ... 67.2	2300	3205	3215
60	42.0 ... 84.0	3600	3206	3216
110	77.0 ... 154.0	12100	3207	3217
AgSnO <sub>2</sub> + 0,2 μm Au-contacts				
6	4.2 ... 8.4	36	3221	3231
12	8.4 ... 16.8	150	3222	3232
20	14.0 ... 28.0	400	3223	3233
24	16.8 ... 33.6	580	3224	3234
48	33.6 ... 67.2	2300	3225	3235
60	42.0 ... 84.0	3600	3226	3236
110	77.0 ... 154.0	12100	3227	3237
AgNi10 + 5 μm Au-contacts				
6	4.2 ... 8.4	36	3241	3251
12	8.4 ... 16.8	150	3242	3252
20	14.0 ... 28.0	400	3243	3253
24	16.8 ... 33.6	580	3244	3254
48	33.6 ... 67.2	2300	3245	3255
60	42.0 ... 84.0	3600	3246	3256
110	77.0 ... 154.0	12100	3247	3257

## Ordering Example

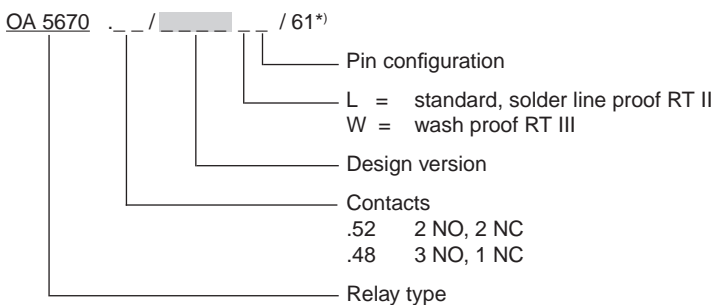

\*) /61 cURus approval



Characteristics

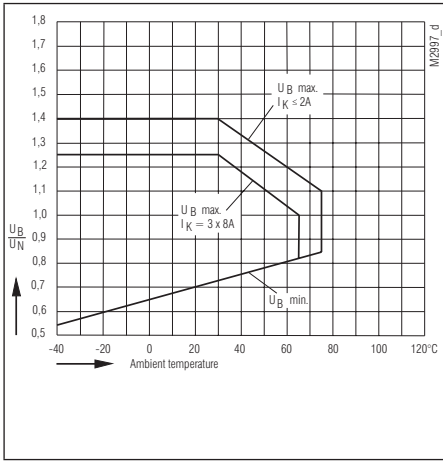

Operating voltage limit curve

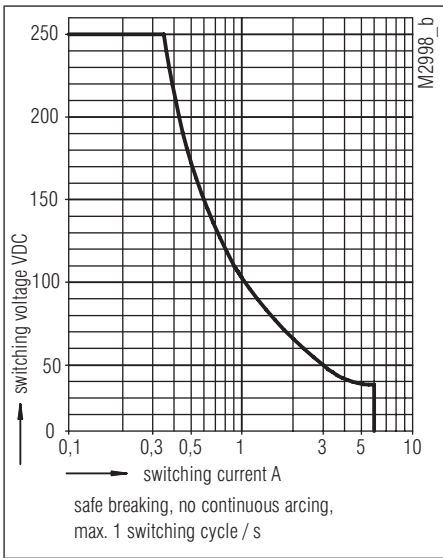

Limit curve for arc-free operation

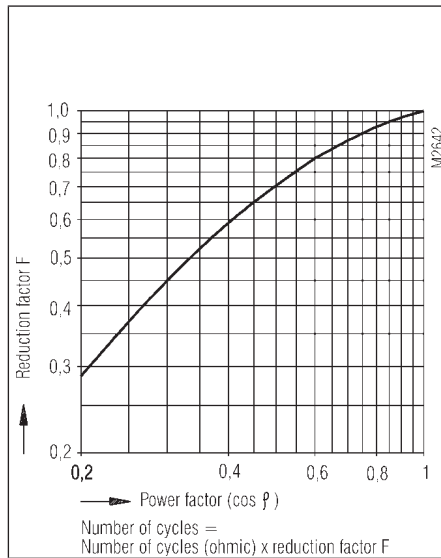

Reduction factor for reactive loads

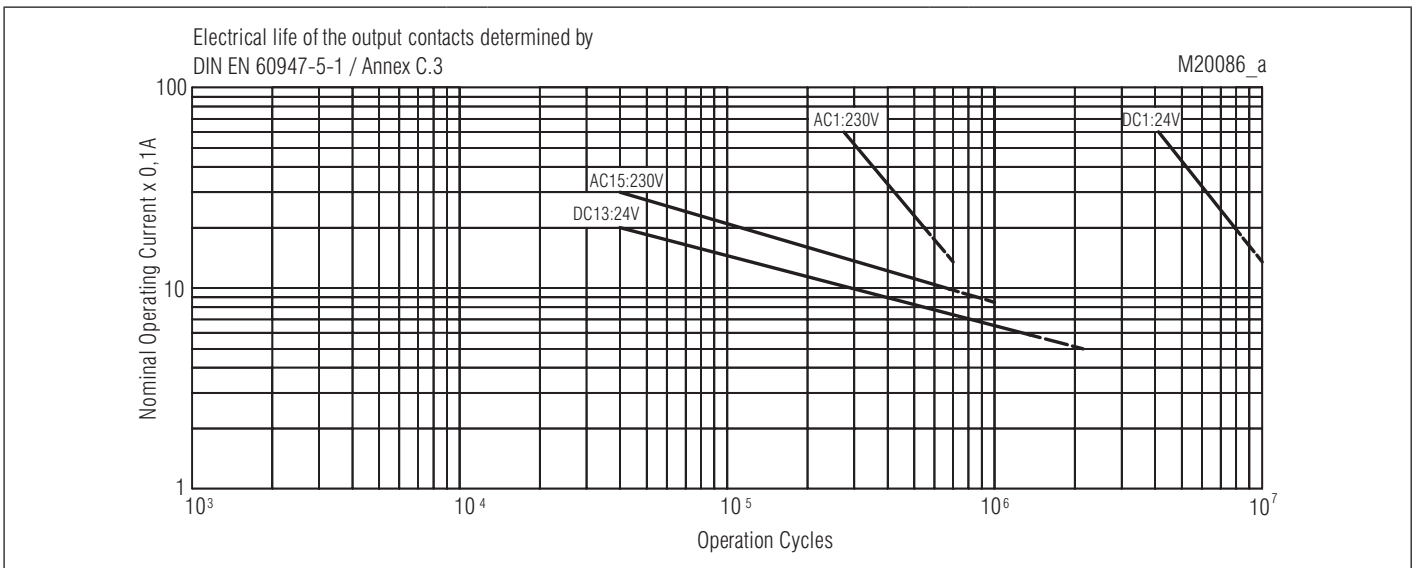

Electrical life for contact material AgNi

Drilling plan (solder side)

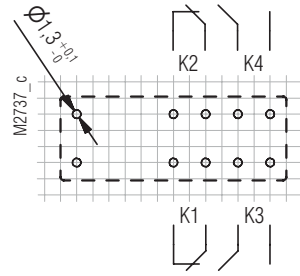
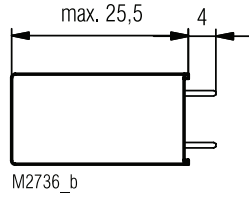
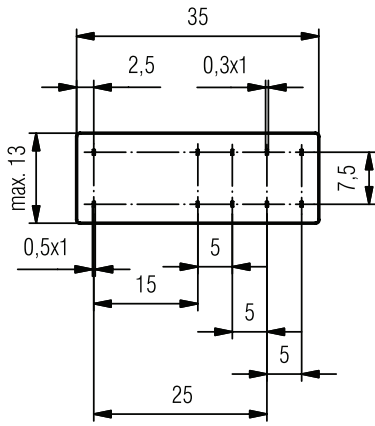

OA5670.52\_\_L1 2NO/2NC

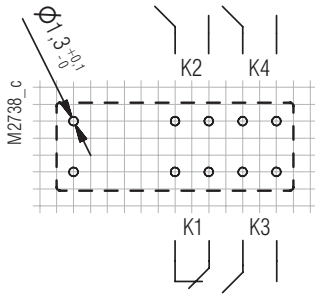

OA5670.48\_\_L1 3NO/1NC

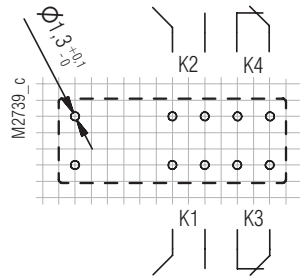

OA5670.52\_\_L2 2NO/2NC

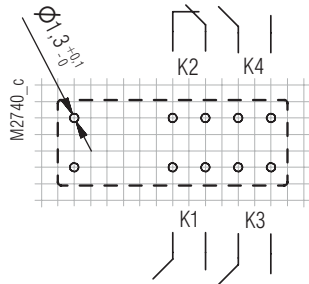

OA5670.48\_\_L2 3NO/1NC

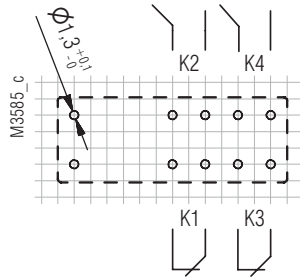

OA5670.52\_\_L3 2NO/2NC

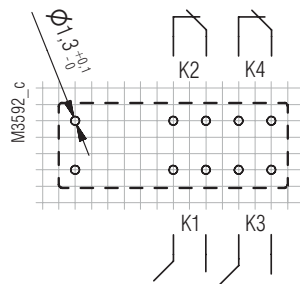

OA5670.52\_\_L4 2NO/2NC

Connection for basic grid dimensions 2.5 mm as well as 2.54 mm according to IEC/EN 60097 and IEC 60326 average

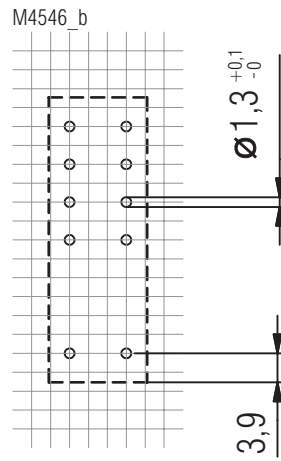
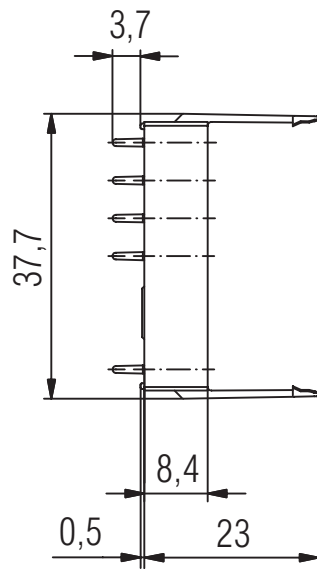
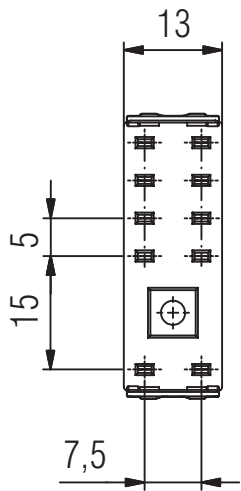

Article number: 0064297



---

---

## 

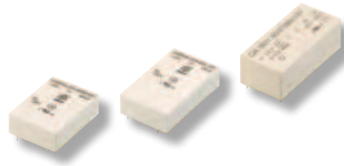

## PCB relays

- monostable
- bistabl

---

##

## Printed Circuit Board Relays

monostable

OA 5651, OA 5652, OA 5661, OA 5662, OA 5692

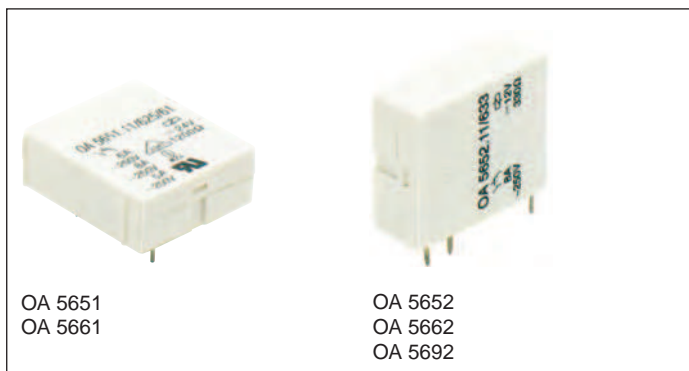

- According to DIN EN 61810-1, DIN EN 60664-1
- Different pin configurations and pin arrangements
- Clearance and creepage distances:  
contact-coil  $\geq 8$  mm
- Compact size, small height (horizontal model)
- OA 5651, 5661 horizontal models
- OA 5652, 5662, 5692 vertical models
- Solder line proof

### Applications

- Control technique
- Interface

### Approvals and Markings



### Technical Data

Relay type		OA 5651, OA 5652, OA 5661, OA 5662, OA 5692
<b>1.0 Relay coil</b>		
1.1 Nominal voltage	DC V	6, 12, 15, 20, 24, 48, 60 (others on request)
1.2 Nominal consumption	W	0.48
1.11 Voltage range	$U_N$	0.7 ... 1.8
1.13 Holding power (at $0.5 \times U_N$ )	W	0.12
<b>2.0 Contacts</b>		
2.1 Contact arrangement		1 changeover contact <sup>1)</sup>
2.2 Contact material		AgSnO <sub>2</sub> + 0.2 $\mu$ m Au; AgNi + 0.2 $\mu$ m Au
2.3 Rated insulation voltage	AC V	250
Switching voltage min./max.	V	10 / 400
2.4 Limiting continuous current $I_{th}$	A	8 (see operating voltage limit curve)
Switching current min./max.	A	10 mA <sup>4)</sup> / 10 <sup>2)</sup>
2.5 Switching power min./max.	VA	4 / 2000
Switching power min./max.	W	30 ... 250 (see limit curve for arc-free operation)
2.6 Switching capacity to IEC/EN 60947-5-1		
AC 15		NC: 230 / 1; NO: 230 / 3
DC 13	AC V/A	NC: 24 / 1; NO: 24 / 1
to UL 508	DC V/A	B150
2.7 Electrical life		at 1 s On, 1 s Off (see contacts service life)
at AC 250 V, 8 A, $\cos\phi = 1$	switching cycles	$> 2 \times 10^5$ AgNi 10 $> 3 \times 10^5$ AgSnO <sub>2</sub>
2.8 Switching frequency max.	switching cycles/s	20
2.9 Response time / Release time	ms	typically 5 / typically 7
2.10 Contact force	cN	$> 25$ / $>10$ ; $> 10^3$ / $>8^3$
2.14 Contact gap	mm	$> 0,5^2)$
<b>3.0 Other</b>		
3.1 Mechanical life	switching cycles	$30 \times 10^6$
3.2 Temperature range	$^{\circ}$ C	- 40 ... + 80
3.3 Degree of protection		Solder line proof RT II
3.5 Vibration resistance		$\geq 4$ g, to max. 100 Hz, IEC/EN 60068-2-6
3.6 Climate resistance		40 / 080 / 04 (climate category); A/B/D IEC/EN 60068-1

<sup>1)</sup> NO and NC on request

<sup>2)</sup> max. 4 s or 10 % ED

<sup>3)</sup> at OA 5651, OA 5652

<sup>4)</sup> Typical values

## Technical Data

3.8	Insulation acc. to IEC 60664-1, EN 50178		
	Rated insulation voltage	AC V	250
	Pollution degree		3
	Overtoltage category		III
	Test voltage		
	Contact- Coil (1 min)	AC kV eff.	≥ 4
	Transient voltage		
	Contact- Coil (1,2 - 50 μs)	kV	≥ 6
	Clearance and creepage distances	mm	≥ 8
3.9	Weight	g	13
<b>4.0 Packing</b>			
4.1	in blister	piece	20
4.2	in case package	piece	200
<b>5.0 Solder method</b>			
5.1	Solder method /-temperature /-duration	°C / s	Wafer soldering / 260 / 5

## Design Versions

U <sub>N</sub> DC V	Voltage range DC V	Resistance at 20°C Ω	AgNi10-contacts + 0.2 μm Au					AgSnO <sub>2</sub> -contacts + 0.2 μm Au				
			OA 5651	OA 5652	OA 5661	OA 5662	OA 5692	OA 5651	OA 5652	OA 5661	OA 5662	OA 5692
6	4,2 ... 10,8	80	621	635	285	270	411	651	665	323	328	432
12	8,4 ... 21,6	330	622	636	286	271	412	652	666	324	329	433
15	10,5 ... 27,0	475	623	637	291	272	413	653	667	321	330	434
20	14,0 ... 36,0	880	624	638	287	273	414	654	668	325	331	435
24	16,8 ... 43,2	1 200	625	639	288	274	415	655	669	326	332	436
48	33,6 ... 86,4	4 700	626	640	289	275	416	656	670	327	333	437
60	42,0 ... 108,0	7 250	627	641	293	276	417	657	671	322	334	438

## Ordering Example

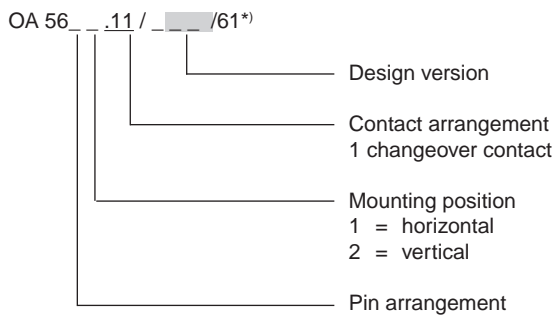

\*) /61 cURus approval

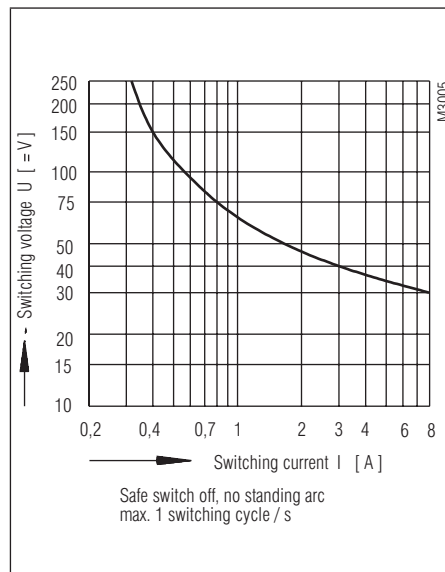
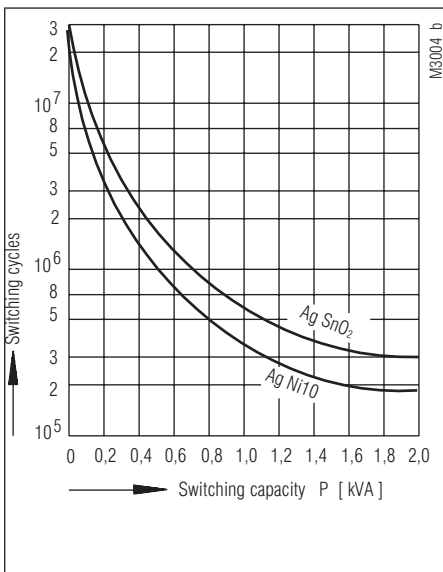
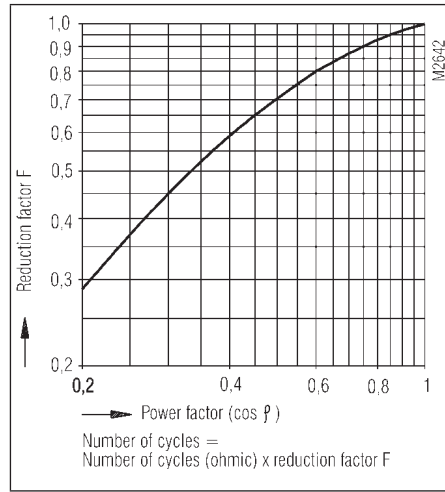
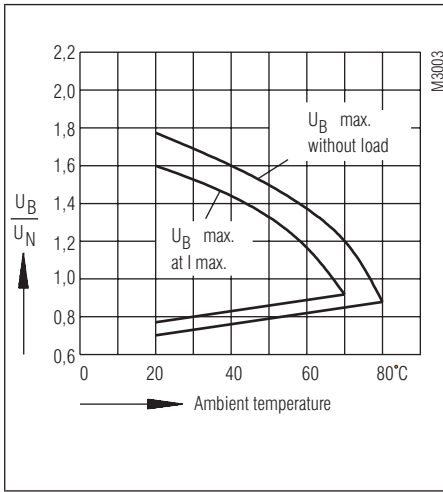



Drilling plan (solder side)

OA 5651

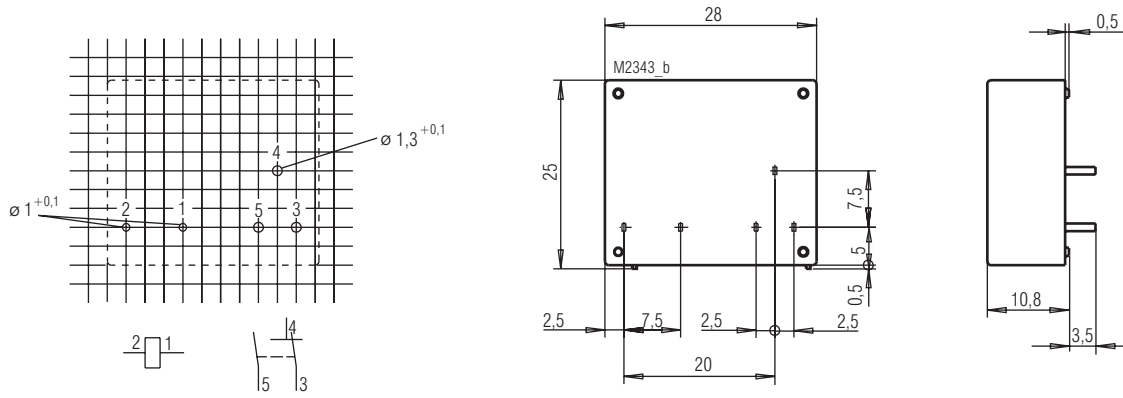

OA 5652

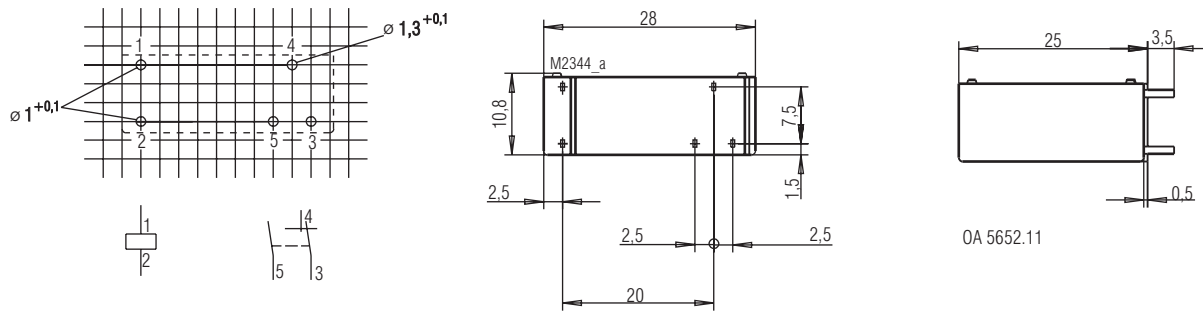

OA 5652.11

OA 5661

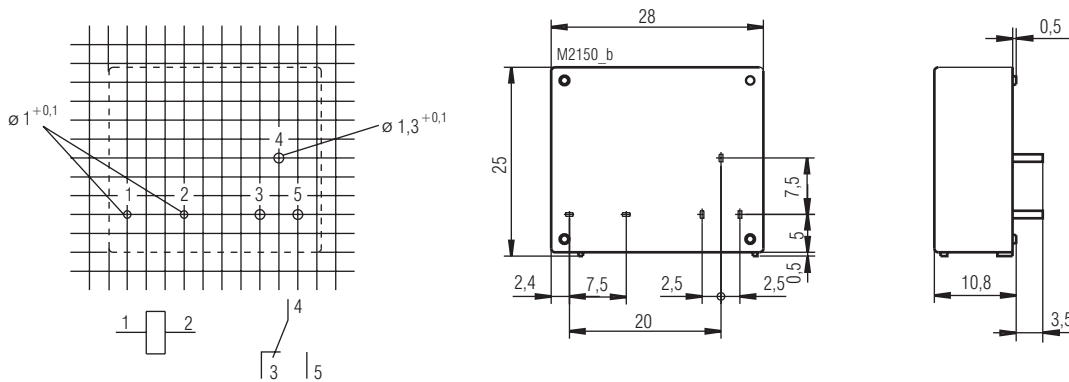

OA 5662

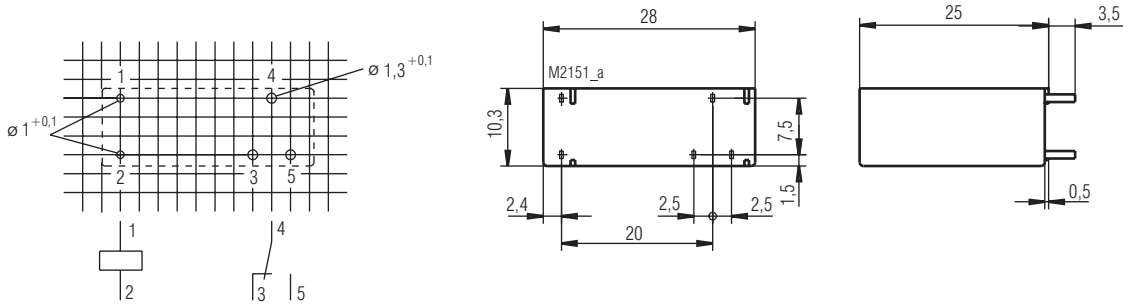

OA 5662.11

Connection for basic grid dimensions 2.5 mm as well as 2.54 mm according to IEC/EN 60097 and IEC 60326 average

Drilling plan (solder side)

OA 5692

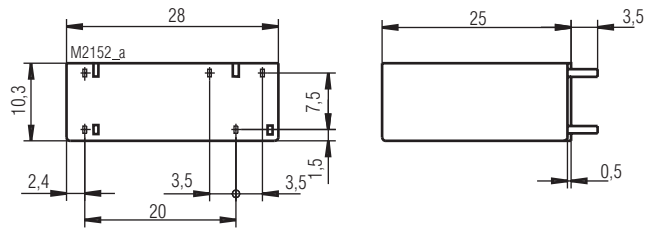
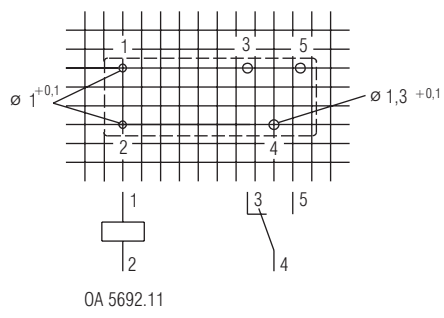

Connection for basic grid divisions 2.5 mm as well as 2.54 mm according to IEC/EN 60097 and IEC 60326 average

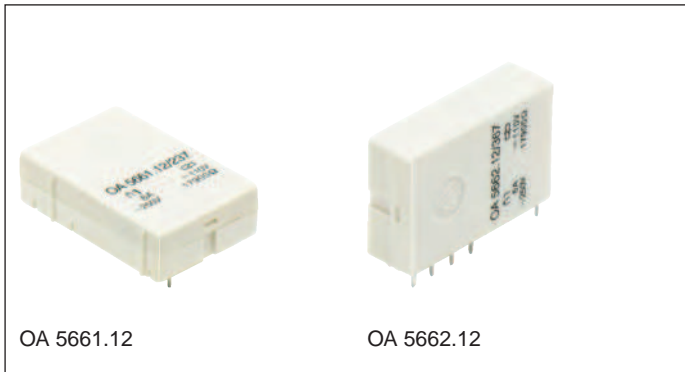

- According to DIN EN 61810-1, DIN EN 60664-1
- Low rated power consumption
- 2 changeover contacts
- Clearance and creepage distances:  
contact - coil  $\geq 8$  mm
- Adjustment to customers specification
- Compact size, small height (at horizontal model)
- OA 5661.12 horizontal mounting
- OA 5662.12 vertical mounting
- Solder line proof

### Applications

- Control technique
- Interface

### Approvals and Markings



### Technical Data

Relay type		OA 5661.12, OA 5662.12
<b>1.0 Relay coil</b>		
1.1 Nominal voltage	DC V	6; 12; 20; 24; 48; 60 (others on request)
1.2 Nominal consumption	W	0.7
1.11 Voltage range	$U_N$	0.7 ... 1.4
1.13 Holding power (at 0.5 x $U_N$ )	W	0.18
<b>2.0 Contacts</b>		
2.1 Contact arrangement		2 changeover contact
2.2 Contact material		AgSnO <sub>2</sub> + 0.2 $\mu$ m Au; AgNi + 0.2 $\mu$ m Au
2.3 Rated insulation voltage	AC V	250
Switching voltage min./max.	AC V	2 x 10 / 400
2.4 Limiting continuous current $I_{th}$	A	2 x 6 (see operating voltage limit curve)
Switching current min./max.	A	2 x 10 mA <sup>2)</sup> / 8 <sup>1)</sup>
2.5 Switching power min./max.	VA	2 x 4 / 1 500
Switching power min./max.	W	2 x 30 ... 200 (see limit curve for arc-free operation)
2.6 Switching capacity to IEC/EN 60947-5-1		
AC 15	AC V/A	NC: 230 / 1; NO: 230 / 3
DC 13	DC V/A	NC: 24 / 1; NO: 24 / 1
to UL 508		B150
2.7 Electrical life		at 1 s On, 1 s Off (see contacts service life)
at AC 230 V, 6 A, $\cos\phi = 1$	switching cycles	4 x 10 <sup>5</sup> AgNi 10    8 x 10 <sup>5</sup> AgSnO <sub>2</sub>
2.8 Switching frequency max.	switching cycles/s	20
2.9 Response time / Release time	ms	typically 5 / typically 7
2.10 Contact force	cN	> 25 / > 10
2.14 Contact gap	mm	> 0.5 <sup>2)</sup>
<b>3.0 Other</b>		
3.1 Mechanical life	switching cycles	30 x 10 <sup>6</sup>
3.2 Temperature range	°C	- 40 ... + 70
3.3 Degree of protection		Solder line proof RT II
3.5 Vibration resistance		4 g, to max. 100 Hz IEC/EN 60068-2-6
3.6 Climate resistance		40 / 070 / 04 (climate category); A / B / D IEC/EN 60068-1

<sup>1)</sup> max. 4 s; or. 10 % ED

<sup>2)</sup> Typical values

## Technical Data

3.8	Insulation acc. to IEC 60664-1, EN 50178		
	Rated insulation voltage	AC V	250
	Pollution degree		3
	Overtoltage category		III
	Test voltage		
	Contact- Coil (1 min)	AC kV eff.	≥ 4
	Contact - Contact (1min)	AC kV eff.	≥ 2.5
	Transient voltage		
	Contact- Coil (1.2 - 50 μs)	kV	≥ 6
	Clearance and creepage distances		
	Contact- Coil	mm	≥ 8
3.9	Weight	g	16
<b>4.0 Packing</b>			
4.1	in blister	piece	20
4.2	in case package	piece	200
<b>5.0 Solder method</b>			
5.1	Solder method /-temperature /-duration	°C / s	Wafer soldering / 260 / 5

## Design Versions

U <sub>N</sub> DC V	Voltage range	Resistance at 20°C	AgNi10-contacts		AgSnO <sub>2</sub> -contacts	
	DC V	Ω	OA 5661.12	OA 5662.12	OA 5661.12	OA 5662.12
6	4,2 ... 8,4	55	231	240	335	341
12	8,4 ... 16,8	220	232	241	336	342
20	14,0 ... 28,0	660	233	242	337	343
24	16,8 ... 33,6	880	234	243	338	344
48	33,6 ... 67,0	3 200	235	244	339	345
60	42,0 ... 84,0	4 700	236	245	340	346

## Ordering Example

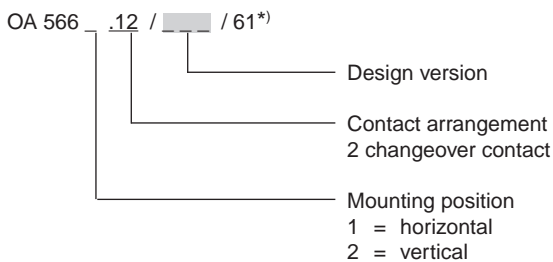

\*) /61 cURus approval

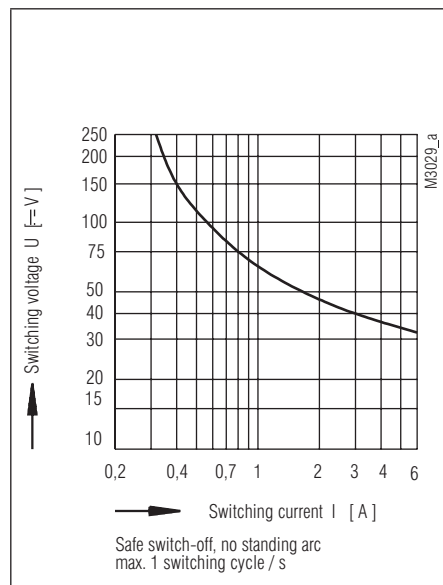
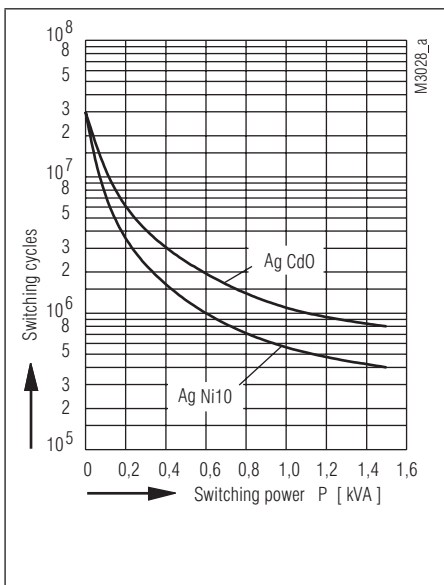
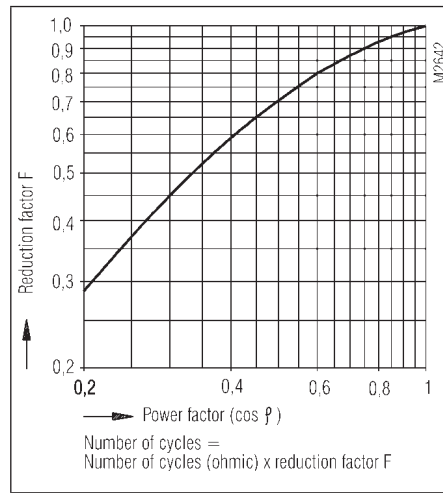
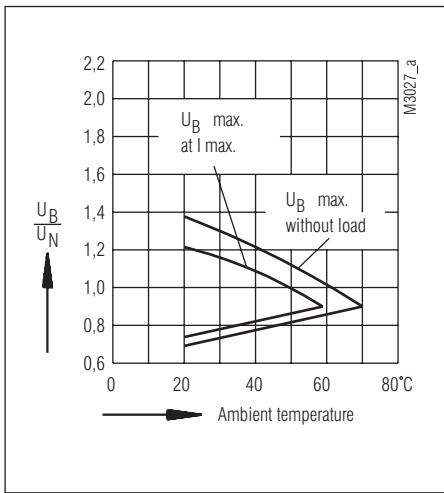

Drilling plan (solder side)

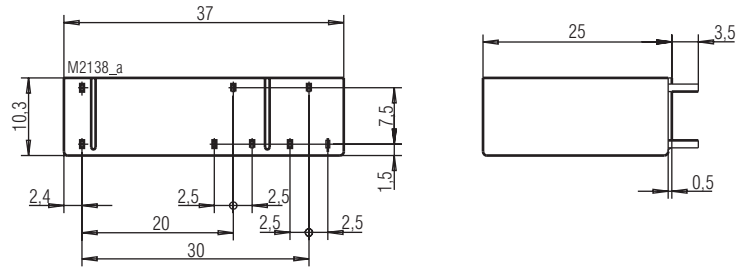
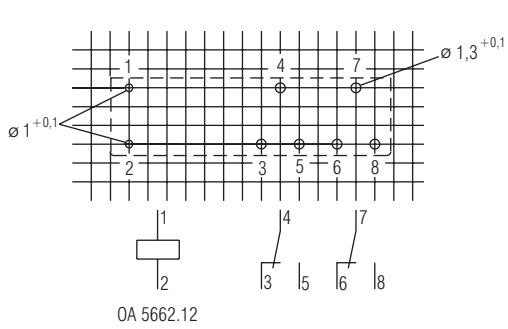
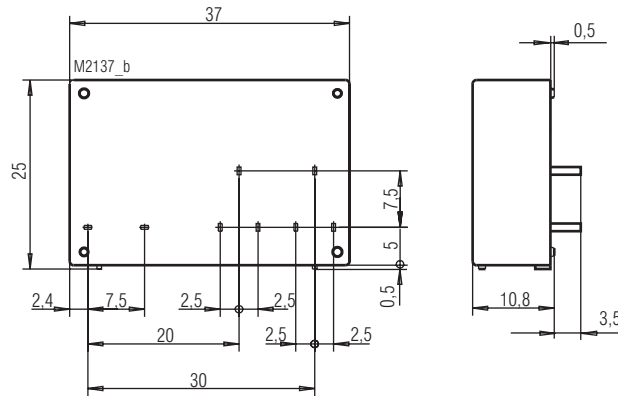
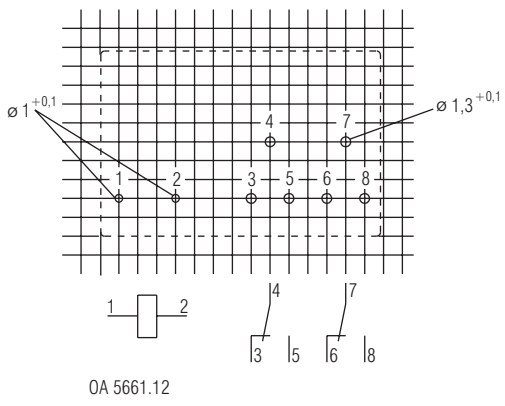

Connection for basic grid dimensions 2.5 mm as well as 2.54 mm according to IEC/EN 60097 and IEC 60326 average

## Printed Circuit Board Relays

monostable

OA 5671, OA 5681, OA 5672, OA 5682

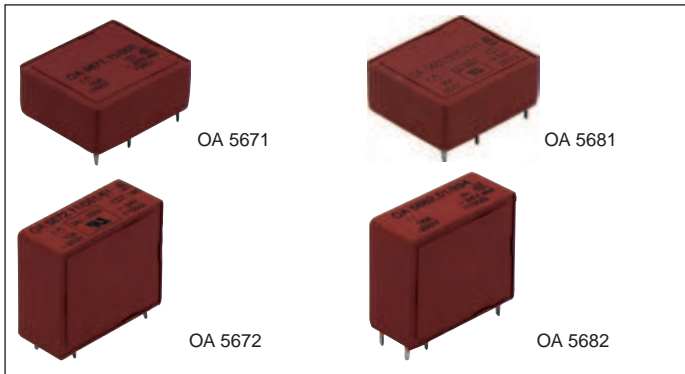

- According to DIN EN 61810-1, DIN EN 60664-1
- Clearance and creepage distances:  
contact-coil  $\geq 8$  mm
- Compact size, small height (at horizontal model)
- OA 5671 / 5681 horizontal mounting
- OA 5672 / 5682 vertical mounting
- OA 5671 and OA 5672 for continuous currents to 10 A or with contact with  $5 \mu\text{m Au}$
- OA 5681 and OA 5682 for continuous currents to 16 A
- OA 5672 as option with 7 mm or 10 mm pin distance
- For continuous operating temperature to  $110^\circ\text{C}$
- Voltage range  $0.7 U_N \dots 2.2 U_N$
- Solder line proof

### Applications

- Control technique
- Interface

### Approvals and Markings



### Technical Data

Relay type	OA 5671, OA 5672		OA 5681, OA 5682	
<b>1.0 Spule</b>				
1.1 Nominal voltage	DC V	6, 12, 15, 20, 24, 48, 60, 110 (others on request)		
1.2 Nominal consumption	W	0.53		
1.11 Voltage range	$U_N$	0.7 ... 2.2		
1.13 Holding power (at $0.5 \times U_N$ )	W	0.14		
<b>2.0 Contacts</b>				
2.1 Contact arrangement <sup>1)</sup>	1 changeover contact			
2.2 Contact material	$\text{AgSnO}_2 + 0.2 \mu\text{m Au}$			
2.3 Rated insulated voltage	AC V	250		
Switching voltage min./max.	DC V, AC V	12 / 250, 400 ( $\approx 100\text{mV} / \approx 60\text{V}$ ) <sup>4)</sup>		12 / 250, 400
2.4 Limiting continuous current $I_{th}$	A	10 <sup>5)</sup>		16 <sup>5)</sup>
Switching current min./max.	A	10 mA <sup>7)</sup> / 16 (1 mA / 0.3 A) <sup>4)</sup>		0.3 / 25 <sup>2)</sup>
2.5 Switching power min./max.	VA	4 / 2 500 (1 mVA / 7 VA) <sup>4)</sup>		4 / 4 000
Switching power min./max.	W	35 ... 300 <sup>6)</sup> (1mW / 7 W) <sup>4)</sup>		35 ... 500 <sup>6)</sup>
2.6 Switching capacity to IEC/EN 60947-5-1				
AC 15	AC V/A	NC: 230 / 5; NO: 230 / 10		
DC 13	DC V/A	NC: 24 / 1; NO: 24 / 1		
to UL 508		B150		
2.7 Electrical life <sup>3)</sup>	switching cycles	(50 x 10 <sup>6</sup> ) <sup>4)</sup>		
at AC 250 V, $I_{th}$ (OA/OW)	switching cycles	approx. 0.3 x 10 <sup>6</sup> / approx. 0.15 x 10 <sup>6</sup>	approx. 0.2 x 10 <sup>6</sup> / approx. 0.1 x 10 <sup>6</sup>	
2.8 Switching frequency max.	switching cycles / s	20		
2.9 Response time / Release time	ms	typically 7 / typically 3		
2.10 Contact force NO / NC	cN	25 / 12		
<b>3.0 Other</b>				
3.1 Mechanical life	switching cycles	approx. 30 x 10 <sup>6</sup>		
3.2 Temperature range	$^\circ\text{C}$	- 40 ... + 110		
3.3 Degree of protection, housing	Solder line proof RT II			
3.5 Vibration resistance	$\leq 10$ g, to 100 Hz IEC/EN 60068-2-6			
3.6 Climate resistance	40 / 110 / 04 (climate category); A/B/D IEC/EN 60068-1			

<sup>1)</sup> NO and NC on request

<sup>2)</sup> max. 4 s or 10 % ED

<sup>3)</sup> at 0,5 s On, 3,5 s Off

<sup>4)</sup> Values for contact with  $5 \mu\text{m Au}$

<sup>5)</sup> see operating voltage limit curve

<sup>6)</sup> see limit curve for arc free operation

<sup>7)</sup> Typical values

## Technical Data

3.8	Insulation acc. to IEC 60664-1, EN 50178		
	Rated insulation voltage	AC V	250
	Pollution degree		3
	Overtoltage category		III
	Test voltage		
	contact-coil (1 min)	AC kV eff.	≥ 4
	contact-contact (1 min)	AC kV eff.	≥ 1.5
	Transient voltage		
	contact-coil (1.2 - 50 μs)	kV	≥ 6
	Clearance and creepage distances	mm	≥ 8
3.9	Weight	g	17
<b>4.0 Packing</b>			
4.1	in blister	piece	OA 5671: 20 OA 5672: 20
			OA 5681: 20 OA 5682: 20
4.2	in case package	piece	OA 5671: 200 or 100 OA 5672: 200 or 100
			OA 5681: 200 or 100 OA 5682: 200 or 100
<b>5.0 Solder method</b>			
5.1	Solder method /-temperature /-duration	°C / s	Wafer soldering / 260 / 5

## Design Versions

U <sub>N</sub> (DC V)	Voltage range (DC V)	Resistance at 20°C Ω	AgSnO <sub>2</sub>			AgSnO <sub>2</sub>		AgNi 10 + 5 μm Au		
			OA 5671	OA 5672 7 mm	OA 5672 10 mm	OA 5681	OA 5682	OA 5671	OA 5672 7 mm	OA 5672 10 mm
6	4,2 ... 13,2	70	001	046	821	851	881	031	076	061
12	8,4 ... 26,4	280	003	048	822	852	882	033	078	063
15	10,5 ... 33,0	420	004	049	823	853	883	034	079	064
20	14,0 ... 44,0	750	005	050	824	854	884	035	080	065
24	16,8 ... 52,8	1100	006	051	825	855	885	036	081	066
48	33,6 ... 105,6	4500	010	055	829	859	889	040	085	070
60	42,0 ... 132,0	7000	011	056	830	860	890	041	086	071
110	77,0 ... 242,0	23000	012	057	831	861	891	042	087	072

## Ordering Example

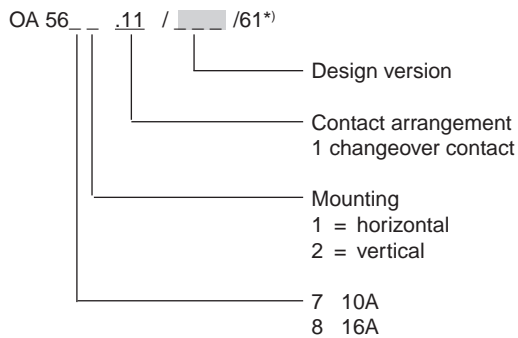

\*) /61 cURus approval



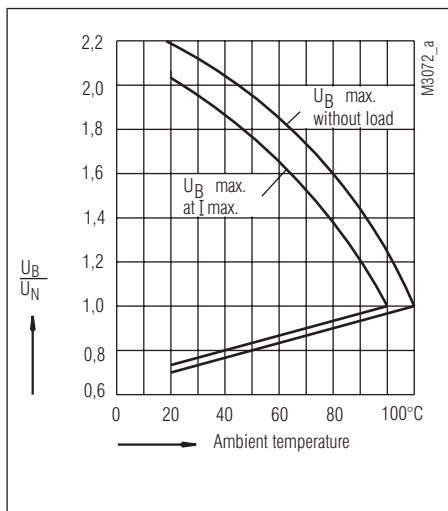

Operating voltage limit curve

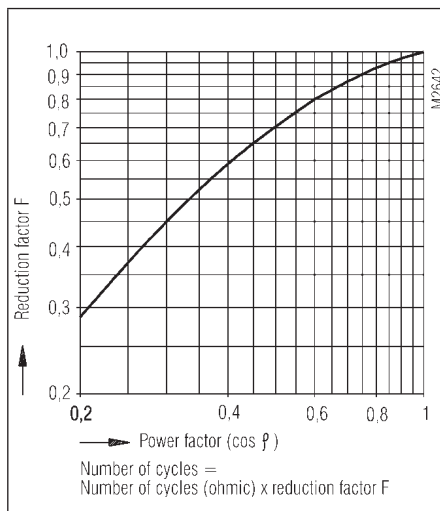

Reduction factor for inductive loads

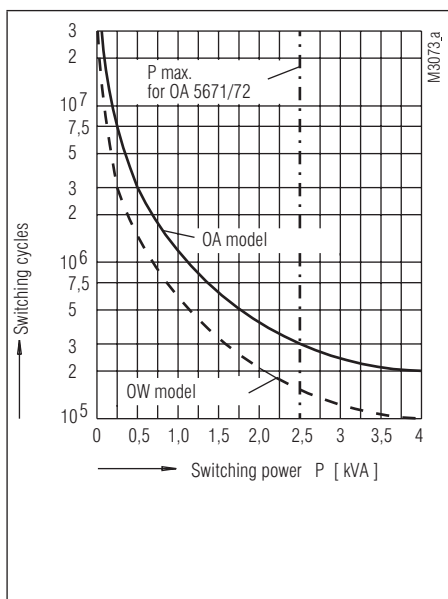

Contact service life (at  $t_u = 20^\circ\text{C}$ )

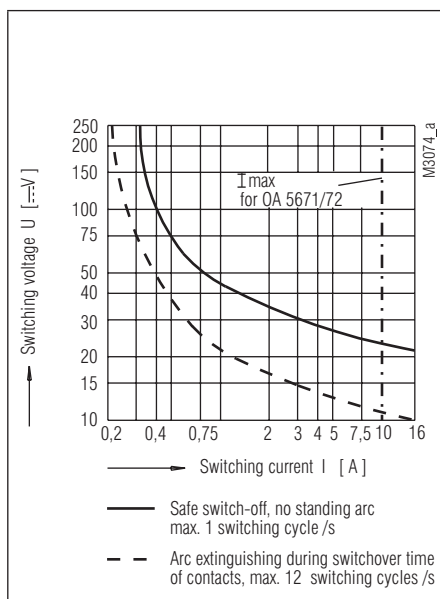

Limit curve for arc-free operation

Drilling plan (solder side)

OA 5671  
10 mm pin distance

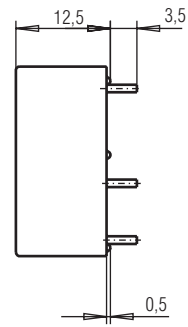
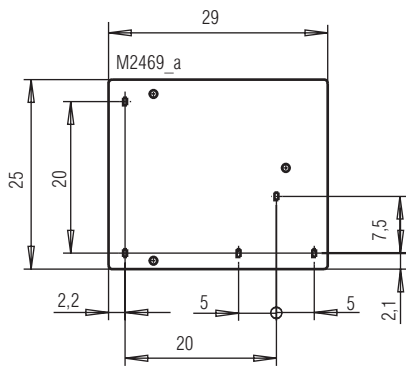
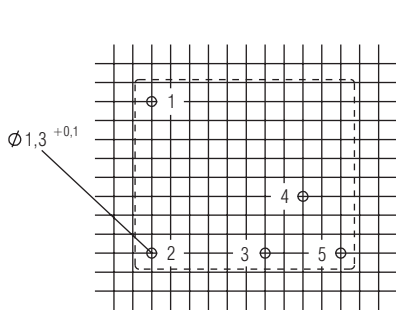

OA 5672  
10 mm pin distance

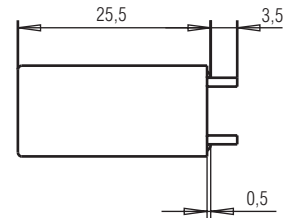
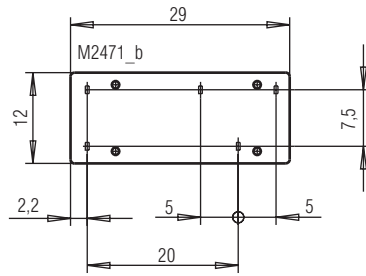
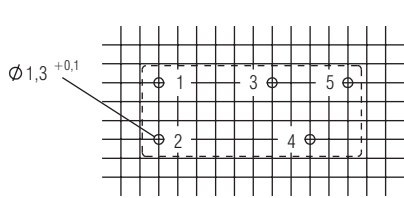

OA 5672  
7 mm pin distance

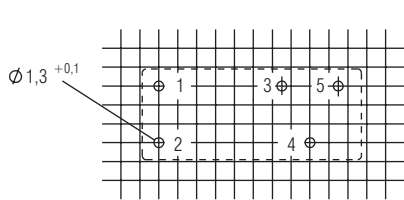

OA 5672

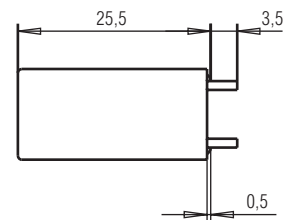
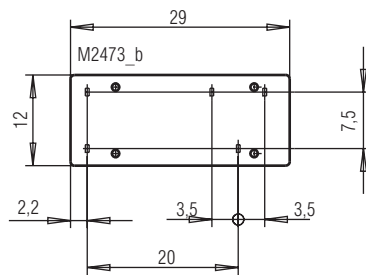

Connection for basic grid dimensions 2.5 mm as well as 2.54 mm according to IEC/EN 60097 and IEC 60326 average

Drilling plan (solder side)

OA 5681  
10 mm pin distance

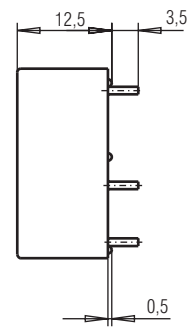
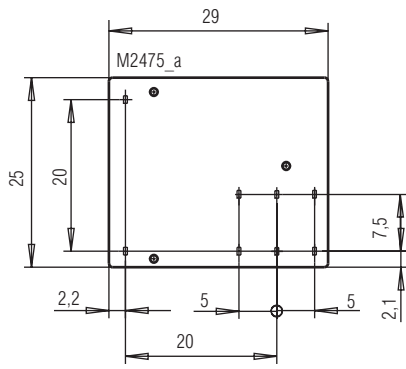
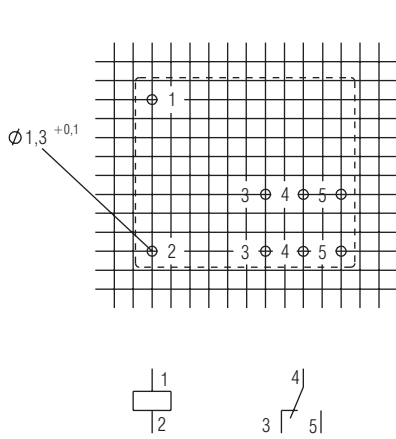

OA 5682  
10 mm pin distance

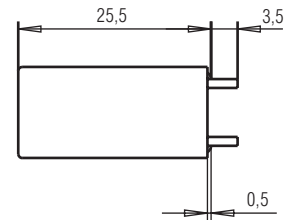
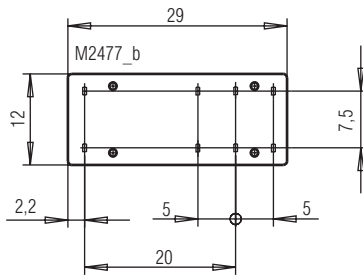
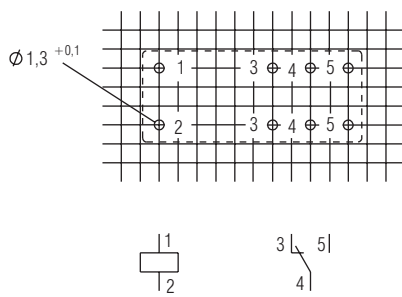

## PCB relays

### Printed circuit board relay monostable OA / OW 5668

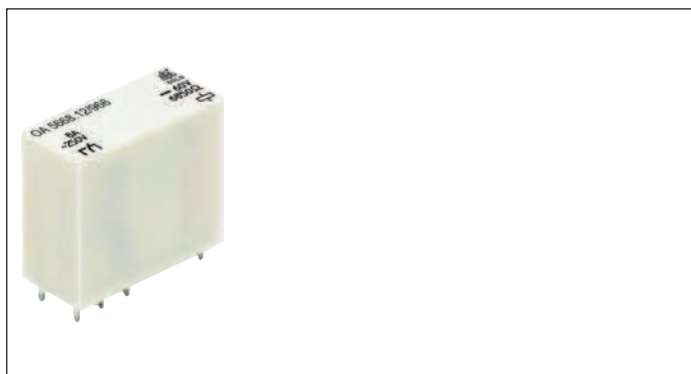

- Acc. to DIN EN 61810-1, DIN EN 60664-1
- Clearance and creepage distances:  
contact - coil  $\geq 8$  mm
- High dielectric strength  $\geq 4$  kV
- High mechanical service life
- High temperature range - 40 ... + 75°C
- As option wash proof RT III

#### Application

- Control technique
- Interface

#### Technical Data

Relay type		OA/OW 5668	
<b>1.0 Relay coil</b>			
1.1 Nominal voltage	DC V	5, 6, 12, 20, 24, 48, 60, 110	
1.2 Nominal consumption	W	approx. 0.5	
1.11 Voltage range	$U_N$	0,7 ... 2,0	
1.3 Holding power (at 0.5 x $U_N$ )	W	approx. 0.13	
<b>2.0 Contacts</b>			
2.1 Contact arrangement		2 changeover contacts, optionally 2 NO or 2 NC	
2.2 Contact material		AgSnO <sub>2</sub> + 0.2 $\mu$ m Au on request; AgNi + 0.2 $\mu$ m Au, AgNi + 5 $\mu$ m Au	
2.3 Rated insulation voltage	AC V	2 x 250	
Switching voltage min./max.	V	AC/DC 10 / DC 250, AC 400 V (AC/DC 100 mV / 60 V) <sup>4)</sup>	
2.4 Limiting continuous current $I_{th}$	A	2 x 5 (s. see operating voltage limit curve)	
Switching current min./max.	A	10 mA <sup>3)</sup> 2 x 8 together or 1 x 10 (1mA / 0.3 A) <sup>4)</sup>	
2.5 Switching power min./max.	VA	2 x 3 / 2 000 together or 1 x 2 500 (1mVA / 7 VA) <sup>4)</sup>	
Switching power min./max.	W	2 x 30 / 160 together or 1 x 200 (1mW / 7 W) <sup>2) 4)</sup>	
2.6 Switching capacity to IEC/EN 60947-5-1			
AC 15	AC V/A	NC: 230 / 1 NO: 230 / 2	
DC 13	DC V/A	NC: 24 / 1 NO: 24 / 1	
2.7 Electrical life		at 1 s On, 1 s Off (see contact service life)	
at AC 230 V, 6 A cos $\varphi = 1$	switching cycles	1.5 x 10 <sup>5</sup>	
2.8 Switching frequency max.	switching cycles / s	20	
2.9 Response time / Release time	ms	$\leq 8 / \leq 10$	
2.10 Contact force	cN	$\geq 10 / \geq 8$	
<b>3.0 Other</b>			
3.1 Mechanical life	switching cycles	$\geq 50 \times 10^6$	
3.2 Temperature range	°C	- 40 ... + 75 mounted without distance ( $I_{th} = 2 \times 5$ A)	
3.3 Degree of protection		Solder line proof RT II as option wash proof RT III	
3.5 Vibration resistance		10 ... 55 Hz; 0,35 mm ampl.; max 5 g IEC/EN 60068-2-6	
3.6 Climate resistance		40 / 075 / 04 (climate catgory); A/B/D IEC/EN 60 068-1	

<sup>1)</sup> I on / I off

<sup>2)</sup> see limit curve for arc-free operation

<sup>3)</sup> Typical values

<sup>4)</sup> Values for AgNi -Contacts + 5  $\mu$ m Au

## Technical Data

3.8	Insulation acc. to IEC 60664-1, EN 50178		
	Rated insulation voltage	AC V	250
	Pollution degree		2
	Overvoltage category		III
	Test voltage		
	contact-coil (1 min)	AC kV eff.	≥ 4
	contact-contact (1 min)	AC kV eff.	≥ 2.5
	Transient voltage		
	contact-coil (1.2 - 50 μs)	kV	≥ 6
	Clearance and creepage distances		
	contact-coil	mm	≥ 8
3.9	Weight	g	35
<b>4.0 Packing</b>			
4.1	on cardboard in slipcase	piece	56
4.2	in case package	piece	280
<b>5.0 Solder method</b>			
5.1	Solder method /-temperature /-duration	°C / s	Wafer soldering / 260 / 5

## Design versions

U <sub>N</sub> DC V	Voltage range DC V	Resistance at 20°C Ω	Design version OA / OW	
			.12	.02
5	3.7 ... 9.5	50	941	571
6	4.5 ... 11.4	70	942	572
12	9.0 ... 22.8	270	943	573
20	15.0 ... 38.0	820	948	578
24	18.0 ... 45.6	1 100	944	574
48	35.0 ... 91.2	4 400	945	575
60	44.0 ... 114.0	6 850	946	576
110	80.0 ... 209.0	20 000	947	577

## Ordering example

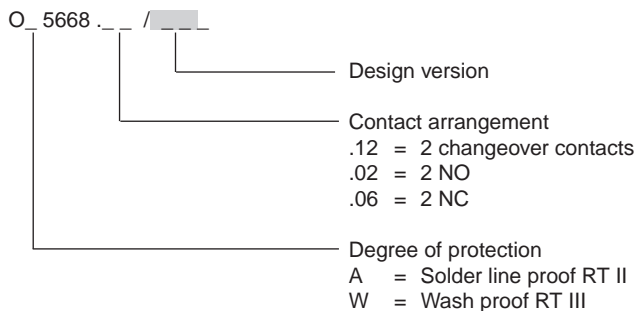

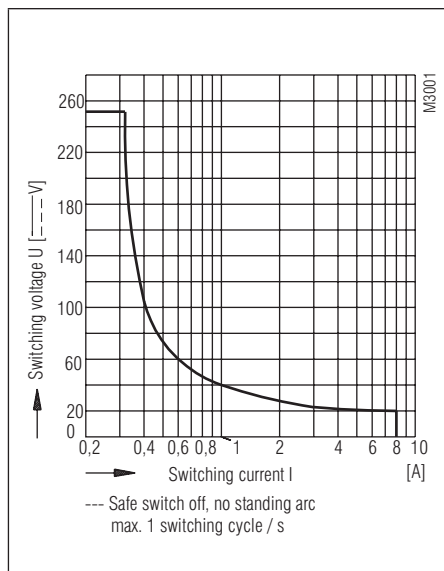
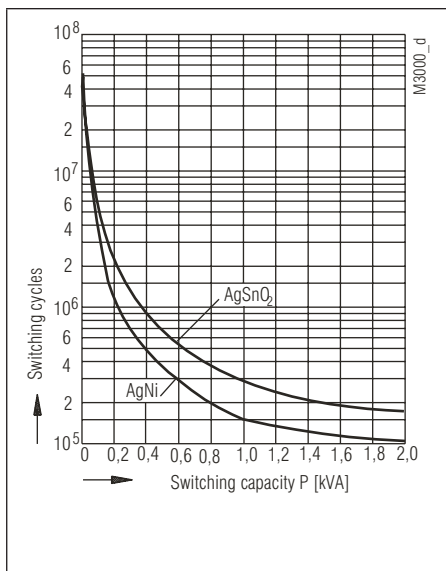
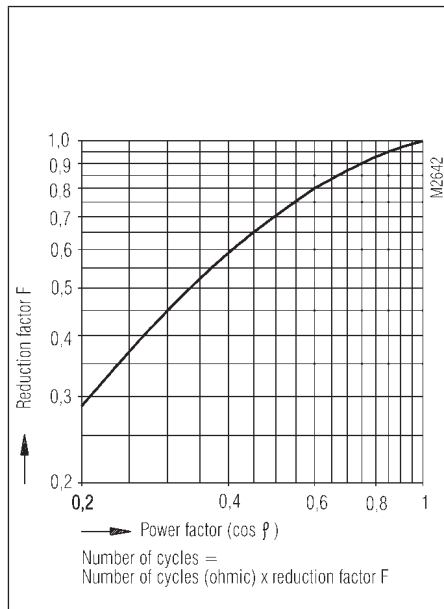
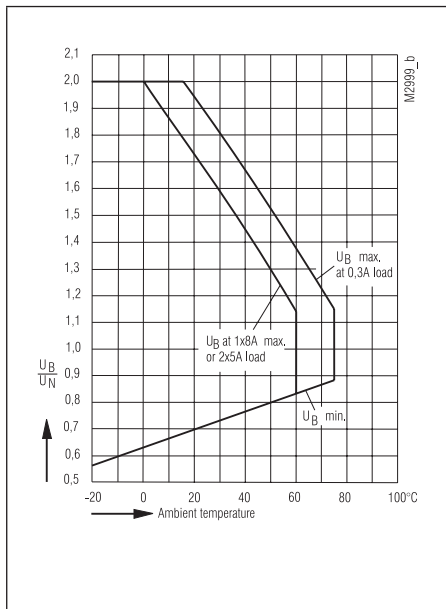

Drilling plan (solder side)

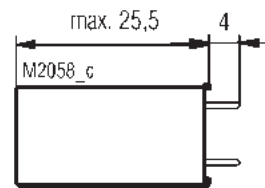
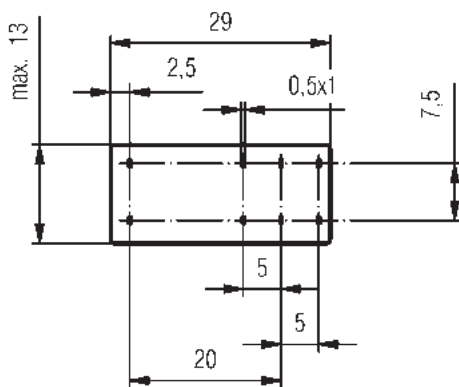
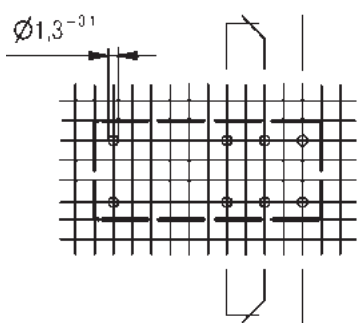

M2058\_c  
0A5668.12  
0W5668.12

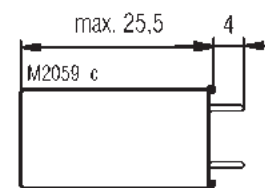
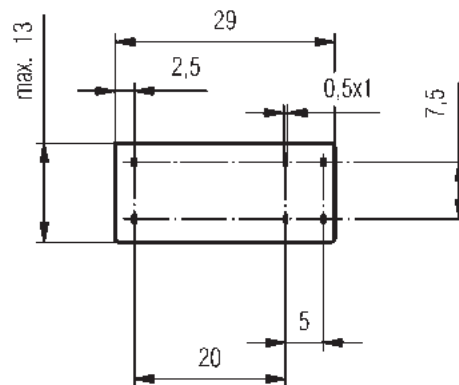
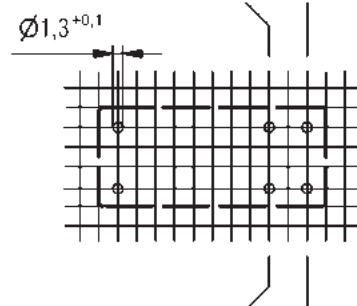

M2059\_c  
0A5668.02  
0W5668.02

Connection for basic grid dimensions 2.5 mm as well as 2.54 mm according to IEC/EN 60097 and IEC 60326 average

Accessories

Socket ET 1415.021 Fixing clip ET 1415.025	Socket ET 1415.041	Socket ET 1415.044	Socket ET 1415.047
	<ul style="list-style-type: none"> <li>Socket for DIN-rail</li> <li>incl. fixing clip</li> </ul>	<ul style="list-style-type: none"> <li>Socket for DIN-rail</li> <li>incl. fixing clip</li> <li>incl. safe separation between coil and contacts according to DIN EN 60947-1, DIN EN 61140, DIN EN 60204</li> </ul>	
	<p>Fixing clip</p> <p>Function module</p> <p>Socket</p> <p>Screw terminals</p>	<p>Fixing clip</p> <p>Function module</p> <p>Socket</p> <p>Screw terminals</p>	<p>Fixing clip</p> <p>Function module</p> <p>Socket</p> <p>Cage clamp terminals</p>
<p>Article number: 0034769</p>	<p>Article number: 0055571</p>	<p>Article number: 0059274</p>	<p>Article number: 0059270</p>
<p>Fixing clip (wire): 0034770 Fixing clip (plastic): 0047726</p>	<p><b>Function modules</b></p> <p><b>ET1415.913:</b> DC 24 V, with free-wheel diode and green LED Article number: 0056828  <b>ET1415.911:</b> DC 24 V, with free-wheel diode and red LED Article number: 0055909  <b>ET1415.924:</b> DC 60 V, with free-wheel diode and red LED Article number: 0062552  <b>ET1415.912:</b> AC/DC 24 V, with varistor and green LED Article number: 0055910</p>		

## Printed Circuit Board Relay

bistable

OB 5693, OB 5694

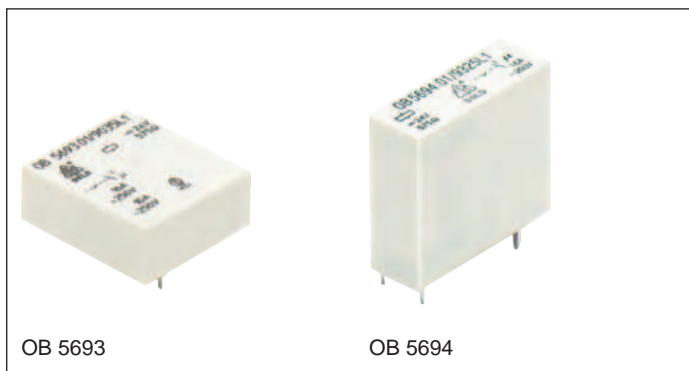

- According to DIN EN 61810-1, IEC/EN 60669-1
- Switching reliability according to IEC/EN 60669-2-2
- Safe separation according to IEC/EN 61140, IEC/EN 60335
- OB 5693: horizontal model
- OB 5694: vertical model
- Bistable, mechanical latching of contact
- For impulse operation, at failure operation 100 % ED possible
- Same pulse (energy and direction) for both switching positions
- AC and DC - model
- Patent on function principle
- On request wash proof

### Application

- Remote switch
- Switching of sockets

### Technical Data

#### Relay type

##### 1.0 Coil

1.1	Nominal voltage	AC V	12, 24, 42, 230	50/60 Hz
		DC V	6, 12, 15, 24, 48, 60, 110	
1.2	Nominal consumption	W / VA	1 / 1.4	

##### 2.0 Contacts

2.1	Contact arrangement	1 changeover contact or 1 NO		
2.2	Contact material	AgSnO <sub>2</sub> ; AgNi		
2.3	Rated insulation voltage	AC V	250	
	Switching voltage min./max.	V	10 / 400	
2.4	Limiting continuous current I <sub>th</sub>	A	16	
	Switching current min./max.	A	10 mA <sup>1)</sup> / 50 (20 ms)	
2.5	Switching power min./max.	VA	3 / 4000	
	Switching power min./max.	W	35 / 300	
	Incandescent lamp load	W	1500	
2.7	Electrical life	switching cycles	at 1 s On, 1 s Off (see contact service life)	
	at AC 250 V 16 A cos φ = 1	switching cycles	≥ 5 x 10 <sup>4</sup>	
2.8	max. switching frequency	switching cycles / s	5	
2.10	Contact force	cN	≥ 8	
2.14	Contact gap	mm	≥ 0.5	

##### 3.0 Other

3.1	Mechanical life	switching cycles	DC ≥ 10 x 10 <sup>6</sup> , AC ≥ 1 x 10 <sup>5</sup>	
3.2	Temperature range	°C	- 40 ... + 75	
3.3	Degree of protection	Solder line proof RT II		
3.5	Vibration resistance	5 g, bis max. 100 Hz		
3.6	Climate resistance	25 / 050 / 04 (climate category); A / B / D IEC/EN 60068-1		

If no limit values stated the above values are typical values for the mean value.

All values are related to 20°C and for new products.

<sup>1)</sup> Typical values <sup>2)</sup> Only valid for the stated temperature range (≅ EN 61 810) different values (derating) see operating voltage limit curve



## Technical Data

3.8	Insulation according to IEC 60664-1		
	Rated insulation voltage	AC V	250
	Pollution degree		3
	Overvoltage category		III
	Test voltage		
	contact-coil (1 min)	AC kV eff.	≥ 4
	Transient voltage		
	contact-coil (1.2 - 50 μs)	kV	≥ 6
	Clearance and creepage distances		
	contact-coil	mm	≥ 8
3.9	Weight	g	approx. 15
<b>4.0 Packing</b>			
4.1	on cardboard	Stück	OB 5693: 32; OB 5694: 56
4.2	in case package	Stück	OB 5693: 320; OB 5694: 280
<b>5.0 Solder method</b>			
5.1	Solder method /-temperature /-duration	°C / s	Wafer soldering / 260 / 5

## Design Version OB 5693

Nominal voltage U <sub>N</sub>		Voltage range <sup>2)</sup> V	Resistance Ω (±10%)	AgSnO <sub>2</sub>		Ag Ni + 0.2 μm Au	
DC V	AC V			.01/	.11/	.01/	.11/
6		4.8 ... 6.6	38	9031	9001	9141	9121
12		9.6 ... 13.2	150	9032	9002	9142	9122
15		12 ... 16.5	220	9033	9003	9143	9123
20		16 ... 22	410	9034	9004	9144	9124
24		19.2 ... 26.4	575	9035	9005	9145	9125
48		38.4 ... 52.8	2 500	9036	9006	9146	9126
60		48 ... 66	3 600	9037	9007	9147	9127
110		88 ... 121	12 100	9038	9008	9148	9128
	12	9.6 ... 13.2	65	9182	9152	9232	9222
	24	19.2 ... 26.4	250	9181	9151	9231	9221
	42	33.6 ... 46.2	830	9183	9153	9233	9223
	230	184 ... 253	25 000	9187	9157	9235	9225

## Design Version OB 5694

Nominal voltage U <sub>N</sub>		Voltage range <sup>2)</sup> V	Resistance Ω (±10%)	AgSnO <sub>2</sub>		Ag Ni + 0.2 μm Au	
DC V	AC V			.01/	.11/	.01/	.11/
6		4.8 ... 6.6	38	9321	9301	9331	9311
12		9.6 ... 13.2	150	9322	9302	9332	9312
15		12 ... 16.5	220	9323	9303	9333	9313
20		16 ... 22	410	9324	9304	9334	9314
24		19.2 ... 26.4	575	9325	9305	9335	9315
	12	9.6 ... 13.2	65	9422	9402	9432	9412
	24	19.2 ... 26.4	250	9423	9403	9433	9413
	42	33.6 ... 46.2	830	9424	9404	9434	9414
	230	184 ... 253	25 000	9425	9405	9435	9415

## Ordering Example

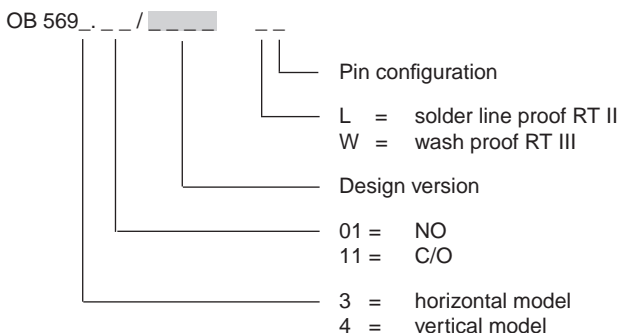

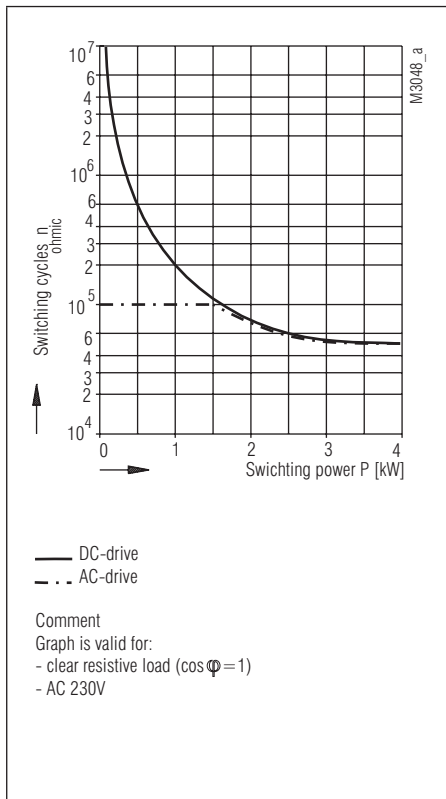

Contact service life

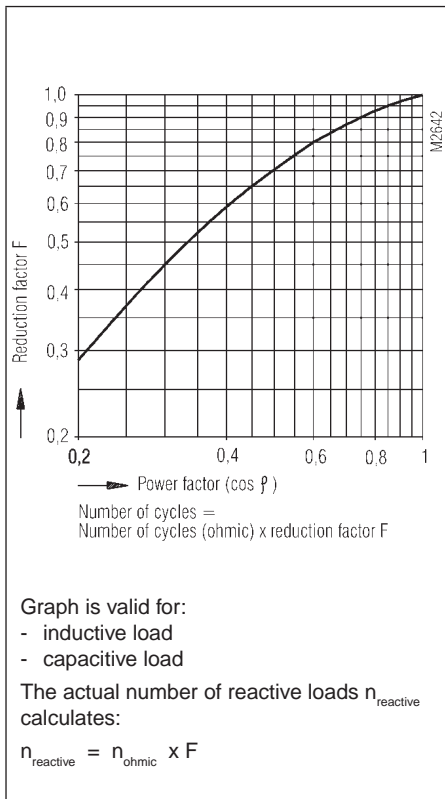

Reduction factor for reactive loads

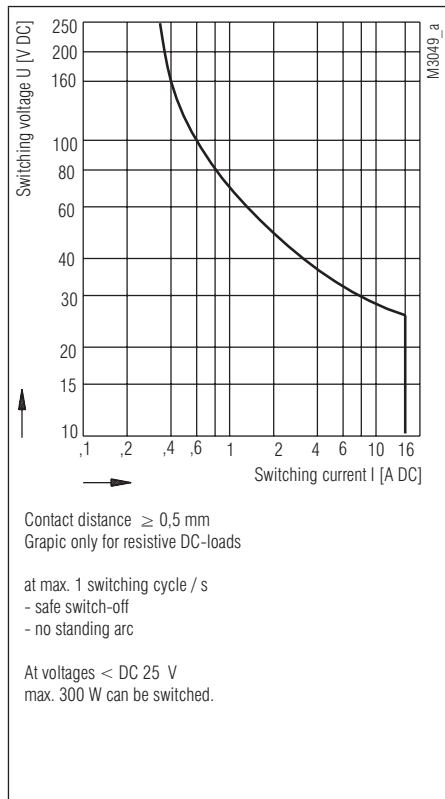

Limit curve for arc-free operation

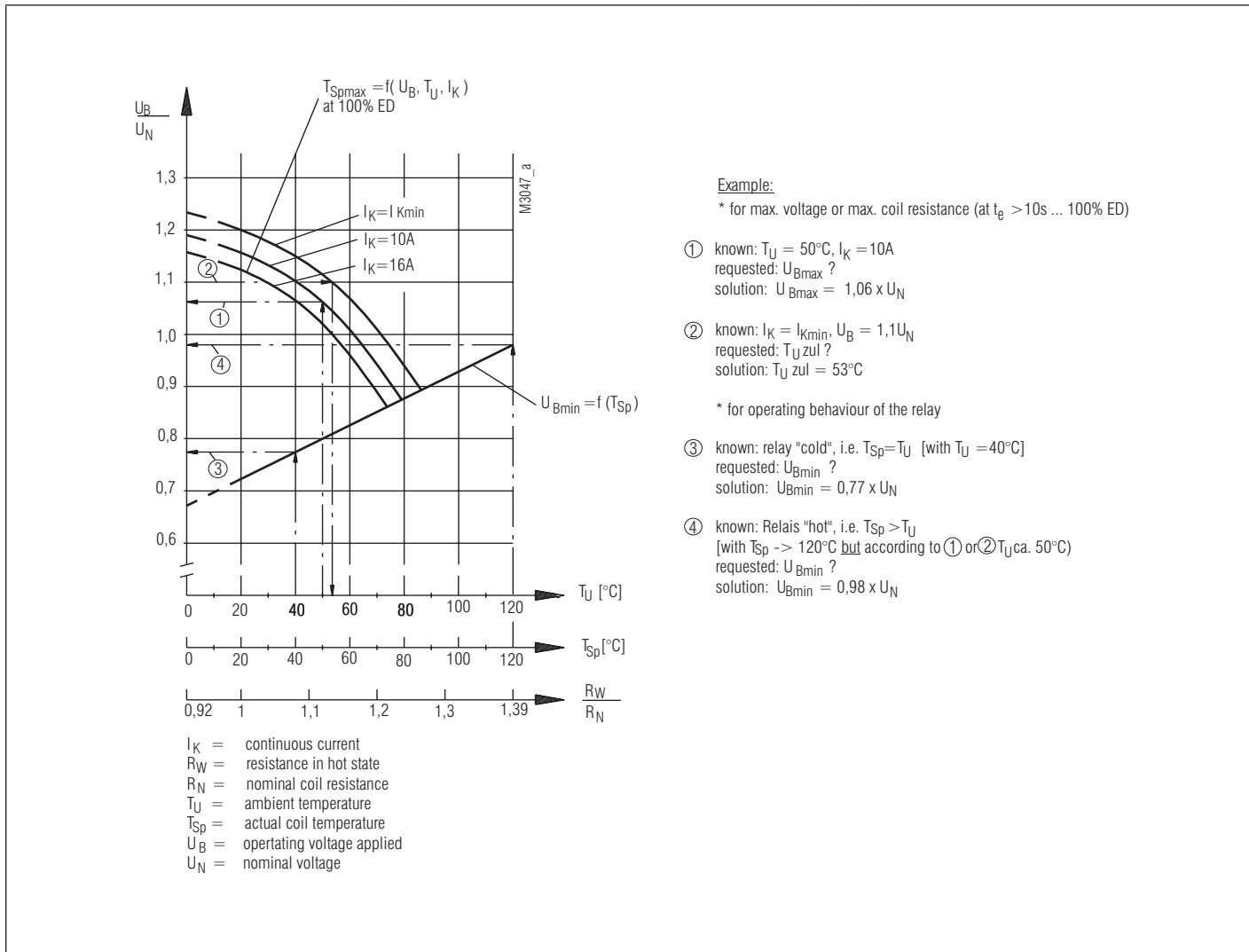

Operating voltage limit curve

## Function Diagram

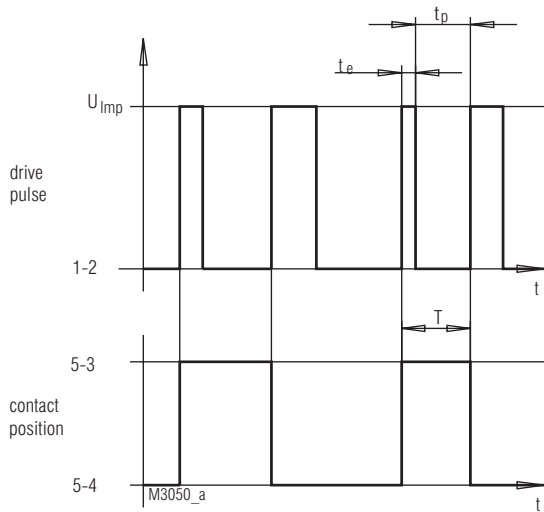

Notes:

1.) Safe function for pulse operation  
at  $0,8 \times U_N < U_{imp} < 1,1 \times U_N$

$t_{e \text{ min}} = 20 \text{ ms}$   
 $t_{p \text{ min}} = 180 \text{ ms}$

2.) Safe thermal operation  
at  $1,1 \times U_N < U_{imp}$   
(voltage increase at pulse operation)

$$U_{imp} = U_{Bmax} \times \sqrt{\frac{T}{t_e}}$$

with:  $t_e \leq 10 \text{ s}$

for:  $t_e > 10 \text{ s} \dots 100\% \text{ ED}$   
see operating voltage limit curve

## Dimensions, Pin Configuration, Connection Diagrams

### Drilling plan (solder side)

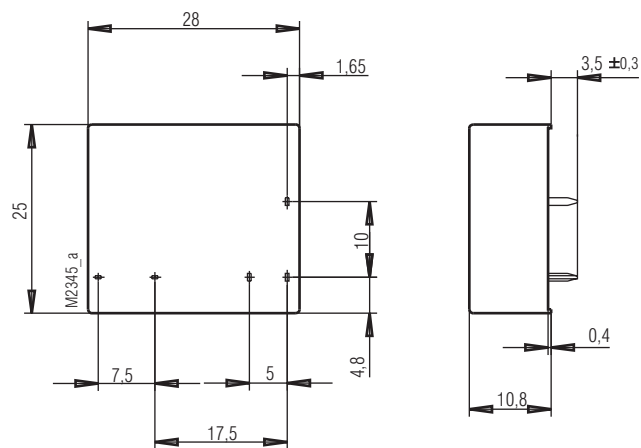
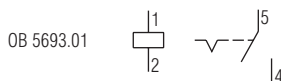
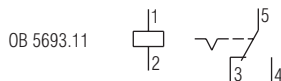
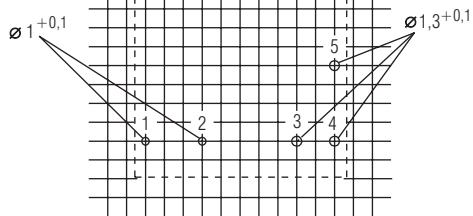
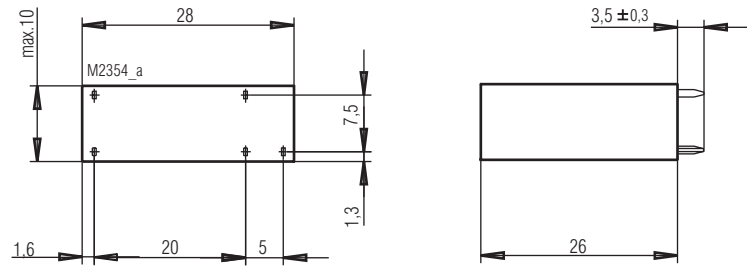
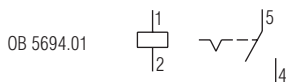
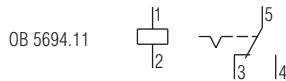
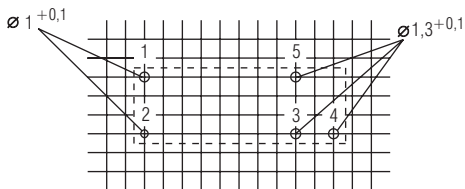

Connection for basic grid dimensions 2.5 mm as well as 2.54 mm according to IEC/EN 60097 and IEC 60326 average



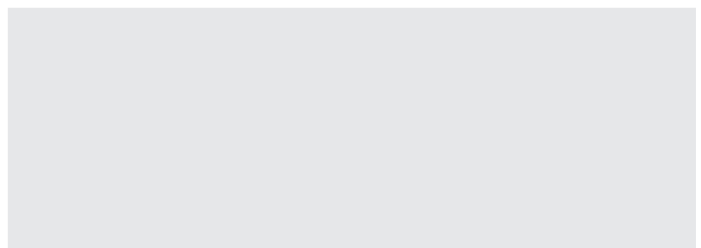
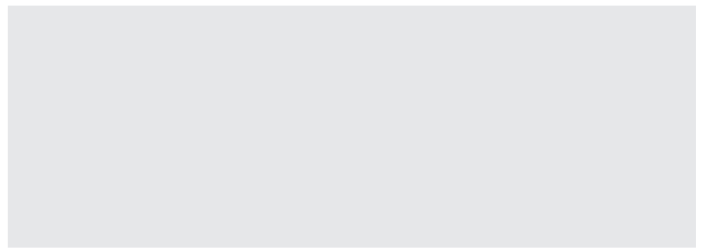

## Miniature relays

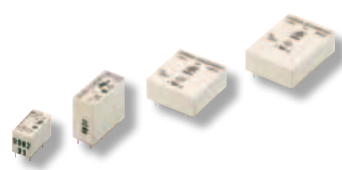

- monostable
- monostable, SMD model
- bistable

## DILAIS

Power Miniature Relay, monostable  
OA 5690

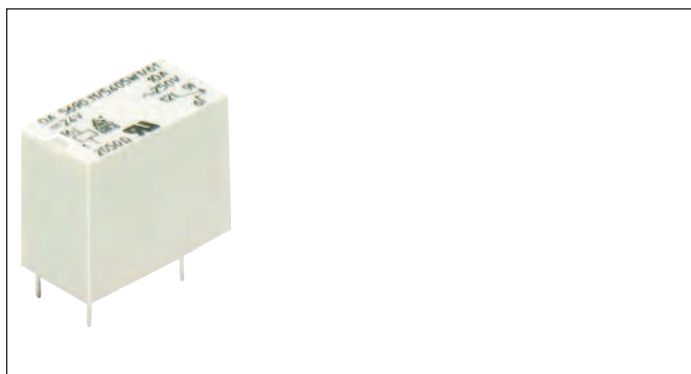

- According to DIN EN 61810-1, IEC 61810-3 resp. DIN EN 50205
- Safe separation according to IEC/EN 60335; IEC/EN 60730
- Clearance and creepage distances:  
contact - coil  $\geq 8$  mm
- Low rated power consumption
- High mechanical service life
- High continuous thermal current
- Large voltage range
- Low mutual capacitance
- High switching power
- Very small volume **DIL model**, can be plugged into standard IC-socket
- Different connection arrangements and contact materials
- Wash proof RT III

### Applications

- Control technique
- Interface

### Approvals and Markings



### Technical Data

Relay type		single contacts (10 A)	single contacts (5 A)
<b>1.0 Relay coil</b>			
1.1 Nominal voltage	DC V	4, 5, 6, 12, 20, 24, 48	
1.2 Nominal consumption			
1 NO contact	mW	160	135
1 changeover contact	mW	280	250
1.11 Voltage range	$U_N$	0.75 ... 1.8	0.75 ... 2.0
1.13 Holding power			
1 NO contact	mW	40	34
1 changeover contact	mW	70	62.5
<b>2.0 Contacts</b>			
single contacts			
2.1 Contact arrangement		1 NO contact, 1 changeover contact	
2.2 Contact material		AgSnO <sub>2</sub> + 0.3 $\mu$ m Au	AgNi + 0.3 $\mu$ m Au <sup>1)</sup>
2.3 Rated insulation voltage	AC V	250	
Switching voltage min./max.	V	AC/DC 10 / DC 120, AC 400 V	
2.4 Limiting continuous current $I_{th}$	A	10	5
Switching current min./max.	A	0.01 <sup>3)</sup> / 10	0.01 <sup>3)</sup> / 5 (1mA/0.3) <sup>2)</sup>
2.5 Switching power min./max.	VA	3 / 2 500	1 / 1 250
Switching power min./max.	W	3 / 120	1 / 120
2.6 Switching capacity to IEC/EN 60947-5-1			
AC 15	AC V/A	NC: 230 / 2    NO: 230 / 5	
2.7 Electrical life		at 1 s On, 1 s Off (see contacts service life)	
at AC 230 V, 5 A, $\cos\phi = 1$	switching cycles	1 x 10 <sup>5</sup>	
at AC 230 V, 10 A, $\cos\phi = 1$	switching cycles	1 x 10 <sup>5</sup>	
2.8 Switching frequency max.	switching cycles/s	20	
2.9 Pick-up / Reset time	ms	$\leq 6$ (typically 4.5) / $\leq 5$ (typically 3)	
2.10 Contact force	cN	NC approx. 8; NO approx. 10	
2.14 Contact gap	mm	$\geq 0.3$	
<b>3.0 Other</b>			
3.1 Mechanical life	switching cycles	$> 50 \times 10^6$	
3.2 Temperature range	$^{\circ}$ C	- 40 ... + 80	
3.3 Degree of protection, housing		Wash proof RT III	
3.5 Vibration resistance		10 ... 55 Hz; 1.2 mm amplitude; 10 g max. IEC/EN 60068-2-6	
3.6 Climate resistance		20 / 065 / 04 (climate category); A/B/D IEC/EN 60068-1	

<sup>1)</sup> as option AgNi + 5  $\mu$ m Au

<sup>2)</sup> Values for AgNi 0.15 + 5  $\mu$ m Au

<sup>3)</sup> Typical values

## Technical Data

3.8	Insulation acc. to IEC 60664-1			
	Rated insulation voltage	AC V		250
	Pollution degree			3
	Overvoltage category			III
	Test voltage			
	Contact-coil (1 min)	AC kV eff.		≥ 4
	Clearance and creepage distances			
	Contact- Coil	mm		≥ 8 IEC/EN 60730, IEC/EN 60335
3.9	Weight	g		4
<b>4.0 Packing</b>				
4.1	on cardboard	piece		100
4.2	in case package	piece		800
<b>5.0 Solder method</b>				
5.1	Solder method /-temperature /-duration	°C / s		Wafer soldering / 260 / 5

## Design Versions

Standard variant for switching current max. I = 5 A

U <sub>N</sub> V =	Resistance at 20°C Ω ± 10%		OA 5690 AgNi + 0,3 μm Au	
	1 S	1 W	.01/	.11/
4,5	155	78	5461	5441
6	315	155	5462	5442
12	1070	600	5463	5443
20	2960	1600	5464	5444
24	4300	2400	5465	5445
48	-	9200	-	5446

Standard variant for switching current max. I = 10 A

U <sub>N</sub> V =	Resistance at 20°C Ω ± 10%		OA 5690 AgSnO <sub>2</sub> + 0,3 μm Au	
	1 S	1 W	.01/	.11/
4,5	130	78	5421	5401
6	225	130	5422	5402
12	900	510	5423	5403
20	2 400	1 450	5424	5404
24	3 600	2 050	5425	5405
48	-	6 560	-	5406

Standard variant with goldplated contacts

U <sub>N</sub> V =	Resistance at 20°C Ω ± 10%		OA 5690 AgNi + 5 μm Au	
	1 S	1 W	.01/	.11/
4,5	155	78	5511	5491
6	315	155	5512	5492
12	1070	600	5513	5493
20	2960	1600	5514	5494
24	4300	2400	5515	5495
48	-	9200	-	5496

## Ordering Example

OA 5690 . . . / . . . W\_ / 61\*)

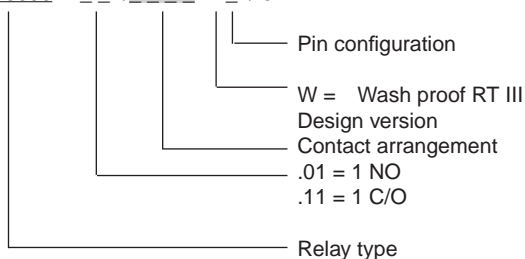

\*) /61 cURus approval

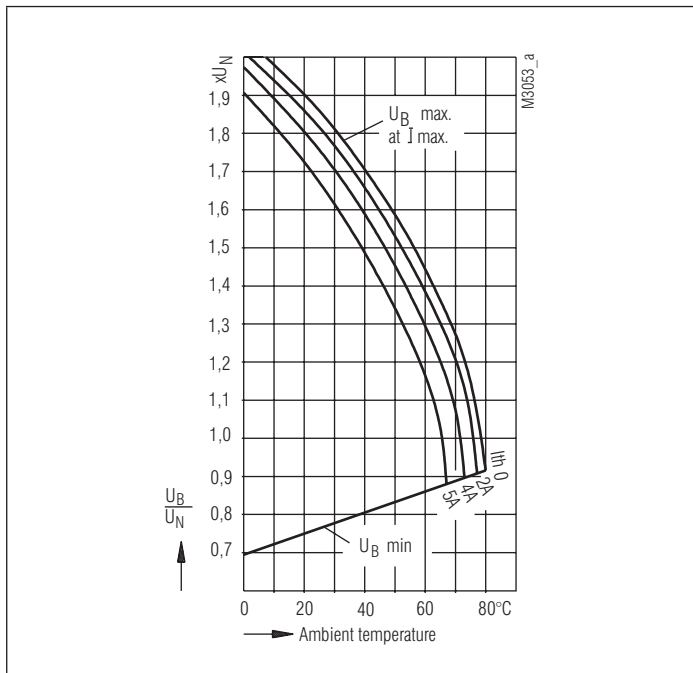

Operating voltage limit curve  
OA 5690.11 5 A - model

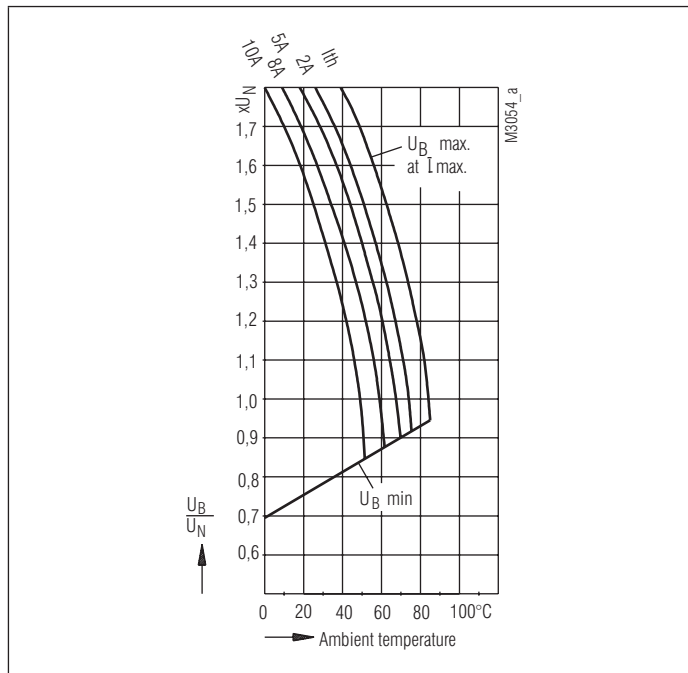

Operating voltage limit curve  
OA 5690.11 10 A - model

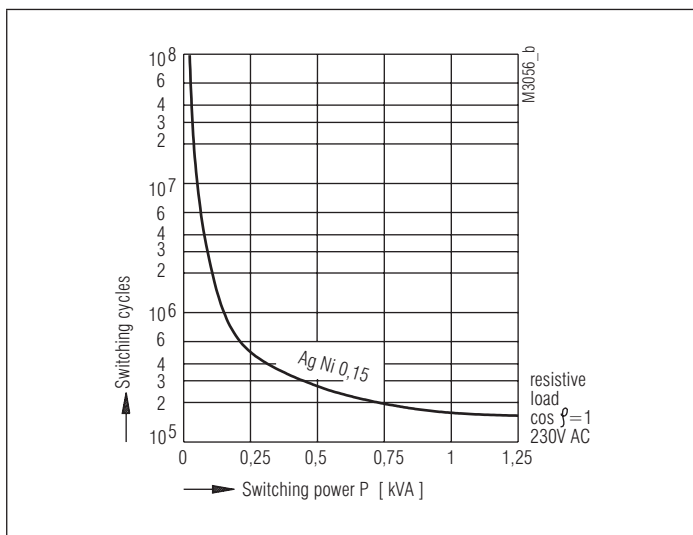

Contact service life OA 5690.11 5 A - model

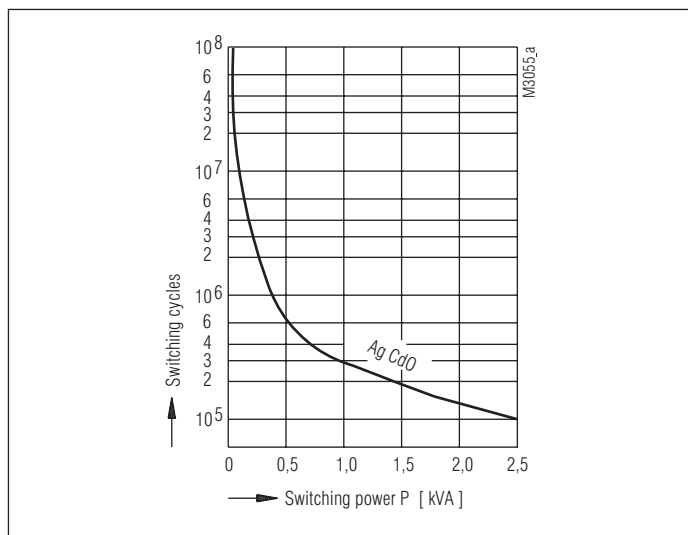

Contact service life OA 5690.11 10 A - model

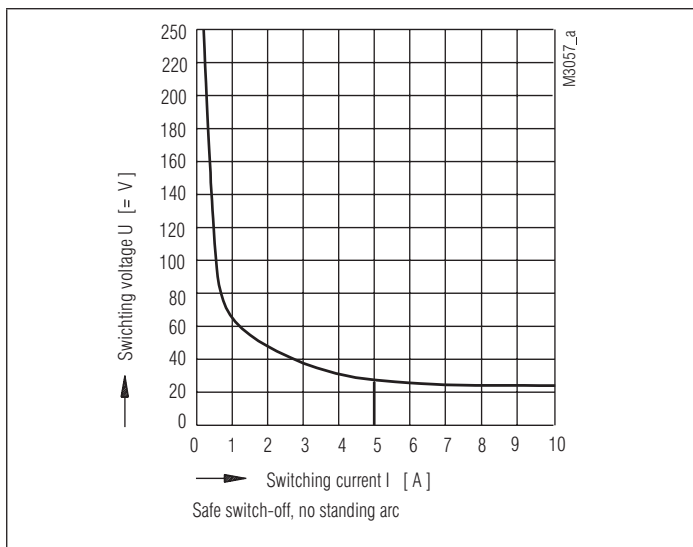

Limit curve for arc-free operation

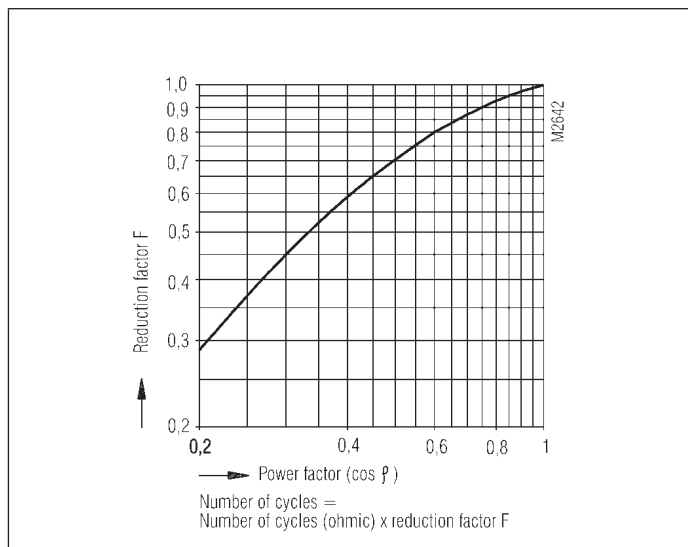

Reduction factor for inductive loads



Drilling plan (solder side)  
Pin variant 1, pin compatible to OW 5699

OA 5690.11 / \_ \_ \_ \_ \_ 1

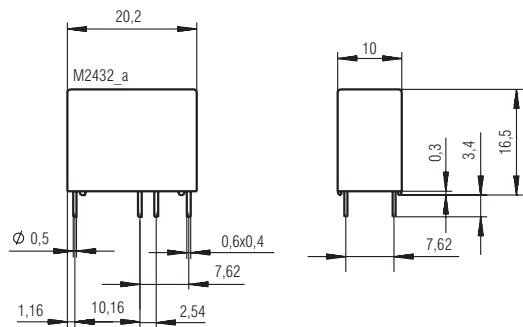

OA 5690.01 / \_ \_ \_ \_ \_ 1

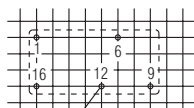
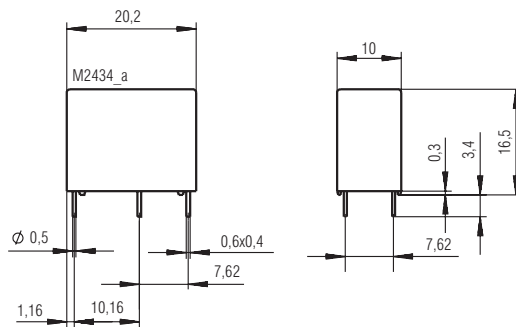

$\varnothing 0,8^{+0,1}$

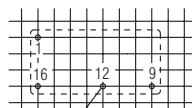
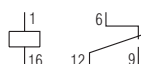

$\varnothing 0,8^{+0,1}$

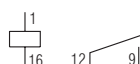

Pin variant 2, pin compatible to OW 5691

OA 5690.11 / \_ \_ \_ \_ \_ 2

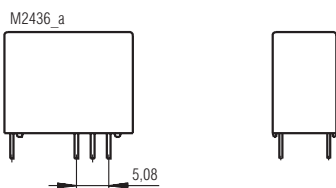

OA 5690.01 / \_ \_ \_ \_ \_ 2

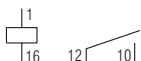
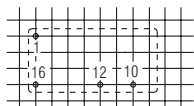
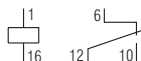
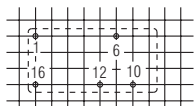
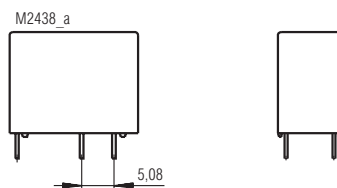

Pin variant 3, pin compatible to various competitors relays

OA 5690.11 / \_ \_ \_ \_ \_ 3

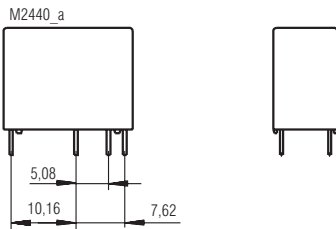

OA 5690.01 / \_ \_ \_ \_ \_ 3

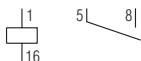
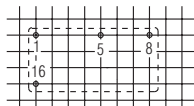
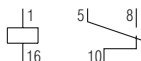
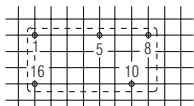
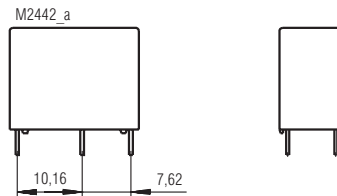

Connections for basic grid dimensions 2,5 mm as well as 2,54 mm according to IEC/EN 60 097 and IEC 60 326 average.  
Pin distance tolerance measured at the pin ends  $\pm 0.3$  mm. Dimensions are valid for untinned state.

## DILAIS

Power Miniature Relay, bistabil  
OB 5690

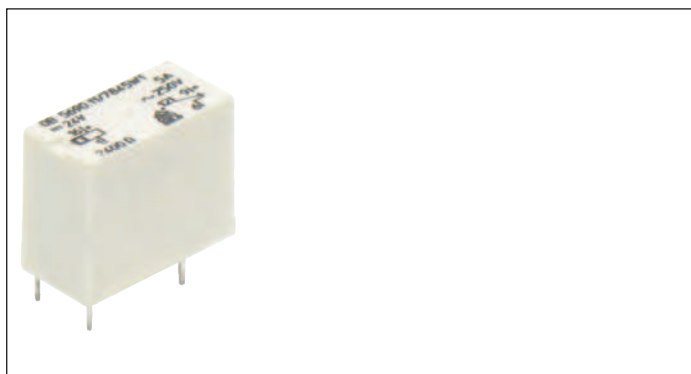

- According to DIN EN 61810-1, DIN EN 60664-1
- Safe separation according to IEC/EN 60730; IEC/EN 60335
- Poled
- Clearance and creepage distances:  
contact - coil  $\geq 8$  mm
- Low rated power consumption
- High voltage resistance  $\geq 4$  kV
- High mechanical service life
- High continuous thermal current
- For pulse operation, continuous operation permitted
- Large voltage range
- Very low mutual capacitance
- High switching power
- Very small volume **DIL model**, can be plugged into standard IC-socket
- Different connection arrangements and contact materials
- Wash proof RT III

### Applications

- Control technique
- Interface

### Technical Data

Relay type		OB 5690
<b>1.0 Relay coil</b>		
1.1 Nominal voltage	DC V	4, 5, 6, 12, 20, 24, 48
1.2 Nominal consumption 1 changeover contact	mW	250
1.11 Voltage range	$U_N$	0.75 ... 1.9
<b>2.0 Contacts</b>		
2.1 Contact arrangement		1 NO, 1 changeover contact
2.2 Contact material		AgSnO <sub>2</sub> + 0.3 $\mu$ m Au; AgNi + 0.3 $\mu$ m Au <sup>1)</sup> ; 3 $\mu$ m Au on request
2.3 Rated insulation voltage	AC V	250
Switching voltage min./max.	V	AC/DC 10 / DC 120, AC 400
2.4 Limiting continuous current $I_{th}$	A	5 (see operating voltage limit curve)
Switching current min./max.	A	0.01 <sup>2)</sup> / 5
2.5 Switching power min./max.	VA	0.1 / 1250
Switching power min./max.	W	0.1 / 120
2.6 Switching capacity to IEC/EN 60947-5-1 AC 15	AC V/A	NC: 230 / 1 NO: 230 / 5
2.7 Electrical life at AC 230 V 5 A $\cos \varphi=1$	switching cycles switching cycles	at 1 s On, 1 s Off (see contact service life) 1 x 10 <sup>5</sup>
2.9 Response time / Release time	ms	$\leq 5$ (typically 3) / $\leq 4$ (typically 2)
2.10 Contact force NC / NO	cN	approx. 10 / approx. 8
2.14 Contact gap	mm	$\geq 0.3$
<b>3.0 Other</b>		
3.1 Mechanical life	switching cycles	$> 50 \times 10^6$
3.2 Temperature range	$^{\circ}$ C	- 40 ... + 80
3.3 Degree of protection		Wash proof RT III
3.5 Vibration resistance		10 ... 55 Hz; 1.2 mm amplitude; 10 g max. IEC/EN 60068-2-6
3.6 Climate resistance		20 / 080 / 04 (climate category); A/B/D IEC/EN 60068-1
3.8 Insulation according to IEC 60664-1		
Rated insulation voltage	AC V	250
Pollution degree		3
Overvoltage category		III
Test voltage		
Contact - coil (1 min)	AC kV eff.	$\geq 4$
Clearance and creepage distances		
Contact- Coil	mm	$\geq 8$ IEC/EN 60730, IEC/EN 60335
3.9 Weight	g	approx. 6
<b>4.0 Packing</b>		
4.1 on cardboard in slipcase	piece	100
4.2 in case package	piece	800
<b>5.0 Solder method</b>		
5.1 Solder method /-temperature /-duration	$^{\circ}$ C / s	Wafe soldering / 260 / 5

<sup>1)</sup> on request: AgSnO<sub>2</sub> + 0.3  $\mu$ m Au

<sup>2)</sup> Typical values

## Design Versions

U <sub>N</sub> DC V	Voltage range DC V	Resistance at 20°C Ω	OB 5690.01/...		OB 5690.11/...	
			AgSnO <sub>2</sub>	AgNi 0.15	AgSnO <sub>2</sub>	AgNi 0.15
4.5	3.3 ... 9.9	80	7831 W	7851 W	7821 W	7841 W
6	4.5 ... 13.2	150	7832 W	7852 W	7822 W	7842 W
12	9.0 ... 26.4	585	7833 W	7853 W	7823 W	7843 W
20	15.0 ... 44.0	1 650	7834 W	7854 W	7824 W	7844 W
24	18.0 ... 52.8	2 400	7835 W	7855 W	7825 W	7845 W
48	36.0 ... 105.0	9 160	7836 W	7856 W	7826 W	7846 W

## Characteristics

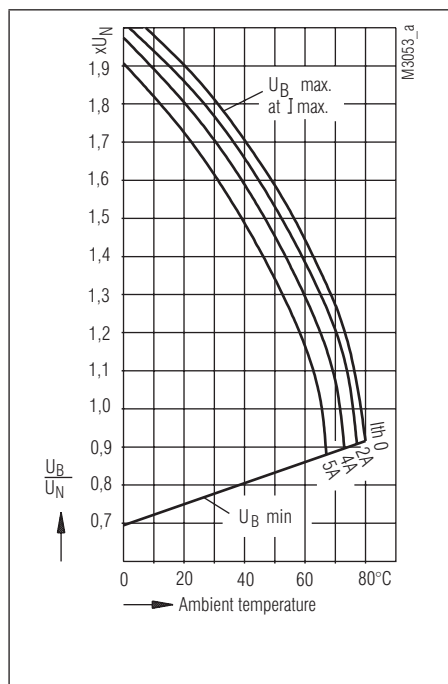

Operating voltage limit curve

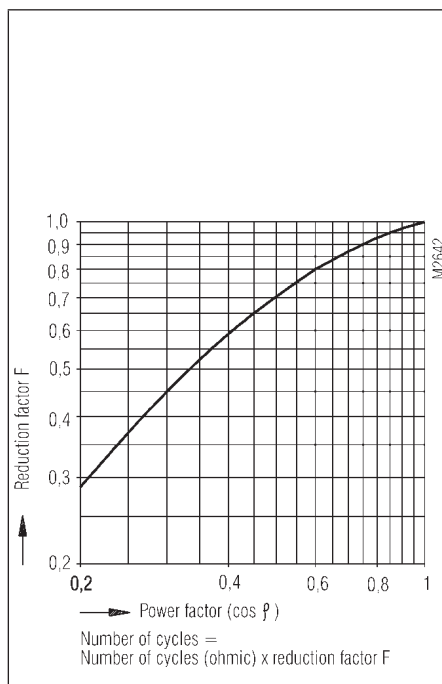

Reduction factor for inductive loads

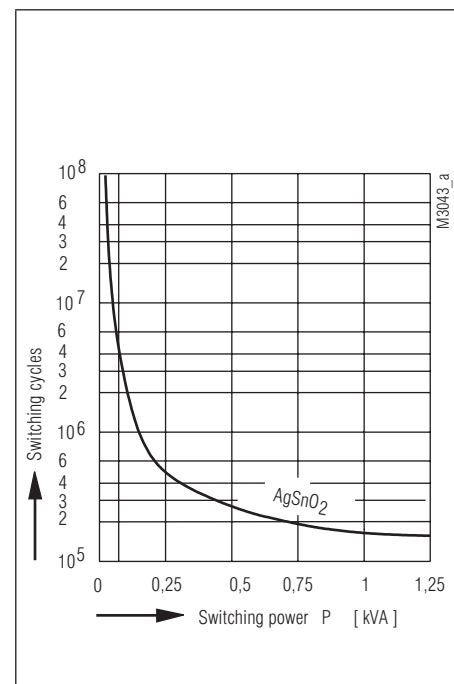

Contact service life (at  $t_u = 20^\circ\text{C}$ )

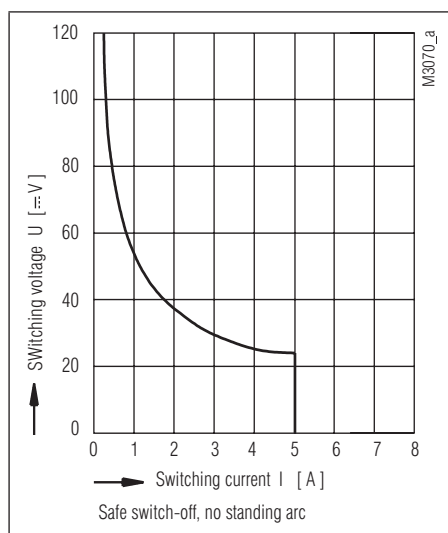

Limit curve for arc-free operation  
(load limit curve)

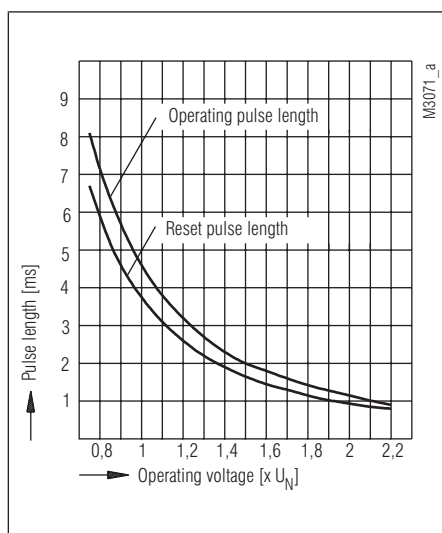

Operating / Reset pulse length

## Ordering Example

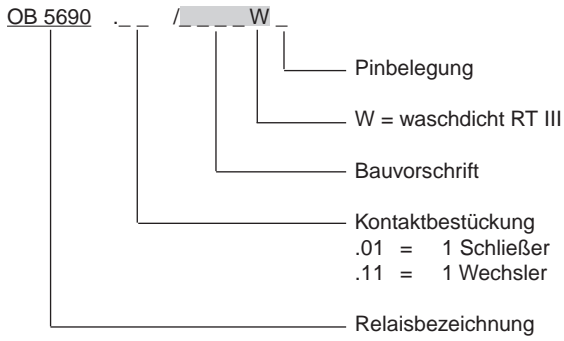

## Dimensions, Pin Configuration, Connection Diagrams

### Drilling plan (solder side)

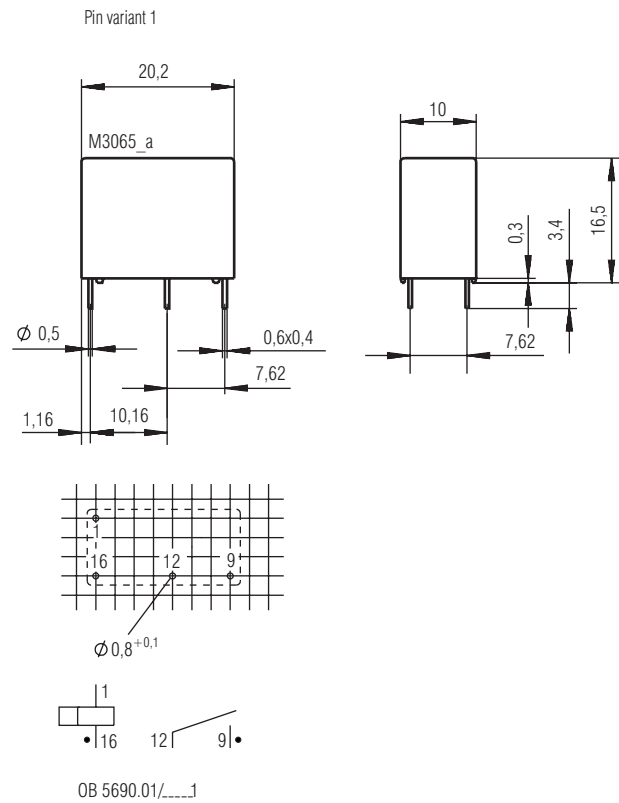
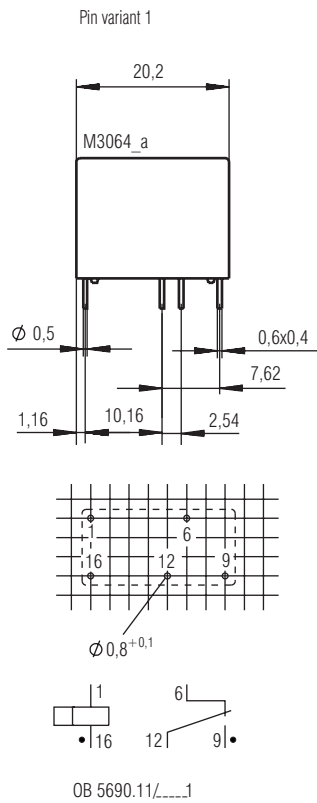

Connections for basic grid dimensions 2,5 mm as well as 2,54 mm according to IEC/EN 60 097 and IEC 60 326 average.  
Pin distance tolerance measured at the pin ends  $\pm 0,3$  mm. Dimensions are valid for untinned state.

Drilling plan (solder side)

Pin variant 2

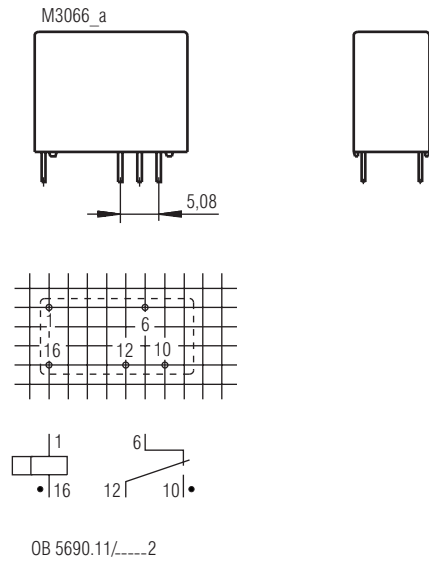

Pin variant 2

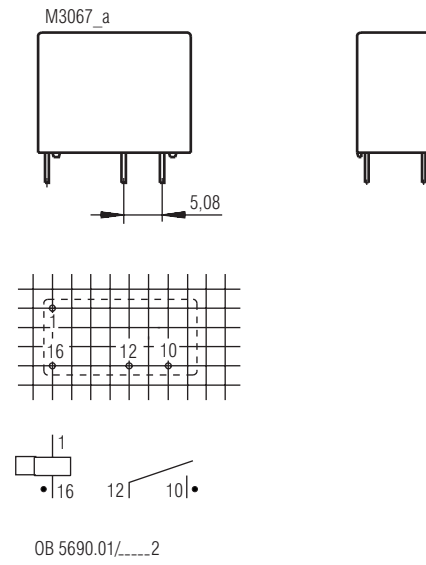

Pin variant 3

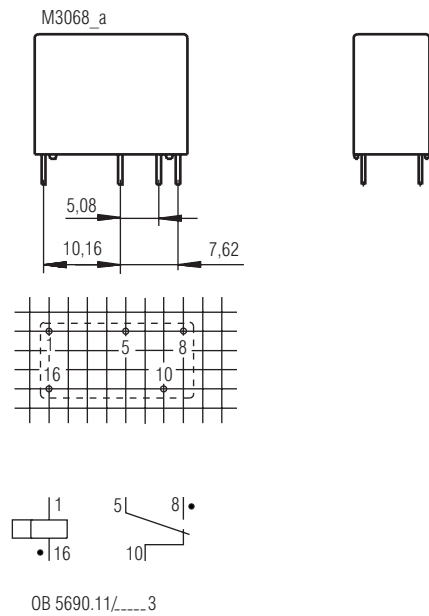

Pin variant 3

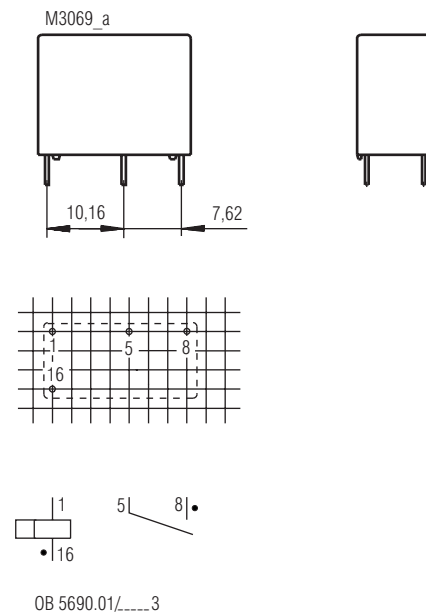

Connections for basic grid dimensions 2,5 mm as well as 2,54 mm according to IEC/EN 60 097 and IEC 60 326 average.  
Pin distance tolerance measured at the pin ends  $\pm 0.3$  mm. Dimensions are valid for untinned state.

## DILAIS

Power Miniature Relays, monostable  
OW 5691, OW 5699



- According to DIN EN 61810-1, DIN EN 60664-1
- Clearance and creepage distances:  
Contact - coil  $\geq 8$  mm
- Low rated power consumption
- High dielectric strength  $\geq 4$  kV
- High mechanical service life
- High switching power
- High thermal continuous current
- Large voltage range
- Very small volume **DIL model**, can be plugged into standard IC-Sockets
- Different connection arrangements and contact materials
- Wash proof RT III

### Applications

- Control technique
- White goods

### Approvals and Markings



### Technical Data

Relay type	OW 5691 / OW 5699		OW 5699
<b>1.0 Relay coil</b>			
1.1 Nominal voltage	DC V	4, 5, 6, 12, 20, 24, 48	
1.2 Nominal consumption	mW	see table Technical Data	
1.11 Voltage range	$U_N$	0.75 ... 2.2	0.75 ... 1.6
1.13 Holding power	mW	see table Technical Data	
<b>2.0 Contacts</b>			
2.1 Contact arrangement	1 NO, 1 changeover contact		
2.2 Contact material	AgNi + 0.3 $\mu$ m Au <sup>1)</sup> ; optionally 3 $\mu$ m Au		
2.3 Rated insulation voltage	AC V	250	
Switching voltage min./max.	V	AC/DC 10 / DC 120, AC 250	
2.4 Limiting continuous current $I_{th}$	A	5	8
Switching current min./max.	A	0.01 <sup>2)</sup> / 5	0.01 <sup>2)</sup> / 8
2.5 Switching power min./max.	VA	0.1 / 1 250	0.1 / 2 000
Switching power min./max.	W	0.1 / 120	0.1 / 120
2.6 Switching capacity to IEC/EN 60947-5-1	NC: 230 / 1, NO: 230 / 3		
AC 15	AC V/A		
2.7 Electrical life	at 1 s On, 1 s Off (see contacts service life)		
at AC 230 V 5 A $\cos \varphi=1$	switching cycles	see characteristics of contact service life	
2.9 Response time	ms	( $I_{th}=5$ A) max. 8 (typically 5)	( $I_{th}=8$ A) max 5. (typically 2.2)
Release time	ms	max. 4 (typisch 2)	
Bouncing time (NC)		max. 10 (typically 6)	max. 8 (typically 3.5)
Bouncing time (NO)		( $I_{th}=5$ A) max. 4 (typically 1.5)	( $I_{th}=8$ A) max. 2 (typically 1)
2.10 Contact force	cN	approx. 8	approx. 10
<b>3.0 Other</b>			
3.1 Mechanical life	switching cycles	$\geq 10^8$	
3.2 Temperature range	$^{\circ}$ C	- 40 ... + 80	
3.3 Degree of protection	Wash proof RT III		
3.5 Vibration resistance	10 ... 55 Hz; 1.2 mm amplitude; 10 g max. IEC/EN 60068-2-6		
3.6 Climate resistance	20 / 080 / 04 (climate category); A / B / D IEC/EN 60068-1		

<sup>1)</sup> on request: AgSnO<sub>2</sub> + 0.3  $\mu$ m Au

<sup>2)</sup>Typical values

## Technical Data

3.8	Insulation according to IEC 60664-1		
	Rated insulation voltage	AC V	250
	Pollution degree		3
	Overvoltage category		III
	Test voltage		
	Contact-coil (1 min)	AC kV eff.	≥ 4
	Clearance and creepage distances		
	Contact-coil	mm	≥ 5.5 (safe separation acc. to EN 50178)
3.9	Weight	g	approx. 5
<b>4.0 Packing</b>			
4.1	on cardboard in slipcase	piece	100
4.2	in case package	piece	1000
<b>5.0 Solder method</b>			
5.1	Solder method /-temperature /-duration	°C / s	Wafer soldering / 260 / 5

## Design Versions

### 1 changeover contact

I <sub>th</sub> = 5 A	Nominal voltage U <sub>N</sub>	V DC	4.5	6	12	20	24	48
	Design version	AgNi 0.15	911	912	913	916	914	915
	Type OW 5691.11	Au-Contact	081	082	083	086	084	085
	Design version	AgNi 0.15	171	172	173	176	174	175
	Type OW 5699.11	Au-Contact	191	192	193	196	194	195
	Resistance at 20°C	Ω	78	155	600	1 600	2 400	9 216
	Nominal consumption	mW	260	233	240	250	240	250
	Holding power	mW	65	58	60	62.5	60	62.5
Response voltage	V DC	3.3	4.5	9	14.5	17.5	36	
I <sub>th</sub> = 8 A	Design version	AgSnO <sub>2</sub>	201	202	203	204	205	206
	Type OW 5699.11							
	Resistance at 20°C	Ω	65	115	465	1 250	1 860	6 310
	Nominal consumption	mW	311	313	310	320	310	365
	Holding power	mW	77.75	78.25	77.5	80	77.5	91.25
Response voltage	V DC	3.3	4.5	9	15	18	36	

### 1 NO contact

I <sub>th</sub> = 5 A	Nominal voltage U <sub>N</sub>	V DC	4.5	6	12	20	24	48
	Design version	AgNi 0.15	921	922	923	926	924	
	Type OW 5691.01	Au-Contact	091	092	093	096	094	
	Design version	AgNi 0.15	181	182	183	186	184	
	Type OW 5699.01	Au-Contact	231	232	233	236	234	
	Resistance at 20°C	Ω	155	315	1 070	2 960	4 350	
	Nominal consumption	mW	131	114	135	135	132	
	Holding power	mW	32.75	28.5	33.75	33.75	33	
Response voltage	V DC	3	4.3	8	13	16		
I <sub>th</sub> = 8 A	Design version	AgSnO <sub>2</sub>	221	222	223	224	225	226
	Type OW 5699.01							
	Resistance at 20°C	Ω	78	155	600	1 600	2 400	9 200
	Nominal consumption	mW	260	233	240	250	240	250
	Holding power	mW	65	58.25	60	62.5	60	62.5
Response voltage	V DC	3.3	4.5	9	14	17	32	

## Ordering Example

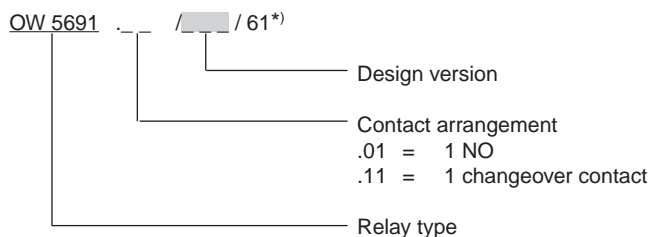

\*) /61 cURus approval

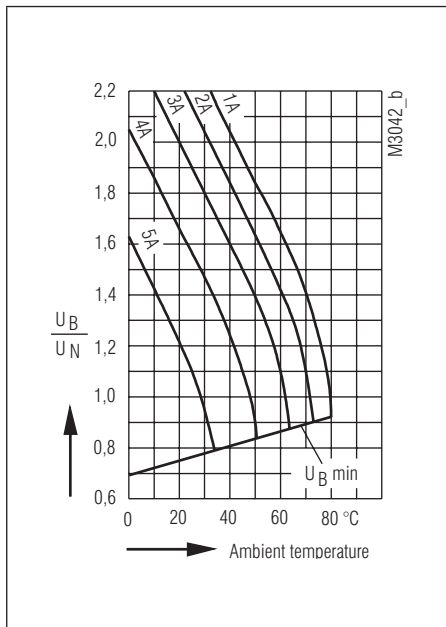

Operating voltage limit curve for OW 5691 and OW 5699 with  $I_{th} \leq 5$  A

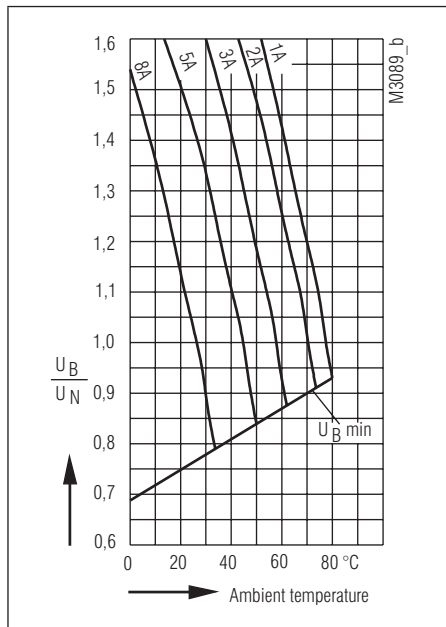

Operating voltage limit curve for OW 5699 with  $I_{th} \leq 8$  A

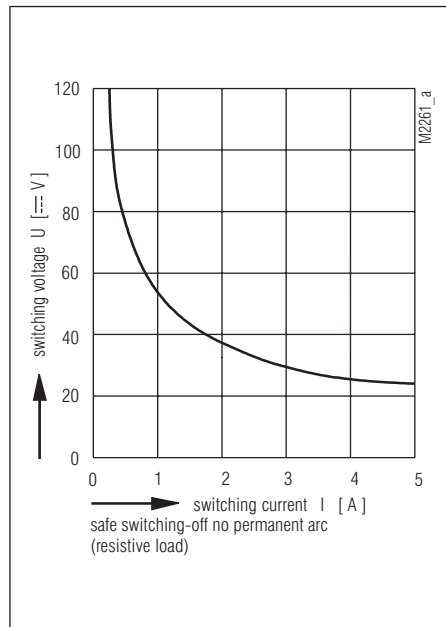

Limit curve for arc-free operation at  $t_v = 20^\circ\text{C}$ ) for OW 5691 and OW 5699

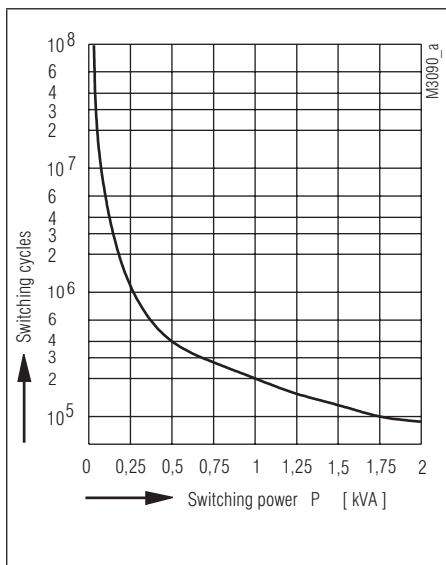

Contact service life for OW 5699 with  $I_{th} \leq 8$  A (NO contact)

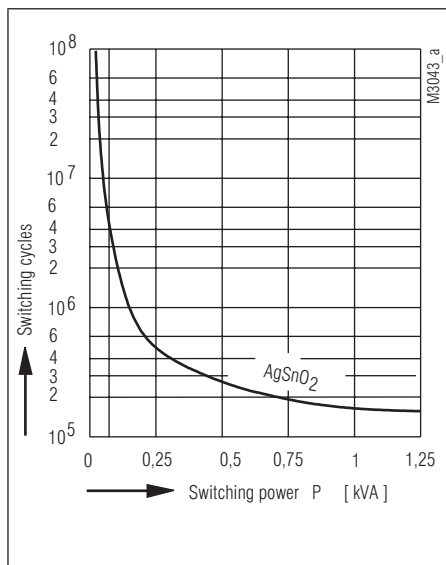

Contact service life for OW 5691 and OW 5699 with  $I_{th} \leq 5$  A (NO contact)

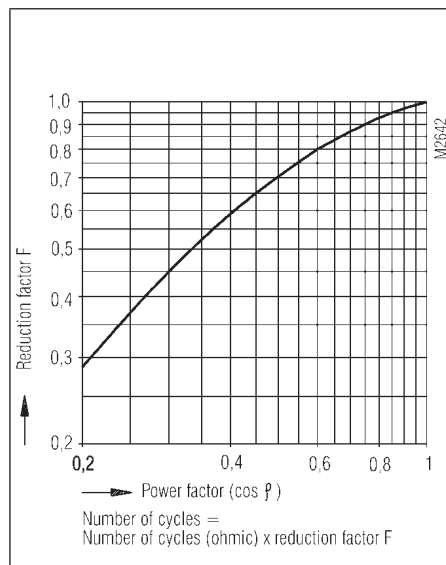

Reduction factor for inductive loads



## Dimensions, Pin Configuration, Connection Diagrams

Pin arrangement (bottom view)

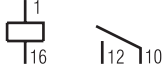
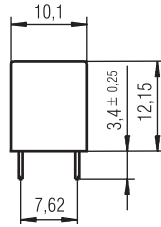
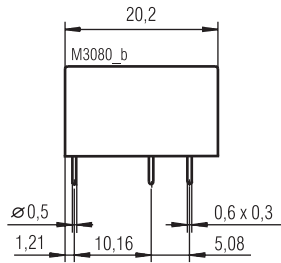
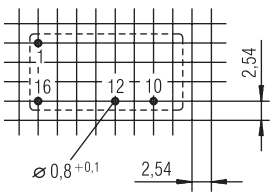

OW 5691.01

Pin arrangement (bottom view)

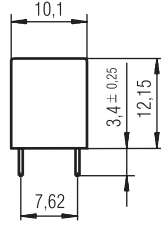
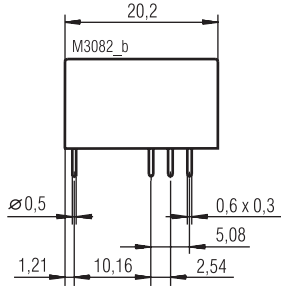
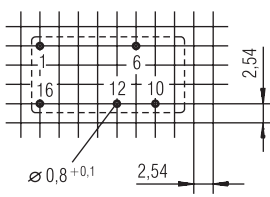

OW 5691.11

Pin arrangement (bottom view)

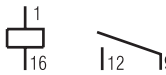
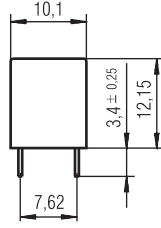
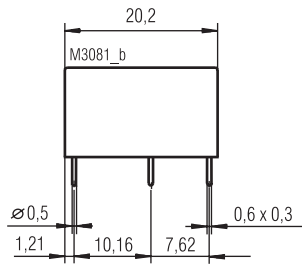
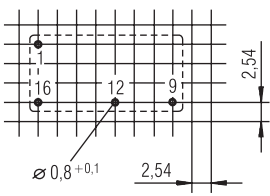

OW 5699.01

Pin arrangement (bottom view)

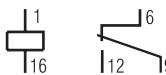
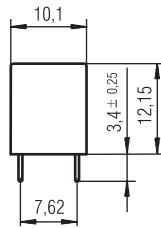
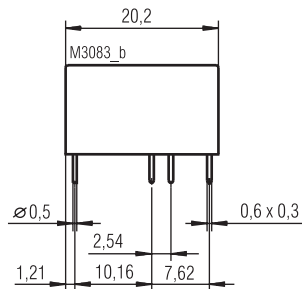
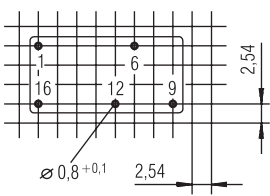

OW 5699.11

Connections for basic grid dimensions 2.5 mm as well as 2.54 mm according to IEC/EN 60 097 and IEC 60 326 average.  
Pin distance tolerance measured at the pin ends  $\pm 0.3$  mm. Dimensions are valid for untinned state.

## DILAIS

Miniature Relais, monostable  
OW 5699, SMD Model

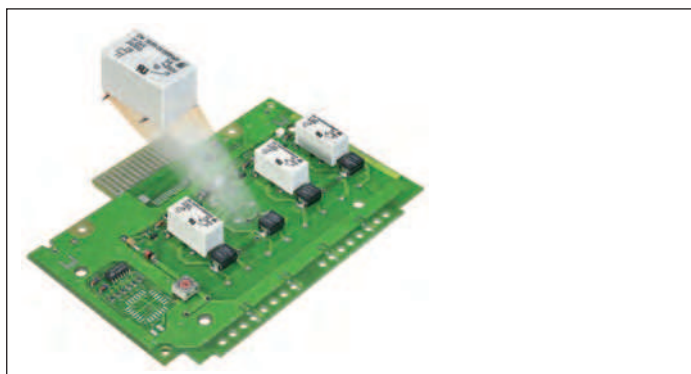

SMT / SMD (Surface Mounting Technology) for Reflow-soldering

- According to DIN EN 61810-1, DIN EN 60664-1
- Clearance and creepage distances:  
Contact - coil  $\geq 5.5$  mm
- Power miniature relay for SMD mounting
- High switching power AC 250 V / 5 A
- High dielectric strength 4 kV
- High limiting continuous current  $I_{th} = 5$  A
- Compact size  $V = 2,47$  cm<sup>3</sup>

### Applications

- Control technique
- Interface

### Approvals and Markings



### Technical Data

Relaistyp		OW 5699
<b>1.0 Relay coil</b>		
1.1 Nominal voltage	DC V	4,5, 6, 12, 20, 24, 48
1.2 Nominal consumption	mW	250 (1 NO), 310 (1 changeover contact)
1.11 Voltage range	$U_N$	0,75 ... 1,6
1.13 Holding power	mW	62,5 (NO) 77,5 (changeover contact)
<b>2.0 Contacts</b>		
2.1 Contact arrangement		1 NO, 1 changeover contact
2.2 Contact material		AgSnO <sub>2</sub> , AgNi <sup>1)</sup>
2.3 Rated insulation voltage	AC V	250
Switching voltage min./max.	V	AC/DC 10 / DC 120, AC 250 <sup>1)</sup>
2.4 Limiting continuous current $I_{th}$	A	5
Switching current min./max.	A	0,01 <sup>2)</sup> / 5
2.5 Switching power min./max.	VA	0,1 / 1 250
Switching power min./max.	W	0,1 / 120
2.6 Switching capacity to IEC/EN 60947-5-1		
AC 15	AC V/A	NC: 230 / 1 NO: 230 / 3
2.7 Electrical life		
at AC 230 V, 1 A, $\cos\phi = 1$	switching cycles	$> 5 \times 10^5$
at AC 230 V, 5 A, $\cos\phi = 1$	switching cycles	$> 1,5 \times 10^5$
2.8 Max. switching frequency	switching cycles/s	20
2.9 Response time / Release time	ms	$\leq 8$ (typ. 5) / $\leq 4$ (typ. 2)
2.10 Contact force	cN	8 (1 NO), 8 (1 changeover contact, NC and NO)
<b>3.0 Other</b>		
3.1 Mechanical life	switching cycles	$\geq 5 \times 10^7$
3.2 Temperature range	°C	- 40 ... + 80
3.3 Degree of protection		Wash proof RT III
3.5 Rüttelfestigkeit		10 ... 55 Hz; 1,2 mm amplitude; 10 g max. IEC/EN 60068-2-6
3.6 Climate resistance		20 / 080 / 04 (climate category); A/B/D IEC/EN 60068-1
3.8 Insulation according to IEC 60664-1		
Rated insulation voltage	AC V	250
Pollution degree		3
Overvoltage category		III
Test voltage		
contact-coil (1 min)	AC kV eff.	$\geq 4$
Clearance and creepage distances	mm	$\geq 5.5$ (safe separation acc. to EN 50178)
3.9 Weight	g	approx. 5
<b>4.0 Packing</b>		
4.1 in palette	piece	100
4.2 in case package	piece	on request
<b>5.0 Solder method</b>		
5.1 Solder method /-temperature /-duration	°C / s	Reflow-convection soldering / 260 / 10

<sup>1)</sup> Special version with gold-contacts with 3  $\mu$ m Au for low loads (0.1 ... 60 V, 1 ... 300 mA) on request

<sup>2)</sup> Typical values

## Design Versions

U <sub>N</sub> (DC V)	Voltage range (DC V)	Resistance at 20°C Ω (±10%)	OW 5699.01/_ _ _	
			AgSnO <sub>2</sub> + 0.3 μm Au	AgNi 0,15 + 0.3 μm Au
4,5	3,0 ... 9,9	78	351	371
6	4,3 ... 13,2	155	352	372
12	8,0 ... 26,4	600	353	373
20	13,0 ... 44,0	1600	354	374
24	16,0 ... 52,8	2400	355	375
48	32,0 ... 105,0	9216	356	376

U <sub>N</sub> (DC V)	Voltage range (DC V)	Resistance at 20°C Ω (±10%)	OW 5699.11/_ _ _	
			AgSnO <sub>2</sub> + 0.3 μm Au	AgNi 0,15 + 0.3 μm Au
4,5	3,3 ... 7,2	65	361	381
6	4,5 ... 9,6	155	362	382
12	9,0 ... 19,2	465	363	383
20	15,0 ... 32,0	1250	364	384
24	18,0 ... 38,4	1860	365	385
48	36,0 ... 76,8	6310	366	386

## Ordering Example

OW 5699 . \_ \_ / \_ \_ \_ / 61\*)

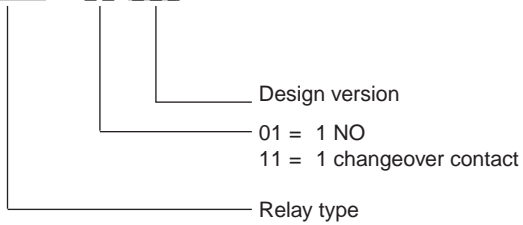

\*) /61 cURus approval

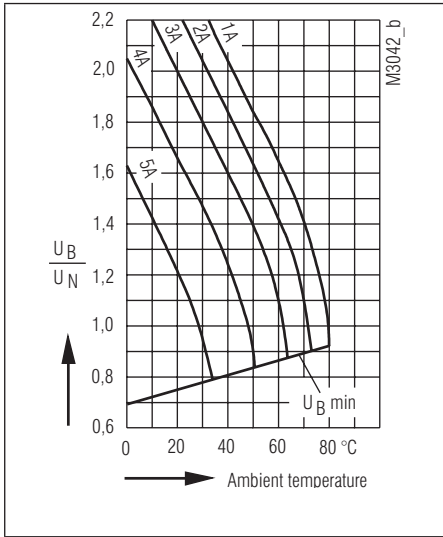

Operating voltage limit curve

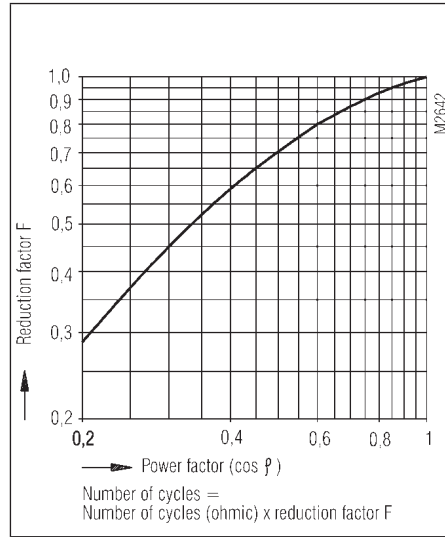

Reduction factor for inductive loads

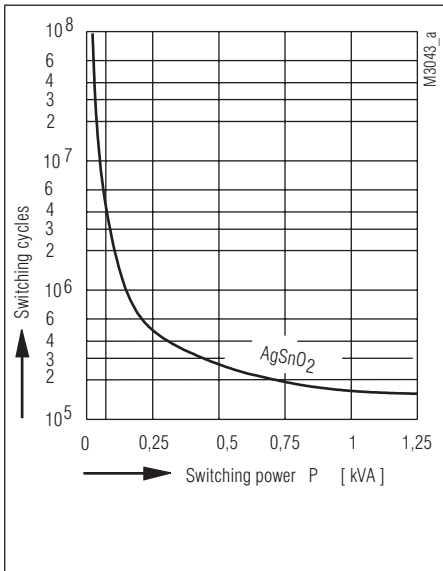

Contact service life

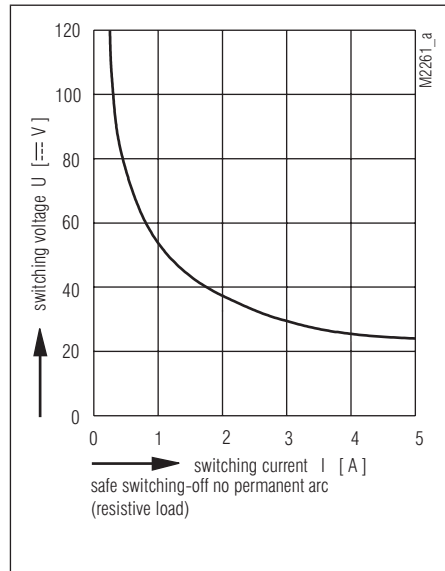

Limit curve for arc-free operation

Drilling plan (solder side)

OW 5699.11 SMD

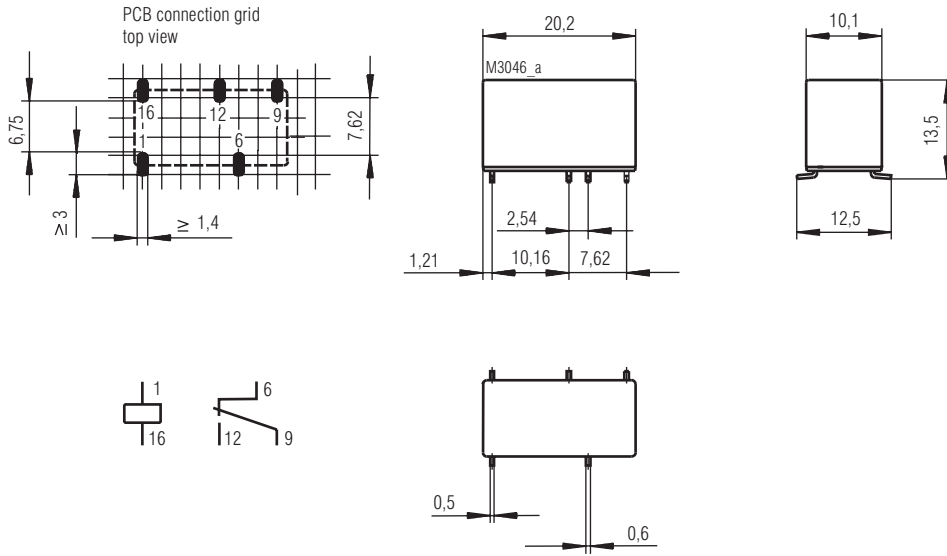

The tolerance of all pins being on the same level is +0,1

OW 5699.01 SMD

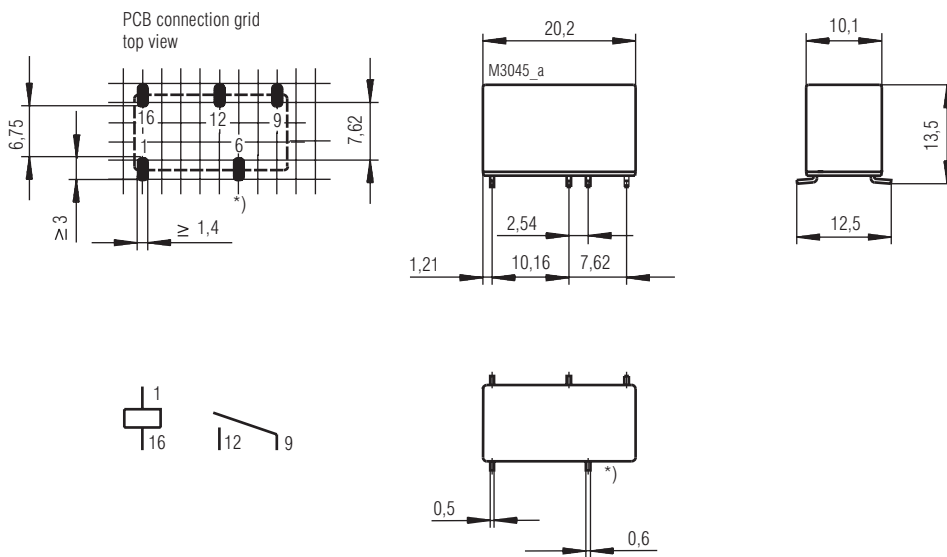

The tolerance of all pins being on the same level is +0,1  
 \*) Pin 6 and Pin 9 have same potential in initial state

Connection for basic grid dimensions 2.5 mm as well as 2.54 mm according to IEC/EN 60097 and IEC 60326 average

## DILAIS Power Miniature Relay, Remanence OR 5691



PCB-relay with 1 NO or 1 changeover contact.  
The contacts of the remanence relays stay in position after a current pulse until a pulse in reverse direction resets the contacts.

- According to DIN EN 61810-1, DIN EN 60664-1
- Clearance and creepage distances:  
contact - coil  $\geq 5.5$  mm
- High dielectric strength  $\geq 4$  kV
- High thermal continuous current  $I_{th} = 5$  A
- High switching power AC 250 V / 5 A
- Compact size  $V = 2.47$  cm<sup>3</sup>
- Very small volume **DIL model**, can be plugged into standard IC-socket
- Wash proof RT III

### Applications

- Control technique
- Interface

### Approvals and Markings



### Technical Data

Relay type		OR 5691
<b>1.0 Relay coil</b>		
1.1 Nominal voltage	DC V	4, 5, 6, 12, 20, 24, 48
1.2 Nominal consumption	W	0.7 (1u)
1.3 Test voltage coil/chassis	AC kV	$\geq 2.5$
1.4 Pulse length	ms	see diagram operate pulse length
1.5 Non operation voltage		$\leq 0.40 \times U_N$
1.6 Hold voltage		$\leq 0.025 \times U_N$ (opposite polarity of operating voltage)
1.7 Release voltage		see diagram reset time
1.8 Reset voltage		$\leq 0.18 \times U_N$ (opposite polarity of operating voltage)
1.9 max. permitted coil temperature	°C	120°C
1.10 Coil data		see page 4
1.11 Voltage range		0.80 ... 1.3 x $U_N$
1.12 Temperature resistance	k / W	
<b>2.0 Contacts</b>		
2.1 Contact arrangement		1 NO, 1 changeover contact
2.2 Contact material		AgSnO <sub>2</sub> + 0.3 $\mu$ m Au; AgNi + 0.3 $\mu$ m Au
2.3 Rated insulation voltage	AC V	250
Switching voltage min./max.	V	AC/DC 10 / DC 120, AC 250 V
2.4 Limiting continuous current $I_{th}$	A	5
Switching current min./max.	A	0.01 <sup>1)</sup> / 5
2.5 Switching power min./max.	VA	0.1 / 1 250
Switching power min./max.	W	0.1 / 120
2.6 Switching capacity to IEC/EN 60947-5-1		
AC 15	AC V/A	NC: 230 / 1 NO: 230 / 3
2.7 Electrical Life		at 1 s On, 1 s Off (see contacts service life)
at AC 230 V 1 A $\cos \varphi = 1$	switching cycles	$5 \times 10^5$
at AC 230 V 5 A $\cos \varphi = 1$	switching cycles	$1.5 \times 10^5$
2.8 Switching frequency max.	switching cycles /s	20
2.9 Response time / Release time	ms	typically $\leq 8$ / (see diagram reset time)
2.10 Contact force NO / NC	cN	8
2.12 Contact model		spring contact
2.13 Contact resistance	m $\Omega$	$\leq 30$ (measuring current 10 mA, measuring voltage 2 V DC)
2.14 Contact gap	mm	0.3 ... 0.4
2.15 Contact override	mm	$\geq 0.3$
2.16 Bouncing time		
(at $U_N$ ) NC	ms	$\leq 8$ (typisch 5.5) at $U_{AB} = 0.3 \times U_N$
(at $U_N$ ) NO	ms	$\leq 4.2$ (typisch 2,6) at $U_{AN} = U_N$
2.17 Impulse with stand voltage	kV	2; 1.2/50
2.18 Capacity		
between open contacts	pF	$\leq 2$ (typically 1.5)
between contact and coil	pF	$\leq 9$ (typically 7)

<sup>1)</sup> Typical values

## Technical Data

### 3.0 Other

3.1	Mechanical life	switching cycles	≥ 10 <sup>8</sup>
3.2	Temperature range	°C	- 40 ... + 65
3.3	Degree of protection		Wash proof RT III
3.5	Vibration resistance		10 ... 55 Hz; 1.2 mm amplitude; 10 g max. IEC/EN 60068-2-6
3.6	Climate resistance		20 / 065 / 04 (climate category); A/B/D IEC/EN 60068-1
3.8	Insulation according to IEC 60664-1		
	Rated insulation voltage	AC V	250
	Pollution degree		3
	Overvoltage category		III
	Test voltage		
	contact-coil (1 min)	AC kV eff.	≥ 4
	Clearance and creepage distances		
	Contact- Coil	mm	≥ 5.5 (safe separation acc. to EN 50178)
3.9	Weight	g	approx. 5
3.10	Dimensions	mm	see dimensions
3.13	Mounting direction		free
3.14	Operating mode		100 % duty cycle
3.15	Sealing		epoxy resin

### 4.0 Packing

4.1	on cardboard in slipcase	piece	100
4.2	in case package	piece	1000

### 5.0 Solder method

5.1	Solder method /-temperature /-duration	°C / s	Wafer soldering / 260 / 5
-----	--	--------	---------------------------

## Design Versions

U <sub>N</sub> DC	Resistance at 20°C Ω ± 10%	AgNi 0,15 + 0.3 μm Au	
		OR 5691.11/..	OR 5691.01/..
4.5	27	7521	7531
6	50	7522	7532
12	200	7523	7533
20	600	7524	7534
24	820	7525	7535
48	3300	7526	7536

## Ordering Example

OR 5691 . . . / . . . / 61\*)

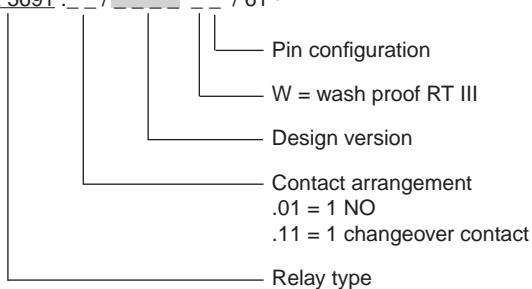

\*) /61 cURus approval

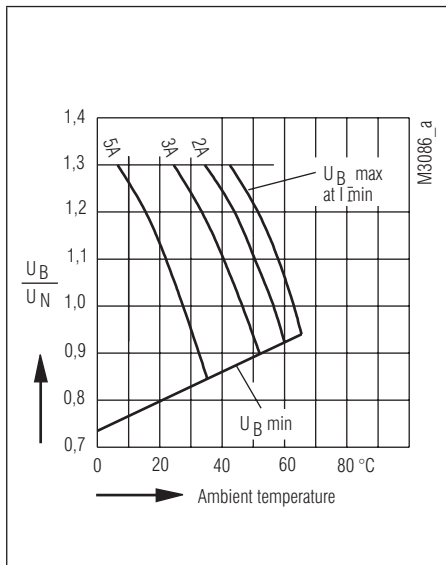

Operating voltage limit curve

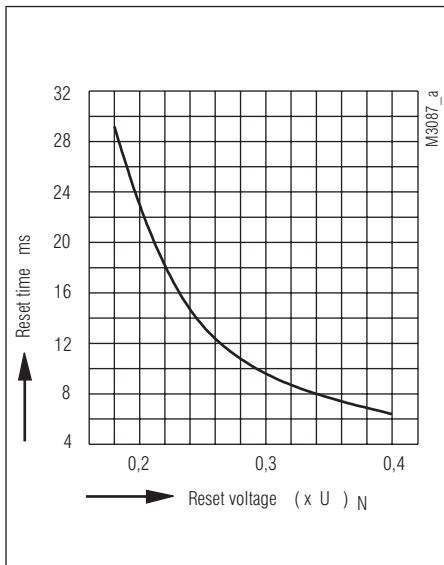

Reset time

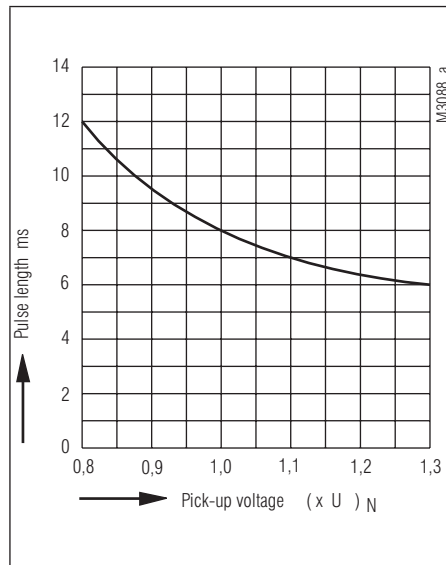

Response-impulse length

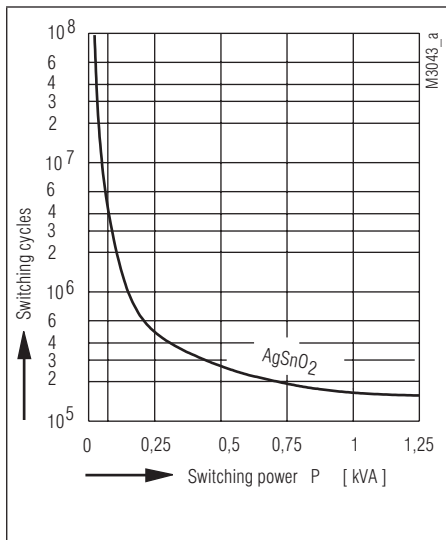

Contact service life

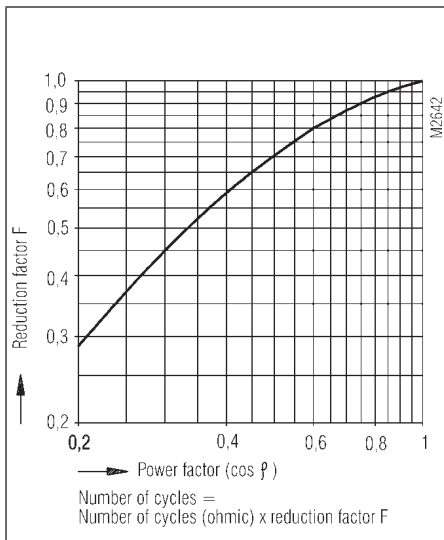

Reduction factor for inductive loads

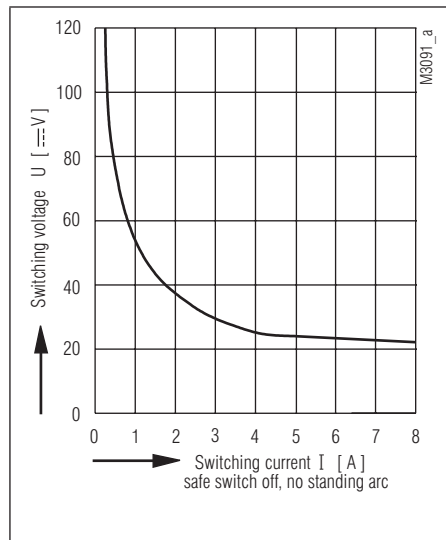

Limit curve for arc-free operation



## Dimensions, Pin Configuration, Connection Diagrams

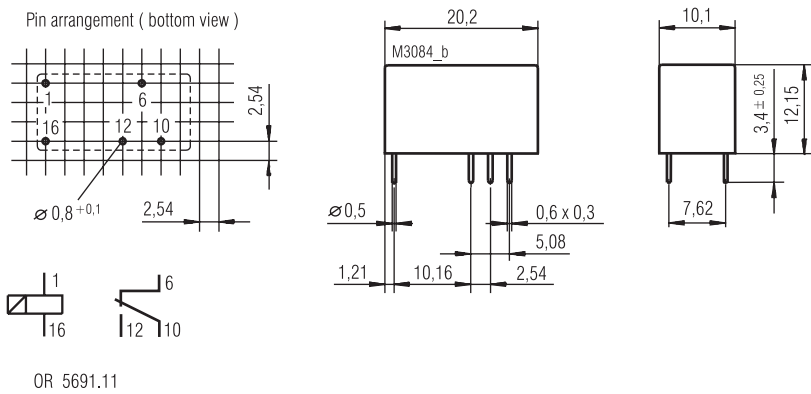
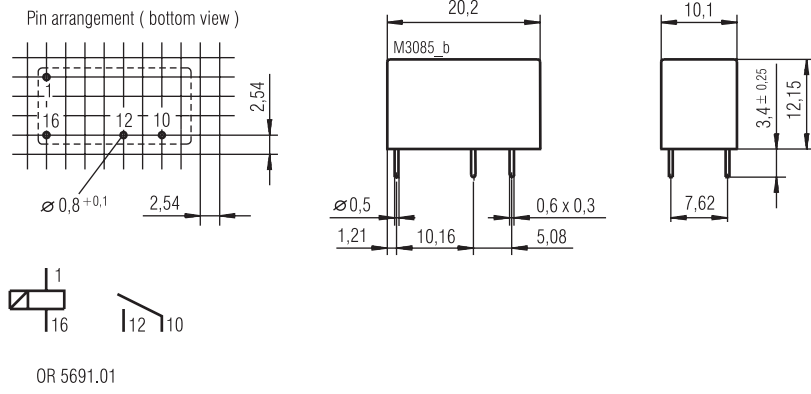

Connections for basic grid divisions 2.5 mm as well as 2.54 mm according to IEC/EN 60 097 and IEC 60 326 average.  
Pin distance tolerance measured at the pin ends  $\pm 0,3$  mm. Dimensions are valid for untinned state.

# GENERAL CONDITIONS FOR THE SUPPLY OF PRODUCTS AND SERVICES OF THE ELECTRICAL AND ELECTRONICS INDUSTRY ("GL")\*

for commercial transactions between businesses



recommended by ZVEI - Zentralverband Elektrotechnik- und Elektronikindustrie e. V.

– as of June 2005 –

## I. GENERAL PROVISIONS

1. Legal relations between Supplier and Purchaser in connection with supplies and/or services of the Supplier (hereinafter referred to as "Supplies") shall be solely governed by the present GL. The Purchaser's general terms and conditions shall apply only if expressly accepted by the Supplier in writing. The scope of delivery shall be determined by the congruent mutual written declarations.
  2. The Supplier herewith reserves any industrial property rights and/or copyrights pertaining to its cost estimates, drawings and other documents (hereinafter referred to as "Documents"). The Documents shall not be made accessible to third parties without the Supplier's prior consent and shall, upon request, be returned without undue delay to the Supplier if the contract is not awarded to the Supplier. Sentences 1 and 2 shall apply mutatis mutandis to the Purchaser's Documents; these may, however, be made accessible to those third parties to whom the Supplier has rightfully subcontracted Supplies.
  3. The Purchaser has the non-exclusive right to use standard software and firmware, provided that it remains unchanged, is used within the agreed performance parameters, and on the agreed equipment. Without express agreement the Purchaser may make one back-up copy of standard software.
  4. Partial deliveries are allowed, unless they are unreasonable to accept for the Purchaser.
  5. The term „claim for damages” used in the present GL also includes claims for indemnification for useless expenditure.
2. If non-observance of the times set is due to force majeure such as mobilization, war, rebellion or similar events, e. g. strike or lockout, such time shall be extended accordingly. The same shall apply if the Supplier does not receive its own supplies in due time or in due form.
  3. If the Supplier is responsible for the delay (hereinafter referred to as "Delay") and the Purchaser has demonstrably suffered a loss therefrom, the Purchaser may claim a compensation as liquidated damages of 0.5 % for every completed week of Delay, but in no case more than a total of 5 % of the price of that part of the Supplies which due to the Delay could not be put to the intended use.
  4. Purchaser's claims for damages due to delayed Supplies as well as claims for damages in lieu of performance exceeding the limits specified in No. 3 above are excluded in all cases of delayed Supplies, even upon expiry of a time set to the Supplier to effect the Supplies. This shall not apply in cases of mandatory liability based on intent, gross negligence, or due to loss of life, bodily injury or damage to health. Rescission of the contract by the Purchaser based on statute is limited to cases where the Supplier is responsible for the delay. The above provisions do not imply a change in the burden of proof to the detriment of the Purchaser.
  5. At the Supplier's request, the Purchaser shall declare within a reasonable period of time whether it, due to the delayed Supplies, rescinds the contract or insists on the delivery of the Supplies.
  6. If dispatch or delivery, due to Purchaser's request, is delayed by more than one month after notification of the readiness for dispatch was given, the Purchaser may be charged, for every additional month commenced, storage costs of 0.5 % of the price of the items of the Supplies, but in no case more than a total of 5 %. The parties to the contract may prove that higher or, as the case may be, lower storage costs have been incurred.

## II. PRICES, TERMS OF PAYMENT, AND SET-OFF

1. Prices are ex works and excluding packaging; value added tax shall be added at the then applicable rate.
2. If the Supplier is also responsible for assembly or erection and unless otherwise agreed, the Purchaser shall pay the agreed remuneration and any incidental costs required, e. g. for traveling and transport as well as allowances.
3. Payments shall be made free Supplier's paying office.
4. The Purchaser may set off only those claims which are undisputed or non-appealable.

## III. RETENTION OF TITLE

1. The items pertaining to the Supplies ("Retained Goods") shall remain the Supplier's property until each and every claim the Supplier has against the Purchaser on account of the business relationship has been fulfilled. If the combined value of the Supplier's security interests exceeds the value of all secured claims by more than 10 %, the Supplier shall release a corresponding part of the security interest if so requested by the Purchaser; the Supplier shall be entitled to choose which security interest it wishes to release.
2. For the duration of the retention of title, the Purchaser may not pledge the Retained Goods or use them as security, and resale shall be possible only for resellers in the ordinary course of their business and only on condition that the reseller receives payment from its customer or makes the transfer of property to the customer dependent upon the customer fulfilling its obligation to effect payment.
3. The Purchaser shall inform the Supplier forthwith of any seizure or other act of intervention by third parties.
4. Where the Purchaser fails to fulfil its duties, fails to make payment due, or otherwise violates its obligations the Supplier shall be entitled to rescind the contract and take back the Retained Goods in the case of continued failure following expiry of a reasonable remedy period set by the Supplier; the statutory provisions providing that a remedy period is not needed shall be unaffected. The Purchaser shall be obliged to return the Retained Goods. The fact that the Supplier takes back Retained Goods and/or exercises the retention of title, or has the Retained Goods seized, shall not be construed to constitute a rescission of the contract, unless the Supplier so expressly declares.

## IV. TIME FOR SUPPLIES; DELAY

1. Times set for Supplies shall only be binding if all Documents to be furnished by the Purchaser, necessary permits and approvals, especially concerning plans, are received in time and if agreed terms of payment and other obligations of the Purchaser are fulfilled. If these conditions are not fulfilled in time, times set shall be extended reasonably; this shall not apply if the Supplier is responsible for the delay.

## V. PASSING OF RISK

1. Even where delivery has been agreed freight free, the risk shall pass to the Purchaser as follows:
  - a) if the Supplies do not include assembly or erection, at the time when the Supplies are shipped or picked up by the carrier. Upon the Purchaser's request, the Supplier shall insure the Supplies against the usual risks of transport at the Purchaser's expense;
  - b) if the Supplies include assembly or erection, at the day of taking over in the Purchaser's own works or, if so agreed, after a fault-free trial run.
2. The risk shall pass to the Purchaser if dispatch, delivery, the start or performance of assembly or erection, the taking over in the Purchaser's own works, or the trial run is delayed for reasons for which the Purchaser is responsible or if the Purchaser has otherwise failed to accept the Supplies.

## VI. ASSEMBLY AND ERECTION

Unless otherwise agreed in writing form, assembly and erection shall be subject to the following provisions:

1. The Purchaser shall provide at its own expense and in due time:
  - a) all earth and construction work and other ancillary work outside the Supplier's scope, including the necessary skilled and unskilled labor, construction materials and tools,
  - b) the equipment and materials necessary for assembly and commissioning such as scaffolds, lifting equipment and other devices as well as fuels and lubricants,
  - c) energy and water at the point of use including connections, heating and lighting,
  - d) suitable dry and lockable rooms of sufficient size adjacent to the site for the storage of machine parts, apparatus, materials, tools, etc. and adequate working and recreation rooms for the erection personnel, including sanitary facilities as are appropriate in the specific circumstances; furthermore, the Purchaser shall take all measures it would take for the protection of its own possessions to protect the possessions of the Supplier and of the erection personnel at the site,
  - e) protective clothing and protective devices needed due to particular conditions prevailing on the specific site.
2. Before the erection work starts, the Purchaser shall unsolicitedly make available any information required concerning the location of concealed electric power, gas and water lines or of similar installations as well as the necessary structural data.
3. Prior to assembly or erection, the materials and equipment necessary for the work to start must be available on the site of assembly or erection and any preparatory work must have advanced to such a degree that assembly or erection can be started as agreed and carried out without interruption. Access roads and the site of assembly or erection must be level and clear.

\* "Grüne Lieferbedingungen". The original German text shall be the governing version.

4. If assembly, erection or commissioning is delayed due to circumstances for which the Supplier is not responsible, the Purchaser shall bear the reasonable costs incurred for idle times and any additional traveling expenditure of the Supplier or the erection personnel.
5. The Purchaser shall attest to the hours worked by the erection personnel towards the Supplier at weekly intervals and the Purchaser shall immediately confirm in written form if assembly, erection or commissioning has been completed.
6. If, after completion, the Supplier demands acceptance of the Supplies, the Purchaser shall comply therewith within a period of two weeks. In default thereof, acceptance is deemed to have taken place. Acceptance is also deemed to have been effected if the Supplies are put to use, after completion of an agreed test phase, if any.

#### VI. RECEIVING SUPPLIES

The Purchaser shall not refuse to receive Supplies due to minor defects.

#### VIII. DEFECTS AS TO QUALITY

The Supplier shall be liable for defects as to quality ("Sachmängel", hereinafter referred to as "Defects"), as follows:

1. Defective parts or defective services shall be, at the Supplier's discretion, repaired, replaced or provided again free of charge, provided that the reason for the Defect had already existed at the time when the risk passed.
2. Claims for repair or replacement are subject to a statute of limitations of 12 months calculated from the start of the statutory statute of limitations; the same shall apply mutatis mutandis in the case of rescission and reduction. This shall not apply where longer periods are prescribed by law according to Sec. 438 para. 1 No. 2 (buildings and things used for a building), Sec. 479 para. 1 (right of recourse), and Sec. 634a para. 1 No. 2 (defects of a building) German Civil Code ("BGB"), in the case of intent, fraudulent concealment of the Defect or non-compliance with guaranteed characteristics (Beschaffheitsgarantie). The legal provisions regarding suspension of the statute of limitations ("Ablaufhemmung", "Hemmung") and recommencement of limitation periods shall be unaffected.
3. Notifications of Defect by the Purchaser shall be given in written form without undue delay.
4. In the case of notification of a Defect, the Purchaser may withhold payments to an amount that is in a reasonable proportion to the Defect. The Purchaser, however, may withhold payments only if the subject-matter of the notification of the Defect involved is justified and incontestable. The Purchaser has no right to withhold payments to the extent that its claim of a Defect is time-barred. Unjustified notifications of Defect shall entitle the Supplier to demand reimbursement of its expenses by the Purchaser.
5. The Supplier shall be given the opportunity to repair or to replace the defective good ("Nacherfüllung") within a reasonable period of time.
6. If repair or replacement is unsuccessful, the Purchaser is entitled to rescind the contract or reduce the remuneration; any claims for damages the Purchaser may have according to No. 10 shall be unaffected.
7. There shall be no claims based on Defect in cases of insignificant deviations from the agreed quality, of only minor impairment of usability, of natural wear and tear, or damage arising after the passing of risk from faulty or negligent handling, excessive strain, unsuitable equipment, defective civil works, inappropriate foundation soil, or claims based on particular external influences not assumed under the contract, or from non-reproducible software errors. Claims based on defects attributable to improper modifications or repair work carried out by the Purchaser or third parties and the consequences thereof are likewise excluded.
8. The Purchaser shall have no claim with respect to expenses incurred in the course of supplementary performance, including costs of travel, transport, labor, and material, to the extent that expenses are increased because the subject-matter of the Supplies has subsequently been brought to another location than the Purchaser's branch office, unless doing so complies with the normal use of the Supplies.
9. The Purchaser's right of recourse against the Supplier pursuant to Sec. 478 BGB is limited to cases where the Purchaser has not concluded an agreement with its customers exceeding the scope of the statutory provisions governing claims based on Defects. Moreover, No. 8 above shall apply mutatis mutandis to the scope of the right of recourse the Purchaser has against the Supplier pursuant to Sec. 478 para. 2 BGB.
10. The Purchaser shall have no claim for damages based on Defects. This shall not apply to the extent that a Defect has been fraudulently concealed, the guaranteed characteristics are not complied with, in the case of loss of life, bodily injury or damage to health, restrictions to liberty and/or intentionally or grossly negligent breach of contract on the part of the Supplier. The above provisions do not imply a change in the burden of proof to the detriment of the Purchaser. Any other or additional claims of the Purchaser exceeding the claims provided for in this Article VIII, based on a Defect, are excluded.

#### IX. INDUSTRIAL PROPERTY RIGHTS AND COPYRIGHT; DEFECTS IN TITLE

1. Unless otherwise agreed, the Supplier shall provide the Supplies free from third parties' industrial property rights and copyrights (hereinafter referred to as "IPR") with respect to the country of the place of delivery only. If a third party asserts a justified claim against the Purchaser based on an infringement of an IPR by the Supplies made by the Supplier and used in conformity with the contract, the Supplier shall be liable to the Purchaser within the time period stipulated in Article VIII No. 2 as follows:

- a) The Supplier shall choose whether to acquire, at its own expense, the right to use the IPR with respect to the Supplies concerned or whether to modify the Supplies such that they no longer infringe the IPR or replace them. If this would be impossible for the Supplier under reasonable conditions, the Purchaser may rescind the contract or reduce the remuneration pursuant to the applicable statutory provisions.
- b) The Supplier's liability to pay damages is governed by Article XI.
- c) The above obligations of the Supplier shall apply only if the Purchaser (i) immediately notifies the Supplier of any such claim asserted by the third party in written form, (ii) does not concede the existence of an infringement and (iii) leaves any protective measures and settlement negotiations to the Supplier's discretion. If the Purchaser stops using the Supplies in order to reduce the damage or for other good reason, it shall be obliged to point out to the third party that no acknowledgement of the alleged infringement may be inferred from the fact that the use has been discontinued.

2. Claims of the Purchaser shall be excluded if it is responsible for the infringement of an IPR.
3. Claims of the Purchaser are also excluded if the infringement of the IPR is caused by specifications made by the Purchaser, by a type of use not foreseeable by the Supplier or by the Supplies being modified by the Purchaser or being used together with products not provided by the Supplier.
4. In addition, with respect to claims by the Purchaser pursuant to No. 1 a) above, Article VIII Nos. 4, 5, and 9 shall apply mutatis mutandis in the event of an infringement of an IPR.
5. Where other defects in title occur, Article VIII shall apply mutatis mutandis.
6. Any other claims of the Purchaser against the Supplier or its agents or any such claims exceeding the claims provided for in this Article IX, based on a defect in title, are excluded.

#### X. IMPOSSIBILITY OF PERFORMANCE; ADAPTATION OF CONTRACT

1. To the extent that delivery is impossible, the Purchaser is entitled to claim damages, unless the Supplier is not responsible for the impossibility. The Purchaser's claim for damages is, however, limited to an amount of 10 % of the value of the part of the Supplies which, owing to the impossibility, cannot be put to the intended use. This limitation shall not apply in the case of mandatory liability based on intent, gross negligence or loss of life, bodily injury or damage to health; this does not imply a change in the burden of proof to the detriment of the Purchaser. The Purchaser's right to rescind the contract shall be unaffected.
2. Where unforeseeable events within the meaning of Article IV No. 2 substantially change the economic importance or the contents of the Supplies or considerably affect the Supplier's business, the contract shall be adapted taking into account the principles of reasonableness and good faith. To the extent this is not justifiable for economic reasons, the Supplier shall have the right to rescind the contract. If the Supplier intends to exercise its right to rescind the contract, it shall notify the Purchaser thereof without undue delay after having realized the repercussions of the event; this shall also apply even where an extension of the delivery period has previously been agreed with the Purchaser.

#### XI. OTHER CLAIMS FOR DAMAGES; STATUTE OF LIMITATIONS

1. The Purchaser has no claim for damages based on whatever legal reason, including infringement of duties arising in connection with the contract or tort.
2. The above shall not apply in the case of mandatory liability, e. g. under the German Product Liability Act ("Produkthaftungsgesetz"), in the case of intent, gross negligence, loss of life, bodily injury or damage to health, or breach of a condition which goes to the root of the contract ("wesentliche Vertragspflichten"). However, claims for damages arising from a breach of a condition which goes to the root of the contract shall be limited to the foreseeable damage which is intrinsic to the contract, unless caused by intent or gross negligence or based on liability for loss of life, bodily injury or damage to health. The above provision does not imply a change in the burden of proof to the detriment of the Purchaser.
3. To the extent that the Purchaser has a claim for damages, it shall be time-barred upon expiration of the statute of limitations pursuant to Article VIII No. 2. The same shall apply to the Purchaser's claims in connection with actions undertaken to avoid any damage (e. g. callback). In the case of claims for damages under the German Product Liability Act, the statutory statute of limitations shall apply.

#### XII. VENUE AND APPLICABLE LAW

1. If the Purchaser is a businessman, sole venue for all disputes arising directly or indirectly out of the contract shall be the Supplier's place of business. However, the Supplier may also bring an action at the Purchaser's place of business.
2. Legal relations existing in connection with this contract shall be governed by German substantive law, to the exclusion of the United Nations Convention on contracts for the International Sale of Goods (CISG).

#### XIII. SEVERABILITY CLAUSE

The legal invalidity of one or more provisions of this Agreement in no way affects the validity of the remaining provisions. This shall not apply if it would be unreasonable for one of the parties to be obligated to continue the contract.



**DOLD** 

**E. DOLD & SÖHNE KG**  
P.O. Box 1251 • 78114 Furtwangen • Germany  
Phone +49 7723 6540 • Fax +49 7723 654356  
dold-relays@dold.com • www.dold.com