

Switch cabinet housings



Distribution housings



Appropriate housings
for each application

DOLD 
Our experience. Your safety.

Overview of the housing ranges

Mounting rail bus system

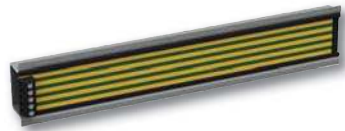

In-Rail Bus.....6

- ▶ Continuous mounting rail bus
- ▶ Versatile for all top-hat rail housings
- ▶ Reliable transmission of signals, data and energy
- ▶ Perfectly fitting mounting rail sections for smooth installation
- ▶ For all standard TS 35 mounting rails with a height of 7.5 mm or 15 mm
- ▶ Supersedes costly wiring of individual conductors in modular applications
- ▶ Quick and easy module replacement in systems
- ▶ Also suitable for device-internal bus connections between multiple functional modules
- ▶ UL-approved

Switch cabinet housings



K 70.....14

- ▶ Widths from 22.5 mm to 150 mm
- ▶ With up to 32 flat-type terminals
- ▶ With captive plus-minus screws
- ▶ Options: with terminal covers
- ▶ Versatile PCB mounting
- ▶ For DIN rail and screw mounting
- ▶ Option: for use with In-Rail-Bus

Switch cabinet housings



KS 4400.....8

- ▶ Widths from 12.5 mm to 90 mm
- ▶ Modular, flexible, innovative
- ▶ Large and stable front and large PCB area
- ▶ Plenty of space
- ▶ Variable connection system
- ▶ For automated and cost-efficient manufacturing
- ▶ Option: with In-Rail bus for quick and reliable data and energy transmission
- ▶ Can be specifically tailored to customer requirements
- ▶ UL-conform

KO 4070.....15

- ▶ Widths from 12.5 mm to 28 mm
- ▶ Heights from 60 mm to 90 mm
- ▶ With up to 16 flat-type terminals
- ▶ With captive plus-minus screws
- ▶ PCB mounting in 3 tiers
- ▶ With double machine solderable pins
- ▶ Option: exchangeable front plate



KO 4300.....10

- ▶ Widths from 22.5 mm to 90 mm
- ▶ Housing depths 188 mm or 97 mm
- ▶ Terminal blocks can be machine soldered on PCBs
- ▶ Options:
 - Plug-in screw-type or spring-loaded terminals
 - Housings without terminals
 - Ventilation slots
 - Earthing contact to the top-hat rail
 - Hinged front panel
 - In-Rail bus
- ▶ UL-approved



KO 4900.....16

- ▶ Widths from 17.5 mm to 70 mm with up to 32 terminals
- ▶ With captive plus-minus screws or cage clamps
- ▶ Reliable clamping of max. 2 wire with differing cross sections
- ▶ Terminal blocks can be machine soldered on PCBs
- ▶ For DIN rail and screw mounting
- ▶ Option: with plug-type bus connectors, e.g. KNX, RJ45
- ▶ Option: with In-Rail bus
- ▶ UL-conform



KO 4030.....12

- ▶ Widths from 22.5 mm to 90 mm
- ▶ With up to 56 box terminals with captive plus-minus screws
- ▶ Detachable terminal blocks for plug-in connection on the PCB
- ▶ Terminal blocks options: 3, 4 or 7 terminals or as blind block without terminals
- ▶ With exchangeable front panel
- ▶ Options: with heavy-duty terminals and heat sink
- ▶ Options: with In-Rail bus
- ▶ UL-approved

Distribution housings

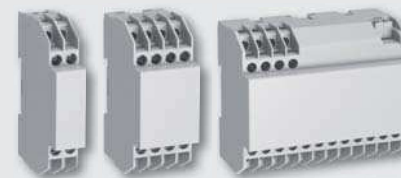

KU 4000.....16

- ▶ Widths from 8.8 mm to 140 mm with up to 64 terminals
- ▶ With captive plus-minus screws or cage clamps
- ▶ Reliable clamping of 2 wires as a maximum, also with different cross sections
- ▶ Terminal blocks can be machine soldered on PCBs with additional terminals for stranded conductors
- ▶ Option: with 50 A heavy-duty terminals
- ▶ Option: with exchangeable front plate
 - with plug-type bus connectors, e.g. KNX, RJ45
 - with In-Rail bus
- ▶ UL-conform



KO 4000.....13

- ▶ Widths from 22.5 mm to 200 mm
- ▶ Terminal strips can be mounted on PCBs by soldering or plug-type connection
- ▶ Box or flat-type terminals
- ▶ Optionally with blanking strips without terminals
- ▶ With exchangeable front panel
- ▶ Versatile PCB mounting
- ▶ Captive plus-minus screws
- ▶ Optionally with In-Rail bus



KU 4100.....18

- ▶ Widths from 17.5 mm to 140 mm
- ▶ Nominal depth 64 mm for depth gauge
- ▶ Max. 70 mm mounted height as per DIN 43880
- ▶ With selectable connection system
- ▶ Suited for the accommodation of up to two PCBs with terminals and an additional PCB for display and control elements in the housing front
- ▶ Option: with plug-type bus connectors, e.g. KNX, RJ45
 - with exchangeable front
 - with In-Rail bus
- ▶ UL-conform

Standard and customized enclosures

Electronics enclosures



We have the know how:

DOLD has engineered and produced plastic and metal housings in Furtwangen for decades. Our team knows how to create the refined features that define a smartly designed and practical industrial housing. Our state-of-the-art production lines reduce manufacturing costs by the production of large unit quantities.

Functional and variable.

DOLD offers a wide range of different enclosures for installation in control cabinets, consumer units and industrial distribution boards. Therefore finding an enclosure solution to meet the demands of various applications is always possible.

Modular and customer-specific.

Do you prefer to use an electronics enclosure which has been designed exclusively for your special applications? DOLD develops and manufactures customer-specific tailor made electronics enclosures and can also provide you with the matching terminals.



Measuring and control

Facility automation

Automation

Communication

Laboratory/medical systems

Renewable energy

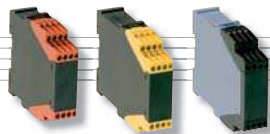

DOLD produce enclosures to cover a wide variety of applications.

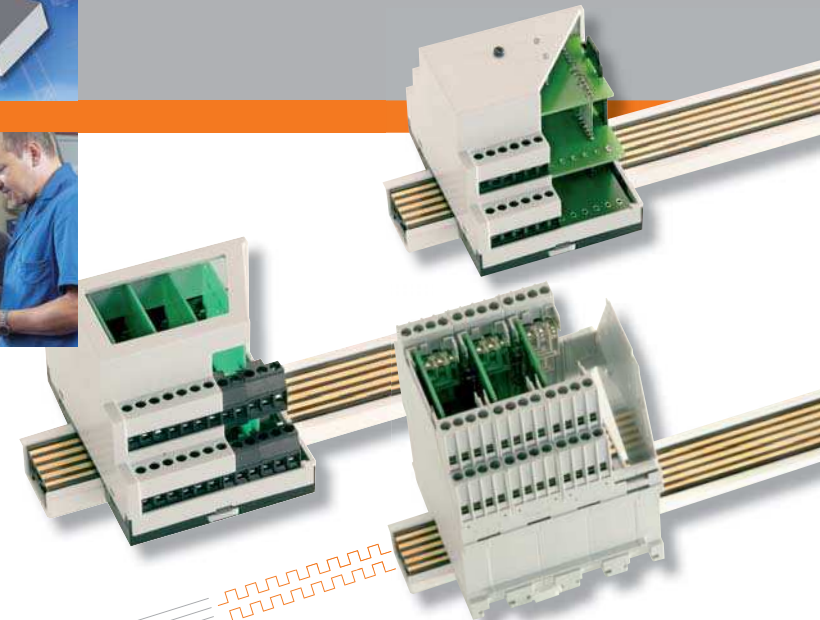

DOLD has engineered and produced plastic and metal enclosures in series production for decades.



IN-RAIL BUS

Flexible. Easy. Secure.

This user-friendly and highly flexible BUS system is the smartest solution for a reliable and quick transmission of signals, data and energy. In modular applications, it replaces costly wiring when it comes to connection, distribution or even power supply. Thus, this In-Rail bus reduces wiring costs and error-proneness. It offers higher efficiency, great flexibility and also makes later system changes a breeze.

The IN-RAIL BUS system is based on a carrier section. It can be easily integrated in the 35 mm standard DIN rail and accommodates the BUS pcb that can be individually configured. With its high flexibility, this concept allows a variety of custom solutions.



User-friendly and easy to service

Quick and easy module installation, even in existing module configurations without effect on adjacent modules. This saves time and costs also in case of module change.



Free choice of positions

Free positioning of the modules on all 35 mm standard carrier rails. An optional coding allows you to specify positions. Covers are available for unused sections.

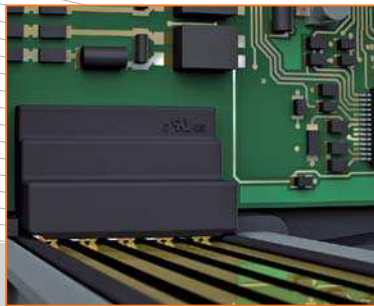

Connecting rather than wiring

Module connection is made by simple snapping onto the top-hat rail rather than costly wiring. When doing so, the module is safely connected to the In-Rail bus.



Highly scalable

Consistent connecting solution for all housing types and widths from the 17.5 mm narrow compact solution up to large housings with almost any width.

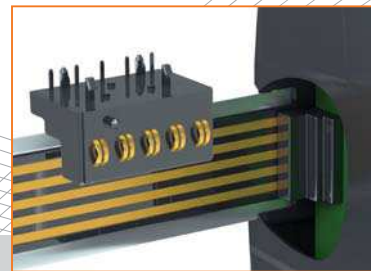

High contact reliability

The machine-solderable contact spring block with its gold-plated contacts ensures a permanent contact to the In-Rail bus. This prevents unwanted bus interruptions and high contact resistances and thus provides a maximal availability of your system.



Cost-effective manufacturing

In a single process step, each BUS contact block is soldered in the device's pcb together with the electronic components of the device. There is no need for manual rework.

Advantages of the IN-RAIL BUS:

- ▶ Reliable and quick transmission of signals, data and energy
- ▶ Replaces costly individual wiring
- ▶ Quick and cost-effective module exchange
- ▶ Protection against accidental contact by configurable rail covers and end caps
- ▶ Allows a variety of custom solutions
- ▶ Also suitable for device-internal BUS connections between multiple functional modules
- ▶ UL-approved

What can we do for you?



Economical and adaptable

The In-Rail Bus replaces the costly individual wiring by an uninterrupted and flexible system solution. It is safely integrated in a standard 35 mm top-hat rail. Perfectly fitting carrier sections allow the use of standard rails with a height of 7.5 mm or 15 mm.



KS 4400

Simple. Modular. Flexible.

Modern electronics demands innovative enclosure solutions. From design, through production to final supply, the KS 4400 Series is an ideal platform for numerous applications from stand-alone devices to full system integration offering more decentralised distribution functions.

This universal enclosure system, in modular widths from 12.5mm to 90mm and optional In-Rail-Bus assembly, provides the user with extensive design and assembly space. Its distinctive, aesthetically appealing design and high functionality, enable the realisation of your individual ideas.

So, what can we do for you?



A choice of variable Terminal solutions

The modular concept allows the usage of different terminal types. The number of terminals can be arranged according to requirements. Up to 30 terminals are available in each 22.5 mm module width.



More space for your ideas

The large and stable front face provides an individual area with considerable space for operator, communications and visual display components, such as programmable interfaces, together with extensive space for laser etching or printing.

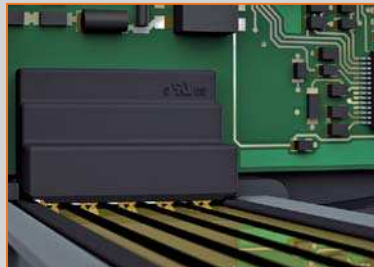

Connecting instead of wiring

The BUS-rail provides quick and reliable data and energy transfer, and BUS-rail "crossovers" and "breaks" may be avoided.

Gold plated double contacts of the terminal blocks provide a permanent contact to the BUS-rail for maximum safety and security.

Enclosures are simply "slipped" on to the DIN-rail and can be freely positioned.

Module changes can be quickly and easily made within the existing system.



More space for More design

The large, usable PCB area, provides exceptional space utilisation for the realisation of your ideas.



Reduced Assembly Time & Effort

The casing design allows for highly cost-effective, automated assembly.

Features KS 4400:

- ▶ Simple, cost effective, assembly
- ▶ Intelligent construction
- ▶ Available in all current module widths
- ▶ More space for electronic components
- ▶ Customer-specific models

So, what can we do for you?



Connecting instead of wiring:
The option "In-Rail-Bus" replaces the tedious individual wiring process with an uninterrupted and flexible system solution. The system bus is securely integrated within the 35mm DIN-rail. Whether 7.5mm or 15mm high – the custom-fit profiles provide easy installation.

KO 4300

Space-saving. With selectable connection system.

With their electronic housings of the compact range KO 4300, DOLD supports the trend towards miniaturisation - without any compromises in the connection convenience. Apart from conventional screw-type terminals, the housings can also be equipped with advanced spring-loaded terminals, for example. They considerably reduce the time required for the device connection. In addition to this, both designs are available with plug-type terminal blocks which provide additional advantages and savings potential. With such detachable terminal blocks the user not only benefits from an easier installation, but also from a faster device replacement with fixed wiring in the case of service. Also a pre-assembly without device is possible.



Selectable connection system

Fixed integrated or pluggable. Plug-type terminal blocks with screw-type or spring-loaded terminals allow for a quick replacement of devices.



Efficient device manufacturing

A sophisticated housing design allows for an installation without any tools and an easy and cost-efficient device manufacturing. Once the device has passed the final test, the PCB module together with the terminals and the front plate can be easily installed in the housing hood.

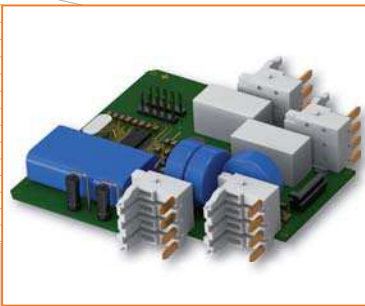

Solderable by machines

The terminal blocks can be plugged or cost-efficiently soldered together with control elements and components on PCBs in a single pass. All common mechanical solder technologies are suitable for this.



Modularity

Standard widths from 22.5 mm to 90 mm and optional housing depths from 97 mm or 118 mm allow an optimal size customisation.



Many terminals

There are up to 16 terminals per modular width of 22.5 mm on a maximum of two terminal levels available.



Variable front design

Variable front design, also without terminals. This provides more space for the module and on the housing front for alternative connection systems.

Many options:

- ▶ **Individual housing openings**
For an optimal customisation to specific requirements, it is possible to manufacture housings with individual openings, e.g. ventilation slots for better heat dissipation or for bus connectors.
- ▶ **Exchangeable/hinged front**
Protects adjusting and indicating elements and is available with or without an intermediate bottom and in transparent, light-grey or other colours.
- ▶ **Earthing spring**
An optionally integrated earthing spring below the housing bottom provides improved EMC properties. When the housing is snapped on the DIN rail the PCB is automatically connected to the DIN rail.

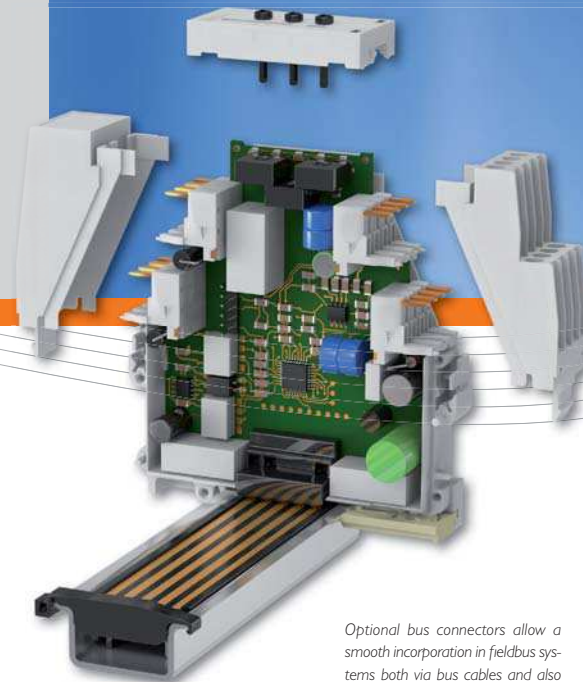

Optional bus connectors allow a smooth incorporation in fieldbus systems both via bus cables and also via mounting rail bus (In-Rail bus).

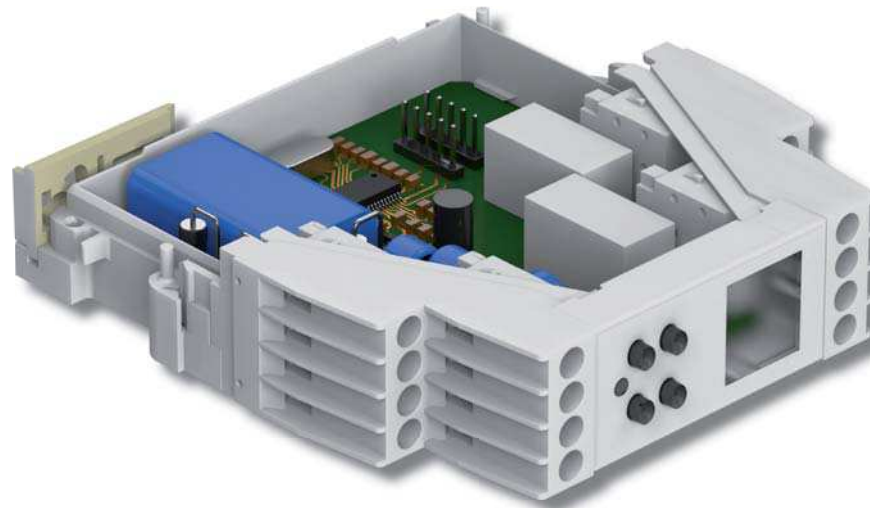

KO 4030

with variable terminal quantity

The electronic housings of this variable system excel by their detachable terminal blocks. They are available in different designs while maintaining the same overall dimensions. You can choose from terminal blocks with plug-type box terminals in a variable quantity or with solderable heavy-duty terminals, for example. Because any combination of the different terminal blocks is possible, the housings can be easily tailored to specific applications.



Connection system

Plug-type terminal blocks with box terminals or solderable heavy-duty terminal blocks with 3 box terminals. The plug-type terminal blocks of the same housing can be combined in any way, even partly with heavy-duty terminals.

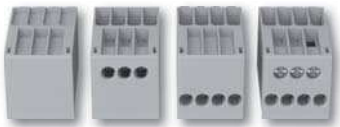

Variable terminal quantity

The plug-type terminal blocks can be equipped with 3, 4 or 7 box terminals. A blind block without terminals is also available.



Exchangeable front panel

An exchangeable front panel allows you to cover adjusting and indicating elements. It is available in various colours or transparent.



Modularity

Widths from 22.5 mm to 90 mm allow an optimal adjustment to different sizes.



Heavy-duty design

As an option, the housing can be equipped with heavy-duty terminals up to 40 A.

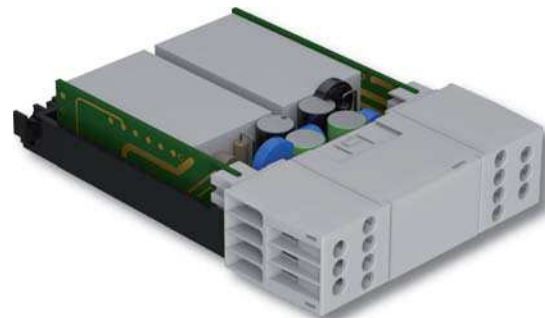

KO 4000

Versatile housing system with various sizes

Electronic housings of this very diverse range are available in a variety of sizes. From the 22.5 mm wide compact housing with 8 terminals up to the 200 mm wide large housing with up to 132 terminals. For devices that require more space, the 200 mm wide version can also be delivered with a height of 123 mm apart from the standard height of 73 mm.



Connection system

Available with box or flat-type terminals, mechanically solderable terminal strips or plug-type terminal strips for quick device replacement. Blind strips without terminals are also available.



Exchangeable front panel

An exchangeable front panel allows you to cover adjusting and indicating elements. It is available in various colours or transparent.



PCB integration

Guiding ribs allow for an easy accommodation of up to 5 horizontal PCBs. An additional PCB parallel to the housing front is especially suitable for the accommodation of adjusting and indicating elements.



Modularity

Widths from 22.5 mm to 200 mm allow a fine stepped adjustment in size.

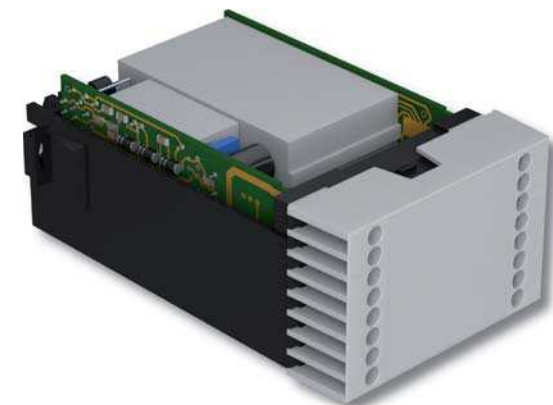

K 70

Housing system with many widths proved in various applications

This consistent housing range allows for an especially fine graded adjustment to the size of the electronics. Thus, this housing system not only covers the common widths from 22.5 mm to 150 mm, but also provides intermediate sizes such as 32.5 mm or 55 mm. These housings are suitable for both DIN rail mounting and screw mounting.



Connection system

With up to 32 flat-type terminals with captive plus-minus screws and self-lifting terminal plates for solder connection. Additional direct plug-type installation available from widths ≥ 75 mm.

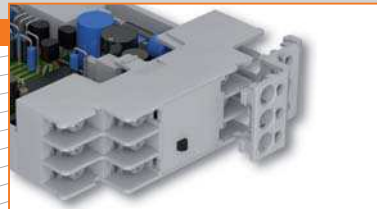

Protection against accidental contact

Optionally, terminal covers for protection against accidental contact as per VBG4 are available.



Exchangeable front panel

Some housing widths are also available with an exchangeable front panel. It allows you to cover adjusting and indicating elements. This front panel is available in coloured or transparent versions.

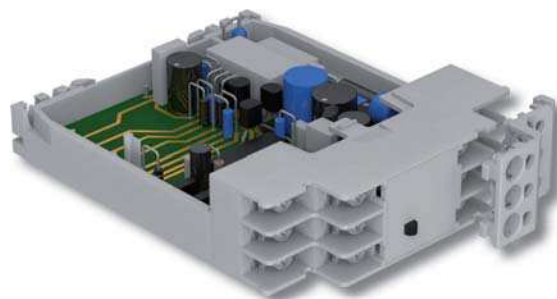

PCB integration

Guiding ribs allow for an easy accommodation of horizontal or vertical PCBs. An additional PCB parallel to the housing front is especially suitable for the accommodation of adjusting and indicating elements.



Modularity

Widths from 22.5 mm to 150 mm allow an optimal adjustment in size.

KO 4070

Innovative compact housing

The electronic housings of this compact range are the perfect shell for space-saving devices. Available in widths from 12.5 mm to 28 mm, they provide up to 16 terminals. Guides inside the housing allow for a convenient accommodation of PCBs in up to three tiers. PCBs can be reliably connected on mechanically solderable double pins of the terminal blocks.



Connection system

This housing provides up to 16 box terminals with captive plus-minus screws.



Variable terminal quantity

This compact housing provides three different terminal quantities as standard and thus allows you to adjust it easily to your application.



Exchangeable front panel

These housings are also available with an exchangeable front panel. It allows you to cover adjusting and indicating elements. This front panel is available in coloured or transparent versions.



PCB integration

Guides allow for a convenient accommodation of PCBs in up to three tiers.

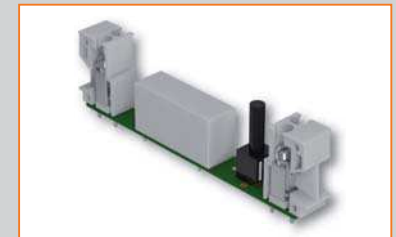

Solderable by machines

The terminal blocks can be plugged or cost-efficiently soldered together with control elements and components on PCBs in a single pass. All common mechanical solder technologies are suitable for this.



Different sizes

These housings are available in the widths 12.5 mm, 20.5 mm, and 28 mm and in the heights 60 mm, 75 mm, and 90 mm.

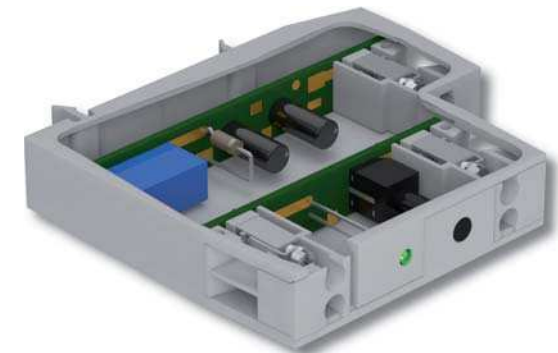

KU 4000 distribution housings with a depth of 55 mm and KO 4900 switch cabinet housings with a depth of 97 mm

These housing ranges meet all the requirements for advanced building automation. Their design variety allows you to also solve individual requirements without any problems. The housing size can also be adjusted to specific applications by fine steps. Thus, the housing ranges cover all common widths from 8.8 mm to 140 mm. Apart from conventional captive screw-type terminals, cage clamps are also available for the device connection, which allows for a very efficient device installation. And if higher current intensities are possible, you can use heavy-duty terminals up to a rated current of 50 A. For the connection and communication with other devices and systems, a variety of connectors are, of course, also available such as bus connectors, KNX (EIB), RJ-45, etc. These housings are designed for both top-hat-rail mounting and screw-type mounting.



Modularity

Widths from 8.8 mm to 140 mm allow for a fine graded size adjustment.



Two depth sizes

Distribution housings of the KU 4000 range have a fitting depth of 55 mm. The switch cabinet housings of the KO 4900 range have a fitting depth of 97 mm.



Connection system

Conventional, captive screw-type terminals, cage clamps, heavy-duty terminals and BUS connectors are possible. Two conductors can be connected to the same terminal. Non-used terminal points can be closed with blind plugs or moulded skins in the hood.

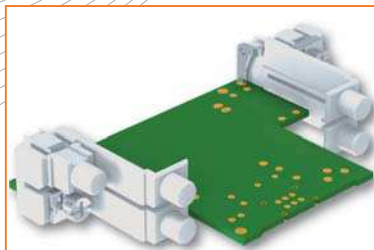

Solderable by machines

Mechanically solderable terminal blocks allow for an efficient soldering together with other components on PCBs. An additional stranded wire terminal is also possible.

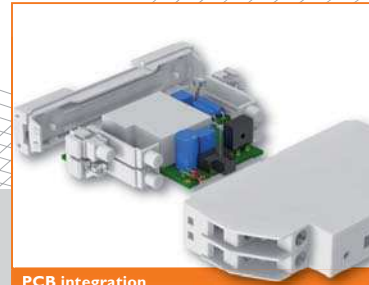
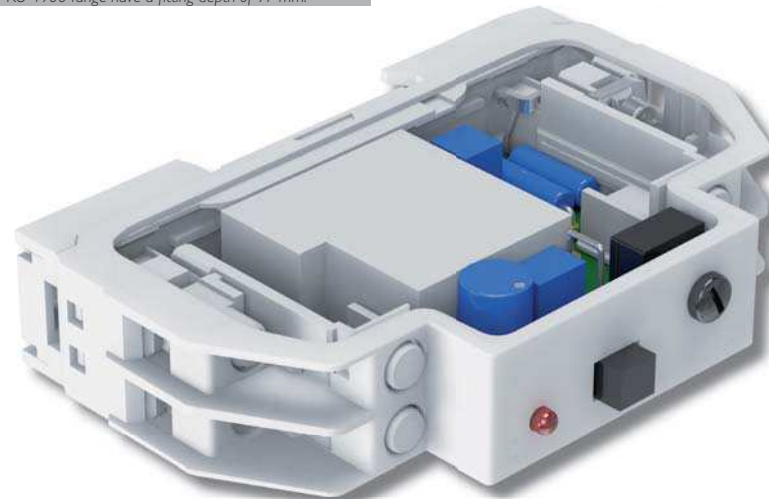

PCB integration

Accommodation options for horizontal and vertical PCBs and any combinations of them provides more flexibility in the device design.



Module housings

These housings with a width of 70 mm or 140 mm can be equipped with one or two plug-type module housings with a transparent hinged front panel.

Many options:

- ▶ **Individual housing openings**
For an optimal customisation to specific requirements, it is possible to manufacture housings with individual openings, e.g. ventilation slots for better heat dissipation or for bus connectors.
- ▶ **Exchangeable front**
It protects adjusting and indicating elements and is available as a transparent version or in the colour of the housing.
- ▶ **Plug-type module housings**
Optional module housings accommodate PCBs and allow the replacement of complete functional units. Thus, these housings are perfect for the integration of fieldbus-ready devices. By the replacement of the module housing, it is easy to adjust the device to a fieldbus system.
- ▶ **Earthing spring**
An optionally integrated earthing spring below the housing bottom provides for improved EMC properties. When the housing is snapped on the DIN rail, the PCB is automatically connected to the DIN rail.

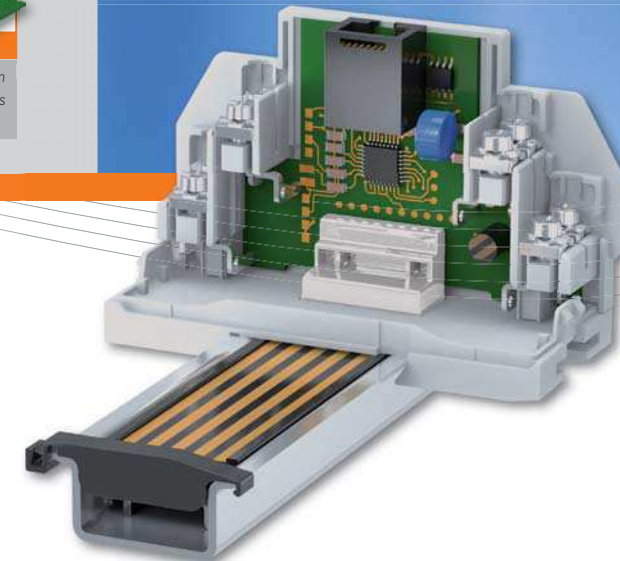

KU 4100

Versatile distribution housing with a 70 mm depth

This housing range provides all the advantages of the KU 4000 range and covers all the common widths from 17.5 mm to 140 mm. The special highlights of these electronic housings include their variable connection systems. Thus, all common terminal technologies can be used and, of course, combined with each other. Partly assembled and terminal-free versions are also available. With its modern style and its various options, this housing range is also perfect for all future-oriented applications in building automation.

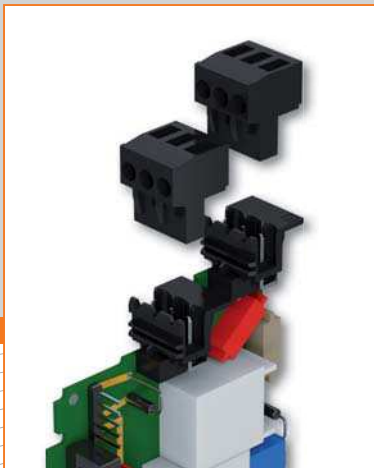

Connection system

All common terminals and any combinations from them as well as bus connectors are possible. For current carrying capacities up to 32 A.



Vertical PCB fitting

Accommodation options for horizontal and vertical PCBs and any combinations of them provides more flexibility in the device design.

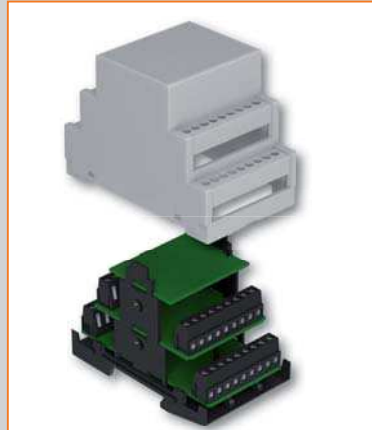

Horizontal PCB fitting

Horizontal PCBs can be fitted on up to 3 tiers. Thus, this housing range provides sufficient space for the implementation of your ideas.

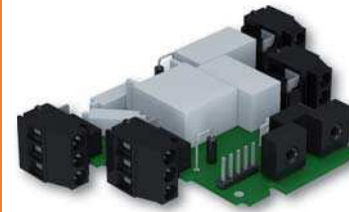
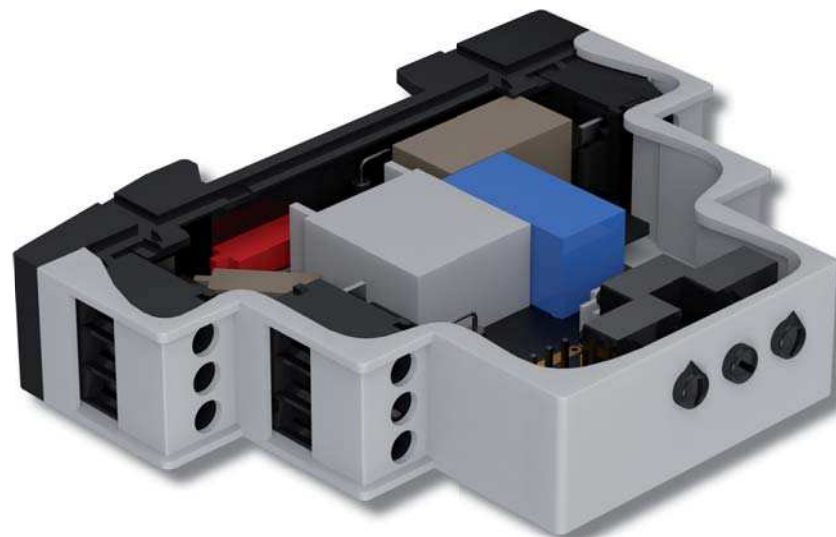

Solderable by machines

Mechanically solderable terminal blocks allow for an efficient soldering together with other components on PCBs.



Modularity

Widths from 17.5 mm to 140 mm allow for a fine graded size adjustment. Control and indicating components can also be integrated as desired.

Many options:

- ▶ **Individual housing openings**
For an optimal customisation to specific requirements, it is possible to manufacture housings with individual openings, e.g. ventilation slots for better heat dissipation or for bus connectors.
- ▶ **Sealable hinged cover**
It is transparent and protects built in adjusting and indicating components in the front area.
- ▶ **Earthing spring**
An optionally integrated earthing spring below the housing bottom provides improved EMC properties. When the housing is snapped on the DIN rail the PCB is automatically connected to the DIN rail.

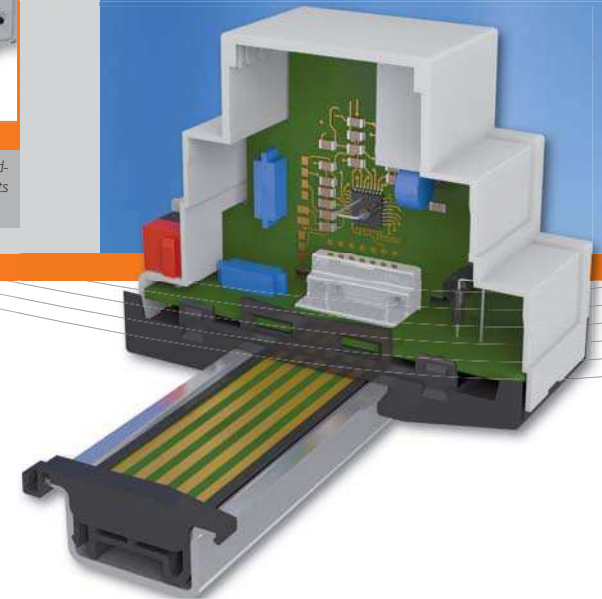

Housing solutions made by DOLD - as individual as your application



Specific housing openings

Do you need specific openings in your housing, e.g. for control elements, fibre optics or connectors such as Ethernet? This type of openings in housings can be milled or made with inserts in the injection moulding die according to your specific requirements.



Complete range of accessories

In addition to your specific housing, we also offer the appropriate accessories such as a mounting rail bus (In-Rail Bus), optical fibres in various lengths, rotary buttons with various potentiometer retainers as well as EIB sockets and –solder pins.

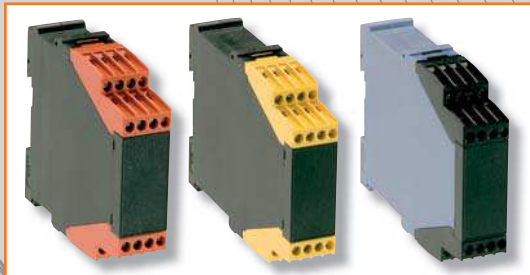

A choice from many colours

DOLD housings are available in various standard colours. On top of that, many special colours are possible too.



Housing labelling

We can use all common labelling technologies to label your housings according to your desires, e.g. company logo and device identification. Also laser labelling is possible.

Sheet metal housing solutions

For many decades, DOLD's custom-made products have been renowned for their precision and reliability. With experienced employees and advanced technology, DOLD sets the standards for the high demands of our customers.

Our services include the manufacturing of both high-quality sheet metal parts from steel, stainless steel and aluminium ready for installation and also complex modules for a great variety of applications. We manufacture small, medium and large lots on the highest technical level according to your wishes and ideas, sketches, drawings and samples.



What can we do for you?

Challenge us. We look forward to it!

High diligence was used to create this document. However, E. Dold & Söhne KG cannot be held liable for any errors. In particular, any liability for damage that may result from the application of the technical description is excluded. Subject to alterations.

DOLD



E. DOLD & SÖHNE KG

Post box 1251 • D-78114 Furtwangen
Phone +49 7723 6540 • Fax +49 7723 654356
gv-vertrieb@dold.com • www.dold.com