

STS/K-System Benefits

- EU-Test certificate according to the directive 2006/42/EG, annex IX
- For safety applications up to PLe/Category 4 according to EN/ISO 13849-1
- Modular and expandable system
- Rugged stainless steel and plastic design
- Wireless mechanical safeguarding
- Easy installation through comprehensive accessories
- Protection against lock-in
- Coding level low, medium, high according to DIN EN ISO 14119:2014-03

Features

- Actuator module with an insertion opening
- Module expansions possible below and above the module
- Can be coded
- Choice of direction in 4 increments of 90°
- Module with (compared to actuator models B/K) inverted function
- Especially suited for difficult installation positions or additional actuator monitoring
- This module is also available in stainless steel

Installation Examples

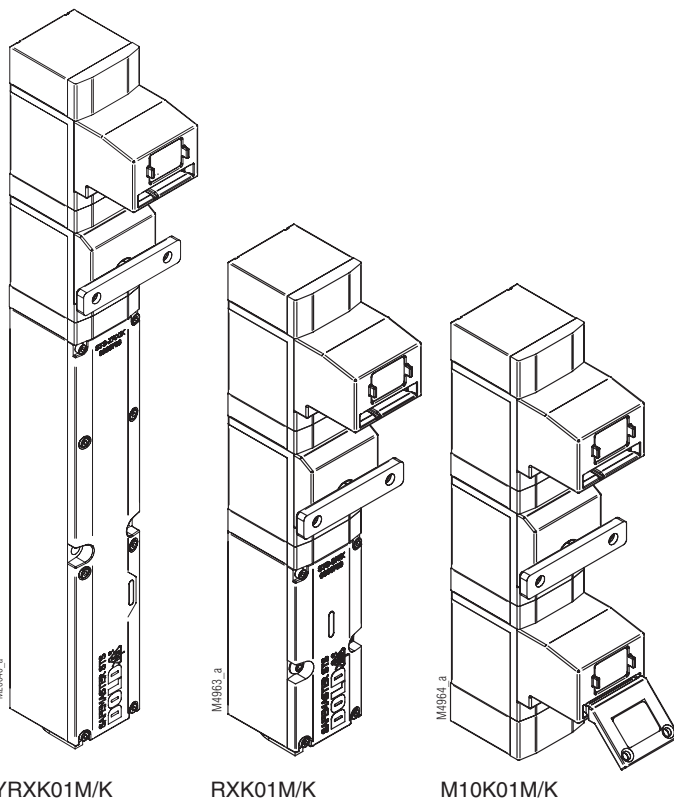

Approvals and Markings



Application

Actuator modules K/K is assembled together with other modules into an STS/K unit and used in connection with an actuator. The actuator modules are then always part of the STS/K unit and connected with the stationary part of a separating guard while the actuator is mounted to the movable part of a separating guard. The actuator modules can be installed in 4 positions on the STS/K unit, each turned by 90°. In hostile ambient conditions stainless steel SAFEMASTER STS units have to be used!

ATTENTION !



Mechanical function modules can be installed above and/or below the key module!

Electrical modules can only be installed below the key module!

Design and Operation

The actuator module K/K offers the option of inverting SAFEMASTER STS/K functions. Externally, it is identical to the actuator module B/K, but it has an inverse direction of action. This feature allows for an inverse structure of STS/K units with other monitoring functions. Standard STS/K units and inverse functional units can be combined in a key transfer system without any problem.

Example for inverting a function

With the mechanical interlock M10A/K the unlocking of the actuator in the actuator module A/K takes place by the introduction of the matching key into the key module 10/K. The actuator module is then positioned above the key module.

The MK01M/K unit has the same functionality. However, with this unit the actuator module K/K with inverting function is located below the key module 01/K. For some local conditions this design sequence may be beneficial.

Function Inversion with Electrical Monitoring Option

A part from the sequential inversion of the modules used in the module combination the integration of the actuator module K/K offers an electrical monitoring option of the actuator. If, for example, a guard door position shall not only be monitored mechanically but also electrically, the RXK01M/K is the suitable unit. To unlock the actuator, the matching key must be inserted into the key unit above. Only after that can the actuator be removed. With the actuator removal several contacts of the switch module RX are actuated at the same time.

In contrast to the RXK01M/K the switch contacts with the normally functioning RX10A/K unit monitor the key insertion and not the removal of the actuator. Therefore there is no possibility of checking with this unit whether the access was actually opened.

The contacts of switch module RX/K can be used both as signal contacts and safety feature. With a safety-related contact the use of a safety switching device with changeover contact principle or antivalence switching is required.

When using the actuator module K/K with inverting function, the other functions such as key change are preserved. The identification of the STS/K unit is done from the bottom to the top as always. However, the operating sequence is inverted.

Function Inversion with Locking Modules

The actuator module K/K can also be combined with solenoid lock module, for instance, the YRH/K.

In this case the solenoid lock module no longer works as a door closure but rather unlocks mechanically functioning units for actuator removal. This combination is suitable for systems with a very high risk of being locked in where escape unlocking cannot be used; it is also used for escape sluices. The contacts of the solenoid lock module YRH/K can be used both as signal contacts and safety-related. With a safety-related contact the use of a safety switching device with changeover contact principle or antivalence switching is required.

Example YRHK01M/K

This STS/K unit functions similar to the MK01M/K, but the actuator can only be inserted into the actuator module if a signal is applied to the solenoid of the locking module unit

Example YRHK11M/K

This STS unit functions similar to the MK11M/K, but the actuator can only be inserted into the actuator module when a signal is applied to the solenoid of the solenoid lock unit. After that the key can be changed.

Circuit Diagrams (RXK01M/K)

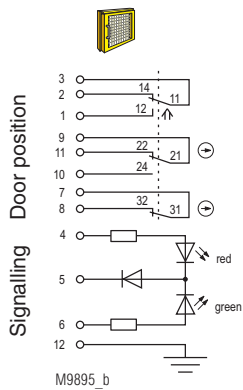

Fig. 1:
Locking module activated:
Key (top) removed,
Actuator (bottom) inserted,
Door closed

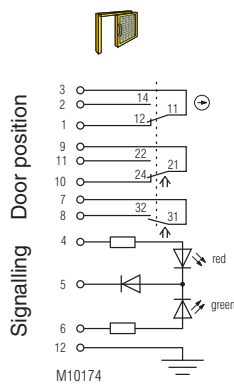

Fig. 2:
Locking module deactivated:
Key (top) inserted,
Actuator (bottom) removed
Door unlocked and open

Switching logic

		Fig. 1	Fig. 2
Door contacts	3	2	■
	3	1	■
	9	11	■
	9	10	■
	7	8	■

■ closed
□ open

Circuit Diagrams (example YRHK01M/K)

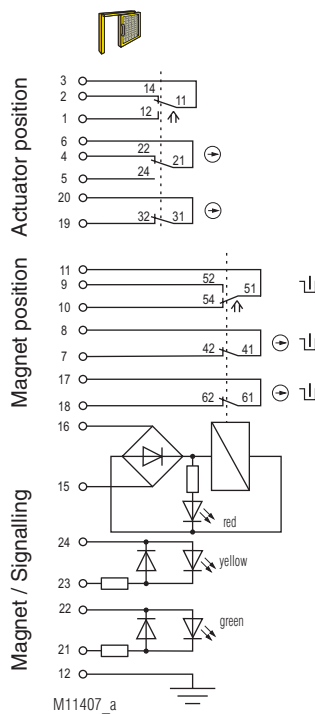

Fig. 3:
Blocking function deactivated:
Magnet locked, actuator
removed and not pluggable
Door open

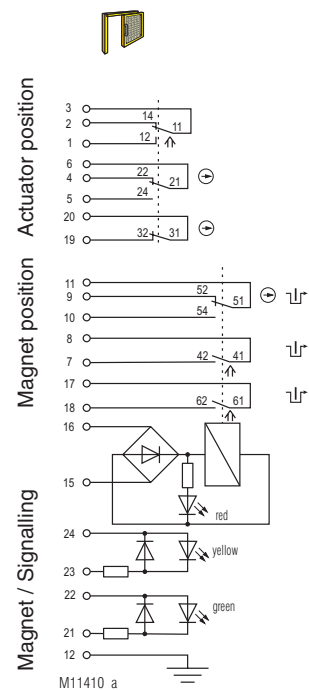
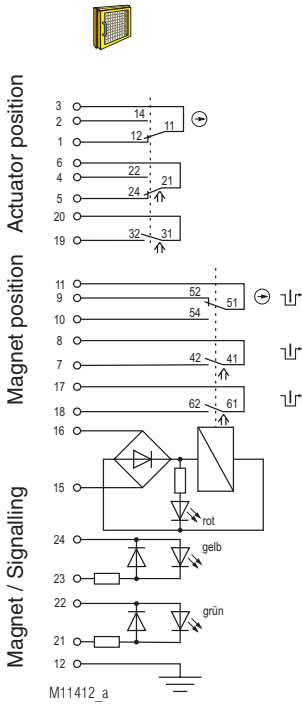

Fig. 4:
Blocking function when
deactivated:
Magnet released, actuator
removed and pluggable
Door open

Circuit Diagram (example YRHK01M)



Switching logic

			Fig. 3	Fig. 4	Fig. 5
Actuator contacts	3	2			
	3	1			
	6	4			
	6	5			
Magnet contact	11	9			
	11	10			
	7	8			
	17	18			
Control signal Magnet	15	16			

closed
 open

The state shown in **Figure 5** does not depend on the control signal of the magnet.
 If the control signal is applied and the actuator removed the locking module drops to the state of **Figure 4**.
 If no signal is applied and the locking module is removed the control module changes to the state of **Figure 3**.

Fig. 5:
 Blocking function when deactivated:
 Magnet released, actuator inserted, key removed or inserted, door closed

Alternative STS/K Units

The following overview shows some examples of alternative STS/K units with normal and inverted functions:

normal	inverted
M10A/K	MK01M/K
M11A/K	MK11M/K
M12A/K	MK21M/K
M10B01M/K	M10K01M/K
M10B02M/K	M20K01M/K
RX10A/K	RXK01M/K

The units specified offer the same functions, only the operating sequence is different. In the event of switch / locking modules the monitored module logically changes.

Diagnostic Coverage (DC)

When using an actuator module K/K above an electrical STS/K module such as switch module RX/K or solenoid locking module YRH/K, the diagnostic coverage (DC value) needs to be determined by the mechanical STS module only in the first step.

To determine the diagnostic coverage of a STS/K unit with inverted function an overview of the functionally identical STS/K units with normal function is provided in **Alternative STS/K Units**. The respective diagnostic coverages can be found in the SAFEMASTER STS design guide.

The diagnostic function of the electrical STS module is to be considered as 1 or 2-channel system, depending on the design of the circuits. The DC value of the mechanical STS component is included in the calculation of the diagnostic coverage according to EN ISO 13849-1 to assess the key transfer function as subsystem. For more information on this subject refer to the SAFEMASTER STS design guide.

Technical Data

Enclosure: PA + GF
 Internal parts and inserting slots: Stainless steel V4A / AISI 316 / AISI 630
 Ambient temperature: - 25 °C bis + 60 °C
 Application: only as part of a unit of the SAFEMASTER STS series

ATTENTION !



To avoid wrong usage (e.g. by overload, mounting position or usage in acid, alkaline or other hostile ambient conditions) the limitations of the product have to be observed. Please check in advance if your application requires the usage of the more robust stainless steel model of SAFEMASTER STS. The requirements of the mounting and operating instruction must be fulfilled.

Dimension [mm]

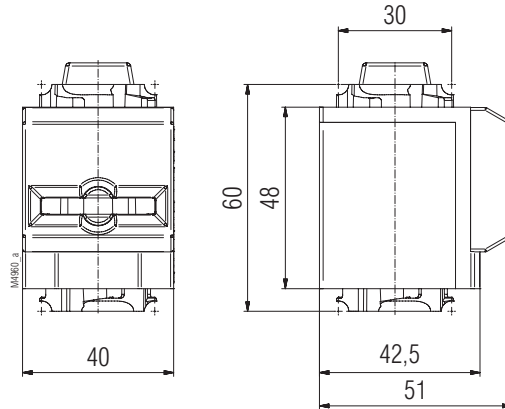

Actuator module K/K

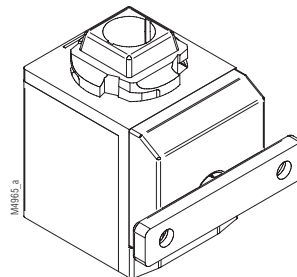

Actuator module K/K

Variants and Accessories

Devices with several actuators

If several actuators are needed for an application, for instance, for the implementation of categories 4 or 3, several actuator modules K/K can also be installed next to each other. However, they cannot be connected with an actuator module A/K as is the case with normally functioning versions. An example of an STS/K unit with double actuator is the MKK01M /K or the RXKK01M/K. When connecting two actuator modules, care should be taken that the introduction of both actuators into the associated actuator modules takes place at the same time. As an option, the bottom actuator can be introduced first and then the top one later. If the actuators are both coded the same, it has no significance for the assembly and function of the STS/K unit.

Ordering Designation

Actuator module K/K
 Article number: 0066793

