

**Presentation in the deactivated condition:**  
1st key inserted; Actuator and 2nd key removed

### STS/K-System Benefits

- EU-Test certificate according to the directive 2006/42/EG, annex IX
- For safety applications up to PLe/Category 4 according to EN ISO 13849-1
- Modular and expandable system
- Rugged composite version of stainless steel and plastic design
- Wireless mechanical safeguarding
- Combines the benefits of safety switch, solenoid locking and key transfer in a single system
- Easy installation through comprehensive accessories
- Protection against lock-in
- Coding level low, medium, high according to DIN EN ISO 14119:2014-03

### Features

- The unit is particularly suitable for applications with:
  - Full body access (lock-in danger)
  - Optional key removal
  - Several secured entries
  - Rugged ambient conditions
- This unit is also available in stainless steel

### Approvals and Markings



### Function

Safety switch with forced key inserting and electromechanic blocking of the key. Only when a signal is connected to the magnet, the key can be inserted.

### Application

To secure separating guards such as safety gates and hoods in machine and plant engineering.

### Design and Operation

Solenoid locking units prevent opening of separating guards and keep them closed as long as their is a risk of injury in the secured plant.

#### Attention!



Hazards must be ruled out before a key can be inserted and the movable part of the guard can then be opened!

The STS/K solenoid locking unit is to be integrated into a system and connected with a control unit so that the hazardous machine can run only when the guard is locked and closed.

An access can only be opened after a release signal was sent by the machine control to the YRX10B01M/K solenoid locking unit. The actuator can only be removed from actuator module and the access opened after inserting the key in the key module. Optionally the second key can be removed. The Key operation of the first key is forced. Key entry is blocked when the door is open. The key can be removed again after the access was closed again. Only after removing the key is the solenoid locking activated again and the machine can be restarted.

Key and magnet position are monitored by separate contacts.

YRX10B01M/K is usually used in the system in connection with additional STS/K units and SAFEMASTER products (e.g. release by speed monitor UH 5947, standstill monitor LH 5946 or speed/standstill monitor BH 5932). The second key with forced removal can be used as protection against lock-in or for the operating release of additional units.

## Circuit Diagrams

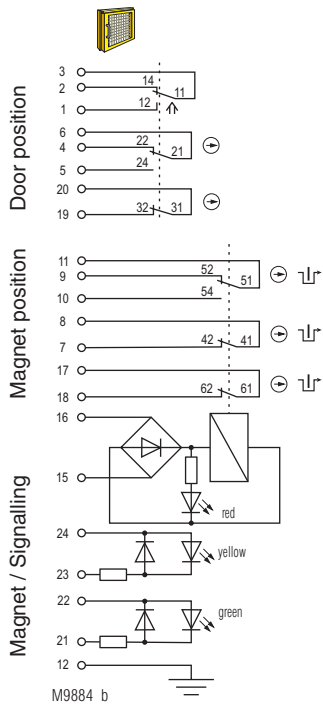

**Fig. 1:**  
Solenoid locking activated:  
Magnet locked, 1st key  
removed, actuator and  
2nd key inserted,  
Door closed

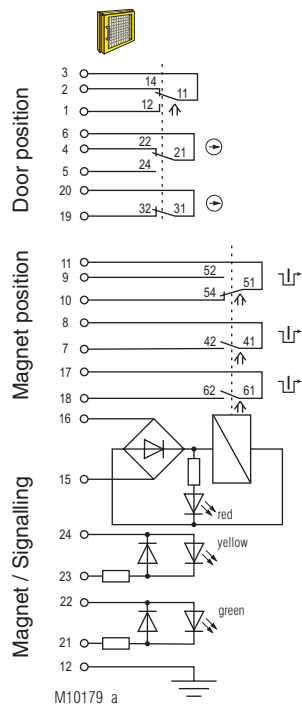

**Fig. 2:**  
Solenoid locking deactivated:  
Magnet released, optionally 1st  
key inserted, actuator and key  
inserted,  
Door closed

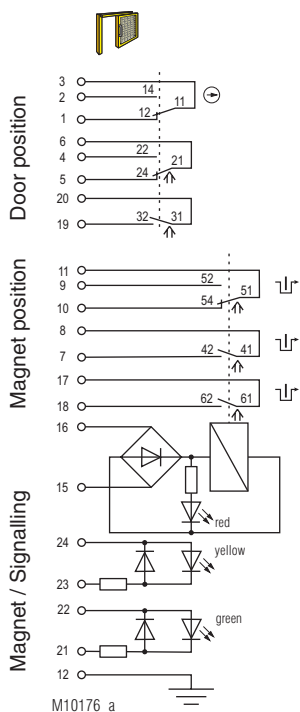

**Fig. 3:**  
Solenoid locking deactivated:  
Magnet released,  
1st key inserted,  
Actuator removed,  
Door open,  
optionally 2nd key removed

		Fig. 1	Fig. 2	Fig. 3
Door contacts	3	2		
	3	1		
	6	4		
Magnet contact	6	5		
	19	20		
	11	9		
Control signal Magnet	11	10		
	7	8		
	17	18		
U <sub>N</sub>				
15	16			

■ closed  
□ open

The state shown in **Figure 3** does not depend on the control signal of the magnet.  
If the control signal is applied and the key inserted the solenoid locking changes to the state of **Figure 2**.  
If no signal is applied and the key inserted the solenoid locking changes to the state of **Figure 1**

## Technical Data

Enclosure:	PA + GF
Internal parts and inserting slots:	Stainless steel V4A / AISI 316 / AISI 630
Degree of protection:	IP 65
Temperature range standby current principle:	- 25 °C to + 38 °C
Temperature range load current principle:	- 25 °C to + 38 °C
Storage temperature:	- 25 °C to + 60 °C
Mechanical principle:	Rotating axis with redundant actuator
Connection method:	Cage clamp terminals
min. connection cross-section:	0.25 mm <sup>2</sup>
max. connection cross-section:	0.75 mm <sup>2</sup>
Cable entry:	1 x M20 x 1.5
B10 <sub>10</sub> :	2 x 10 <sup>6</sup> switching cycles
Electrical service life:	5 x 10 <sup>6</sup> switching cycles
Locking force:	min. 2000 N
Shearing force:	depending on actuator
Solenoid locking principle:	Standby current, failure locking-proof
Magnetic principle:	Standby current or load current
min. operating speed:	100 mm/s
max. operating speed:	250 mm/s
max. switching frequency:	360/h
Operating mode:	100% ED
Nominal voltage U <sub>N</sub> :	AC/DC 24 V
Nominal voltage range:	0.85 ... 1.1 U <sub>N</sub> (see solenoid derating graph)
Power consumption:	6 W
Rated impulse voltage:	0.8 kV
Rated insulation voltage:	≤ 50 V
Overvoltage category:	III
Pollution degree:	2
Max. operating current	
Standby current principle:	2 A
Load current principle:	1 A
Contacts	
Door position:	1 NC contact, 2 antivalent changeover contacts
Magnet position:	2 NC contacts + 1 changeover contact
Switching principle:	Changeover contact with forced-opening snap-action switch

Utilization category of switching elements to AC 15:	1 A
to DC 13:	0.5 A
Contact material:	Ag / AgSnO <sub>2</sub>
Short circuit strength, max. fusing:	2 A gG
Rated conditional short circuit current:	1000 A
Indicator:	LED red/green, separate selection possible
Test principles:	EN ISO 13849-1:2008 DIN EN ISO 14119:2014-03 EN 60947-5-1:2005 GS-ET-15:02.2011 GS-ET-19:02-2011 GS-ET-31:02-2010
Intended use:	up to max. cat. 4, PL e according to EN ISO 13849-1 according to DIN EN 50041
Mounting:	IEC EN 60947-5-1 Appendix K
Contact elements:	
Additional requirement for cat. 4 structure (as single unit):	Add 2nd actuator module Type YRX10KK01M/K

Diagnostic coverage (DC), (mechanical):

### Logic and output

YRX10B01M/K:	<b>cat. 2</b>	<b>cat. 3</b>	<b>cat. 4</b>
YRX10 BB01M/K:	60 %	90 %	99 %
Protection against faults of common cause:			
Repair and replacement:			
Test intervals:			
for PL a to d:			
for PL e:			

see table in STS design guide by manufacturer only
min. once a year
min. once a month

## Technical Data

### ATTENTION !



To avoid wrong usage (e.g. by overload, mounting position or usage in acid, alkaline or other hostile ambient conditions) the limitations of the product have to be observed. Please check in advance if your application requires the usage of the more robust stainless steel model of SAFE-MASTER STS. The requirements of the mounting and operating instruction must be fulfilled.

## Solenoid derating graph

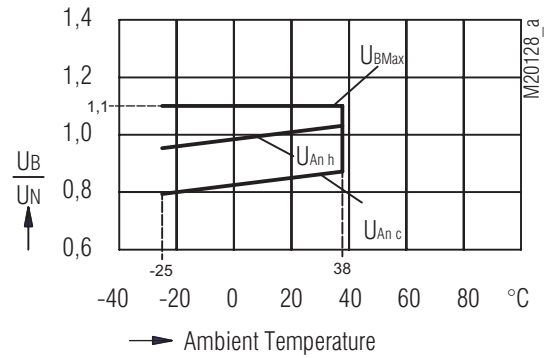

$U_{BMax}$  maximum power supply dependent upon temperature  
 $U_{An c}$  response voltage at coil temperature = ambient temperature  
 $U_{An h}$  response voltage at preceding agitation at 1.1 x  $U_n$

## Ordering Example

STS- Y R X B 01 M /K

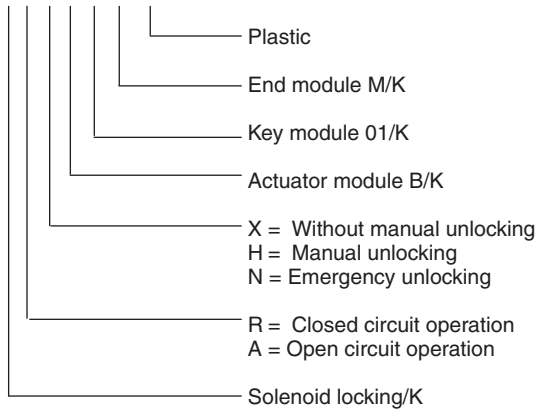

## Variants and Combination Options

Because of their modular design the basic units of the SAFEMASTER STS/K System can be combined and expanded according to customer requests. This allows for a variety of possible units and functions.

### Overview of the basic units

Functions	Safety switches design type 2	Safety switches design type 2 with solenoid lock	Mechanical units design type 2	Mechanical units with electrical monitoring	Mechanical units with electrical release
Units with standard function	SXBM/K	ZRHBM/K	M10BM/K	RXK01M/K RX10BM/K	YRXKM/K YRXK01M/K
Units with mechanical lock and forced key extraction	SX01BM/K	ZRH01BM/K	M11BM/K	RXK11M/K RX11BM/K	YRX10BM/K YRX11BM/K
Units with optional key extraction	SXB01M/K	ZRHB01M/K	M10B01M/K	RX10B01M/K RX10K01M/K	YRX10B01M/K
Units without actuator	SX01M/K	ZRH01M/K	M12M/K	RX11M/K	YRX11M/K

For additional information refer to the data sheets of the individual modules and other basic units.

### Data sheets

Switching module YRX/K  
 Key module 01/K / 10/K  
 Actuator module B/K  
 End module M/K



Take advantage of the advice of the **E. DOLD & SÖHNE KG** specialists regarding the choice of units and combination of a system.

Dimensional Drawing [mm]

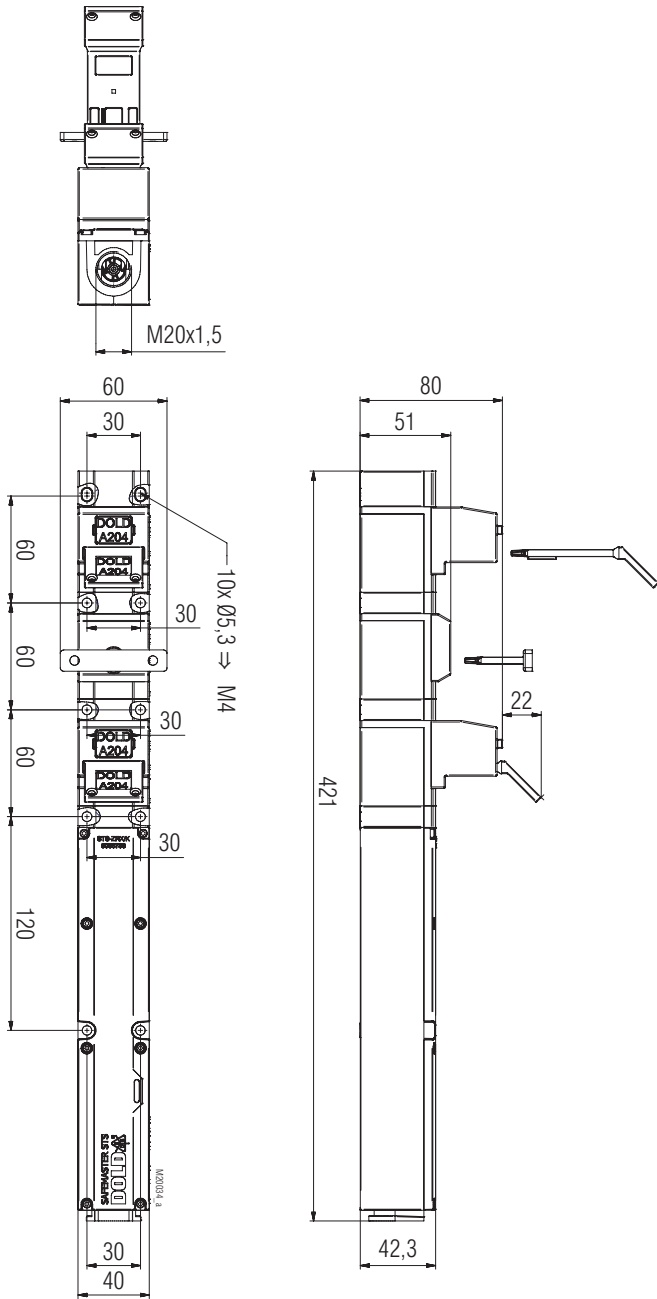

YRX10B01M/K  
Clearance tolerances ± 2%

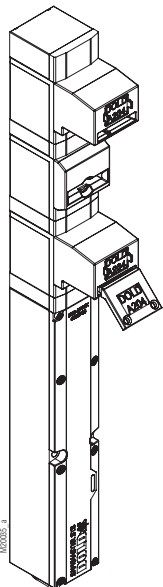

YRX10A/K