

# Socket for DOLD Safety relays

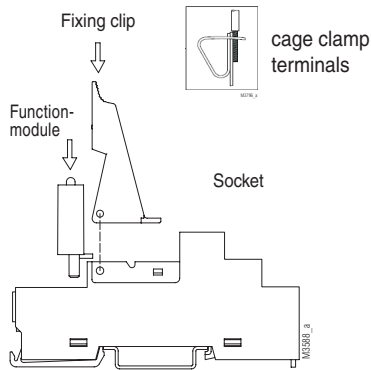

## OA/OW 5668, OA/OW 5669, OA 5672, OA 5682, OB 5694



ET 1415.047

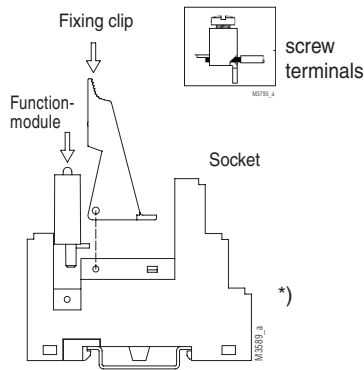

ET 1415.044  
safety separation between relay coil and contact

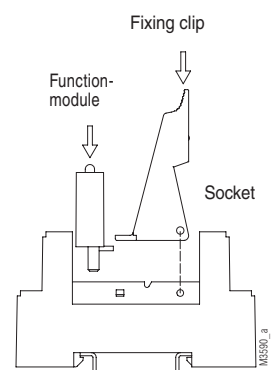

ET 1415.041

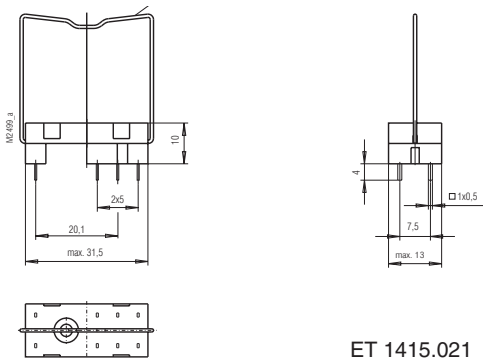

ET 1415.021

### Terminal designation

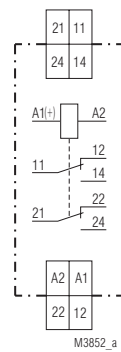

ET 1415.041

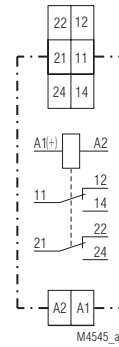

ET 1415.044  
ET 1415.047

## OA 5670

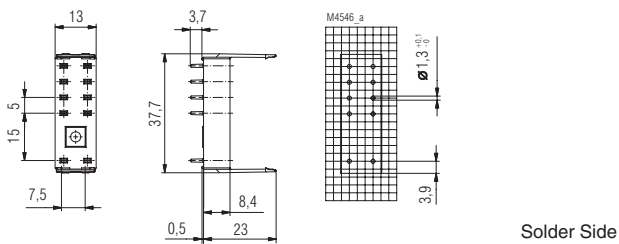

Solder Side

## OA 5601

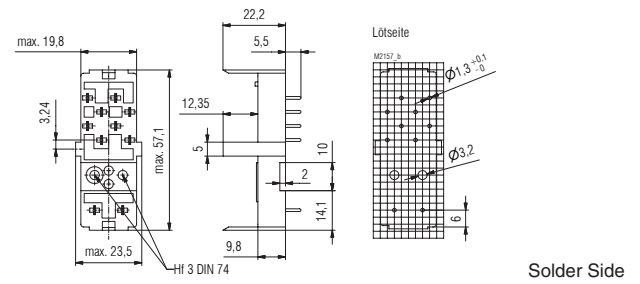

Solder Side

## OA 5602

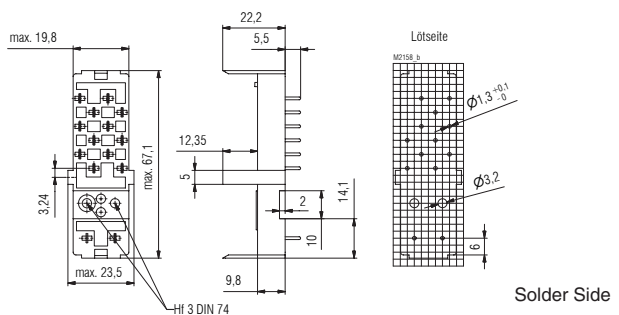

Solder Side

## OA 5603

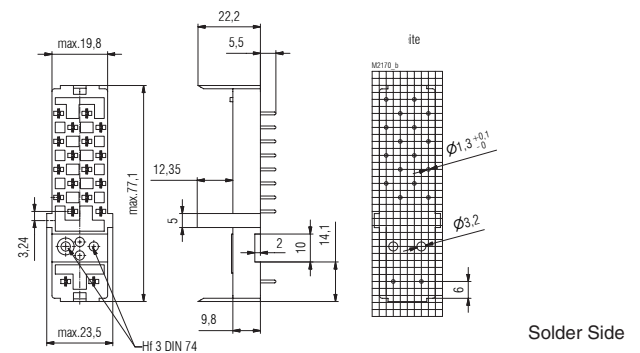

Solder Side

# Socket for DOLD Safety relays



## OA 5611

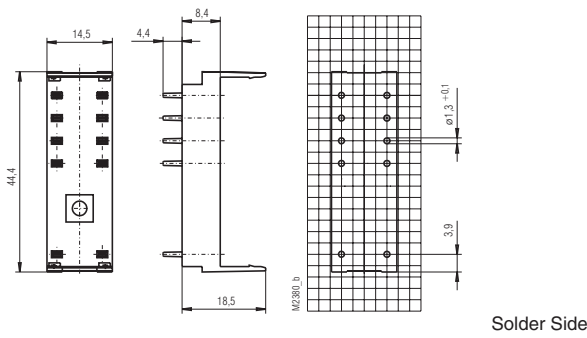

## OA 5612

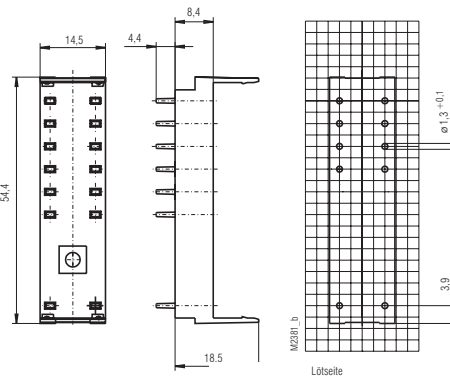

## OA 5621

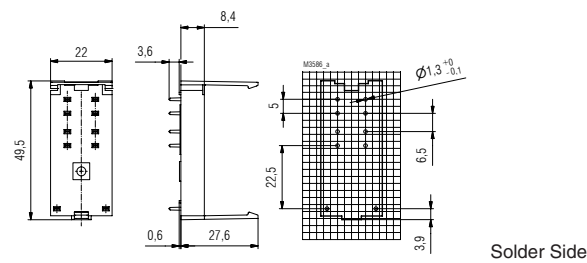

## OA 5622

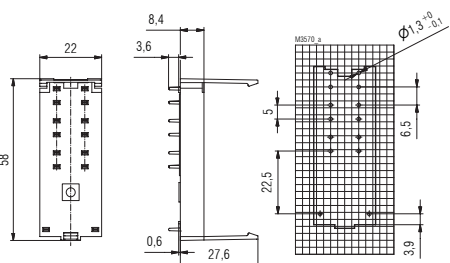

## Order references

Relay type	Socket	Fixing clip	Function modul
OA/OW 5668, OA/OW 5669 OA 5672, OA 5682 OB 5694	ET 1415.021 ET 1415.044 ET 1415.047 ET 1415.041	ET 1415.025 included included included	ET 1415.913 (DC, with free-wheeling diode and green LED) ET 1415.911 (DC, with free-wheeling diode and red LED) or ET 1415.912 (AC/DC, with green LED)
OA 5601	ET 1415.011	-	
OA 5602	ET 1415.012	-	
OA 5603	ET 1415.013	-	
OA 5611	ET 1415.031	-	
OA 5612	ET 1415.032	-	
OA 5621	ET 1415.035	-	
OA 5622	ET 1415.037	-	
OA 5670	ET 1415.034	-	