

Valid as of version
V 3.01.XX (Device firmware, HART 5)
V 3.07.XX (Device firmware, HART 7)

Description of Device Functions

Proline Promass 83

Coriolis flowmeter

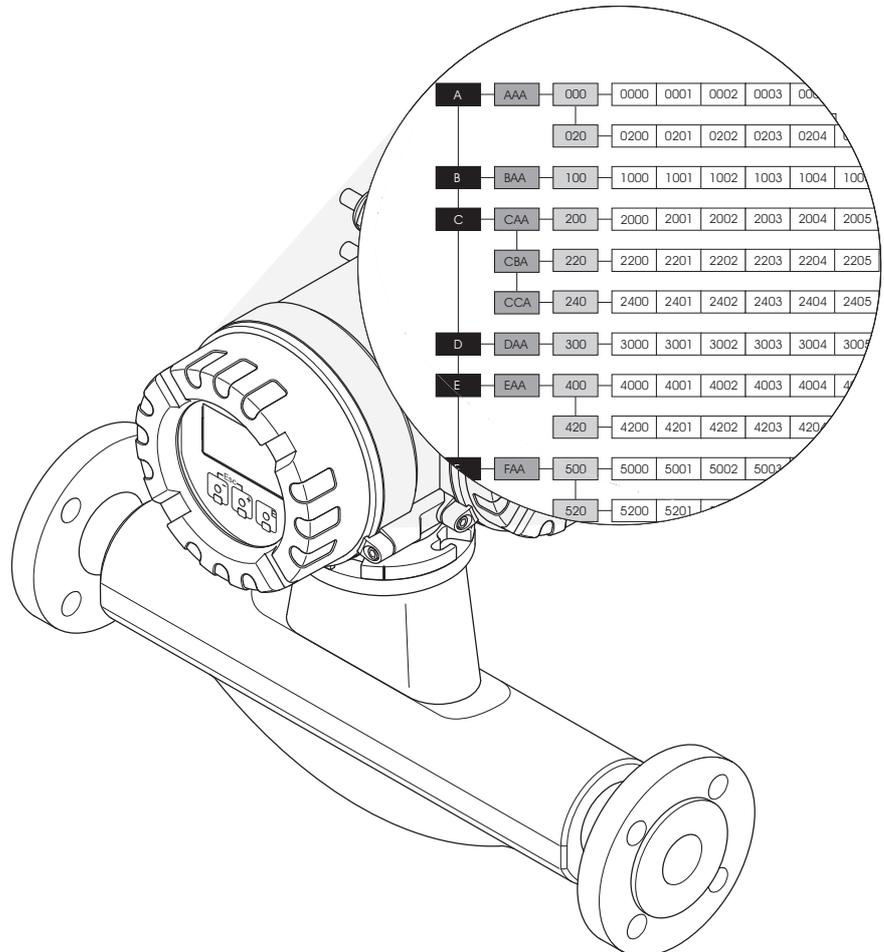

Table of Contents

1	Notes on using this Manual	7
1.1	Using the table of contents to locate a function description	7
1.2	Using the graphic of the function matrix to locate a function description	7
1.3	Using the index of the function matrix to locate a function description	7
2	Function matrix	8
2.1	General layout of the function matrix	8
2.1.1	Blocks (A, B, C, etc.)	8
2.1.2	Groups (AAA, AEA, CAA, etc.)	8
2.1.3	Function groups (000, 020, 060, etc.)	8
2.1.4	Functions (0000, 0001, 0002, etc.)	8
2.1.5	Codes identifying cells	9
2.1.6	Designation of device software	9
2.2	Function matrix Proline Promass 83	10
3	Block MEASURED VARIABLES	11
3.1	Group MEASURING VALUES	12
3.1.1	Function group MAIN VALUES	12
3.1.2	Function group ADDITIONAL VALUES	13
3.2	Group SYSTEM UNITS	17
3.2.1	Function group CONFIGURATION	17
3.2.2	Function group ADDITIONAL CONFIGURATION	20
3.3	Group SPECIAL-UNITS	22
3.3.1	Function group ARBITRARY UNIT	22
4	Block QUICK SETUP	25
4.1	Setup Commissioning	27
4.2	Pulsating flow Setup menu	29
4.3	Gas measurement Setup menu	31
4.4	Batching Setup menu	32
4.5	Data back-up/transfer	34
5	Block USER INTERFACE	35
5.1	Group CONTROL	36
5.1.1	Function group BASIC CONFIGURATION	36
5.1.2	Function group UNLOCKING/ LOCKING	39
5.1.3	Function group OPERATION	40
5.2	Group MAIN LINE	41
5.2.1	Function group CONFIGURATION	41
5.2.2	Function group MULTIPLEX	43
5.3	Group ADDITIONAL LINE	45
5.3.1	Function group CONFIGURATION	45
5.3.2	Function group MULTIPLEX	48
5.4	Group INFORMATION LINE	51
5.4.1	Function group CONFIGURATION	51
5.4.2	Function group MULTIPLEX	54
6	Block TOTALIZERS	57
6.1	Group TOTALIZER (1 to 3)	58
6.1.1	Function group CONFIGURATION	58
6.1.2	Function group OPERATION	60

6.2	Group HANDLING TOTALIZER	61
7	Block OUTPUTS	62
7.1	Group CURRENT OUTPUT (1 to 3)	63
7.1.1	Function group CONFIGURATION	63
7.1.2	Function group OPERATION	73
7.1.3	Function group INFORMATION	74
7.2	Group PULSE/FREQUENCY OUTPUT (1 to 2)	75
7.2.1	Function group CONFIGURATION	75
7.2.2	Function group OPERATION	97
7.2.3	Function group INFORMATION	101
7.3	Group RELAY OUTPUT (1 to 2)	102
7.3.1	Function group CONFIGURATION	102
7.3.2	Function group OPERATION	107
7.3.3	Function group INFORMATION	109
7.3.4	Information on the response of the relay output	110
7.3.5	Switching behavior of the relay output	111
8	Block INPUTS	113
8.1	Group STATUS INPUT	114
8.1.1	Function group CONFIGURATION	114
8.1.2	Function group OPERATION	115
8.1.3	Function group INFORMATION	116
8.2	Group CURRENT INPUT	117
8.2.1	Function group CONFIGURATION	117
8.2.2	Function group OPERATION	119
8.2.3	Function group INFORMATION	120
9	Block BASIC FUNCTION	121
9.1	Group HART	122
9.1.1	Function group CONFIGURATION	122
	Function group INFORMATION 124	
9.2	Group PROCESS PARAMETER	125
9.2.1	Function group CONFIGURATION	125
9.2.2	Function group EPD PARAMETER	127
9.2.3	Function group REFERENCE PARAMETER	129
9.2.4	Function group ADJUSTMENT	131
9.2.5	Function group PRESSURE CORRECTION	133
9.3	Group SYSTEM PARAMETER	134
9.3.1	Function group CONFIGURATION	134
9.4	Group SENSOR DATA	136
9.4.1	Function group CONFIGURATION	136
9.4.2	Function group FLOW COEFFICIENT	137
9.4.3	Function group DENSITY COEFFICIENT	138
9.4.4	Function group ADDITIONAL COEFFICIENT	139
10	Block SPECIAL FUNCTION	140
10.1	Group DENSITY FUNCTIONS	142
10.1.1	Function group CONFIGURATION	142
10.2	Group BATCHING FUNCTION	148
10.2.1	Function group CONFIGURATION	148
10.2.2	Function group VALVE PARAMETER	154
10.2.3	Examples of setting parameters for batching processes	156
10.2.4	Function group SUPERVISION	159
10.2.5	Function group OPERATION	163
10.2.6	Function group INFORMATION	165

10.3	Group ADVANCED DIAGNOSIS	167
10.3.1	Function group CONFIGURATION	167
10.3.2	Function group ACQUISITION	168
10.3.3	Function group MASS FLOW	169
10.3.4	Function group DENSITY	170
10.3.5	Function group REFERENCE DENSITY	171
10.3.6	Function group TEMPERATURE	172
10.3.7	Function group TUBE DAMPING	173
10.3.8	Function group ELECTRODYNAMIC SENSORS	174
10.3.9	Function group OPERATING FREQUENCY FLUCTUATION	175
10.3.10	Function group TUBE DAMPING FLUCTUATION	176
11	Block SUPERVISION	178
11.1	Group SYSTEM	179
11.1.1	Function group CONFIGURATION	179
11.1.2	Function group OPERATION	181
11.2	Group VERSION-INFO	183
11.2.1	Function group DEVICE	183
11.2.2	Function group SENSOR	183
11.2.3	Function group AMPLIFIER	183
11.2.4	Function group F-CHIP	185
11.2.5	Function group I/O MODULE	185
11.2.6	Function groups INPUT/OUTPUT 1 to 4	186
12	Factory settings	187
12.1	SI units (not for USA and Canada)	187
12.1.1	Low flow cut off, full scale value, pulse value – Liquid	187
12.1.2	Low flow cut off, full scale value, pulse value – Gas	187
	Language	188
12.1.4	Density, length, temperature	188
12.2	US units (only for USA and Canada)	189
12.2.1	Low flow cut off, full scale value, pulse value – Liquid	189
12.2.2	Low flow cut off, full scale value, pulse value – Gas	189
12.2.3	Language, density, length, temperature	189

Registered trademarks

HART®

Registered trademark of HART Communication Foundation, Austin, USA

HistoROM™, S-DAT®, T-DAT®, F-CHIP®

Registered trademarks of Endress+Hauser Flowtec AG, Reinach, CH

1 Notes on using this Manual

There are various ways of locating the description of a function of your choice in the manual:

1.1 Using the table of contents to locate a function description

The designations of all the cells in the function matrix are listed in the table of contents. You can use these unambiguous designations (such as USER INTERFACE, INPUTS, OUTPUTS, etc.) to choose whichever functions are applicable to a particular set of conditions. The page references show you exactly where to find the detailed descriptions of the functions in question.

The table of contents is on →  3.

1.2 Using the graphic of the function matrix to locate a function description

This step-by-step, top-down approach starts with the blocks, the highest level, and factory down through the matrix to the description of the function you need:

1. All blocks available, and their related groups, are illustrated on →  10. Select the block (or the group within the block) which you need for your application and use the page reference to locate the information corresponding to the next level.
2. The page in question contains a graphic showing of the block with all its subordinate groups, function groups and functions. Select the function which you need for your application and use the page reference to locate the detailed function description.

1.3 Using the index of the function matrix to locate a function description

Each “cell” in the function matrix (blocks, groups, function groups, functions) has a unique identifier in the form of a code consisting of one or three letters or a three- or four-digit number. The code identifying a selected “cell” appears at the top right on the local display.

Example:

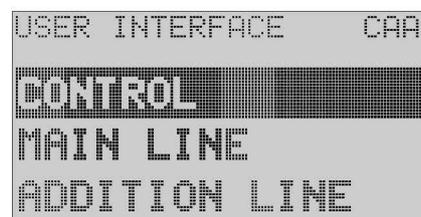

A0001653-en

The function matrix index lists the codes for all the available “cells” in alphabetic and consecutive order, complete with the page references for the corresponding functions.

The index to the function matrix is on →  191.

2 Function matrix

2.1 General layout of the function matrix

The function matrix consists of four levels:

Blocks -> Groups -> Function groups -> Functions

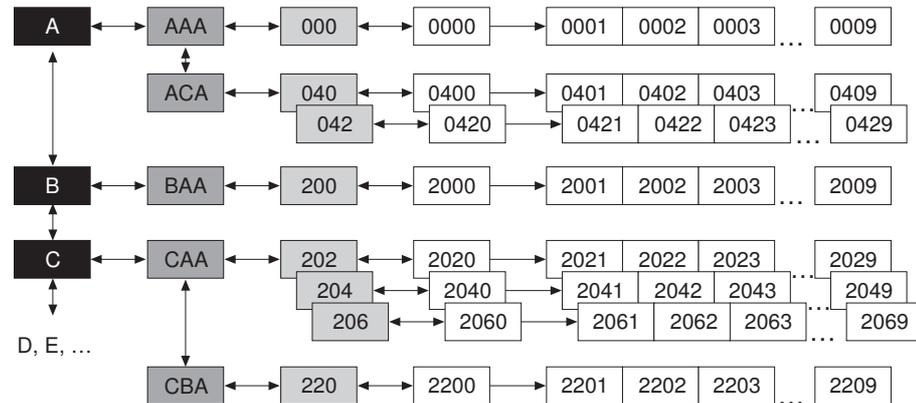

A0000961

2.1.1 Blocks (A, B, C, etc.)

The blocks are the highest-level grouping of the operation options for the device. The blocks include, for example: MEASURED VARIABLES, QUICK SETUP, USER INTERFACE, TOTALIZER, etc.

2.1.2 Groups (AAA, AEA, CAA, etc.)

A block consists of one or more groups. Each group represents a more detailed selection of the operation options in the higher-order block. The groups in the USER INTERFACE block, for example, include: CONTROL, MAIN LINE, ADDITIONAL LINE, etc.

2.1.3 Function groups (000, 020, 060, etc.)

A group consists of one or more function groups. Each function group represents a more detailed selection of the operation options in the higher-order group. The function groups in the CONTROL group, for example, include: BASIC CONFIGURATION, UN-/LOCKING, OPERATION, etc.

2.1.4 Functions (0000, 0001, 0002, etc.)

Each function group consists of one or more functions. The functions are used to operate and configure the device. Numerical values can be entered or parameters selected and saved. The functions in the BASIC CONFIGURATION function group include LANGUAGE, DISPLAY DAMPING, CONTRAST LCD, etc. The procedure for changing the language of the user interface, for example, is as follows:

1. Select the block USER INTERFACE.
2. Select the group CONTROL.
3. Select the function group BASIC CONFIGURATION.
4. Select the function LANGUAGE (here you can set the language required).

2.1.5 Codes identifying cells

Each cell (block, group, function group and function) in the function matrix has an individual, unique code.

Blocks:

The code is a letter (A, B, C, etc.)

Groups:

The code consists of three letters (AAA, ABA, BAA, etc.).

The first letter matches the block code (i.e. each group in block A has a code starting with an A __; the codes of the groups in block B start with a B __, etc.). The other two letters are for identifying the group within the respective block.

Function groups:

The code consists of three digits (000, 001, 100, etc.).

Functions:

The code consists of four digits (0000, 0001, 0201, etc.).

The first three digits are the same as the code for the function group.

The last digit in the code is a counter for the functions in the function group, incrementing from 0 to 9 (e.g. function 0005 is the sixth function in group 000).

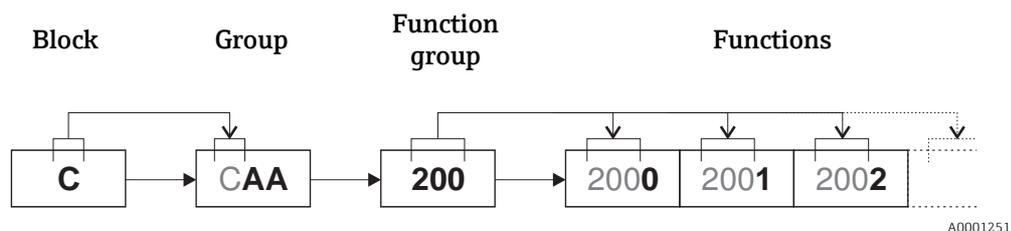

2.1.6 Designation of device software

HART 5

- Valid until software version: 3.01.XX
- Order code "Power Supply; Display", option A, B, C, D, E, F, G, H, X, 7, 8

HART 7

- Valid as of software version: 3.07.XX
- Order code "Power Supply; Display", option P, Q, R, S, T, U, 4, 5

2.2 Function matrix Proline Promass 83

BLOCKS	GROUPS	Function groups
MEASURED VARIABLES A (→ 11)	MEASURING VALUES AAA	→ → 12
	SYSTEM UNITS ACA	→ → 17
	SPECIAL-UNITS AEA	→ → 22
-		
QUICK SETUP B (→ 25)	Commissioning and application setups	→ → 25
-		
USER INTERFACE C (→ 35)	CONTROL CAA	→ → 36
	MAIN LINE CCA	→ → 41
	ADDITIONAL LINE CEA	→ → 45
	INFORMATION LINE CGA	→ → 51
-		
TOTALIZERS D (→ 57)	TOTALIZER 1 DAA	→ → 58
	TOTALIZER 2 DAB	→ → 58
	TOTALIZER 3 DAC	→ → 58
	HANDLING TOTALIZER DJA	→ → 61
-		
OUTPUTS E (→ 62)	CURRENT OUTPUT 1 EAA	→ → 63
	CURRENT OUTPUT 2 EAB	→ → 63
	CURRENT OUTPUT 3 EAC	→ → 63
	PULSE/FREQ. OUTPUT 1 ECA	→ → 75
	PULSE/FREQ. OUTPUT 2 ECB	→ → 75
	RELAY OUTPUT 1 EGA	→ → 102
	RELAY OUTPUT 2 EGB	→ → 102
-		
INPUTS F (→ 113)	STATUS INPUT FAA	→ → 114
	CURRENT INPUT FCA	→ → 117
-		
BASIC FUNCTION G (→ 121)	HART GAA	→ → 122
	PROCESS PARAMETER GIA	→ → 125
	SYSTEM PARAMETER GLA	→ → 134
	SENSOR DATA GNA	→ → 136
-		
SPECIAL FUNCTION H (→ 140)	DENSITY FUNCTIONS HAA	→ → 142
	BATCHING FUNCTION HCA	→ → 148
	ADVANCED DIAGNOSIS HEA	→ → 167
-		
SUPERVISION J (→ 178)	SYSTEM JAA	→ → 179
	VERSION-INFO JCA	→ → 183

3 Block MEASURED VARIABLES

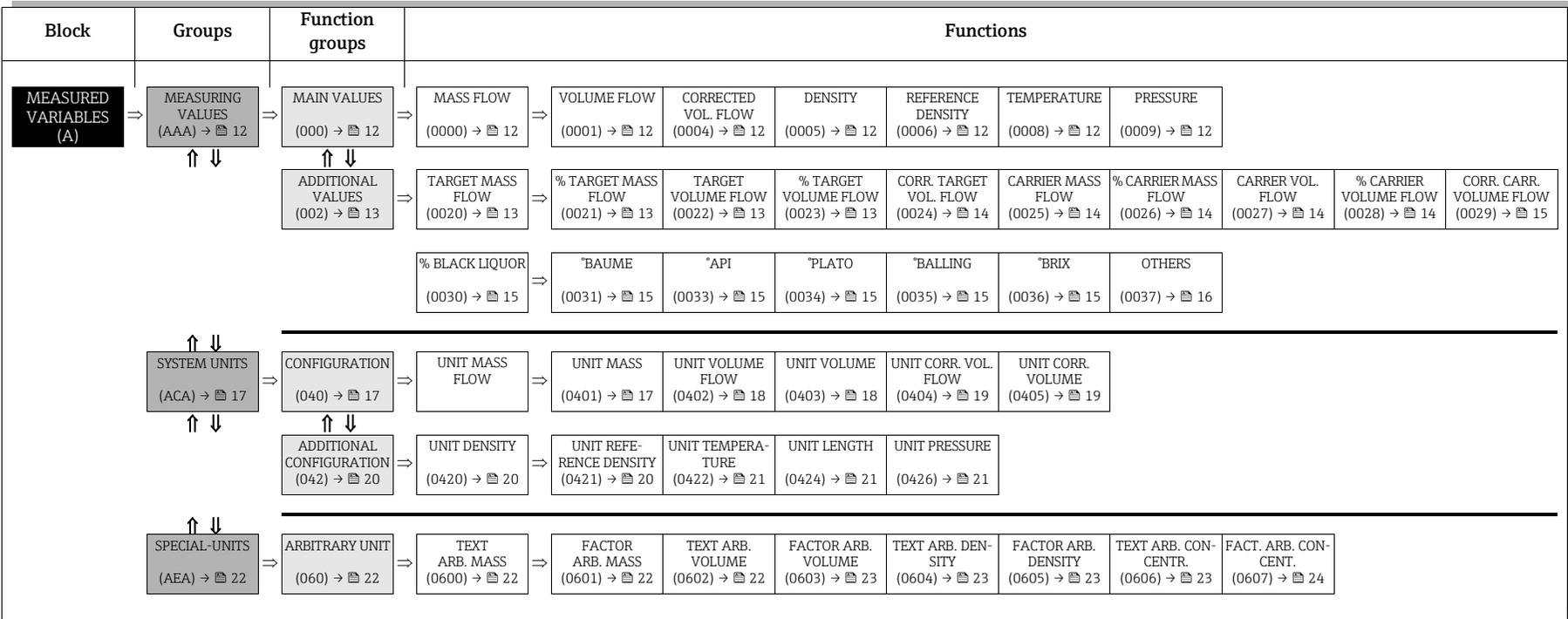

3.1 Group MEASURING VALUES

3.1.1 Function group MAIN VALUES



Function description MEASURED VARIABLES → MEASURING VALUES → MAIN VALUES	
<p> Note!</p> <ul style="list-style-type: none"> ▪ The engineering units of all the measured variables shown here can be set in the “SYSTEM UNITS” group. ▪ If the fluid in the pipe flows backwards, a negative sign prefixes the flow reading on the display. 	
MASS FLOW (0000)	<p>The currently measured mass flow appears on the display.</p> <p>Display: 5-digit floating-point number, including unit and sign (e.g. 462,87 kg/h; -731.63 lb/min; etc.)</p>
VOLUME FLOW (0001)	<p>The calculated volume flow appears on the display. The volume flow is derived from the measured mass flow and the measured density of the fluid.</p> <p>Display: 5-digit floating-point number, including unit and sign (e.g. 5.5445 dm³/min; 1.4359 m³/h; -731.63 gal/d; etc.)</p>
CORRECTED VOLUME FLOW (0004)	<p>The calculated corrected volume flow appears on the display. The calculated corrected volume flow is derived from the measured mass flow and the reference density of the fluid (density at reference temperature, measured or fixed entry).</p> <p>Display: 5-digit floating-point number, including unit and sign (e.g. 1.3549 Nm³/h; 7.9846 scm/day; etc.)</p>
DENSITY (0005)	<p>The currently measured density or its specific gravity appears on the display.</p> <p>Display: 5-digit floating-point number, incl. unit, corresponds to 0.1000 to 6.0000 kg/dm³ (e.g. 1.2345 kg/dm³; 993.5 kg/m³; 1.0015 SG_20 °C; etc.)</p>
REFERENCE DENSITY (0006)	<p>The density of the fluid, at reference temperature, appears on the display. The reference density can be calculated with the measured density or also specified via the function FIXED REF. DENSITY (6461), (see → 129), or read in directly via the current input.</p> <p>Display: 5-digit floating-point number, incl. unit, corresponds to 0.1000 to 6.0000 kg/dm³ (e.g. 1.2345 kg/dm³; 993.5 kg/m³; 1.0015 SG_20 °C; etc.)</p>
TEMPERATURE (0008)	<p>The currently measured temperature appears on the display.</p> <p>Display: max. 4-digit fixed-point number, including unit and sign (e.g. -23.4 °C; 160.0 °F; 295.4 K; etc.)</p>
PRESSURE (0009)	<p>The currently measured pressure appears on the display. This function is not available unless “pressure” was selected in the ASSIGN CURRENT INPUT function (5200).</p> <p>Display: max. 4-digit fixed-point number, including unit and sign (e.g. 50.0 barg; etc.)</p>

3.1.2 Function group ADDITIONAL VALUES

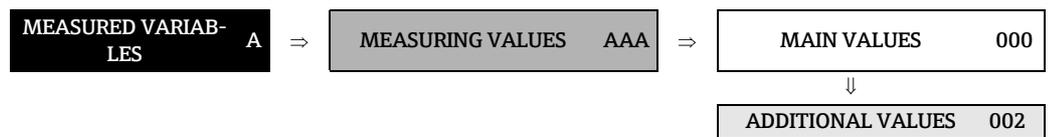

Function description	
MEASURED VARIABLES → MEASURING VALUES → ADDITIONAL VALUES	
TARGET MASS FLOW (0020)	<p> Note! This function is not available unless one of the following was selected:</p> <ul style="list-style-type: none"> ■ in the function DENSITY FUNCTION (7000), see →  142: <ul style="list-style-type: none"> - % MASS / % VOLUME - FLEXIBLE and in the function MODE (7010), see →  145, the selection % MASS 2D or % MASS 3D <p>Use this function to display the currently measured mass flow of the target fluid. Target fluid = carried material (e.g. lime powder).</p> <p>Display: 5-digit floating-point number, including unit and sign</p>
% TARGET MASS FLOW (0021)	<p> Note! This function is not available unless one of the following was selected:</p> <ul style="list-style-type: none"> ■ in the function DENSITY FUNCTION (7000), see →  142: <ul style="list-style-type: none"> - % MASS / % VOLUME - FLEXIBLE and in the function MODE (7010), see →  145, the selection % MASS 2D or % MASS 3D <p>In this function, the currently measured mass flow of the target fluid is displayed as a % (of the overall mass flow). Target fluid = carried material (e.g. lime powder).</p> <p>Display: 5-digit floating-point number, including unit and sign</p>
TARGET VOLUME FLOW (0022)	<p> Note! This function is not available unless one of the following was selected:</p> <ul style="list-style-type: none"> ■ in the function DENSITY FUNCTION (7000), see →  142: <ul style="list-style-type: none"> - % MASS / % VOLUME - FLEXIBLE and in the function MODE (7010), see →  145, the selection % VOLUME 2D or % VOLUME 3D <p>In this function, the currently measured volume flow of the target fluid is displayed. Target fluid = carried material (e.g. lime powder).</p> <p>Display: 5-digit floating-point number, including unit and sign</p>
% TARGET VOLUME FLOW (0023)	<p> Note! This function is not available unless one of the following was selected:</p> <ul style="list-style-type: none"> ■ in the function DENSITY FUNCTION (7000), see →  142: <ul style="list-style-type: none"> - % MASS / % VOLUME - FLEXIBLE and in the function MODE (7010), see →  145, the selection % VOLUME 2D or % VOLUME 3D <p>Use this function to display the currently measured volume flow of the target fluid as a % (of the overall volume flow). Target fluid = carried material (e.g. lime powder).</p> <p>Display: 5-digit floating-point number, including unit and sign</p>

Function description	
MEASURED VARIABLES → MEASURING VALUES → ADDITIONAL VALUES	
CORRECTED TARGET VOLUME FLOW (0024)	<p> Note! This function is not available unless % MASS / % VOLUME was selected in the DENSITY FUNCTION function (7000), (see →  142).</p> <p>Use this function to display the currently measured corrected volume flow of the target fluid. Target fluid = carried material (e.g. lime powder).</p> <p>Display: 5-digit floating-point number, including unit and sign</p>
CARRIER MASS FLOW (0025)	<p> Note! This function is not available unless one of the following was selected:</p> <ul style="list-style-type: none"> ▪ in the function DENSITY FUNCTION (7000), see →  142: <ul style="list-style-type: none"> - % MASS / % VOLUME - FLEXIBLE and in the function MODE (7010), see →  145, the selection % MASS 2D or % MASS 3D <p>Use this function to display the currently measured mass flow of the carrier fluid. Carrier fluid = transporting liquid (e.g. water).</p> <p>Display: 5-digit floating-point number, including unit and sign</p>
% CARRIER MASS FLOW (0026)	<p> Note! This function is not available unless one of the following was selected:</p> <ul style="list-style-type: none"> ▪ in the function DENSITY FUNCTION (7000), see →  142: <ul style="list-style-type: none"> - % MASS / % VOLUME - FLEXIBLE and in the function MODE (7010), see →  145, the selection % MASS 2D or % MASS 3D <p>Use this function to display the currently measured mass flow of the carrier fluid as a % (of the overall mass flow). Carrier fluid = transporting liquid (e.g. water).</p> <p>Display: 5-digit floating-point number, including unit and sign</p>
CARRIER VOLUME FLOW (0027)	<p> Note! This function is not available unless one of the following was selected:</p> <ul style="list-style-type: none"> ▪ in the function DENSITY FUNCTION (7000), see →  142: <ul style="list-style-type: none"> - % MASS / % VOLUME - FLEXIBLE and in the function MODE (7010), see →  145, the selection % VOLUME 2D or % VOLUME 3D <p>Use this function to display the currently measured volume flow of the carrier fluid. Carrier fluid = transporting liquid (e.g. water).</p> <p>Display: 5-digit floating-point number, including unit and sign</p>
% CARRIER VOLUME FLOW (0028)	<p> Note! This function is not available unless one of the following was selected:</p> <ul style="list-style-type: none"> ▪ in the function DENSITY FUNCTION (7000), see →  142: <ul style="list-style-type: none"> - % MASS / % VOLUME - FLEXIBLE and in the function MODE (7010), see →  145, the selection % VOLUME 2D or % VOLUME 3D <p>Use this function to display the currently measured volume flow of the carrier fluid as a % (of the overall mass flow). Carrier fluid = transporting liquid (e.g. water).</p> <p>Display: 5-digit floating-point number, including unit and sign</p>

Function description	
MEASURED VARIABLES → MEASURING VALUES → ADDITIONAL VALUES	
CORRECTED CARRIER VOLUME FLOW (0029)	<p> Note! This function is not available unless % MASS / % VOLUME was selected in the DENSITY FUNCTION function (7000), (see →  142).</p> <p>Use this function to display the currently measured corrected volume flow of the carrier fluid. Carrier fluid = transporting liquid (e.g. water).</p> <p>Display: 5-digit floating-point number, including unit and sign</p>
% BLACK LIQUOR (0030)	<p> Note! This function is not available unless %-BLACK LIQUOR was selected in the DENSITY FUNCTION function (7000), (see →  142).</p> <p>The concentration in %-BLACK LIQUOR is displayed.</p> <p>Display: 5-digit floating-point number, incl. units</p>
°BAUME (0031)	<p> Note! This function is not available unless °BAUME was selected in the DENSITY FUNCTION function (7000), (see →  142).</p> <p>The concentration in °BAUME is displayed.</p> <p>Display: 5-digit floating-point number, incl. units</p>
°API (0033)	<p> Note! This function is not available unless °API was selected in the DENSITY FUNCTION function (7000), (see →  142).</p> <p>The concentration in °API is displayed.</p> <p>Display: 5-digit floating-point number, incl. units</p>
°PLATO (0034)	<p> Note! This function is not available unless °PLATO was selected in the DENSITY FUNCTION function (7000), (see →  142).</p> <p>The concentration in °PLATO is displayed.</p> <p>Display: 5-digit floating-point number, incl. units</p>
°BALLING (0035)	<p> Note! This function is not available unless °BALLING was selected in the DENSITY FUNCTION function (7000), (see →  142).</p> <p>The concentration in °BALLING is displayed.</p> <p>Display: 5-digit floating-point number, incl. units</p>
°BRIX (0036)	<p> Note! This function is not available unless °BRIX was selected in the DENSITY FUNCTION function (7000), (see →  142).</p> <p>The concentration in °BRIX is displayed.</p> <p>Display: 5-digit floating-point number, incl. units</p>

Function description MEASURED VARIABLES → MEASURING VALUES → ADDITIONAL VALUES	
OTHERS (0037)	<p> Note! This function is not available unless FLEXIBLE was selected in the DENSITY FUNCTION function (7000), (see →  142) and this function is not available unless OTHERS 2D or OTHERS 3D was selected in the MODE function (7010), (see →  145).</p> <p>Displays the concentration in the unit, which was defined in the function TEXT ARBITRARY CONCENTRATION (0606), (see →  23).</p> <p>Display: 5-digit floating-point number, incl. units</p>

3.2 Group SYSTEM UNITS

3.2.1 Function group CONFIGURATION

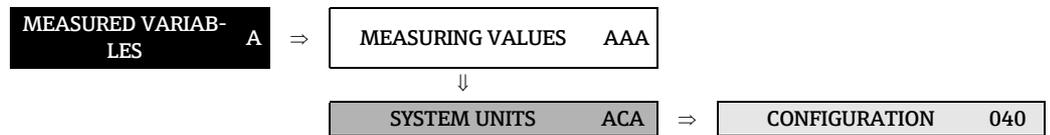

Function description MEASURED VARIABLES → SYSTEM UNITS → CONFIGURATION	
You can select the units for measured variables in this function group.	
UNIT MASS FLOW (0400)	<p>Use this function to select the unit for displaying the mass flow (mass/time).</p> <p>The unit you select here is also valid for:</p> <ul style="list-style-type: none"> ▪ Current outputs ▪ Frequency outputs ▪ Relay switch points (limit value for mass flow, flow direction) ▪ Low flow cut off <p>Options: Metric: gram → g/s; g/min; g/h; g/day kilogram → kg/s; kg/min; kg/h; kg/day ton → t/s; t/min; t/h; t/day</p> <p>US: ounce → oz/s; oz/min; oz/h; oz/day pound → lb/s; lb/min; lb/h; lb/day ton → ton/s; ton/min; ton/h; ton/day</p> <p>For arbitrary units (see function TEXT ARBITRARY MASS on → 22) ____ → ____/s; ____/min; ____/h; ____/day</p> <p>Factory setting: Country-dependent (kg/h or US-lb/min)</p> <p> Note! If you defined a unit of mass in the ARBITRARY UNIT 060 function group (see → 22) the unit in question is shown here.</p>
UNIT MASS (0401)	<p>Use this function to select the unit for displaying the mass.</p> <p>The unit you select here is also valid for:</p> <ul style="list-style-type: none"> ▪ Pulse value (e.g. kg/p) <p>Options: Metric → g; kg; t</p> <p>US → oz; lb; ton</p> <p>For free selectable units → ____ (see function TEXT ARBITRARY MASS on → 22)</p> <p>Factory setting: Country-dependent (kg or US-lb)</p> <p> Note!</p> <ul style="list-style-type: none"> ▪ If you defined a unit of mass in the ARBITRARY UNIT 060 function group (see → 22) the unit in question is shown here. ▪ The unit of the totalizers is independent of your choice here. The unit for each totalizer is selected separately for the totalizer in question.

Function description	
MEASURED VARIABLES → SYSTEM UNITS → CONFIGURATION	
UNIT VOLUME FLOW (0402)	<p>Use this function to select the unit for displaying the volume flow (volume/time).</p> <p>The unit you select here is also valid for:</p> <ul style="list-style-type: none"> ▪ Current outputs ▪ Frequency outputs ▪ Relay switch points (limit value for volume flow, flow direction) ▪ Low flow cut off <p>Options:</p> <p>Metric:</p> <p>Cubic centimeter → cm³/s; cm³/min; cm³/h; cm³/day Cubic decimeter → dm³/s; dm³/min; dm³/h; dm³/day Cubic meter → m³/s; m³/min; m³/h; m³/day Milliliter → ml/s; ml/min; ml/h; ml/day Liter → l/s; l/min; l/h; l/day Hectoliter → hl/s; hl/min; hl/h; hl/day Megaliter → Ml/s; Ml/min; Ml/h; Ml/day</p> <p>US:</p> <p>Cubic centimeter → cc/s; cc/min; cc/h; cc/day Acre foot → af/s; af/min; af/h; af/day Cubic foot → ft³/s; ft³/min; ft³/h; ft³/day Fluid ounce → oz f/s; oz f/min; oz f/h; oz f/day Gallon → gal/s; gal/min; gal/h; gal/day Kilogallon → Kgal/s; Kgal/min; Kgal/h; Kgal/day Million gallon → Mgal/s; Mgal/min; Mgal/h; Mgal/day Barrel (normal fluids: 31.5 gal/bbl) → bbl/s; bbl/min; bbl/h; bbl/day Barrel (beer: 31.0 gal/bbl) → bbl/s; bbl/min; bbl/h; bbl/day Barrel (petrochemicals: 42.0 gal/bbl) → bbl/s; bbl/min; bbl/h; bbl/day Barrel (filling tanks: 55.0 gal/bbl) → bbl/s; bbl/min; bbl/h; bbl/day</p> <p>Imperial</p> <p>Gallon → gal/s; gal/min; gal/h; gal/day Mega gallon → Mgal/s; Mgal/min; Mgal/h; Mgal/day Barrel (beer: 36.0 gal/bbl) → bbl/s; bbl/min; bbl/h; bbl/day Barrel (petrochemicals: 34.97 gal/bbl) → bbl/s; bbl/min; bbl/h; bbl/day</p> <p>For arbitrary units (see function TEXT ARBITRARY VOLUME on → 22) ____ → ____/s; ____/min; ____/h; ____/day</p> <p>Factory setting: Country-dependent (m³/h or US-Mgal/day)</p> <p> Note! If you defined a unit of volume in the ARBITRARY UNIT 060 function group (see → 22) the unit in question is shown here.</p>
UNIT VOLUME (0403)	<p>Use this function to select the unit for displaying the volume. The unit you select here is also valid for: Pulse weighting (e.g. m³/p)</p> <p>Options:</p> <p>Metric → cm³; dm³; m³; ml; l; hl; Ml Mega US → cc; af; ft³; oz f; gal; Kgal; Mgal; bbl (normal fluids); bbl (beer); bbl (petrochemicals) → bbl (filling tanks) Imperial → gal; Mgal; bbl (beer); bbl (petrochemicals) For free selectable units → ____ (see function TEXT ARBITRARY VOLUME on → 22)</p> <p>Factory setting: m³</p> <p> Note!</p> <ul style="list-style-type: none"> ▪ If you defined a unit of volume in the ARBITRARY UNIT 060 function group (see → 22) the unit in question is shown here. ▪ The unit of the totalizers is independent of your choice here. The unit for each totalizer is selected separately for the totalizer in question.

Function description	
MEASURED VARIABLES → SYSTEM UNITS → CONFIGURATION	
UNIT CORRECTED VOLUME FLOW (0404)	<p>Use this function to select the unit for displaying the corrected volume flow (corrected volume/time).</p> <p>The unit you select here is also valid for:</p> <ul style="list-style-type: none"> ▪ Current outputs ▪ Frequency outputs ▪ Relay switch points (limit value for corrected volume flow, flow direction) ▪ Low flow cut off <p>Options: Metric: l/s l/min l/h l/day Nm³/s Nm³/min Nm³/h Nm³/day</p> <p>US: Sm³/s; Sm³/min; Sm³/h; Sm³/day Scf/s; Scf/min; Scf/h; Scf/day</p> <p>Factory setting: Nm³/h</p>
UNIT CORRECTED VOLUME (0405)	<p>Use this function to select the unit for displaying the corrected volume.</p> <p>The unit you select here is also valid for:</p> <ul style="list-style-type: none"> ▪ Pulse value (e.g. Nm³/p) <p>Options: Metric: Nm³ l</p> <p>US: Sm³ Scf</p> <p>Factory setting: Nm³</p> <p> Note! The unit of the totalizers is independent of your choice here. The unit for each totalizer is selected separately for the totalizer in question.</p>

3.2.2 Function group ADDITIONAL CONFIGURATION

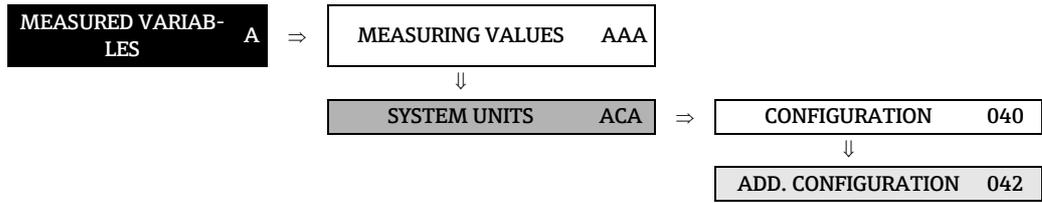

Function description	
MEASURED VARIABLES → SYSTEM UNITS → ADDITIONAL CONFIGURATION	
UNIT DENSITY (0420)	<p>Use this function to select the unit for displaying the fluid density.</p> <p>The unit you select here is also valid for:</p> <ul style="list-style-type: none"> ▪ Current outputs ▪ Frequency outputs ▪ Relay switch points (limit value for density) ▪ Density response value for EPD ▪ Density adjustment value <p>Options: Metric → g/cm³; g/cc; kg/dm³; kg/l; kg/m³; SD 4 °C, SD 15 °C, SD 20 °C; SG 4 °C, SG 15 °C, SG 20 °C</p> <p>US → lb/ft³; lb/gal; lb/bbl (normal fluids); lb/bbl (beer); lb/bbl (petrochemicals); lb/bbl (filling tanks)</p> <p>Imperial → lb/gal; lb/bbl (beer); lb/bbl (petrochemicals)</p> <p>Factory setting: kg/l</p> <p>SD = Specific Density, SG = Specific Gravity The specific density is the ratio of fluid density to water density (at water temperature = 4, 15, 20 °C).</p>
UNIT REFERENCE DENSITY (0421)	<p>Use this function to select the unit for displaying the reference density.</p> <p>The unit you select here is also valid for:</p> <ul style="list-style-type: none"> ▪ Current outputs ▪ Frequency outputs ▪ Relay switch points (limit value for density) ▪ Fixed reference density (for calculation of corrected volume flow) ▪ Current input (read in the reference density via current input) <p>Options: Metric: kg/Nm³ kg/Nl</p> <p>US: g/Scf kg/Sm³ lb/Scf</p> <p>Factory setting: kg/Nl</p>

Function description	
MEASURED VARIABLES → SYSTEM UNITS → ADDITIONAL CONFIGURATION	
UNIT TEMPERATURE (0422)	<p>Use this function to select the unit for displaying the temperature.</p> <p>The unit you select here is also valid for:</p> <ul style="list-style-type: none"> ▪ Current outputs ▪ Frequency outputs ▪ Current input ▪ Relay switch points (limit value for temperature) ▪ Reference temperature (for corrected volume measurement with measured reference density) <p>Options: °C (Celsius) K (Kelvin) °F (Fahrenheit) °R (Rankine)</p> <p>Factory setting: °C</p>
UNIT LENGTH (0424)	<p>Use this function to select the unit for displaying the length of the nominal diameter.</p> <p>The unit you select here is valid for:</p> <ul style="list-style-type: none"> ▪ Nominal diameter of sensor (function NOMINAL DIAMETER (6804) on →  136) <p>Options: MILLIMETER INCH</p> <p>Factory setting: MILLIMETER</p>
UNIT PRESSURE (0426)	<p>Use this function to select the unit for pressure.</p> <p>The unit you select here is valid for:</p> <ul style="list-style-type: none"> ▪ Specified pressure (see function PRESSURE (6501) on →  133) <p>Options: bar a bar g psi a psi g</p> <p>Factory setting: bar g</p>

3.3 Group SPECIAL-UNITS

3.3.1 Function group ARBITRARY UNIT

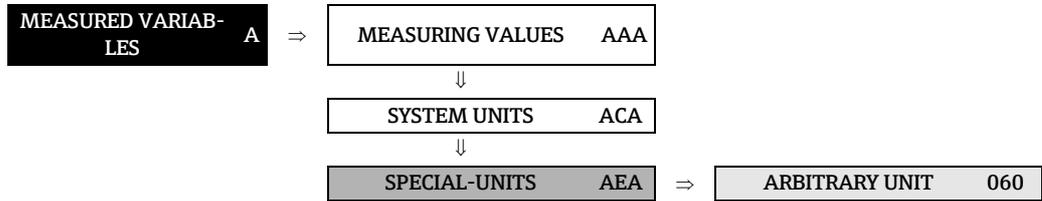

Function description	
MEASURED VARIABLES → SPECIAL-UNITS → ARBITRARY UNIT	
Use this function group to define a free selectable unit for mass, mass flow, volume, volume flow, density and concentration (optional).	
TEXT ARBITRARY MASS (0600)	Use this function to enter a text for the selectable mass unit / mass flow unit. You define only the text, the unit of time is provided from a choice of options (s, min, h, day). User input: xxxxxxx (max. 4 characters) Valid characters are A-Z, 0-9, +, -, decimal point, white space or underscore Factory setting: “ _ _ _ _ ” (No text) Example: If your text entry is “CENT” (for centner), this text string appears on the display complete with the unit of time, e.g. “CENT/min”: CENT = Mass (text input) CENT / min = Mass flow as shown (on the display)
FACTOR ARBITRARY MASS (0601)	Use this function to define a quantity factor (without time) for the selectable mass- / mass flow unit. The mass unit on which this factor is based is one kilogram. User input: 7-digit floating-point number Factory setting: 1 Reference quantity: kg Example: One centner is equivalent to 50 kg → 0.02 centner = 1 kg User input: 0.02
TEXT ARBITRARY VOLUME (0602)	Use this function to enter a text for the selectable volume unit / volume flow unit. You define only the text, the unit of time is provided from a choice of options (s, min, h, day). User input: xxxxxxx (max. 4 characters) Valid characters are A-Z, 0-9, +, -, decimal point, white space or underscore Factory setting: “ _ _ _ _ ” (No text) Example: If your text entry is “GLAS”, this text string appears on the display complete with the unit of time, e.g. “GLAS/min”: GLAS = Volume (text input) GLAS / min = Volume flow as shown (on the display)

Function description	
MEASURED VARIABLES → SPECIAL-UNITS → ARBITRARY UNIT	
FACTOR ARBITRARY VOLUME (0603)	<p>Use this function to define a quantity factor (without time) for the selectable unit. The volume unit on which this factor is based is one liter.</p> <p>User input: 7-digit floating-point number</p> <p>Factory setting: 1</p> <p>Reference quantity: Liter</p> <p>Example: The volume of a glass is 0.5 l → 2 glasses = 1 liter User input: 2</p>
TEXT ARBITRARY DENSITY (0604)	<p>Use this function to enter a text for the selectable density unit.</p> <p>User input: xxxxxxx (max. 4 characters) Valid characters are A-Z, 0-9, +, -, decimal point, white space or underscore</p> <p>Factory setting: “ _ _ _ _ ” (No text)</p> <p>Example: Enter text “CE_L” (for centner per liter).</p>
FACTOR ARBITRARY DENSITY (0605)	<p>Use this function to define a quantity factor for the selectable density unit. The density unit on which this factor is based is one kg/l.</p> <p>User input: 7-digit floating-point number</p> <p>Factory setting: 1</p> <p>Reference quantity: kg/l</p> <p>Example: One centner per liter is equivalent to 50 kg/l → 0.02 centner/l = 1 kg/l User input: 0.02</p>
TEXT ARBITRARY CONCENTRATION (0606)	<p> Note! This function is not available unless the optional software package CONCENTRATION is installed.</p> <p>Use this function to enter a text for the selectable concentration unit (user-defined density unit).</p> <p>User input: xxxxxxx (max. 4 characters) Valid characters are A-Z, 0-9, +, -, decimal point, white space or underscore</p> <p>Factory setting: “ _ _ _ _ ” (No text)</p> <p>Example: Enter text “HFCS” (for High Fructose Corn Syrup).</p>

Function description	
MEASURED VARIABLES → SPECIAL-UNITS → ARBITRARY UNIT	
FACTOR ARBITRARY CONCENTRATION (0607)	<p> Note! This function is not available unless the optional software package CONCENTRATION is installed and an option selected in the function DENSITY FUNCTION (7000), (see →  142).</p> <p>Use this function to define a factor for the selectable concentration unit, see function TEXT ARBITRARY CONCENTRATION (0606).</p> <p>User input: 7-digit floating-point number</p> <p>Factory setting: 1</p> <p>Reference quantity: Arbitrary concentration unit / %</p> <p>Example: The measured concentration 1% should be output as 0.01 HFCS value User input → 0.01 [HFCS]</p>

4 Block QUICK SETUP

Block	Group	Function groups	Functions										
QUICK SETUP (B)	⇒	⇒	<table border="1"> <tr> <td>QUICK SETUP COMMISSIONING (1002) → 25</td> <td>⇒</td> <td>QUICK SETUP PULS.FLOW (1003) → 25</td> <td>QUICK SETUP GAS MEASUR. (1004) → 25</td> <td>QUICK SETUP BATCH/DOSING (1005) → 26</td> </tr> <tr> <td colspan="5" style="text-align: center;">T-DAT SAVE/LOAD (1009) → 26</td> </tr> </table>	QUICK SETUP COMMISSIONING (1002) → 25	⇒	QUICK SETUP PULS.FLOW (1003) → 25	QUICK SETUP GAS MEASUR. (1004) → 25	QUICK SETUP BATCH/DOSING (1005) → 26	T-DAT SAVE/LOAD (1009) → 26				
QUICK SETUP COMMISSIONING (1002) → 25	⇒	QUICK SETUP PULS.FLOW (1003) → 25	QUICK SETUP GAS MEASUR. (1004) → 25	QUICK SETUP BATCH/DOSING (1005) → 26									
T-DAT SAVE/LOAD (1009) → 26													

Function description QUICK SETUP	
QUICK SETUP COMMISSIONING (1002)	<p>Use this function to start the Setup menu for commissioning.</p> <p>Options: YES NO</p> <p>Factory setting: NO</p> <p> Note! You will find a flowchart of the COMMISSIONING setup menu on → 27. For more information on Setup menus, please refer to the Operating Instructions <i>Proline Promass 83</i>, BA 059D/06/en.</p>
QUICK SETUP PULSATING FLOW (1003)	<p>Use this function to start the application-specific Setup menu for pulsating flow.</p> <p>Options: YES NO</p> <p>Factory setting: NO</p> <p> Note! You will find a flowchart of the PULSATING FLOW setup menu on → 29. For more information on Setup menus, please refer to the Operating Instructions <i>Proline Promass 83</i>, BA 059D/06/en.</p>
QUICK SETUP GAS MEASUR. (1004)	<p>Use this function to start the application specific Setup menu for the gas measurement.</p> <p>Options: YES NO</p> <p>Factory setting: NO</p> <p> Note! You will find a flowchart of the GAS MEASUREMENT setup menu on → 31. For more information on Setup menus, please refer to the Operating Instructions <i>Proline Promass 83</i>, BA 059D/06/en.</p>

Function description QUICK SETUP	
QUICK SETUP BATCHING/DOSING (1005)	<p> Note! This function is only available when the optional software package BATCHING is installed.</p> <p>Use this function to start the (optional) application specific Setup menu for batching.</p> <p>Options: YES NO</p> <p>Factory setting: NO</p> <p> Note! You will find a flowchart of the BATCHING setup menu on →  32. For more information on Setup menus, please refer to the Operating Instructions <i>Proline Promass 83, BA 059D/06/en</i>.</p>
T-DAT SAVE/LOAD (1009)	<p>Use this function to save the parameter settings / configuration of the transmitter in a transmitter DAT (T-DAT), or to load the parameter settings from the T-DAT into the EEPROM (manual safety function).</p> <p>Application examples:</p> <ul style="list-style-type: none"> ▪ After commissioning, the current measuring point parameters can be saved to the T-DAT as a backup. ▪ If the transmitter is replaced for some reason, the data from the T-DAT can be loaded into the new transmitter (EEPROM). <p>Options: CANCEL SAVE (from EEPROM to T-DAT) LOAD (from the T-DAT into EEPROM)</p> <p>Factory setting: CANCEL</p> <p> Note!</p> <ul style="list-style-type: none"> ▪ If the target device has an older software version, the message “TRANSM. SW-DAT” is displayed during startup. Then only the “SAVE” function is available. ▪ LOAD This function is only possible if the target device has the same software version as, or a more recent software version than, the source device. ▪ SAVE This function is always available.

4.1 Setup Commissioning

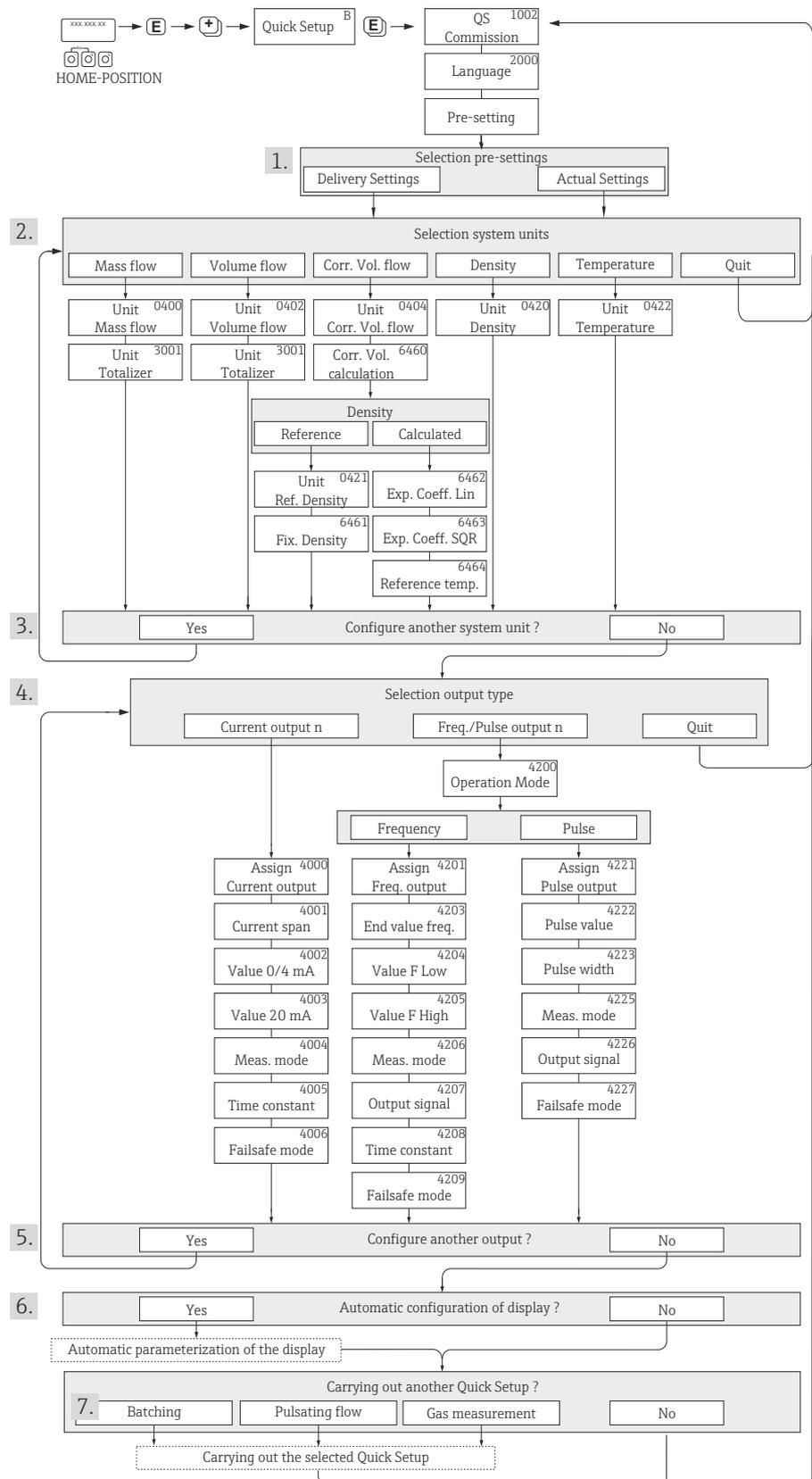

- ① Selecting “DELIVERY SETTINGS” returns each selected unit to the factory setting. Selecting “ACTUAL SETTING” applies the units you have set previously.
- ② Only units not yet configured in the current Setup are offered for selection in each cycle. The unit for mass, volume and corrected volume is derived from the corresponding flow unit.
- ③ The “YES” option remains visible until all the units have been configured. “NO” is the only option displayed when no further units are available.
- ④ Only the outputs not yet configured in the current Setup are offered for selection in each cycle.
- ⑤ The “YES” option remains visible until all the outputs have been configured. “NO” is the only option displayed when no further outputs are available.
- ⑥ The “automatic parameterization of the display” option contains the following basic settings/factory settings:
 - YES: Main line = Mass flow; Additional line = Totalizer 1; Information line = Operating/system conditions
 - No: The existing (selected) settings remain.
- ⑦ The QUICK SETUP BATCHING is only available when the optional software package BATCHING is installed.

Note!

- The display returns to the cell QUICK SETUP COMMISSIONING (1002) if you press the  key combination during parameter interrogation. The stored parameters remain valid.
- The “Commissioning” Quick Setup must be carried out before one of the Quick Setups explained below is run.

4.2 Pulsating flow Setup menu

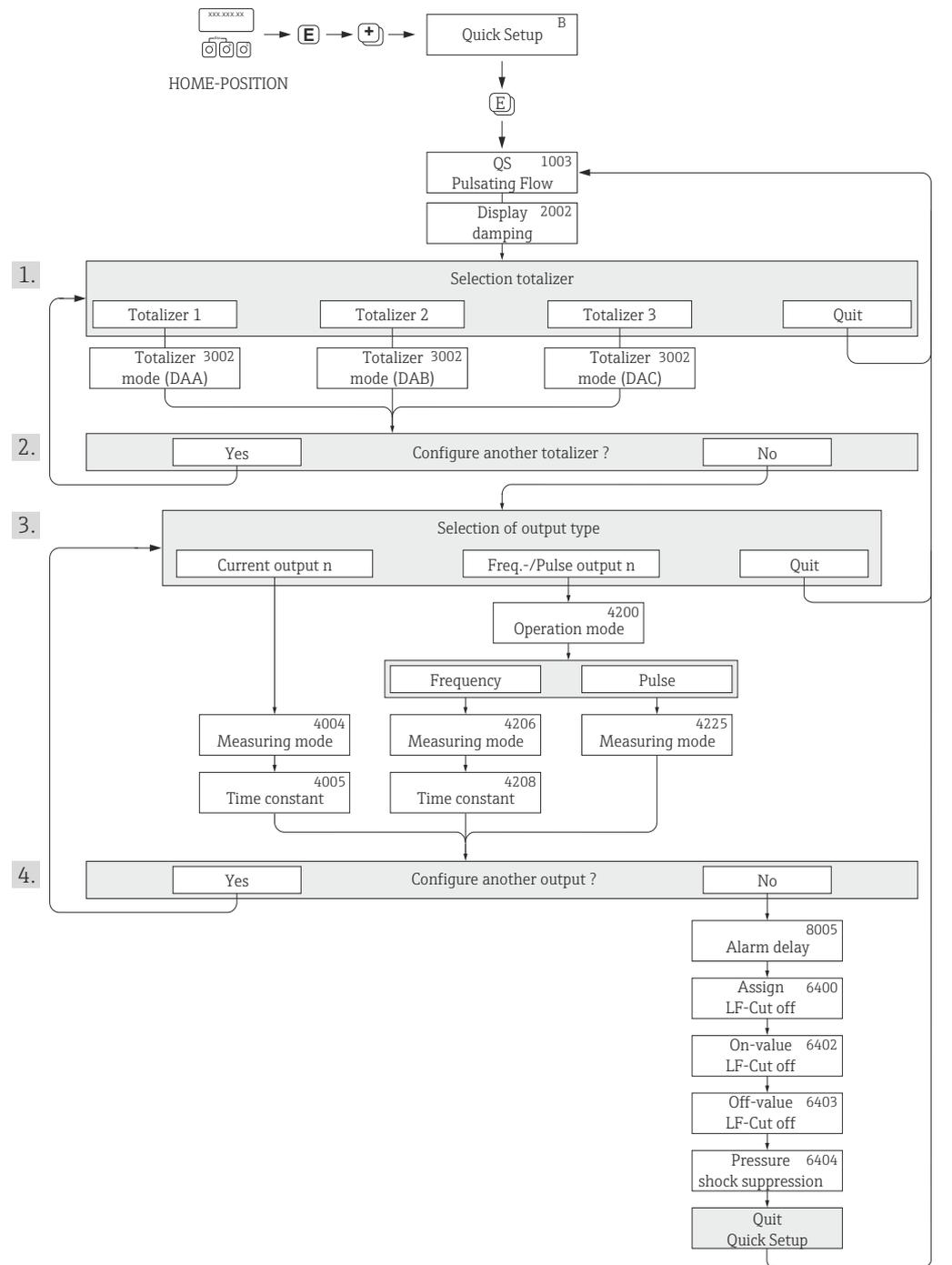

A0002615-en

- ① Only totalizers not yet configured in the current Setup are offered for selection in each cycle.
- ② The “YES” option remains visible until all the totalizers have been configured. “NO” is the only option displayed when no further totalizers are available.
- ③ Only the outputs not yet configured in the current Quick Setup are offered for selection in each cycle.
- ④ The “YES” option remains visible until all the outputs have been configured. “NO” is the only option displayed when no further outputs are available.



Note!

- The display returns to the cell QUICK SETUP PULSATING FLOW (1003) if you press the key combination during parameter interrogation.
- You can call up this Setup menu either directly from the “COMMISSIONING” Setup menu or manually by means of the function QUICK SETUP PULSATING FLOW (1003).

Settings for the Pulsating Flow Setup menu:			
Fct. code	Function name	Suggested settings	Description
Call up through the function matrix:			
B	QUICK SETUP	QUICK SETUP PULSATING FLOW	→ 25
1003	QUICK SETUP PULS.FLOW	YES	→ 25
Basic configuration:			
2002	DISPLAY DAMPING	1 second	→ 37
3002	TOTALIZER MODE (DAA)	BALANCE	→ 59
3002	TOTALIZER MODE (DAB)	BALANCE	→ 59
3002	TOTALIZER MODE (DAC)	BALANCE	→ 59
Select the signal type: CURRENT OUTPUT (1...n)			
4004	MEASURING MODE	PULSATING FLOW	→ 69
4005	TIME CONSTANT	1 second	→ 71
Select the signal type: FREQ./PULSE OUTPUT (1...2) / operating mode: FREQUENCY			
4206	MEASURING MODE	PULSATING FLOW	→ 80
4208	TIME CONSTANT	0 seconds	→ 85
Select the signal type: FREQ./PULSE OUTPUT (1...2) / operating mode: PULSE			
4225	MEASURING MODE	PULSATING FLOW	→ 88
Other settings:			
8005	ALARM DELAY	0 seconds	→ 180
6400	ASSIGN LF CUT OFF	MASS FLOW	→ 125
6402	ON-VALUE LOW FLOW CUT OFF	Depends on diameter (DN [mm]): - DN 1 = 0.02 [kg/h] or [l/h] - DN 2 = 0.10 [kg/h] or [l/h] - DN 4 = 0.45 [kg/h] or [l/h] - DN 8 = 2.0 [kg/h] or [l/h] - DN 15 = 6.5 [kg/h] or [l/h] - DN 15* = 18 [kg/h] or [l/h] - DN 25 = 18 [kg/h] or [l/h] - DN 25* = 45 [kg/h] or [l/h] - DN 40 = 45 [kg/h] or [l/h] - DN 40* = 70 [kg/h] or [l/h] - DN 50 = 70 [kg/h] or [l/h] - DN 50* = 180 [kg/h] or [l/h] - DN 80 = 180 [kg/h] or [l/h] - DN 100 = 350 [kg/h] or [l/h] - DN 150 = 650 [kg/h] or [l/h] - DN 250 = 1800 [kg/h] or [l/h] *DN 15, 25, 40 “FB” = Full bore versions Promass I	→ 125
6403	OFF-VALUE LOW FLOW CUT OFF	50%	→ 125
6404	PRESSURE SHOCK SUPPRESSION	0 s	→ 126

4.3 Gas measurement Setup menu

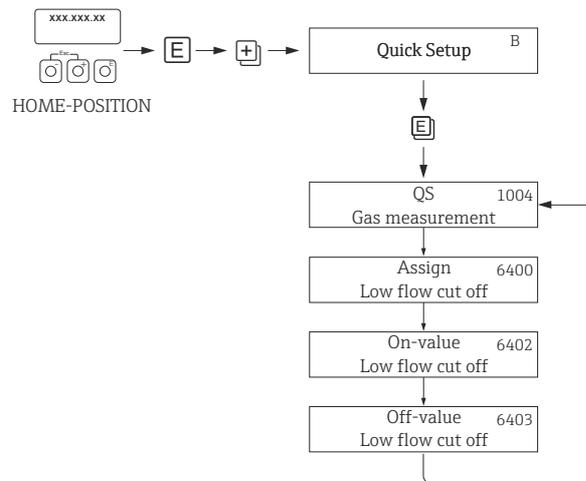

A0002502-en

Settings for the Gas Measurement Setup menu:

Fct. code	Function name	Suggested settings	Description
Call up through the function matrix:			
B	QUICK SETUP	QUICK SETUP GAS MEASUR.	→ 25
1004	QUICK SETUP GAS MEASUR.	YES	→ 25
Basic configuration:			
6420	EMPTY PIPE DETECTION	No entry possible, the selection changes automatically to OFF.	→ 127
6400	ASSIGN LOW FLOW CUT OFF	For gas measurement we recommend to switch off the low flow cut off. OFF	→ 125
6402	ON-VALUE LOW FLOW CUT OFF	If you don't switch off the low flow cut off: 0.0000	→ 125
6403	OFF-VALUE LOW FLOW CUT OFF	If you don't switch off the low flow cut off: 50%	→ 125

4.4 Batching Setup menu

This Setup menu guides the user systematically through all the device functions that have to be adjusted and configured for batching operation.

The Setup menu settings result in a (simple) one-stage batching process. The parameters for additional settings, e.g. for automatic compensation of after-runs or multistage batching must be manually set in the function matrix.

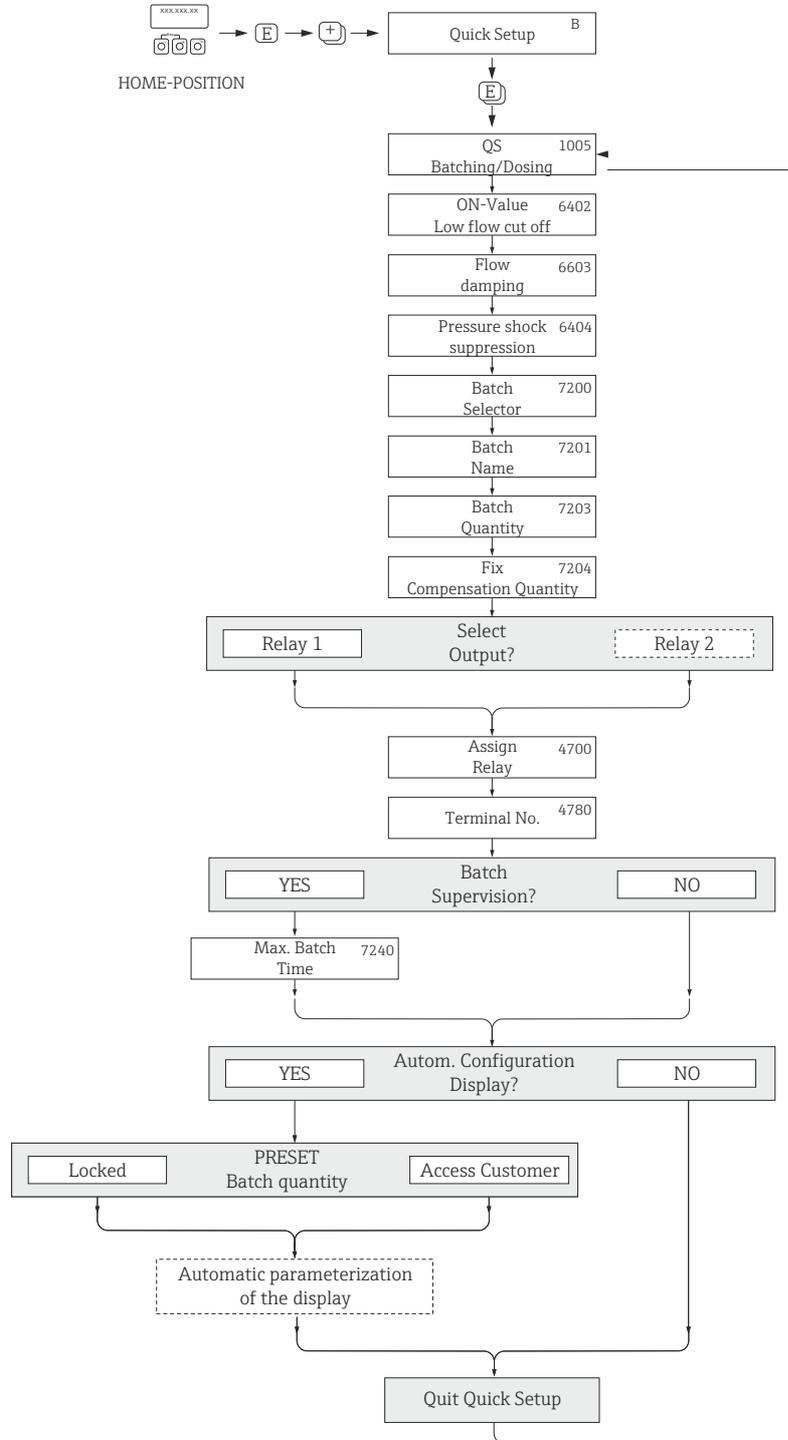

A0004644-en

**Note!**

- This Setup menu is only available when the optional software package BATCHING is installed in the measuring device. By means of the order option, the software package can already be installed in the measuring device when delivered from the factory or it can be ordered at a later date from Endress + Hauser and installed as an optional software package.
- The display returns to the function QUICK SETUP BATCHING/DOSING (1005), if you press the ESC key combination during parameter interrogation.
- At the start of the Setup, general device parameters are optimally configured for measuring signal processing and output response.
- Then you can enter the specific batching parameters, starting with the options list “Batching 1..6”. In this way, by running through the Setup menu a number of times, up to six different batching parameter sets (incl. special naming) can be created and called up as necessary.
- In order to enjoy full functionality, it is advisable to let the display parameters be set automatically. This means that the lowest display line is configured as the batching menu. Soft-keys are displayed which can be used to start or stop the batching process in the HOME position. In this way, the measuring device can be fully deployed as a “batch controller”.

**Caution!**

By running the Setup, certain device parameters are optimally set for discontinuous operation. Should the measuring device be used for continuous flow measurement at a later time, we recommend you to rerun the “COMMISSIONING” or the “PULSATING FLOW” Setup.

Settings for the Batching Setup menu:

Fct. code	Function name	Suggested settings	Description
Call up through the function matrix:			
B	QUICK SETUP	QUICK SETUP BATCHING/DOSING	→ 25
1005	QUICK SETUP BATCHING/DOSING	YES	→ 26
Settings (functions with a gray background are set automatically):			
6400	ASSIGN LOW FLOW CUT OFF	Mass	→ 125
6402	ON-VALUE LOW FLOW CUT OFF	Table value	→ 125
6403	OFF-VALUE LOW FLOW CUT OFF	50%	→ 125
6603	FLOW DAMPING	0 seconds	→ 134
6404	PRESSURE SHOCK SUPPRESSION	0 seconds	→ 126
7200	BATCH SELECTOR	BATCH #1	→ 148
7202	BATCH NAME	BATCH #1	→ 148
7201	ASSIGN BATCH VARIABLE	Mass	→ 149
7203	BATCH QUANTITY	0	→ 149
7204	FIX COMPENSATION QUANTITY	0	→ 149
7205	COMPENSATION MODE	OFF	→ 150
7208	BATCH STAGES	1	→ 153
7209	INPUT FORMAT	Value input	→ 153
4700	ASSIGN RELAY	BATCHING VALVE 1	→ 102
4780	TERMINAL NUMBER	Output (display only)	→ 109
7220	OPEN VALVE 1	0% or 0 [unit]	→ 154
7240	MAXIMUM BATCHING TIME	0 seconds (Off)	→ 159
7241	MIN. BATCHING QUANTITY	0 seconds	→ 160
7242	MAX. BATCHING QUANTITY	0 seconds	→ 161
2200	ASSIGN (Main line)	BATCH NAME	→ 41

2220	ASSIGN (Multiplex main line)	Off	→ 43
2400	ASSIGN (Additional line)	BATCH DOWNWARDS	→ 45
2420	ASSIGN (Multiplex additional line)	Off	→ 48
2600	ASSIGN (Info line)	BATCHING KEYS	→ 51
2620	ASSIGN (Multiplex info line)	Off	→ 54

4.5 Data back-up/transfer

You can use the T-DAT SAVE/LOAD function to transfer data (device parameters and settings) between the T-DAT (removable memory) and the EEPROM (device memory).

This is required for the following applications:

- Creating a backup: current data are transmitted from an EEPROM to the T-DAT.
- Replacing a transmitter: current data are copied from an EEPROM to the T-DAT, then transmitted to the EEPROM of the new transmitter.
- Duplicating data: current data are copied from an EEPROM to the T-DAT, then transmitted to EEPROMs of identical measuring points.

Note!

Installing and removing the T-DAT → Operating Instructions of the Promass 83 (BA059D)

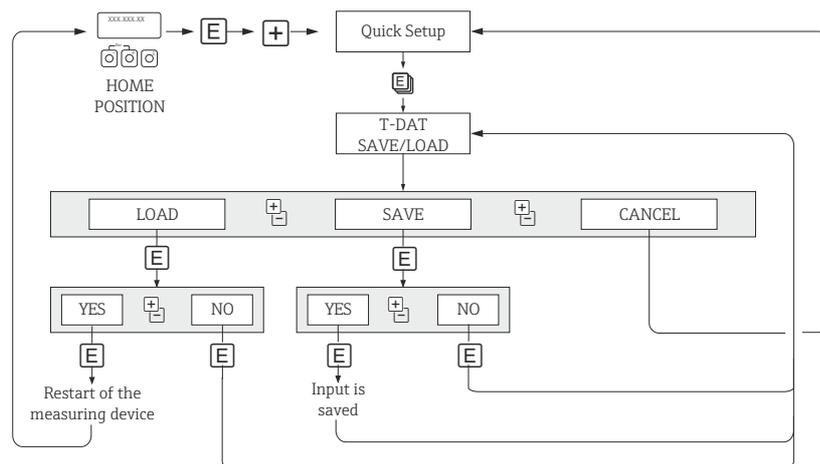

a0001221-en

Data storage/transmission with T-DAT SAVE/LOAD

Notes on the LOAD and SAVE options:

LOAD:

Data are transmitted from the T-DAT to the EEPROM.

Note!

- Previously saved settings on the EEPROM are deleted.
- This selection is available only if the T-DAT contains valid data.
- This selection can be made only if the software version of the T-DAT is the same or newer than that of the EEPROM. Otherwise, the error message "TRANSM. SW-DAT" appears after the restart and the LOAD function is subsequently no longer available.

SAVE:

Data are transmitted from the EEPROM to the T-DAT.

5 Block USER INTERFACE

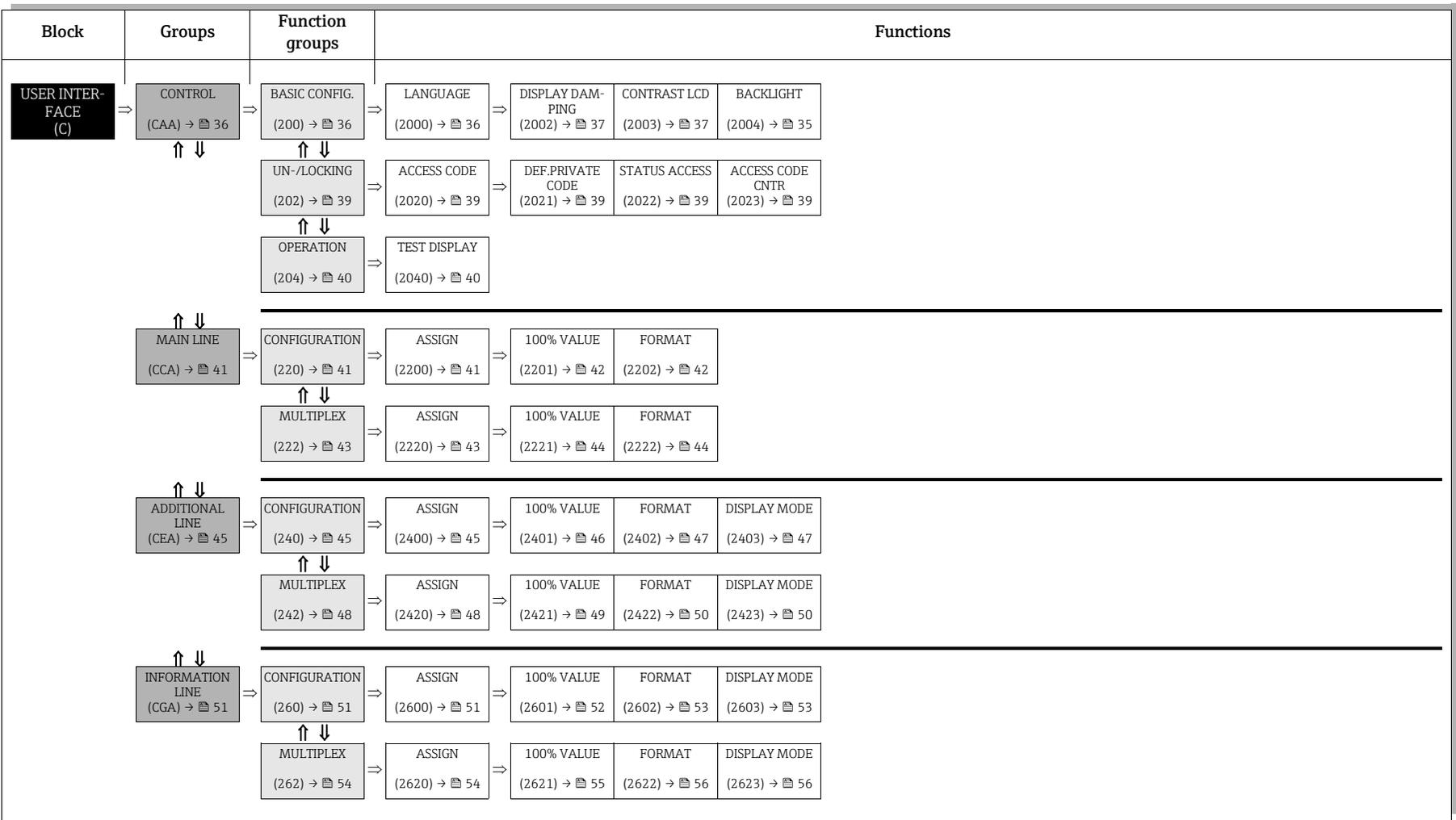

5.1 Group CONTROL

5.1.1 Function group BASIC CONFIGURATION

USER INTERFACE C	⇒	CONTROL CAA	⇒	BASIC CONFIGURATION 200
Function description				
USER INTERFACE → CONTROL → BASIC CONFIGURATION				
LANGUAGE (2000) (HART 5)	<p>Use this function to select the language for all texts, parameters and messages shown on the local display.</p> <p> Note! The displayed options depend on the available language group shown in the LANGUAGE GROUP (8226) function.</p> <p>Options:</p> <p>Language group WEST EU / USA: ENGLISH DEUTSCH FRANCAIS ESPANOL ITALIANO NEDERLANDS PORTUGUESE</p> <p>Language group EAST EU / SCAND: ENGLISH NORSK SVENSKA SUOMI POLISH RUSSIAN CZECH</p> <p>Language group ASIA: ENGLISH BAHASA INDONESIA JAPANESE (syllabary)</p> <p>Language group CHINA: ENGLISH CHINESE</p> <p>Factory setting: Country-dependent (→  188)</p> <p> Note!</p> <ul style="list-style-type: none"> ▪ If you press the  keys at startup, the language defaults to “ENGLISH”. ▪ You can change the language group via the configuration software FieldCare. Please do not hesitate to contact your E+H sales office if you have any questions. 			

Function description	
USER INTERFACE → CONTROL → BASIC CONFIGURATION	
LANGUAGE (2000) (HART 7)	<p>Use this function to select the language for all texts, parameters and messages shown on the local display.</p> <p> Note! The displayed options depend on the available language group shown in the LANGUAGE GROUP (8226) function.</p> <p>Options: Option P, Q: ENGLISH DEUTSCH FRANCAIS ESPANOL ITALIANO NEDERLANDS</p> <p>Option R, S: ENGLISH NEDERLANDS PORTUGUESE RUSSIAN CZECH</p> <p>Option T, U: ENGLISH BAHASA INDONESIA POLISH CHINA</p> <p>Option 4, 5: ENGLISH NORSK SVENSKA SUOMI JAPANESE</p> <p>Factory setting: Country-dependent (→  188)</p> <p> Note!</p> <ul style="list-style-type: none"> ▪ If you press the  /  keys at startup, the language defaults to "ENGLISH". ▪ You can change the language group via the configuration program FieldCare. Please do not hesitate to contact your Endress+Hauser sales office if you have any questions.
DISPLAY DAMPING (2002)	<p>Use this function to enter a time constant defining how the display reacts to severely fluctuating flow variables, either very quickly (enter a low time constant) or with damping (enter a high time constant).</p> <p>User input: 0...100 seconds</p> <p>Factory setting: 1 s</p> <p> Note! Setting the time constant to zero seconds switches off damping.</p>
CONTRAST LCD (2003)	<p>Use this function to optimize display contrast to suit local operating conditions.</p> <p>User input: 10...100%</p> <p>Factory setting: 50%</p>

Function description USER INTERFACE → CONTROL → BASIC CONFIGURATION	
BACKLIGHT (2004)	<p>Use this function to optimize the backlight to suit local operating conditions.</p> <p>User input: 0...100%</p> <p> Note! Entering the value "0" means that the backlight is "switched off". The display then no longer emits any light, i.e. the display texts can no longer be read in the dark.</p> <p>Factory setting: 50%</p>

5.1.2 Function group UNLOCKING/ LOCKING

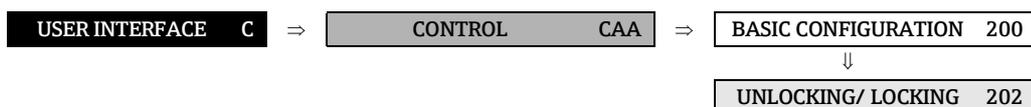

Function description	
USER INTERFACE → CONTROL → UNLOCKING/ LOCKING	
ACCESS CODE (2020)	<p>All data of the measuring system are protected against inadvertent change. Programming is disabled and the settings cannot be changed until a code is entered in this function. If you press the / keys in any function, the measuring system automatically goes to this function and the prompt to enter the code appears on the display (when programming is disabled).</p> <p>You can enable programming by entering your personal code (Factory setting = 83, see function DEFINE PRIVATE CODE (2021)).</p> <p>User input: max. 4-digit number: 0 ...9999</p> <p> Note!</p> <ul style="list-style-type: none"> ▪ Programming is disabled if you do not press a key within 60 seconds following automatic return to the HOME position. ▪ You can also disable programming in this function by entering any number (other than the defined private code). ▪ The Endress+Hauser service organization can be of assistance if you mislay your personal code.
DEFINE PRIVATE CODE (2021)	<p>Use this function to specify a personal code for enabling programming in the function ACCESS CODE.</p> <p>User input: 0...9999 (max. 4-digit number)</p> <p>Factory setting: 83</p> <p> Note!</p> <ul style="list-style-type: none"> ▪ Programming is always enabled with the code "0". ▪ Programming has to be enabled before this code can be changed. When programming is disabled this function is not available, thus preventing others from accessing your personal code.
STATUS ACCESS (2022)	<p>Use this function to check the access status for the function matrix.</p> <p>Display: ACCESS CUSTOMER (parameterization possible) LOCKED (parameterization disabled)</p>
ACCESS CODE COUNTER (2023)	<p>Displays how often the customer code, service code or the digit "0" (code-free) has been entered to gain access to the function matrix.</p> <p>Display: max. 7-digit number: 0...9999999</p> <p>Factory setting: 0</p>

5.1.3 Function group OPERATION

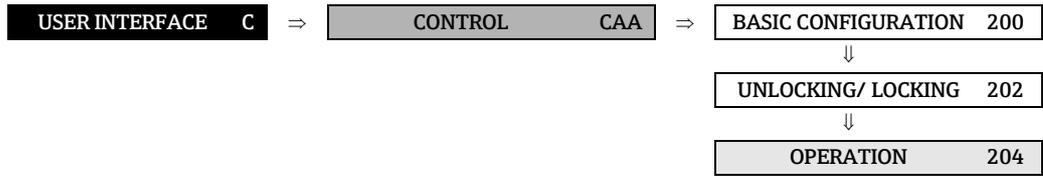

Function description	
USER INTERFACE → CONTROL → OPERATION	
TEST DISPLAY (2040)	<p>Use this function to test the operability of the local display and its pixels.</p> <p>Options: OFF ON</p> <p>Factory setting: OFF</p> <p>Test sequence:</p> <ol style="list-style-type: none"> 1. Start the test by selecting ON. 2. All pixels of the main line, additional line and information line are darkened for minimum 0.75 second. 3. Main line, additional line and information line show an “8” in each field for minimum 0.75 seconds. 4. Main line, additional line and information line show a “0” in each field for minimum 0.75 seconds. 5. Main line, additional line and information line show nothing (blank display) for minimum 0.75 second. <p>When the test is completed, the local display returns to its initial state and the setting changes to OFF.</p>

5.2 Group MAIN LINE

5.2.1 Function group CONFIGURATION

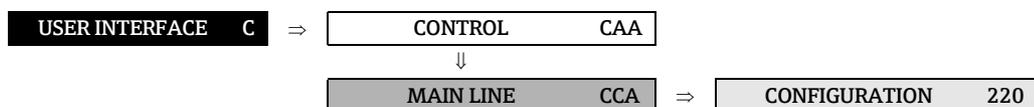

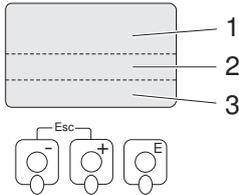
Function description	
USER INTERFACE → MAIN LINE → CONFIGURATION	
	
A0001253	
1 = main line, 2 = additional line, 3 = information line	
ASSIGN (2200)	<p>In this function, a value to be displayed is assigned to the main line (top line in the local display). This value is displayed during normal operation.</p> <p>Options (standard): OFF MASS FLOW MASS FLOW IN % VOLUME FLOW VOLUME FLOW IN % CORRECTED VOLUME FLOW CORRECTED VOLUME FLOW IN % DENSITY REFERENCE DENSITY TEMPERATURE ACTUAL CURRENT (1...3) ACTUAL FREQUENCY (1...2) TOTALIZER (1...3) ACTUAL CURRENT INPUT</p> <p>Factory setting: MASS FLOW</p> <p>Advanced options with optional software package BATCHING: BATCH NAME ("BATCH # 1" or "BEER 330", etc.) BATCH QUANTITY (overall quantity to be batched) BATCH COUNTER (batching processes carried out) BATCH SUM (effective total batching quantity)</p> <p> Note! The options given in the BATCHING software package always refer to the batching selected ("BATCH # 1", "BATCH # 2", etc.) in the BATCH SELECTOR function (→ 148). Example: If BATCH # 1 was selected in the BATCH SELECTOR function (7200), then only the values from BATCH # 1 (batch name, batch quantity etc.) can be displayed.</p> <p>(continued on next page)</p>

Function description USER INTERFACE → MAIN LINE → CONFIGURATION	
ASSIGN (continued)	<p>Advanced options with optional software package CONCENTRATION: TARGET MASS FLOW % TARGET MASS FLOW TARGET VOLUME FLOW % TARGET VOLUME FLOW CORRECTED TARGET VOLUME FLOW CARRIER MASS FLOW % CARRIER MASS FLOW CARRIER VOLUME FLOW % CARRIER VOLUME FLOW CORRECTED CARRIER VOLUME FLOW % BLACK LIQUOR °BAUME °API °PLATO °BALLING °BRX OTHERS (_ _ _ _ flexible concentration)</p> <p>Advanced options with optional software package ADVANCED DIAGNOSIS: MASS FLOW DEVIATION DENSITY DEVIATION REFERENCE DENSITY DEVIATION TEMPERATURE DEVIATION TUBE DAMPING DEVIATION ELECTRODYNAMIC SENSOR DEVIATION OPERATING FREQUENCY FLUCTUATION DEVIATION TUBE DAMPING FLUCTUATION DEVIATION</p>
100% VALUE (2201)	<p> Note! This function is not available unless one of the following was selected in the ASSIGN function (2200):</p> <ul style="list-style-type: none"> ▪ MASS FLOW IN % ▪ VOLUME FLOW IN % ▪ CORRECTED VOLUME FLOW IN % <p>Use this function to define the flow value to be shown on the display as the 100% value.</p> <p>User input: 5-digit floating-point number</p> <p>Factory setting: 10 kg/s, 10 l/s or 10 NI/s</p>
FORMAT (2202)	<p>Use this function to define the maximum number of places after the decimal point displayed for the reading in the main line.</p> <p>Options: XXXXX. - XXXX.X - XXX.XX - XX.XXX -X.XXXX</p> <p>Factory setting: X.XXXX</p> <p> Note!</p> <ul style="list-style-type: none"> ▪ Note that this setting only affects the reading as it appears on the display, it has no influence on the accuracy of the system's calculations. ▪ The places after the decimal point as computed by the measuring device cannot always be displayed, depending on this setting and the engineering unit. In such instances an arrow appears on the display between the measuring value and the engineering unit (e.g. 1.2 → kg/h), indicating that the measuring system is computing with more decimal places than can be shown on the display.

5.2.2 Function group MULTIPLEX

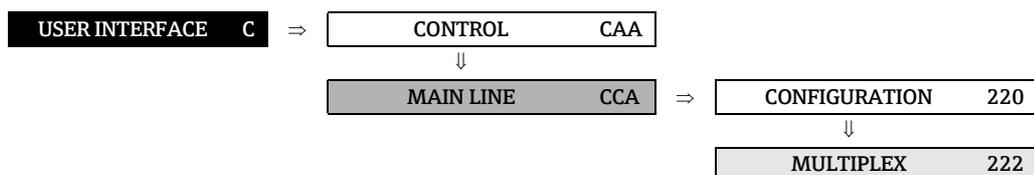

Function description	
USER INTERFACE → MAIN LINE → MULTIPLEX	
ASSIGN (2220)	<p>Use this function to define the second reading to be displayed in the main line alternately (every 10 seconds) with the value defined in the ASSIGN function (2200).</p> <p>Options (standard): OFF MASS FLOW MASS FLOW IN % VOLUME FLOW VOLUME FLOW IN % CORRECTED VOLUME FLOW CORRECTED VOLUME FLOW IN % DENSITY REFERENCE DENSITY TEMPERATURE ACTUAL CURRENT (1...3) ACTUAL FREQUENCY (1...2) TOTALIZER (1...3) ACTUAL CURRENT INPUT</p> <p>Factory setting: OFF</p> <p>Advanced options with optional software package BATCHING: BATCH NAME ("BATCH # 1" or "BEER 330", etc.) BATCH QUANTITY (overall quantity to be batched) BATCH COUNTER (batching processes carried out) BATCH SUM (effective total batching quantity)</p> <p> Note! The options given in the BATCHING software package always refer to the batching selected ("BATCH # 1", "BATCH # 2", etc.) in the BATCH SELECTOR function (→ 148). Example: If BATCH # 1 was selected in the BATCH SELECTOR function (7200), then only the values from BATCH # 1 (batch name, batch quantity etc.) can be displayed.</p> <p>Advanced options with optional software package CONCENTRATION: TARGET MASS FLOW % TARGET MASS FLOW TARGET VOLUME FLOW % TARGET VOLUME FLOW CORRECTED TARGET VOLUME FLOW CARRIER MASS FLOW % CARRIER MASS FLOW CARRIER VOLUME FLOW % CARRIER VOLUME FLOW CORRECTED CARRIER VOLUME FLOW % BLACK LIQUOR °BAUME °API °PLATO °BALLING °BRX OTHERS (_ _ _ _ flexible concentration)</p> <p>(continued on next page)</p>

Function description	
USER INTERFACE → MAIN LINE → MULTIPLEX	
ASSIGN (continued)	<p>Advanced options with optional software package ADVANCED DIAGNOSIS:</p> <p>MASS FLOW DEVIATION DENSITY DEVIATION REFERENCE DENSITY DEVIATION TEMPERATURE DEVIATION TUBE DAMPING DEVIATION ELECTRODYNAMIC SENSOR DEVIATION OPERATING FREQUENCY FLUCTUATION DEVIATION TUBE DAMPING FLUCTUATION DEVIATION</p>
100% VALUE (2221)	<p> Note!</p> <p>This function is not available unless one of the following was selected in the ASSIGN function (2220):</p> <ul style="list-style-type: none"> ▪ MASS FLOW IN % ▪ VOLUME FLOW IN % ▪ CORRECTED VOLUME FLOW IN % <p>Use this function to define the flow value to be shown on the display as the 100% value.</p> <p>User input: 5-digit floating-point number</p> <p>Factory setting: 10 kg/s, 10 l/s or 10 NI/s</p>
FORMAT (2222)	<p>Use this function to define the maximum number of places after the decimal point for the second value displayed in the main line.</p> <p>Options: XXXXX. - XXXX.X - XXX.XX - XX.XXX -X.XXXX</p> <p>Factory setting: X.XXXX</p> <p> Note!</p> <ul style="list-style-type: none"> ▪ Note that this setting only affects the reading as it appears on the display, it has no influence on the accuracy of the system's calculations. ▪ The places after the decimal point as computed by the measuring device cannot always be displayed, depending on this setting and the engineering unit. In such instances an arrow appears on the display between the measuring value and the engineering unit (e.g. 1.2 → kg/h), indicating that the measuring system is computing with more decimal places than can be shown on the display.

5.3 Group ADDITIONAL LINE

5.3.1 Function group CONFIGURATION

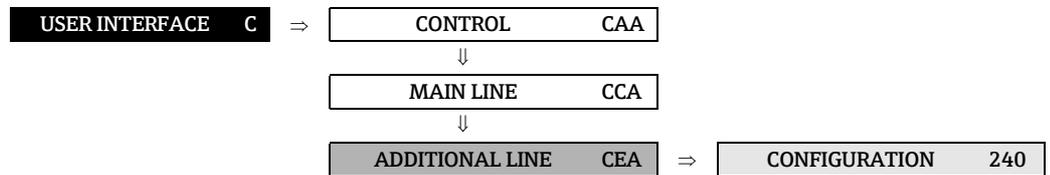

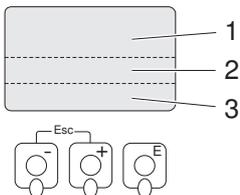
Function description USER INTERFACE → ADDITIONAL LINE → CONFIGURATION	
	
A0001253	
1 = main line, 2 = additional line, 3 = information line	
ASSIGN (2400)	<p>In this function, a value to be displayed is assigned to the additional line (middle line in the local display). This value is displayed during normal operation.</p> <p>Options (standard): OFF MASS FLOW MASS FLOW IN % VOLUME FLOW VOLUME FLOW IN % CORRECTED VOLUME FLOW CORRECTED VOLUME FLOW IN % DENSITY REFERENCE DENSITY TEMPERATURE MASS FLOW BARGRAPH IN % VOLUME FLOW BARGRAPH IN % CORRECTED VOLUME FLOW BARGRAPH IN % ACTUAL CURRENT (1...3) ACTUAL FREQUENCY (1...2) TOTALIZER (1...3) TAG NAME ACTUAL CURRENT INPUT LONG TAG 1...16 (only HART7)* LONG TAG 17...28(only HART7)*</p> <p>*Byte 29 to 32 only selectable in INFORMATION LINE → 51</p> <p>Factory setting: TOTALIZER 1</p> <p>Advanced options with optional software package BATCHING: BATCH NAME ("BATCH # 1" or "BEER 330", etc.) BATCH QUANTITY (overall quantity to be batched) BATCH COUNTER (batching processes carried out) BATCH SUM (effective total batching quantity) BATCH UPWARDS (batching progress upwards) BATCH DOWNWARDS (batching progress downwards)</p> <p>(continued on next page)</p>

Function description	
USER INTERFACE → ADDITIONAL LINE → CONFIGURATION	
ASSIGN (continued)	<p> Note! The options given in the BATCHING software package always refer to the batching selected ("BATCH # 1", "BATCH # 2", etc.) in the BATCH SELECTOR function (→ 148). Example: If BATCH # 1 was selected in the BATCH SELECTOR function (7200), then only the values from BATCH # 1 (batch name, batch quantity etc.) can be displayed.</p> <p>Advanced options with optional software package CONCENTRATION: TARGET MASS FLOW % TARGET MASS FLOW TARGET VOLUME FLOW % TARGET VOLUME FLOW CORRECTED TARGET VOLUME FLOW CARRIER MASS FLOW % CARRIER MASS FLOW CARRIER VOLUME FLOW % CARRIER VOLUME FLOW CORRECTED CARRIER VOLUME FLOW % BLACK LIQUOR ° BAUME ° API ° PLATO ° BALLING ° BRIX OTHERS (_ _ _ _ flexible concentration)</p> <p>Advanced options with optional software package ADVANCED DIAGNOSIS: MASS FLOW DEVIATION DENSITY DEVIATION REFERENCE DENSITY DEVIATION TEMPERATURE DEVIATION TUBE DAMPING DEVIATION ELECTRODYNAMIC SENSOR DEVIATION OPERATING FREQUENCY FLUCTUATION DEVIATION TUBE DAMPING FLUCTUATION DEVIATION</p>
100% VALUE (2401)	<p> Note! This function is not available unless one of the following was selected in the ASSIGN function (2400):</p> <ul style="list-style-type: none"> ■ MASS FLOW IN % ■ VOLUME FLOW IN % ■ CORRECTED VOLUME FLOW IN % ■ MASS FLOW BARGRAPH IN % ■ VOLUME FLOW BARGRAPH IN % ■ CORRECTED VOLUME FLOW BARGRAPH IN % <p>Use this function to define the flow value to be shown on the display as the 100% value.</p> <p>User input: 5-digit floating-point number</p> <p>Factory setting: 10 kg/s, 10 l/s or 10 NI/s</p>

Function description	
USER INTERFACE → ADDITIONAL LINE → CONFIGURATION	
FORMAT (2402)	<p> Note! This function is not available unless a number was selected in the ASSIGN function (2400).</p> <p>Use this function to define the maximum number of places after the decimal point displayed for the reading in the additional line.</p> <p>Options: XXXXX. - XXXX.X - XXX.XX - XX.XXX -X.XXXX</p> <p>Factory setting: X.XXXX</p> <p> Note!</p> <ul style="list-style-type: none"> ▪ Note that this setting only affects the reading as it appears on the display, it has no influence on the accuracy of the system's calculations. ▪ The places after the decimal point as computed by the measuring device cannot always be displayed, depending on this setting and the engineering unit. In such instances an arrow appears on the display between the measuring value and the engineering unit (e.g. 1.2 → kg/h), indicating that the measuring system is computing with more decimal places than can be shown on the display.
DISPLAY MODE (2403)	<p> Note! This function is not available unless one of the following was selected in the ASSIGN function (2400):</p> <ul style="list-style-type: none"> ▪ MASS FLOW BARGRAPH IN % ▪ VOLUME FLOW BARGRAPH IN % ▪ CORRECTED VOLUME FLOW BARGRAPH IN % <p>Use this function to define the format of the bar graph.</p> <p>Options: STANDARD Simple bar graph with 25 / 50 / 75% gradations and integrated sign.</p> <div style="text-align: center;">  </div> <p style="text-align: right; font-size: small;">A0001258</p> <p>SYMMETRY Symmetrical bar graph for positive and negative directions of flow, with -50 / 0 / +50% gradations and integrated sign..</p> <div style="text-align: center;">  </div> <p style="text-align: right; font-size: small;">A0001259</p> <p>Factory setting: STANDARD</p>

5.3.2 Function group MULTIPLEX

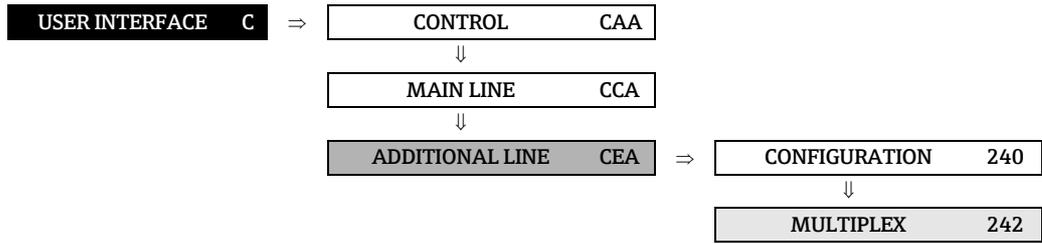

Function description	
USER INTERFACE → ADDITIONAL LINE → MULTIPLEX	
ASSIGN (2420)	<p>Use this function to define the second reading to be displayed in the additional line alternately (every 10 seconds) with the value defined in the function ASSIGN (2400).</p> <p>Options (standard): OFF MASS FLOW MASS FLOW IN % VOLUME FLOW VOLUME FLOW IN % CORRECTED VOLUME FLOW CORRECTED VOLUME FLOW IN % DENSITY REFERENCE DENSITY TEMPERATURE MASS FLOW BARGRAPH IN % VOLUME FLOW BARGRAPH IN % CORRECTED VOLUME FLOW BARGRAPH IN % ACTUAL CURRENT (1...3) ACTUAL FREQUENCY (1...2) TOTALIZER (1...3) TAG NAME ACTUAL CURRENT INPUT LONG TAG 1...16 (only HART7)* LONG TAG 17...28 (only HART7)*</p> <p>*Byte 29 to 32 only selectable in INFORMATION LINE. → 51</p> <p>Factory setting: OFF</p> <p>Advanced options with optional software package BATCHING: BATCH NAME ("BATCH # 1" or "BEER 330", etc.) BATCH QUANTITY (overall quantity to be batched) BATCH COUNTER (batching processes carried out) BATCH SUM (effective total batching quantity) BATCH UPWARDS (batching progress upwards) BATCH DOWNWARDS (batching progress downwards)</p> <p> Note! The options given in the BATCHING software package always refer to the batching selected ("BATCH # 1", "BATCH # 2", etc.) in the BATCH SELECTOR function (→ 148). Example: If BATCH # 1 was selected in the BATCH SELECTOR function (7200), then only the values from BATCH # 1 (batch name, batch quantity etc.) can be displayed.</p> <p>(continued on next page)</p>

Function description	
USER INTERFACE → ADDITIONAL LINE → MULTIPLEX	
ASSIGN (continued)	<p>Advanced options with optional software package CONCENTRATION: TARGET MASS FLOW % TARGET MASS FLOW TARGET VOLUME FLOW % TARGET VOLUME FLOW CORRECTED TARGET VOLUME FLOW CARRIER MASS FLOW % CARRIER MASS FLOW CARRIER VOLUME FLOW % CARRIER VOLUME FLOW CORRECTED CARRIER VOLUME FLOW % BLACK LIQUOR °BAUME °API °PLATO °BALLING °BRIX OTHERS (_ _ _ _ flexible concentration)</p> <p>Advanced options with optional software package ADVANCED DIAGNOSIS: MASS FLOW DEVIATION DENSITY DEVIATION REFERENCE DENSITY DEVIATION TEMPERATURE DEVIATION TUBE DAMPING DEVIATION ELECTRODYNAMIC SENSOR DEVIATION OPERATING FREQUENCY FLUCTUATION DEVIATION TUBE DAMPING FLUCTUATION DEVIATION</p> <p> Note! Multiplex mode is suspended as soon as a fault / notice message is generated. The message in question appears on the display.</p> <ul style="list-style-type: none"> ■ Fault message (identified by a lightning icon): <ul style="list-style-type: none"> - If "ON" was selected in the ACKNOWLEDGE FAULTS (8004) function, multiplex mode is continued as soon as the fault has been acknowledged and is no longer active. - If "OFF" was selected in the ACKNOWLEDGE FAULTS (8004) function, multiplex mode is continued as soon as the fault is no longer active. ■ Notice message (identified by an exclamation mark): <ul style="list-style-type: none"> - Multiplex mode is continued as soon as the notice message is no longer active.
100% VALUE (2421)	<p> Note! This function is not available unless one of the following was selected in the ASSIGN function (2420):</p> <ul style="list-style-type: none"> ■ MASS FLOW IN % ■ VOLUME FLOW IN % ■ CORRECTED VOLUME FLOW IN % ■ MASS FLOW BARGRAPH IN % ■ VOLUME FLOW BARGRAPH IN % ■ CORRECTED VOLUME FLOW BARGRAPH IN % <p>Use this function to define the flow value to be shown on the display as the 100% value.</p> <p>User input: 5-digit floating-point number</p> <p>Factory setting: 10 kg/s, 10 l/s or 10 NI/s</p>

Function description USER INTERFACE → ADDITIONAL LINE → MULTIPLEX	
FORMAT (2422)	<p> Note! This function is not available unless a number was selected in the ASSIGN function (2420).</p> <p>Use this function to define the maximum number of places after the decimal point for the second value displayed in the additional line.</p> <p>Options: XXXXX. - XXXX.X - XXX.XX - XX.XXX -X.XXXX</p> <p>Factory setting: X.XXXX</p> <p> Note!</p> <ul style="list-style-type: none"> ▪ Note that this setting only affects the reading as it appears on the display, it has no influence on the accuracy of the system's calculations. ▪ The places after the decimal point as computed by the measuring device cannot always be displayed, depending on this setting and the engineering unit. In such instances an arrow appears on the display between the measuring value and the engineering unit (e.g. 1.2 → kg/h), indicating that the measuring system is computing with more decimal places than can be shown on the display.
DISPLAY MODE (2423)	<p> Note! This function is not available unless one of the following was selected in the ASSIGN function (2420):</p> <ul style="list-style-type: none"> ▪ MASS FLOW BARGRAPH IN % ▪ VOLUME FLOW BARGRAPH IN % ▪ CORRECTED VOLUME FLOW BARGRAPH IN % <p>Use this function to define the format of the bar graph.</p> <p>Options: STANDARD Simple bar graph with 25 / 50 / 75% gradations and integrated sign.</p> <div style="text-align: center;">  </div> <p style="text-align: right; font-size: small;">A0001258</p> <p>SYMMETRY Symmetrical bar graph for positive and negative directions of flow, with -50 / 0 / +50% gradations and integrated sign..</p> <div style="text-align: center;">  </div> <p style="text-align: right; font-size: small;">A0001259</p> <p>Factory setting: STANDARD</p>

5.4 Group INFORMATION LINE

5.4.1 Function group CONFIGURATION

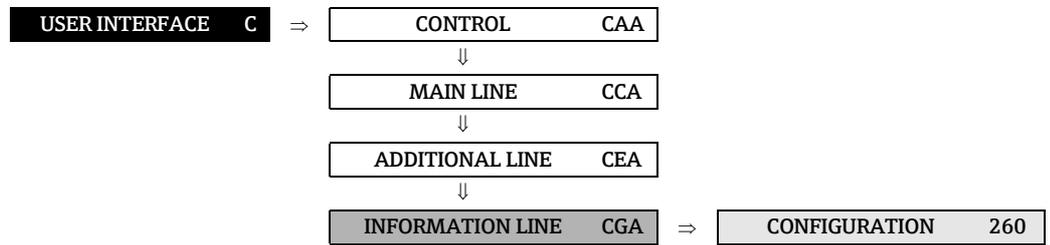

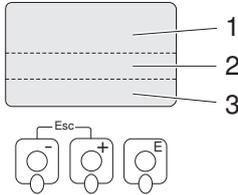
Function description	
USER INTERFACE → INFORMATION LINE → CONFIGURATION	
	
A0001253	
1 = main line, 2 = additional line, 3 = information line	
ASSIGN (2600)	<p>In this function, a value to be displayed is assigned to the information line (bottom line in the local display). This value is displayed during normal operation.</p> <p>Options: OFF MASS FLOW MASS FLOW IN % VOLUME FLOW VOLUME FLOW IN % CORRECTED VOLUME FLOW CORRECTED VOLUME FLOW IN % DENSITY REFERENCE DENSITY TEMPERATURE MASS FLOW BARGRAPH IN % VOLUME FLOW BARGRAPH IN % CORRECTED VOLUME FLOW BARGRAPH IN % ACTUAL CURRENT (1...3) ACTUAL FREQUENCY (1...2) TOTALIZER (1...3) TAG NAME OPERATING/SYSTEM CONDITIONS FLOW DIRECTION READING ACTUAL CURRENT INPUT LONG TAG 1 to 16 (only HART7) LONG TAG 15 to 28 (only HART7) LONG TAG 29 to 32 (only HART7)</p> <p>Factory setting: OPERATING/SYSTEM CONDITIONS</p> <p>(continued on next page)</p>

Function description USER INTERFACE → INFORMATION LINE → CONFIGURATION	
ASSIGN (continued)	<p>Advanced options with optional software package BATCHING: BATCHING KEYS (softkeys on the local display)</p> <p> Note!</p> <ul style="list-style-type: none"> ▪ If you select the BATCHING OPERATING KEYS, the multiplex display functionality (function ASSIGN (2620), etc.) is not available in the information line. ▪ For information on the functional concept of the batching menu, See Operating Instructions <i>Proline Promass 83</i>, BA 059D/06/en/, chapter Operation. <p>Advanced options with optional software package CONCENTRATION: TARGET MASS FLOW % TARGET MASS FLOW TARGET VOLUME FLOW % TARGET VOLUME FLOW CORRECTED TARGET VOLUME FLOW CARRIER MASS FLOW % CARRIER MASS FLOW CARRIER VOLUME FLOW % CARRIER VOLUME FLOW CORRECTED CARRIER VOLUME FLOW % BLACK LIQUOR °BAUME °API °PLATO °BALLING °BRIX OTHERS (_ _ _ _ flexible concentration)</p> <p>Advanced options with optional software package ADVANCED DIAGNOSIS: MASS FLOW DEVIATION DENSITY DEVIATION REFERENCE DENSITY DEVIATION TEMPERATURE DEVIATION TUBE DAMPING DEVIATION ELECTRODYNAMIC SENSOR DEVIATION OPERATING FREQUENCY FLUCTUATION DEVIATION TUBE DAMPING FLUCTUATION DEVIATION</p>
100% VALUE (2601)	<p> Note!</p> <p>This function is not available unless one of the following was selected in the ASSIGN function (2600):</p> <ul style="list-style-type: none"> ▪ MASS FLOW IN % ▪ VOLUME FLOW IN % ▪ CORRECTED VOLUME FLOW IN % ▪ MASS FLOW BARGRAPH IN % ▪ VOLUME FLOW BARGRAPH IN % ▪ CORRECTED VOLUME FLOW BARGRAPH IN % <p>Use this function to define the flow value to be shown on the display as the 100% value.</p> <p>User input: 5-digit floating-point number</p> <p>Factory setting: 10 kg/s, 10 l/s or 10 NI/s</p>

Function description	
USER INTERFACE → INFORMATION LINE → CONFIGURATION	
FORMAT (2602)	<p> Note! This function is not available unless a number was selected in the ASSIGN function (2600).</p> <p>Use this function to define the maximum number of places after the decimal point displayed for the reading in the information line.</p> <p>Options: XXXXX. - XXXX.X - XXX.XX - XX.XXX - X.XXXX</p> <p>Factory setting: X.XXXX</p> <p> Note!</p> <ul style="list-style-type: none"> ▪ Note that this setting only affects the reading as it appears on the display, it has no influence on the accuracy of the system's calculations. ▪ The places after the decimal point as computed by the measuring device cannot always be displayed, depending on this setting and the engineering unit. In such instances an arrow appears on the display between the measuring value and the engineering unit (e.g. 1.2 → kg/h), indicating that the measuring system is computing with more decimal places than can be shown on the display.
DISPLAY MODE (2603)	<p> Note! This function is not available unless one of the following was selected in the ASSIGN function (2600):</p> <ul style="list-style-type: none"> ▪ MASS FLOW BARGRAPH IN % ▪ VOLUME FLOW BARGRAPH IN % ▪ CORRECTED VOLUME FLOW BARGRAPH IN % <p>Use this function to define the format of the bar graph.</p> <p>Options: STANDARD Simple bar graph with 25 / 50 / 75% gradations and integrated sign.</p> <div style="text-align: center;">  </div> <p style="text-align: right; font-size: small;">A0001258</p> <p>SYMMETRY Symmetrical bar graph for positive and negative directions of flow, with -50 / 0 / +50% gradations and integrated sign..</p> <div style="text-align: center;">  </div> <p style="text-align: right; font-size: small;">A0001259</p> <p>Factory setting: STANDARD</p>

5.4.2 Function group MULTIPLEX

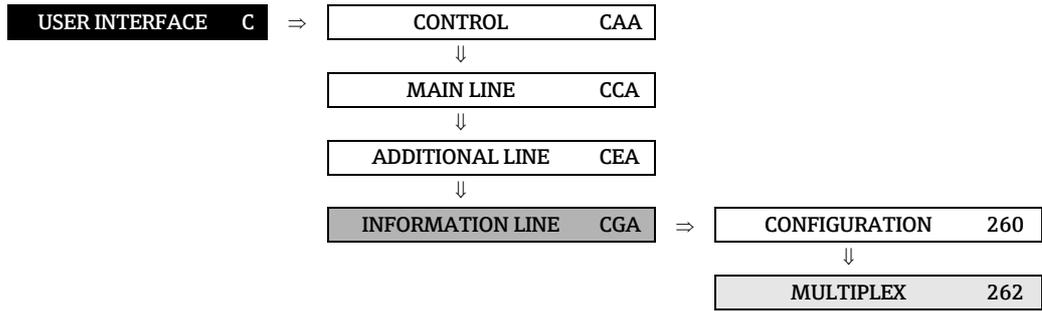

Function description	
USER INTERFACE → INFORMATION LINE → MULTIPLEX	
<p> Note! If you select the BATCHING OPERATING KEYS in the function ASSIGN (2600), the multiplex display functionality is not available in the information line.</p>	
<p>ASSIGN (2620)</p>	<p>Use this function to define the second reading to be displayed in the information line alternately (every 10 seconds) with the value defined in the function ASSIGN (2600).</p> <p>Options: OFF MASS FLOW MASS FLOW IN % VOLUME FLOW VOLUME FLOW IN % CORRECTED VOLUME FLOW CORRECTED VOLUME FLOW IN % DENSITY REFERENCE DENSITY TEMPERATURE MASS FLOW BARGRAPH IN % VOLUME FLOW BARGRAPH IN % CORRECTED VOLUME FLOW BARGRAPH IN % ACTUAL CURRENT (1...3) ACTUAL FREQUENCY (1...2) TOTALIZER (1...3) TAG NAME OPERATING/SYSTEM CONDITIONS DISPLAY FLOW DIRECTION ACTUAL CURRENT INPUT LONG TAG 1 to 16 (only HART7) LONG TAG 15 to 28 (only HART7) LONG TAG 29 to 32 (only HART7)</p> <p>Factory setting: OFF</p>
(continued on next page)	

Function description	
USER INTERFACE → INFORMATION LINE → MULTIPLEX	
ASSIGN (continued)	<p>Advanced options with optional software package CONCENTRATION: TARGET MASS FLOW % TARGET MASS FLOW TARGET VOLUME FLOW % TARGET VOLUME FLOW CORRECTED TARGET VOLUME FLOW CARRIER MASS FLOW % CARRIER MASS FLOW CARRIER VOLUME FLOW % CARRIER VOLUME FLOW CORRECTED CARRIER VOLUME FLOW % BLACK LIQUOR °BAUME °API °PLATO °BALLING °BRIX OTHERS (_ _ _ _ flexible concentration)</p> <p>Advanced options with optional software package ADVANCED DIAGNOSIS: MASS FLOW DEVIATION DENSITY DEVIATION REFERENCE DENSITY DEVIATION TEMPERATURE DEVIATION TUBE DAMPING DEVIATION ELECTRODYNAMIC SENSOR DEVIATION OPERATING FREQUENCY FLUCTUATION DEVIATION TUBE DAMPING FLUCTUATION DEVIATION</p> <p> Note! Multiplex mode is suspended as soon as a fault / notice message is generated. The message in question appears on the display.</p> <ul style="list-style-type: none"> ■ Fault message (identified by a lightning icon): <ul style="list-style-type: none"> - If "ON" was selected in the ACKNOWLEDGE FAULTS (8004) function, multiplex mode is continued as soon as the fault has been acknowledged and is no longer active. - If "OFF" was selected in the ACKNOWLEDGE FAULTS (8004) function, multiplex mode is continued as soon as the fault is no longer active. ■ Notice message (identified by an exclamation mark): <ul style="list-style-type: none"> - Multiplex mode is continued as soon as the notice message is no longer active.
100% VALUE (2621)	<p> Note! This function is not available unless one of the following was selected in the ASSIGN function (2620):</p> <ul style="list-style-type: none"> ■ MASS FLOW IN % ■ VOLUME FLOW IN % ■ CORRECTED VOLUME FLOW IN % ■ MASS FLOW BARGRAPH IN % ■ VOLUME FLOW BARGRAPH IN % ■ CORRECTED VOLUME FLOW BARGRAPH IN % <p>Use this function to define the flow value to be shown on the display as the 100% value.</p> <p>User input: 5-digit floating-point number</p> <p>Factory setting: 10 kg/s, 10 l/s or 10 NI/s</p>

Function description USER INTERFACE → INFORMATION LINE → MULTIPLEX	
FORMAT (2622)	<p> Note! This function is not available unless a number was selected in the ASSIGN function (2620).</p> <p>Use this function to define the maximum number of places after the decimal point for the second value displayed in the information line.</p> <p>Options: XXXXX. - XXXX.X - XXX.XX - XX.XXX -X.XXXX</p> <p>Factory setting: X.XXXX</p> <p> Note!</p> <ul style="list-style-type: none"> ▪ Note that this setting only affects the reading as it appears on the display, it has no influence on the accuracy of the system's calculations. ▪ The places after the decimal point as computed by the measuring device cannot always be displayed, depending on this setting and the engineering unit. In such instances an arrow appears on the display between the measuring value and the engineering unit (e.g. 1.2 → kg/h), indicating that the measuring system is computing with more decimal places than can be shown on the display.
DISPLAY MODE (2623)	<p> Note! This function is not available unless one of the following was selected in the ASSIGN function (2620):</p> <ul style="list-style-type: none"> ▪ MASS FLOW BARGRAPH IN % ▪ VOLUME FLOW BARGRAPH IN % ▪ CORRECTED VOLUME FLOW BARGRAPH IN % <p>Use this function to define the format of the bar graph.</p> <p>Options: STANDARD Simple bar graph with 25 / 50 / 75% gradations and integrated sign.</p> <div style="text-align: center;">  </div> <p style="text-align: right; font-size: small;">A0001258</p> <p>SYMMETRY Symmetrical bar graph for positive and negative directions of flow, with -50 / 0 / +50% gradations and integrated sign..</p> <div style="text-align: center;">  </div> <p style="text-align: right; font-size: small;">A0001259</p> <p>Factory setting: STANDARD</p>

6 Block TOTALIZERS

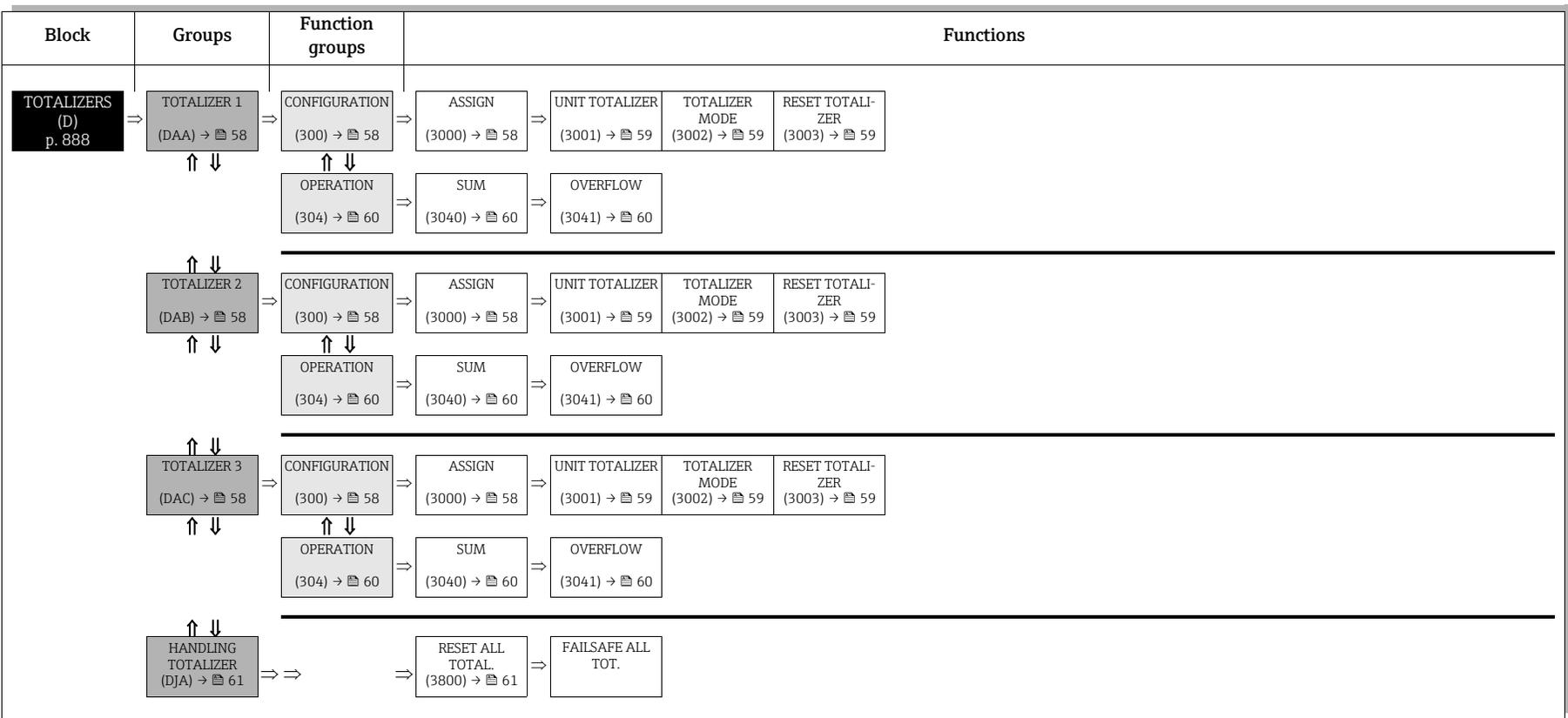

6.1 Group TOTALIZER (1 to 3)

6.1.1 Function group CONFIGURATION

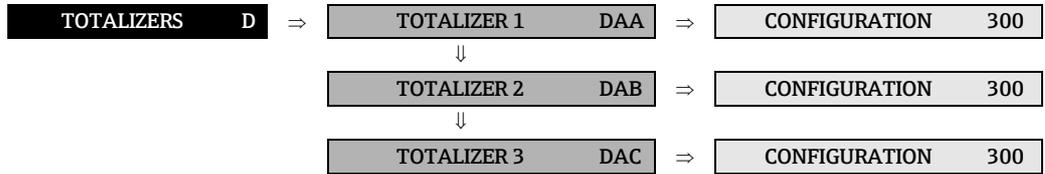

Function description	
TOTALIZERS → TOTALIZER (1 to 3) → CONFIGURATION	
The function descriptions below apply to totalizers 1 to 3; the totalizers are independently configurable.	
ASSIGN (3000)	<p>Use this function to assign a measured variable to the totalizer in question.</p> <p>Options (standard): OFF MASS FLOW VOLUME FLOW CORRECTED VOLUME FLOW</p> <p>Advanced options with optional software package CONCENTRATION: TARGET MASS TARGET VOLUME TARGET CORRECTED VOLUME CARRIER MASS CARRIER VOLUME CARRIER CORRECTED VOLUME</p> <p>Factory setting: MASS FLOW</p> <p> Note!</p> <ul style="list-style-type: none"> ▪ The totalizer is reset to “0” as soon as the selection is changed. ▪ If you select OFF in the function group CONFIGURATION of the totalizer in question, only the ASSIGN (3000) function remains visible.

Function description	
TOTALIZERS → TOTALIZER (1 to 3) → CONFIGURATION	
UNIT TOTALIZER (3001)	<p>Use this function to define the unit for the totalizer's measured variable, as selected beforehand.</p> <p>Options (for the MASS FLOW assignment): Metric → g; kg; t</p> <p>US → oz; lb; ton</p> <p>Arbitrary unit → _ _ _ _</p> <p>Factory setting: kg</p> <p>Options (for the VOLUME FLOW assignment): Metric → cm³; dm³; m³; ml; l; hl; Ml Mega</p> <p>US → cc; af; ft³; oz f; gal; Kgal; Mgal; bbl (normal fluids); bbl (beer); bbl (petrochemicals); bbl (filling tanks)</p> <p>Imperial → gal; Mgal; bbl (beer); bbl (petrochemicals)</p> <p>Arbitrary unit → _ _ _ _</p> <p>Factory setting: m³</p> <p>Options (for the CORRECTED VOLUME FLOW assignment): Metric → Nl; Nm³</p> <p>US → Sm³; Scf</p> <p>Factory setting: Nm³</p>
TOTALIZER MODE (3002)	<p>Use this function to define how the flow components are to be totalized.</p> <p>Options: BALANCE Positive and negative flow components. The positive and negative flow components are balanced. In other words, net flow in the flow direction is registered.</p> <p>FORWARD (only positive flow components) REVERSE (only negative flow components)</p> <p>Factory setting: Totalizer 1 = BALANCE Totalizer 2 = FORWARD Totalizer 3 = REVERSE</p>
RESET TOTALIZER (3003)	<p>Use this function to reset the sum and the overflow of the totalizer to zero.</p> <p>Options: NO YES</p> <p>Factory setting: NO</p> <p> Note! If the device is equipped with a status input, with the appropriate configuration a reset for each individual totalizer can also be triggered by a pulse (see the function ASSIGN STATUS INPUT (5000) on →  114).</p>

6.1.2 Function group OPERATION

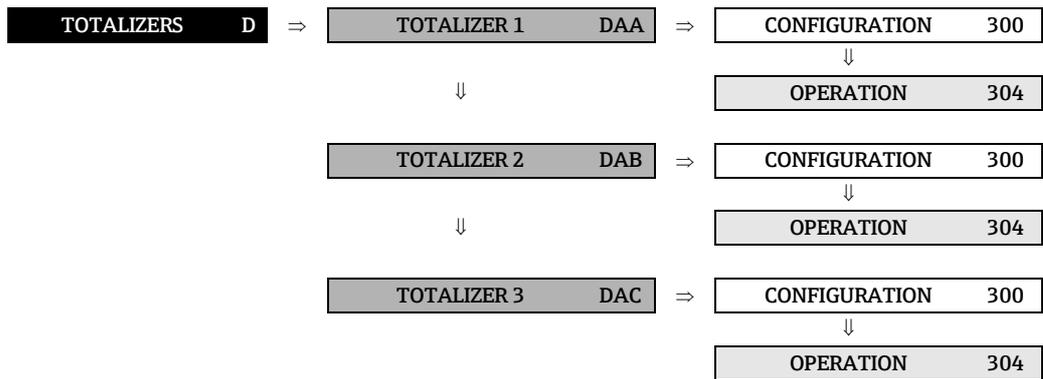

Function description	
TOTALIZERS → TOTALIZER (1 to 3) → OPERATION	
The function descriptions below apply to totalizers 1...3; the totalizers are independently configurable.	
SUM (3040)	<p>Use this function to view the total for the totalizer's measured variable aggregated since measuring commenced. The value can be positive or negative, depending on the setting selected in the function "TOTALIZER MODE" (3002), and the direction of flow.</p> <p>Display: max. 7-digit floating-point number, including sign and unit (e.g. 15467.04 m³; -4925.631 kg)</p> <p> Note!</p> <ul style="list-style-type: none"> ▪ The effect of the setting in the "TOTALIZER MODE" function (see →  59) is as follows: <ul style="list-style-type: none"> - If the setting is "BALANCE", the totalizer balances flow in the positive and negative directions. - If the setting is "FORWARD", the totalizer registers only flow in the positive direction. - If the setting is "REVERSE", the totalizer registers only flow in the negative direction. ▪ The totalizer's response to faults is defined in the "FAILSAFE ALL TOTALIZERS" function (3801), (see →  61).
OVERFLOW (3041)	<p>Use this function to view the overflow for the totalizer aggregated since measuring commenced.</p> <p>Total flow quantity is represented by a floating-point number consisting of max. 7 digits. You can use this function to view higher numerical values (>9,999,999) as overflows. The effective quantity is thus the total of OVERFLOW plus the value returned by the SUM function.</p> <p>Example: Reading for 2 overflows: $2 \cdot 10^7$ kg (= 20,000,000 kg) The value displayed in the function SUM = 196,845.7 kg Effective total quantity = 20,196,845.7 kg</p> <p>Display: integer with exponent, including sign and unit, e.g. $2 \cdot 10^7$ kg</p>

6.2 Group HANDLING TOTALIZER

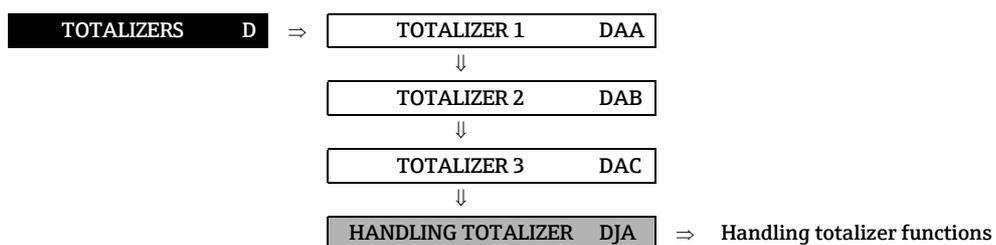

Function description	
TOTALIZERS → HANDLING TOTALIZER → Handling totalizer functions	
RESET ALL TOTALIZERS (3800)	<p>Use this function to reset the totals (including all overflows) of the totalizers (1...3) to "zero" (= RESET).</p> <p>Options: NO YES</p> <p>Factory setting: NO</p> <p> Note! If the device has a status input and if it is appropriately configured, a reset for the totalizer (1...3) can also be triggered by a pulse (see the ASSIGN STATUS INPUT function (5000) on → 114).</p>
FAILSAFE ALL TOTALIZERS (3801)	<p>Use this function to define the common response of all totalizers (1...3) in case of error.</p> <p>Options: STOP The totalizer is paused until the fault is rectified.</p> <p>ACTUAL VALUE The totalizer continues to count based on the current flow measuring value. The fault is ignored .</p> <p>HOLD VALUE The totalizer continues to count the flow that based on the last valid flow value (before the fault occurred).</p> <p>Factory setting: STOP</p>

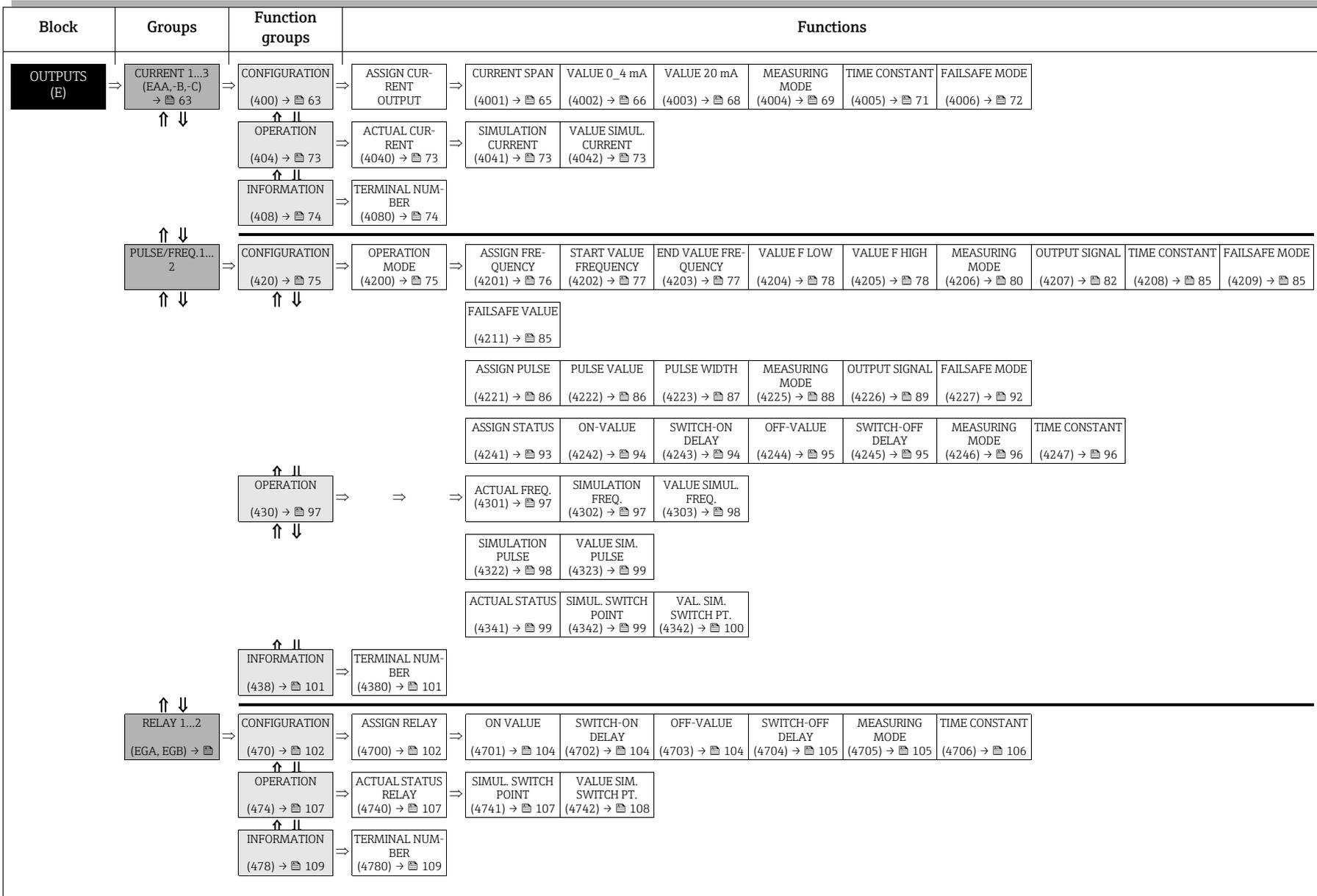

7 Block OUTPUTS

7.1 Group CURRENT OUTPUT (1 to 3)

7.1.1 Function group CONFIGURATION

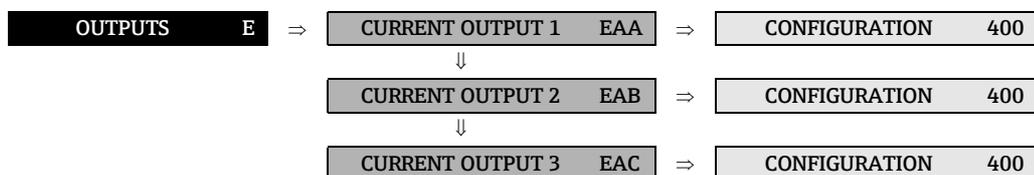

Function description	
OUTPUTS → CURRENT OUTPUT (1 to 3) → CONFIGURATION	
ASSIGN CURRENT OUTPUT (4000)	<p>Use this function to assign a measured variable to the current output.</p> <p>Options: OFF MASS FLOW VOLUME FLOW CORRECTED VOLUME FLOW DENSITY REFERENCE DENSITY TEMPERATURE</p> <p>Advanced options with optional software package BATCHING: BATCH UPWARDS (batching progress upwards) BATCH DOWNWARDS (batching progress downwards)</p> <p> Note!</p> <ul style="list-style-type: none"> ▪ The current range selected (function CURRENT SPAN (4001)) corresponds to a batching rate of 0 – 100%, based on the batching quantity. ▪ The batching software automatically sets the values for 0/4 mA (function VALUE 0_4 mA (4002) and VALUE 20 mA (4003)). Example with upward batching: Value 0/4 mA = 0 [unit]; value 20 mA = batching quantity [unit]. <p>Advanced options with optional software package CONCENTRATION: TARGET MASS FLOW % TARGET MASS FLOW TARGET VOLUME FLOW % TARGET VOLUME FLOW CORRECTED TARGET VOLUME FLOW CARRIER MASS FLOW % CARRIER MASS FLOW CARRIER VOLUME FLOW % CARRIER VOLUME FLOW CORRECTED CARRIER VOLUME FLOW % BLACK LIQUOR °BAUME °API °PLATO °BALLING °BRIX OTHERS (_ _ _ _ flexible concentration)</p> <p>(continued on next page)</p>

Function description	
OUTPUTS → CURRENT OUTPUT (1 to 3) → CONFIGURATION	
<p>ASSIGN CURRENT OUTPUT (continued)</p>	<p>Advanced options with optional software package ADVANCED DIAGNOSIS: MASS FLOW DEVIATION DENSITY DEVIATION REFERENCE DENSITY DEVIATION TEMPERATURE DEVIATION TUBE DAMPING DEVIATION ELECTRODYNAMIC SENSOR DEVIATION OPERATING FREQUENCY FLUCTUATION DEVIATION TUBE DAMPING FLUCTUATION DEVIATION</p> <p>Factory setting: MASS FLOW</p> <p> Note! If you select OFF, the only function shown in the CONFIGURATION function group is this function, in other words ASSIGN CURRENT OUTPUT (4000).</p>

Function description

OUTPUTS → CURRENT OUTPUT (1 to 3) → CONFIGURATION

**CURRENT SPAN
(4001)**

Use this function to define the current range. The selection specifies the operational range and the lower and upper signal on alarm. For the current output 1 the option HART can be defined additionally.

Options:

0-20 mA
 4-20 mA
 4-20 mA HART (only current output 1)
 4-20 mA NAMUR
 4-20 mA HART NAMUR (only current output 1)
 4-20 mA US
 4-20 mA HART US (only current output 1)
 0-20 mA (25 mA)
 4-20 mA (25 mA)
 4-20 mA (25 mA) HART (only current output 1)

Factory setting:

4-20 mA HART NAMUR (current output 1)
 4-20 mA NAMUR (current output 2...3)

 Note!

- The option HART is only supported by the current output designated as current output 1 in the device software, (terminals 26 and 27, see function TERMINAL NUMBER (4080) on →  74).
- When switching the hardware from an active (factory setting) to a passive output signal select a current span of 4-20 mA (See Operating Instructions *Proline Promass 83*, BA 059D/06/en/).

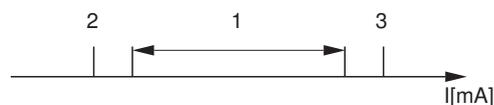
Current span, operational range and signal on alarm level

a	1	2	3
0-20 mA	0 - 20.5 mA	0	22
4-20 mA	4 - 20.5 mA	2	22
4-20 mA NAMUR	3.8 - 20.5 mA	3.5	22.6
4-20 mA US	3.9 - 20.8 mA	3.75	22.6
0-20 mA (25 mA)	0 - 24 mA	0	25
4-20 mA (25 mA)	4 - 24 mA	2	25

A0001222

a = Current span

1 = Operational range (measuring information)

2 = Lower signal on alarm level

3 = Upper signal on alarm level

 Note!

- If the measured value exceeds the measuring range (as defined in the functions VALUE 0_4 mA (4002) and VALUE 20 mA (4003)) a notice message is generated (#351...354, current span).
- In case of a fault the behavior of the current output is according to the selected option in the function FAILSAFE MODE (4006). Change the error category in the function ASSIGN SYSTEM ERROR (8000) to generate a fault message instead of a notice message.

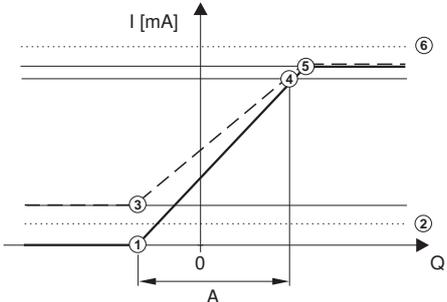
Function description	
OUTPUTS → CURRENT OUTPUT (1 to 3) → CONFIGURATION	
VALUE 0_4 mA (4002)	<p>Use this function to assign the 0/4 mA current a value. The value can be higher or lower than the value assigned to 20 mA (function VALUE 20 mA (4003), see → 68). Positive and negative values are permissible, depending on the measured variable in question (e.g. mass flow).</p> <p>Example: 4 mA assigned value = - 250 kg/h 20 mA assigned value = +750 kg/h Calculated current value = 8 mA (at zero flow)</p> <p> Note! Note that values with different signs cannot be entered for 0/4 mA and 20 mA (function 4003) if SYMMETRY is the setting selected for the MEASURING MODE function (4004). In this case, the message "INPUT RANGE EXCEEDED" appears on the display.</p> <p>Example for STANDARD measuring mode:</p> <div style="text-align: center;">  </div> <p style="text-align: right;">A0001223</p> <p>① = Initial value (0 to 20 mA) ② = Lower signal on alarm level: depends on the setting in the function CURRENT SPAN ③ = Initial value (4 to 20 mA): depends on the setting in the function CURRENT SPAN ④ = Full scale value (0/4 to 20 mA): depends on the setting in the function CURRENT SPAN ⑤ = Maximum current value: depends on the setting in the function CURRENT SPAN ⑥ = Failsafe mode (upper signal on alarm level): depends on the setting in the functions CURRENT SPAN (→ 65) and FAILSAFE MODE, (→ 61) A = Measuring range</p> <p>User input: 5-digit floating-point number, with sign</p> <p>Factory setting: 0 [kg/h] or 0.5 [kg/l] or -50 [°C]</p> <p> Note!</p> <ul style="list-style-type: none"> ■ The appropriate unit is taken from the following functions: <ul style="list-style-type: none"> - UNIT MASS FLOW (0400) - UNIT VOLUME FLOW (0402) - UNIT CORRECTED VOLUME FLOW (0404) - UNIT DENSITY (0420) - UNIT REFERENCE DENSITY (0421) - UNIT TEMPERATURE (0422) (see → 17 till → 21). ■ If the option BATCH UPWARDS or BATCH DOWNWARDS (only possible with the optional software package BATCHING) is selected in the function ASSIGN CURRENT OUTPUT (4000), the value 0/4 mA is automatically specified in this function and cannot be edited. <p> Caution! The current output responds differently, depending on the parameters set in the various functions. Some examples of parameter settings and their effect on the current output are given in the following section.</p>

Function description

OUTPUTS → CURRENT OUTPUT (1 to 3) → CONFIGURATION

VALUE 0_4 mA
(continued)

Parameter setting example A:

1. VALUE 0_4 mA (4002) = not equal to zero flow (e.g. -5 kg/h)
VALUE 20 mA (4003) = not equal to zero flow (e.g. 10 kg/h) or
2. VALUE 0_4 mA (4002) = not equal to zero flow (e.g. 100 kg/h)
VALUE 20 mA (4003) = not equal to zero flow (e.g. -40 kg/h)

and MEASURING MODE (4004) = STANDARD

When you enter the values for 0/4 mA and 20 mA, the working range of the measuring device is defined. If the effective flow drops below or exceeds this working range (see Fig. ①), a fault/notice message is generated (#351-354, current range) and the current output responds in accordance with the parameter settings in the function FAILSAFE MODE (4006).



A0001262

Parameter setting example B:

1. VALUE 0_4 mA (4002) = equal to zero flow (e.g. 0 kg/h)
VALUE 20 mA (4003) = not equal to zero flow (e.g. 10 kg/h) or
2. VALUE 0_4 mA (4002) = not equal to zero flow (e.g. 100 kg/h)
VALUE 20 mA (4003) = equal to zero flow (e.g. 0 kg/h)

and MEASURING MODE (4004) = STANDARD

When you enter the values for 0/4 mA and 20 mA, the working range of the measuring device is defined. In doing so, one of the two values is configured as zero flow (e.g. 0 kg/h).

If the effective flow drops below or exceeds the value configured as the zero flow, no fault/notice message is generated and the current output retains its value.

If the effective flow drops below or exceeds the other value, a fault/notice message is generated (#351-354, current range) and the current output responds in accordance with the parameter settings in the function FAILSAFE MODE (4006).



A0001264

Deliberately only one flow direction is output with this setting and flow values in the other flow direction are suppressed.

Parameter setting example C:

MEASURING MODE (4004) = SYMMETRY

The current output signal is independent of the direction of flow (absolute amount of the measured variable). The 0_4 mA value ① and the 20 mA value ② must have the same sign (+ or -). The "20 mA VALUE" ③ (e.g. backflow) corresponds to the mirrored 20 mA VALUE ② (e.g. flow).

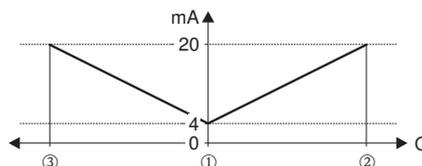

A0001249

ASSIGN RELAY (4700) = FLOW DIRECTION

With this setting e.g. the flow direction output via a switching contact can be made.

Parameter setting example D:

MEASURING MODE (4004) = PULSATING FLOW → 69

Function description	
OUTPUTS → CURRENT OUTPUT (1 to 3) → CONFIGURATION	
VALUE 20 mA (4003)	<p>Use this function to assign the 20 mA current a value. The value can be higher or lower than the value assigned to 0/4 (function VALUE 0_4 mA (4002), see →  66). Positive and negative values are permissible, depending on the measured variable in question (e.g. mass flow).</p> <p>Example: 4 mA assigned value = -250 kg/h 20 mA assigned value = +750 kg/h Calculated current value = 8 mA (at zero flow)</p> <p> Note! Note that values with different signs cannot be entered for 0/4 mA (function 4002) and 20 mA, if SYMMETRY is the setting selected in the function MEASURING MODE (4004). In this case, the message "INPUT RANGE EXCEEDED" appears.</p> <p>User input: 5-digit floating-point number, with sign</p> <p>Factory setting: Depends on nominal diameter [kg/h] or 2 [kg/l] or 200 [°C]</p> <p> Note!</p> <ul style="list-style-type: none"> ▪ The appropriate unit is taken from the following functions: <ul style="list-style-type: none"> - UNIT MASS FLOW(0400) - UNIT VOLUME FLOW(0402) - UNIT CORRECTED VOLUME FLOW(0404) - UNIT DENSITY(0420) - UNIT REFERENCE DENSITY(0421) - UNIT TEMPERATURE(0422) (sea →  17 till →  21). ▪ If the option BATCH UPWARDS or BATCH DOWNWARDS, (only possible with the optional software package BATCHING) is selected in the function ASSIGN CURRENT OUTPUT (4000), the value 20 mA is automatically specified in this function and cannot be edited. ▪ The appropriate unit is taken from the function UNIT MASS FLOW (0400) (see →  17). ▪ A description of the selection STANDARD in the function MEASURING MODE is given on →  69. <p> Caution! It is very important to read and comply with the information in the function VALUE 0_4 mA (under "Caution"; Examples of parameter settings) on →  66.</p>

Function description

OUTPUTS → CURRENT OUTPUT (1 to 3) → CONFIGURATION

MEASURING MODE
(4004)

Use this function to define the measuring mode for the current output.

Options:

STANDARD
SYMMETRY
PULSATING FLOW

Factory setting:

STANDARD

Description of the individual options:

■ STANDARD

The current output signal is proportional to the measured variable. The flow components outside the scaled measuring range (defined by the 0_4 mA VALUE ① and the 20 mA VALUE ②) are taken into account as follows for signal output.

- If one of the values is defined as equal to the zero flow (e.g. VALUE 0_4 mA = 0 kg/h), no message is given if this value is exceeded or not achieved and the current output retains its value (in example 4 mA).

If the other value is exceeded or not achieved, the message "CURRENT OUTPUT AT FULL SCALE VALUE" appears and the current output responds in accordance with the parameter setting in the function FAILSAFE MODE (4006).

- If both values defined are not equal to the zero flow (for example VALUE 0_4 mA = -5 kg/h, VALUE 20 mA = 10 kg/h), the message "CURRENT OUTPUT AT FULL SCALE VALUE" appears if the measuring range is exceeded or not achieved and the current output responds in accordance with the parameter settings in the function FAILSAFE MODE (4006).

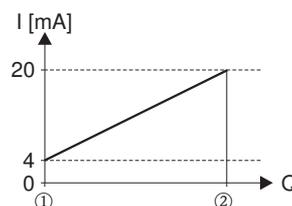

A0001248

■ SYMMETRY

The current output signal is independent of the direction of flow (absolute amount of the measured variable). The 0_4 mA VALUE ① and the 20 mA VALUE ② must have the same sign (+ or -). The "20 mA VALUE" ③ (e.g. backflow) corresponds to the mirrored 20 mA VALUE ② (e.g. flow).

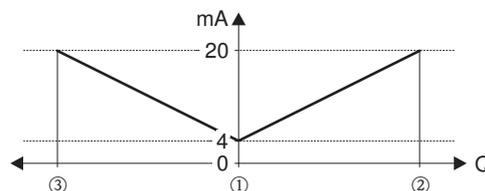

A0001249

Note!

- The direction of flow can be output via the configurable relay or status outputs.
- SYMMETRY cannot be selected unless the values in the VALUE 0_4 mA (4002) and VALUE 20 mA (4003) functions have the same sign or one of the values is zero. If the values have different signs, SYMMETRY cannot be selected and an "ASSIGNMENT NOT POSSIBLE" message is displayed.

(continued on next page)

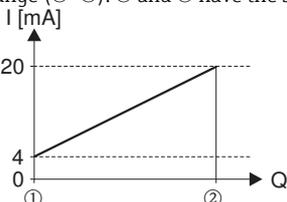
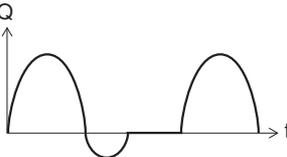
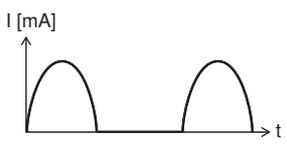
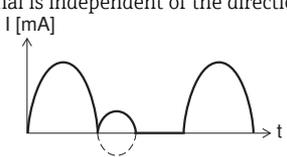
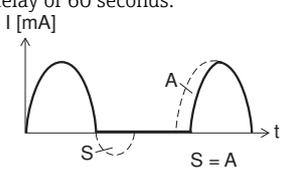
Function description	
OUTPUTS → CURRENT OUTPUT (1 to 3) → CONFIGURATION	
<p>MEASURING MODE (continued)</p>	<ul style="list-style-type: none"> PULSATING FLOW If flow is characterized by severe fluctuations as is the case, for example, with reciprocating pumps, flow components outside the measuring range are buffered, balanced and output after a maximum delay of 60 seconds. If the buffered data cannot be processed within approx. 60 seconds, a fault/notice message appears. Under certain plant conditions, flow values can aggregate in the buffer, for example in the case of prolonged and unwanted fluid backflow. However, this buffer is reset in all relevant programming adjustments which affect the current output. <p> Caution! If the option BATCH UPWARDS or BATCH DOWNWARDS is selected in the function ASSIGN CURRENT OUTPUT (4000), the option is automatically specified and cannot be edited.</p>
<p>Detailed explanations and information</p>	<p>How the current output responds under the following postulated conditions:</p> <ol style="list-style-type: none"> Defined measuring range (①-②): ① and ② have the same sign  <p style="text-align: right;">A0001248</p> <p>and the following flow behavior:</p>  <p style="text-align: right;">A0001265</p> STANDARD The current output signal is proportional to the measured variable. The flow components outside the scaled measuring range are not taken into account for signal output.  <p style="text-align: right;">A0001267</p> <ol style="list-style-type: none"> SYMMETRY The current output signal is independent of the direction of flow.  <p style="text-align: right;">A0001268</p> <ol style="list-style-type: none"> PULSATING FLOW Flow components outside the measuring range are buffered, balanced and output after a maximum delay of 60 seconds.  <p style="text-align: right;">A0001269</p>
	<p>(continued on next page)</p>

Function description	
OUTPUTS → CURRENT OUTPUT (1 to 3) → CONFIGURATION	
<p>Detailed explanations and information (continued)</p>	<p>2. Defined measuring range (①-②): ① and ② have different signs</p> <p style="text-align: right;">A0001272</p> <p>Flow a (-) outside, b (- -) within the measuring range.</p> <p style="text-align: right;">A0001273</p> <ul style="list-style-type: none"> ▪ STANDARD <ul style="list-style-type: none"> a (-): The flow components outside the scaled measuring range cannot be taken into account for signal output. A fault message is generated (# 351...354, current range) and the current output responds in accordance with the parameter settings in the function FAIL-SAFE MODE (4006). b (- -): The current output signal is proportional to the measured variable assigned. <p style="text-align: right;">A0001274</p> <ul style="list-style-type: none"> ▪ SYMMETRY <p>This option is not available under these circumstances, because the 0_4 mA value and the 20 mA value have different signs.</p> ▪ PULSATING FLOW <p>Flow components outside the measuring range are buffered, balanced and output after a maximum delay of 60 seconds.</p> <p style="text-align: right;">A0001275</p>
<p>TIME CONSTANT (4005)</p>	<p>Use this function to enter a time constant defining how the current output signal reacts to severely fluctuating measured variables, either very quickly (enter a low time constant) or with damping (enter a high time constant).</p> <p>User input: fixed-point number 0.01...100.00 s</p> <p>Factory setting: 1.00 s</p>

Function description	
OUTPUTS → CURRENT OUTPUT (1 to 3) → CONFIGURATION	
FAILSAFE MODE (4006)	<p>For safety reasons it is advisable to ensure that the current output assumes a pre-defined state in the event of a fault. The setting you select here affects only the current output. It has no effect on other outputs and the display (e.g. totalizers).</p> <p>Options:</p> <p>MIN. CURRENT The current output adopts the value of the lower signal on alarm level (as defined in the function CURRENT SPAN (4001), see → 65).</p> <p>MAX. CURRENT The current output adopts the value of the upper signal on alarm level (as defined in the function CURRENT SPAN (4001), see → 65).</p> <p>HOLD VALUE (not recommended) Measuring value output is based on the last measuring value saved before the error occurred .</p> <p>ACTUAL VALUE Measured value output is based on the current flow measurement. The fault is ignored .</p> <p>Factory setting: MIN. CURRENT</p>

7.1.2 Function group OPERATION

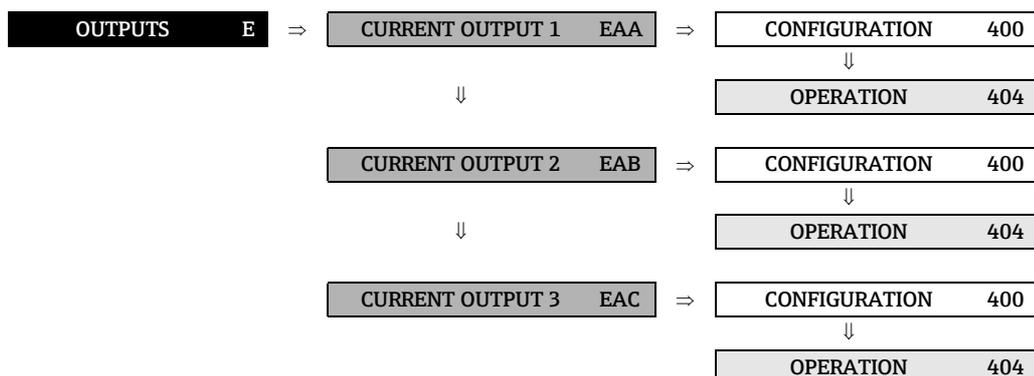

Function description	
OUTPUTS → CURRENT OUTPUT (1 to 3) → OPERATION	
ACTUAL CURRENT (4040)	<p>Use this function to view the computed actual value of the output current.</p> <p>Display: 0.00...25.00 mA</p>
SIMULATION CURRENT (4041)	<p>Use this function to activate simulation of the current output.</p> <p>Options: OFF ON</p> <p>Factory setting: OFF</p> <p> Note! <ul style="list-style-type: none"> ▪ The “SIMULATION CURRENT OUTPUT” message indicates that simulation is active. ▪ The measuring device continues to measure while simulation is in progress, i.e. the current measuring values are output correctly via the other outputs. </p> <p> Caution! The setting is not saved if the power supply fails.</p>
VALUE SIMULATION CURRENT (4042)	<p> Note! The function is not visible unless the function SIMULATION CURRENT (4041) is active (= ON).</p> <p>Use this function to define a freely selectable value (e.g. 12 mA) to be output at the current output. This value is used to test downstream devices and the measuring device itself.</p> <p>User input: 0.00...25.00 mA</p> <p>Factory setting: 0.00 mA</p> <p> Caution! The setting is not saved if the power supply fails.</p>

7.1.3 Function group INFORMATION

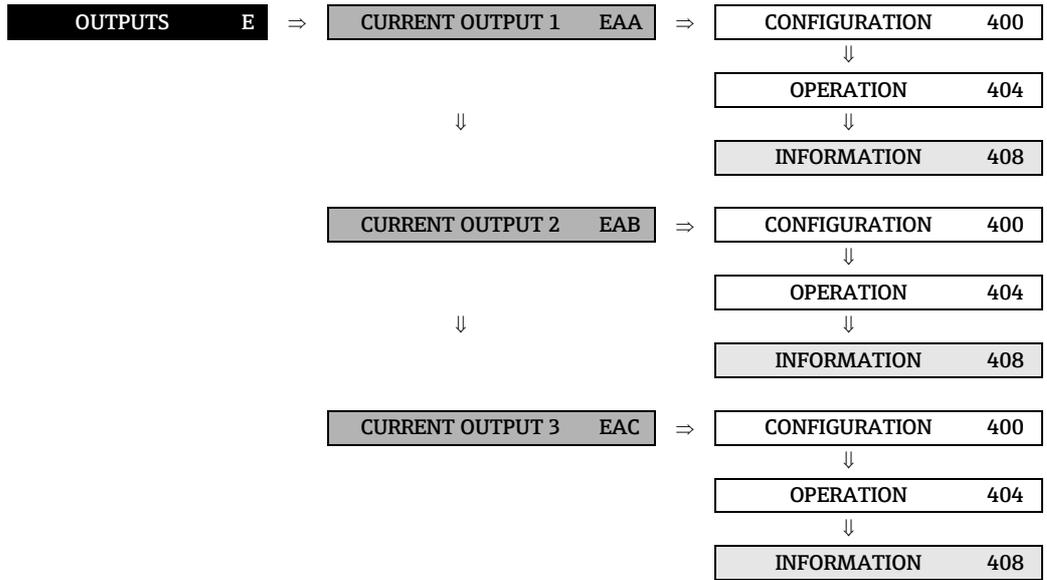

Function description	
OUTPUTS → CURRENT OUTPUT 1 → INFORMATION	
TERMINAL NUMBER (4080)	Use this function to view the numbers of the terminals (in the connection compartment) and the polarity used by the current output.

7.2 Group PULSE/FREQUENCY OUTPUT (1 to 2)

7.2.1 Function group CONFIGURATION

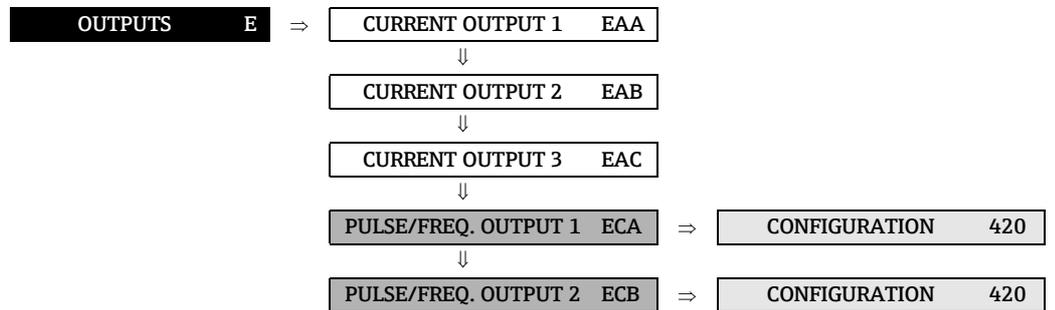

Function description	
OUTPUTS → PULSE/FREQ. OUTP. (1 to 2) → CONFIGURATION (GENERAL)	
OPERATION MODE (4200)	<p>Use this function to configure the output as a pulse, frequency or status output. The functions available in this function group vary, depending on which option you select here.</p> <p>Options: PULSE FREQUENCY STATUS</p> <p>Factory setting: PULSE</p>

Function description	
OUTPUTS → PULSE/FREQUENCY OUTPUT (1 to 2) → CONFIGURATION (FREQUENCY)	
ASSIGN FREQUENCY (4201)	<p> Note! This function is not available unless the FREQUENCY setting was selected in the OPERATION MODE function (4200).</p> <p>Use this function to assign a measured variable to the frequency output.</p> <p>Options: OFF MASS FLOW VOLUME FLOW CORRECTED VOLUME FLOW DENSITY REFERENCE DENSITY TEMPERATURE</p> <p>Advanced options with optional software package CONCENTRATION: TARGET MASS FLOW % TARGET MASS FLOW TARGET VOLUME FLOW % TARGET VOLUME FLOW CORRECTED TARGET VOLUME FLOW CARRIER MASS FLOW % CARRIER MASS FLOW CARRIER VOLUME FLOW % CARRIER VOLUME FLOW CORRECTED CARRIER VOLUME FLOW % BLACK LIQUOR °BAUME °API °PLATO °BALLING °BRIX OTHERS (_ _ _ _ flexible concentration)</p> <p>Advanced options with optional software package ADVANCED DIAGNOSIS: MASS FLOW DEVIATION DENSITY DEVIATION REFERENCE DENSITY DEVIATION TEMPERATURE DEVIATION TUBE DAMPING DEVIATION ELECTRODYNAMIC SENSOR DEVIATION OPERATING FREQUENCY FLUCTUATION DEVIATION TUBE DAMPING FLUCTUATION DEVIATION</p> <p>Factory setting: MASS FLOW</p> <p> Note! If you select OFF, the only function shown in the CONFIGURATION function group is this function, in other words ASSIGN FREQUENCY (4201).</p>

Function description	
OUTPUTS → PULSE/FREQUENCY OUTPUT (1 to 2) → CONFIGURATION (FREQUENCY)	
START VALUE FREQUENCY (4202)	<p> Note! This function is not available unless the FREQUENCY setting was selected in the OPERATION MODE function (4200).</p> <p>Use this function to define an initial frequency for the frequency output. You define the associated measured value of the measuring range in the VALUE F LOW function (4204) described on →  78.</p> <p>User input: 5-digit fixed-point number: 0...10000 Hz</p> <p>Factory setting: 0 Hz</p> <p>Example:</p> <ul style="list-style-type: none"> ■ VALUE F LOW = 0 kg/h, initial frequency = 0 Hz: i.e. a frequency of 0 Hz is output at a flow of 0 kg/h. ■ VALUE F LOW = 1 kg/h, initial frequency = 10 Hz: i.e. a frequency of 10 Hz is output at a flow of 1 kg/h.
END VALUE FREQUENCY (4203)	<p> Note! This function is not available unless the FREQUENCY setting was selected in the OPERATION MODE function (4200).</p> <p>Use this function to define a full scale frequency for the frequency output. You define the associated measured value of the measuring range in the VALUE F HIGH function (4205) described on →  78.</p> <p>User input: 5-digit fixed-point number 2...10000 Hz</p> <p>Factory setting: 10000 Hz</p> <p>Example:</p> <ul style="list-style-type: none"> ■ VALUE F HIGH = 10000 kg/h, full scale frequency = 10000 Hz: i.e. a frequency of 10000 Hz is output at a flow of 10000 kg/h. ■ VALUE F HIGH = 3600 kg/h, full scale frequency = 10000 Hz: i.e. a frequency of 10000 Hz is output at a flow of 3600 kg/h. <p> Note! In the FREQUENCY operating mode the output signal is symmetrical (on/off ratio = 1:1). At low frequencies the pulse duration is limited to a maximum of 2 seconds, i.e. the on/off ratio is no longer symmetrical.</p>

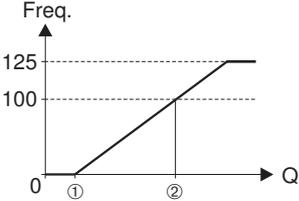
Function description	
OUTPUTS → PULSE/FREQUENCY OUTPUT (1 to 2) → CONFIGURATION (FREQUENCY)	
<p>VALUE F LOW (4204)</p>	<p> Note! This function is not available unless the FREQUENCY setting was selected in the OPERATION MODE function (4200).</p> <p>Use this function to assign a variable to the start value frequency (4202). The value can be higher or lower than the value assigned to the VALUE F HIGH. Positive and negative values are permissible, depending on the measured variable in question (e.g. mass flow). You define a measuring range by defining the VALUE F LOW and VALUE F HIGH values.</p> <p>User input: 5-digit floating-point number</p> <p>Factory setting: 0 [kg/h] or 0 [kg/l] or -50 [°C]</p> <p> Note!</p> <ul style="list-style-type: none"> ▪ For a graphic illustration VALUE F LOW see the VALUE F HIGH function (4205). ▪ Note that values with different signs cannot be entered for VALUE F LOW and VALUE F HIGH, if SYMMETRY is the setting selected for the MEASURING MODE function (4206). In this case, the message "INPUT RANGE EXCEEDED" appears on the display. ▪ The appropriate unit is taken from the UNIT MASS FLOW (0400), UNIT VOLUME FLOW (0402), UNIT CORRECTED VOLUME FLOW (0404), UNIT DENSITY (0420), UNIT REFERENCE DENSITY (0421) or UNIT TEMPERATURE (0422) function (see →  17 to →  21).
<p>VALUE F HIGH (4205)</p>	<p> Note! This function is not available unless the FREQUENCY setting was selected in the OPERATION MODE function (4200).</p> <p>Use this function to assign a variable to the end value frequency (4203). The value can be higher or lower than the value assigned to the VALUE F LOW. Positive and negative values are permissible, depending on the measured variable in question (e.g. mass flow). You define a measuring range by defining the VALUE F LOW and VALUE F HIGH values.</p> <p>User input: 5-digit floating-point number</p> <p>Factory setting: Depends on nominal diameter [kg/h] or 2 [kg/l] or 200 [°C]</p> <p> Note! Note that values with different signs cannot be entered for VALUE F LOW and VALUE F HIGH, if SYMMETRY is the setting selected for the MEASURING MODE function (4206). In this case, the message "INPUT RANGE EXCEEDED" appears on the display.</p> <div style="text-align: center;">  </div> <p>① = VALUE f min ② = VALUE f max</p> <p>(continued on next page)</p>

A0001279

Function description

OUTPUTS → PULSE/FREQUENCY OUTPUT (1 to 2) → CONFIGURATION (FREQUENCY)

VALUE F HIGH
(continued)**Parameter setting example 1:**

1. VALUE F LOW (4204) = not equal to zero flow (e.g. -5 kg/h)
VALUE F HIGH (4205) = not equal to zero flow (e.g. 10 kg/h) or
 2. VALUE F LOW (4204) = not equal to zero flow (e.g. 100 kg/h)
VALUE F HIGH (4205) = not equal to zero flow (e.g. -40 kg/h)
- and MEASURING MODE (4004) = STANDARD

When you enter the values for VALUE F LOW and VALUE F HIGH the working range of the measuring device is defined. If the effective flow drops below or exceeds this working range (see Fig. ①), a fault/notice message is generated (#355-358, frequency area) and the frequency output responds in accordance with the parameters set in the function FAILSAFE MODE (4209).

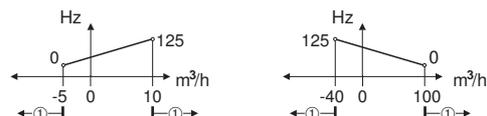

A0001276

Parameter setting example 2:

1. VALUE F LOW (4204) = not equal to zero flow (e.g. 0 kg/h)
VALUE F HIGH (4205) = not equal to zero flow (e.g. 10 kg/h) or
 2. VALUE F LOW (4204) = not equal to zero flow (e.g. 100 kg/h)
VALUE F HIGH (4205) = not equal to zero flow (e.g. 0 kg/h)
- and MEASURING MODE (4004) = STANDARD

When you enter the values for VALUE F LOW and VALUE F HIGH the working range of the measuring device is defined. In doing so, one of the two values is configured as zero flow (e.g. 0 kg/h).

If the effective flow drops below or exceeds the value configured as the zero flow, no fault/notice message is generated and the frequency output retains its value. If the effective flow drops below or exceeds the other value, a fault/notice message is generated (#355-358, frequency area) and the frequency output responds in accordance with the parameters set in the function FAILSAFE MODE (4209).

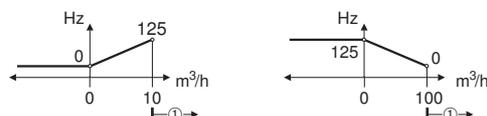

A0001277

Deliberately only one flow direction is output with this setting and flow values in the other flow direction are suppressed.

Parameter setting example 3:

MEASURING MODE (4206) = SYMMETRY

The frequency output signal is independent of the direction of flow (absolute amount of the measured variable). The VALUE F LOW ① and VALUE F HIGH ② must have the same sign (+ or -). The "VALUE F HIGH" ③ (e.g. backflow) corresponds to the mirrored VALUE F HIGH ② (e.g. flow).

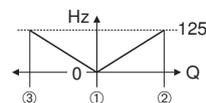

A0001278

ASSIGN RELAY (4700) = FLOW DIRECTION

With this setting e.g. the flow direction output via a switching contact can be made.

Parameter setting example 4:

MEASURING MODE (4004) = PULSATING FLOW → 69

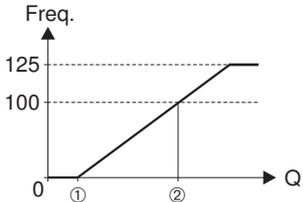
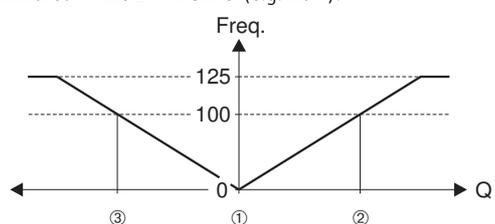
Function description	
OUTPUTS → PULSE/FREQUENCY OUTPUT (1 to 2) → CONFIGURATION (FREQUENCY)	
<p>MEASURING MODE (4206)</p>	<p> Note! This function is not available unless the FREQUENCY setting was selected in the OPERATION MODE function (4200).</p> <p>Use this function to define the measuring mode for the frequency output.</p> <p>Options: STANDARD SYMMETRY PULSATING FLOW</p> <p>Factory setting: STANDARD</p> <p>Description of the individual options:</p> <ul style="list-style-type: none"> ▪ STANDARD The frequency output signal is proportional to the measured variable. The flow components outside the scaled measuring range (defined by the VALUE F LOW ① and the VALUE F HIGH ②) are not taken into account for signal output. <ul style="list-style-type: none"> - If one of the values is defined as equal to the zero flow (e.g. VALUE F LOW = 0 kg/h), no message is given if this value is exceeded or not achieved and the frequency output retains its value (0 Hz in the example). If the other value is exceeded or not achieved, the message "FREQUENCY OUTPUT AT FULL SCALE VALUE" appears and the frequency output responds in accordance with the parameter setting in the function FAILSAFE MODE (4209). - If both values defined are not equal to the zero flow (for example VALUE F LOW = -5 kg/h; VALUE F HIGH = 10 kg/h), the message "FREQUENCY OUTPUT AT FULL SCALE VALUE" appears if the measuring range is exceeded or not achieved and the frequency output responds in accordance with the parameter settings in the function FAILSAFE MODE (4209)... <div style="text-align: center;">  </div> <p style="text-align: right; font-size: small;">A0001279</p> <p>SYMMETRY The frequency output signal is independent of the direction of flow (absolute amount of the measured variable). The VALUE F LOW ① and VALUE F HIGH ② must have the same sign (+ or -). The VALUE F HIGH ③ (e.g. backflow) corresponds to the mirrored VALUE F HIGH ② (e.g. flow).</p> <div style="text-align: center;">  </div> <p style="text-align: right; font-size: small;">A0001280</p> <p> Note!</p> <ul style="list-style-type: none"> ▪ The direction of flow can be output via the configurable relay or status outputs. ▪ SYMMETRY cannot be selected unless the values in the VALUE F LOW (4204) and VALUE F HIGH (4205) functions have the same sign or one of the values is zero. If the values have different signs, SYMMETRY cannot be selected and an "ASSIGNMENT NOT POSSIBLE" message is displayed. <p>(continued on next page)</p>

Function description	
OUTPUTS → PULSE/FREQUENCY OUTPUT (1 to 2) → CONFIGURATION (FREQUENCY)	
MEASURING MODE (continued)	<ul style="list-style-type: none">■ PULSATING FLOW If flow is characterized by severe fluctuations as is the case, for example, with reciprocating pumps, flow components outside the measuring range are buffered, balanced and output after a maximum delay of 60 seconds. If the buffered data cannot be processed within approx. 60 seconds, a fault/notice message appears. Under certain plant conditions, flow values can aggregate in the buffer, for example in the case of prolonged and unwanted fluid backflow. However, this buffer is reset in all relevant programming adjustments which affect the frequency output.

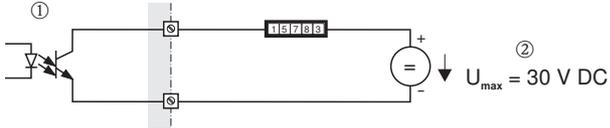
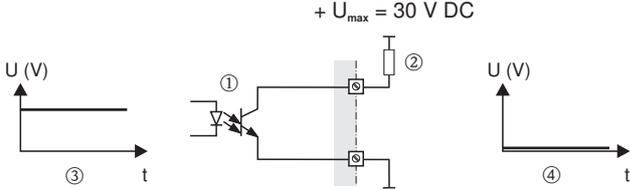
Function description	
OUTPUTS → PULSE/FREQUENCY OUTPUT (1 to 2) → CONFIGURATION (FREQUENCY)	
<p>OUTPUT SIGNAL (4207)</p>	<p> Note! Function is not available unless the FREQUENCY setting was selected in the function.</p> <p>For selecting the output configuration of the frequency output.</p> <p>Options: 0 = PASSIVE - POSITIVE 1 = PASSIVE - NEGATIVE 2 = ACTIVE - POSITIVE 3 = ACTIVE - NEGATIVE</p> <p>Factory setting: PASSIVE - POSITIVE</p> <p>Explanation</p> <ul style="list-style-type: none"> ■ PASSIVE = power is supplied to the frequency output by means of an external power supply. ■ ACTIVE = power is supplied to the frequency output by means of the device-internal power supply. <p>Configuring the output signal level (POSITIVE or NEGATIVE) determines the quiescent behavior (at zero flow) of the frequency output. The internal transistor is activated as follows:</p> <ul style="list-style-type: none"> ■ If POSITIVE is selected, the internal transistor is activated with a positive signal level. ■ If NEGATIVE is selected, the internal transistor is activated with a negative signal level (0 V). <p> Note! With the passive output configuration, the output signal levels of the frequency output depend on the external circuit (see examples).</p> <p>Example for passive output circuit (PASSIVE) If PASSIVE is selected, the frequency output is configured as an open collector.</p>  <p style="text-align: right;">A0001225</p> <p>① = Open collector ② = External power supply</p> <p> Note! For continuous currents up to 25 mA ($I_{max} = 250 \text{ mA} / 20 \text{ ms}$).</p> <p>Example for output configuration PASSIVE-POSITIVE: Output configuration with an external pull-up resistance. In the quiescent state (at zero flow), the output signal level at the terminals is 0 V.</p> <p style="text-align: center;">+ $U_{max} = 30 \text{ V DC}$</p>  <p style="text-align: right;">A0004687</p> <p>① = Open collector ② = Pull-Up-Resistance ③ = Transistor activation in "POSITIVE" quiescent state (at zero flow) ④ = Output signal level in quiescent state (at zero flow)</p>
(continued on next page)	

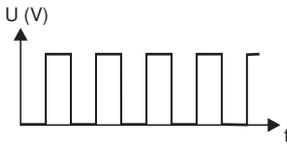
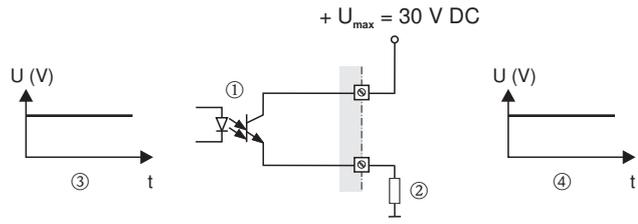
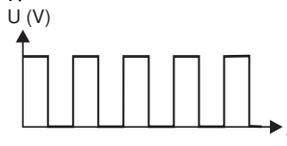
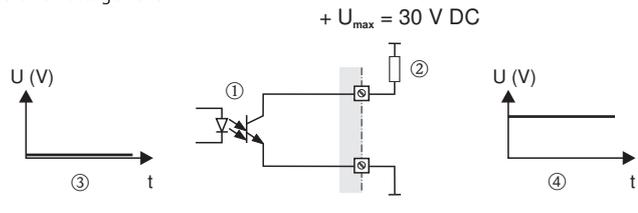
Function description	
OUTPUTS → PULSE/FREQUENCY OUTPUT (1 to 2) → CONFIGURATION (FREQUENCY)	
OUTPUT SIGNAL (continued)	<p>In the operating status (flow present), the output signal level changes from 0 V to a positive voltage level.</p>  <p style="text-align: right;">A0001975</p> <p>Example for output configuration PASSIVE-POSITIVE: Output configuration with an external pull-down resistance. In the quiescent state (at zero flow), a positive voltage level is measured via the pull-down resistance.</p>  <p style="text-align: right;">A0004689</p> <p>① = Open collector ② = Pull-Down-Resistance ③ = Transistor activation in "POSITIVE" quiescent state (at zero flow) ④ = Output signal level in quiescent state (at zero flow)</p> <p>In the operating status (flow present), the output signal level changes from a positive voltage level to 0 V.</p>  <p style="text-align: right;">A0001981</p> <p>Example for output configuration PASSIVE-NEGATIVE: Output configuration with an external pull-up resistance. In the quiescent state (at zero flow), the output signal level at the terminals is at a positive voltage level.</p>  <p style="text-align: right;">A0004690</p> <p>① = Open collector ② = Pull-Up-Resistance ③ = Transistor activation in "NEGATIVE" quiescent state (at zero flow) ④ = Output signal level in quiescent state (at zero flow)</p> <p>In the operating status (flow present), the output signal level changes from a positive voltage level to 0 V.</p>  <p style="text-align: right;">A0001981</p> <p>(continued on next page)</p>

Function description	
OUTPUTS → PULSE/FREQUENCY OUTPUT (1 to 2) → CONFIGURATION (FREQUENCY)	
<p>OUTPUT SIGNAL (continued)</p>	<p>Example for active output circuit (ACTIVE): With an active circuit, the internal power supply is 24 V. The frequency output is short-circuit proof.</p> <div style="text-align: center;"> </div> <p style="text-align: right;">A0004691</p> <p>① = 24 V DC internal power supply ② = Short-circuit proof output</p> <p>The signal levels are to be seen as analogous to the passive circuit.</p> <p>The following applies for the output configuration ACTIVE-POSITIVE: In the quiescent state (at zero flow), the output signal level at the terminals is 0 V.</p> <div style="text-align: center;"> </div> <p style="text-align: right;">A0004694</p> <p>In the operating status (flow present), the output signal level changes from 0 V to a positive voltage level.</p> <div style="text-align: center;"> </div> <p style="text-align: right;">A0004692</p> <p>The following applies for the output configuration ACTIVE-NEGATIVE: In the quiescent state (at zero flow), the output signal level at the terminals is at a positive voltage level.</p> <div style="text-align: center;"> </div> <p style="text-align: right;">A0004693</p> <p>In the operating status (flow present), the output signal level changes from a positive voltage level to 0 V.</p> <div style="text-align: center;"> </div> <p style="text-align: right;">A0004710</p>

Function description	
OUTPUTS → PULSE/FREQUENCY OUTPUT (1 to 2) → CONFIGURATION (FREQUENCY)	
TIME CONSTANT (4208)	<p> Note! This function is not available unless the FREQUENCY setting was selected in the OPERATION MODE function (4200).</p> <p>Use this function to enter a time constant defining how the frequency output signal reacts to severely fluctuating measured variables, either very quickly (enter a low time constant) or with damping (enter a high time constant).</p> <p>User input: Fixed-point number 0.00...100.00 s</p> <p>Factory setting: 0.00 s</p>
FAILSAFE MODE (4209)	<p> Note! This function is not available unless the FREQUENCY setting was selected in the OPERATION MODE function (4200).</p> <p>For safety reasons it is advisable to ensure that the frequency output assumes a predefined state in the event of a fault. The setting you select here affects only the frequency output. It has no effect on other outputs and the display (e.g. totalizers).</p> <p>Options:</p> <p>FALLBACK VALUE Output is 0 Hz.</p> <p>FAILSAFE VALUE Output is the frequency specified in the FAILSAFE VALUE function (4211).</p> <p>HOLD VALUE Measured value output is based on the last measured value saved before the error occurred.</p> <p>ACTUAL VALUE Measured value output is based on the current flow measurement. The fault is ignored .</p> <p>Factory setting: FALLBACK VALUE</p>
FAILSAFE VALUE (4211)	<p> Note! This function is not available unless FREQUENCY was selected in the OPERATION MODE function (4200) and FAILSAFE VALUE was selected in the FAILSAFE MODE function (4209).</p> <p>Use this function to define the frequency that the measuring device outputs in the event of an error.</p> <p>User input: max. 5-digit number: 0...12500 Hz</p> <p>Factory setting: 12500 Hz</p>

Function description	
OUTPUTS → PULSE/FREQUENCY OUTPUT (1 to 2) → CONFIGURATION (PULSE)	
<p>ASSIGN PULSE (4221)</p>	<p> Note! This function is not available unless the PULSE setting was selected in the OPERATION MODE function (4200).</p> <p>Use this function to assign a measured variable to the pulse output.</p> <p>Options: OFF MASS FLOW VOLUME FLOW CORRECTED VOLUME FLOW</p> <p>Advanced options with optional software package CONCENTRATION: TARGET MASS TARGET VOLUME TARGET CORRECTED VOLUME CARRIER MASS CARRIER VOLUME CARRIER CORRECTED VOLUME</p> <p>Factory setting: MASS FLOW</p> <p> Note! If you select OFF, the only function shown in the CONFIGURATION function group is this function, in other words ASSIGN PULSE (4221).</p>
<p>PULSE VALUE (4222)</p>	<p> Note! This function is not available unless the PULSE setting was selected in the OPERATION MODE function (4200).</p> <p>Use this function to define the flow at which a pulse is triggered. These pulses can be totaled by an external totalizer, and the total flow quantity since measuring started can be registered in this way.</p> <p>User input: 5-digit floating-point number [unit]</p> <p>Factory setting: depends on nominal diameter and country, [value] [kg or lb] / impulse; corresponds to the factory setting for the pulse value (→  187).</p> <p> Note! The appropriate unit is taken from the UNIT MASS (0401), UNIT VOLUME (0403) or UNIT CORRECTED VOLUME (0405) function (see →  17 or →  19).</p>

Function description

OUTPUTS → PULSE/FREQUENCY OUTPUT (1 to 2) → CONFIGURATION (PULSE)

PULSE WIDTH
(4223) Note!

This function is not available unless the PULSE setting was selected in the OPERATION MODE function (4200).

Use this function to enter the pulse width of the output pulse.

User input:

0.05...2000 ms

Factory setting:

100 ms

Pulse output is **always** with the pulse width (B) entered in this function. The pauses (P) between the individual pulses are automatically configured. However, they must at least correspond to the pulse width ($B = P$).

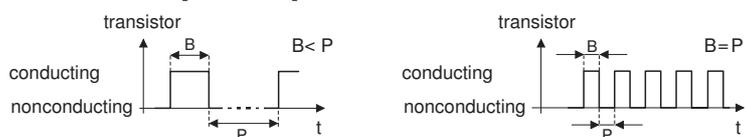

A0001233-en

B = Pulse width entered (the illustration applies to positive pulses)

P = Pauses between the individual pulses

 Note!

When entering the pulse width, select a value that can still be processed by an external totalizer (e.g. mechanical totalizer, PLC, etc.).



Caution!

If the pulse number or frequency resulting from the pulse value entered (see function PULSE VALUE (4222) on → 86) and from the current flow is too large to maintain the pulse width selected (the time interval is smaller than the pulse width B entered), a system error message is generated (# 359...362, pulse buffer) after approx. 5 seconds buffer/balance time.

Function description OUTPUTS → PULSE/FREQUENCY OUTPUT (1 to 2) → CONFIGURATION (PULSE)	
MEASURING MODE (4225)	<p> Note! This function is not available unless the PULSE setting was selected in the OPERATION MODE function (4200).</p> <p>Use this function to define the measuring mode for the pulse output.</p> <p>Options:</p> <p>STANDARD Only positive flow components are totaled. Negative components are not taken into account.</p> <p>SYMMETRY Positive and negative flow components are taken into account.</p> <p> Note! The direction of flow can be output via the relay output.</p> <p>PULSATING FLOW If flow is characterized by severe fluctuations as is the case, for example, with reciprocating pumps, the positive and negative flow components are totaled, with the signs taken into account (e.g. -10 l and +25 l = 15 l).</p> <p>Flow components outside the maximum pulse number per second (value/width) are buffered, balanced and output after a maximum delay of 60 seconds. If the buffered data cannot be processed within approx. 60 seconds, a fault/notice message appears.</p> <p>Under certain plant conditions, flow values can aggregate in the buffer, for example in the case of prolonged and unwanted fluid backflow. However, this buffer is reset in all relevant programming adjustments which affect the pulse output.</p> <p>STANDARD REVERSE Only negative flow components are totaled. Positive components are not taken into account.</p> <p>Factory setting: STANDARD</p>

Function description

OUTPUTS → PULSE/FREQUENCY OUTPUT (1 to 2) → CONFIGURATION (PULSE)

OUTPUT SIGNAL
(4226) Note!

Function is not available unless the PULSE setting was selected in the function.

For selecting the output configuration of the pulse output.

Options:

- 0 = PASSIVE - POSITIVE
- 1 = PASSIVE - NEGATIVE
- 2 = ACTIVE - POSITIVE
- 3 = ACTIVE - NEGATIVE

Factory setting: PASSIVE - POSITIVE

Explanation

- PASSIVE = power is supplied to the pulse output by means of an external power supply.
- ACTIVE = power is supplied to the pulse output by means of the device-internal power supply.

Configuring the output signal level (POSITIVE or NEGATIVE) determines the quiescent behavior (at zero flow) of the pulse output.

The internal transistor is activated as follows:

- If POSITIVE is selected, the internal transistor is activated with a **positive** signal level.
- If NEGATIVE is selected, the internal transistor is activated with a **negative** signal level (0 V).

 Note!

With the passive output configuration, the output signal levels of the pulse output depend on the external circuit (see examples).

Example for passive output circuit (PASSIVE)

If PASSIVE is selected, the pulse output is configured as an open collector.

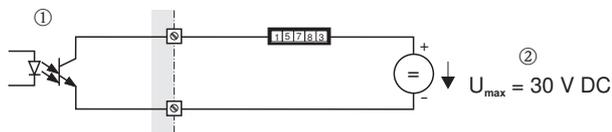

A0001225

① = Open collector

② = External power supply

 Note!For continuous currents up to 25 mA ($I_{\max} = 250 \text{ mA} / 20 \text{ ms}$).**Example for output configuration PASSIVE-POSITIVE:**

Output configuration with an external pull-up resistance.

In the quiescent state (at zero flow), the output signal level at the terminals is 0 V.

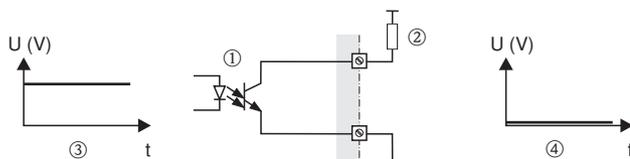
 $+ U_{\max} = 30 \text{ V DC}$ 

A0004687

① = Open collector

② = Pull-Up-Resistance

③ = Transistor activation in "POSITIVE" quiescent state (at zero flow)

④ = Output signal level in quiescent state (at zero flow)

(continued on next page)

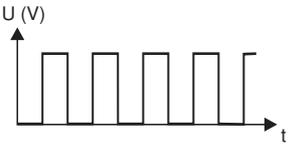
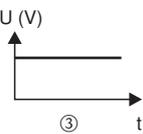
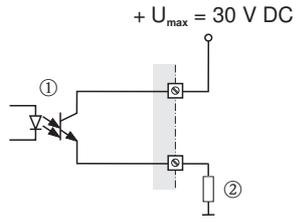
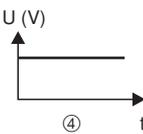
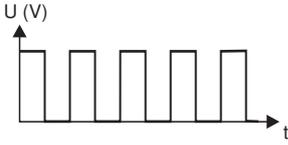
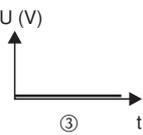
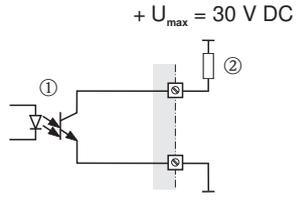
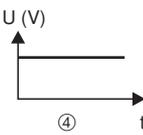
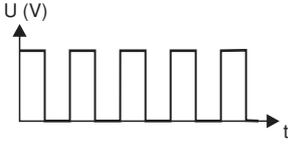
Function description	
OUTPUTS → PULSE/FREQUENCY OUTPUT (1 to 2) → CONFIGURATION (PULSE)	
<p>OUTPUT SIGNAL (continued)</p>	<p>In the operating status (flow present), the output signal level changes from 0 V to a positive voltage level.</p> <div style="text-align: center;">  </div> <p style="text-align: right;">A0001975</p> <p>Example for output configuration PASSIVE-POSITIVE: Output configuration with an external pull-down resistance. In the quiescent state (at zero flow), a positive voltage level is measured via the pull-down resistance.</p> <div style="display: flex; align-items: center; justify-content: center;"> <div style="text-align: center;">  <p>③</p> </div> <div style="text-align: center;">  </div> <div style="text-align: center;">  <p>④</p> </div> </div> <p style="text-align: right;">A0004689</p> <p>① = Open collector ② = Pull-Down-Resistance ③ = Transistor activation in "POSITIVE" quiescent state (at zero flow) ④ = Output signal level in quiescent state (at zero flow)</p> <p>In the operating status (flow present), the output signal level changes from a positive voltage level to 0 V.</p> <div style="text-align: center;">  </div> <p style="text-align: right;">A0001981</p> <p>Example for output configuration PASSIVE-NEGATIVE: Output configuration with an external pull-up resistance. In the quiescent state (at zero flow), the output signal level at the terminals is at a positive voltage level.</p> <div style="display: flex; align-items: center; justify-content: center;"> <div style="text-align: center;">  <p>③</p> </div> <div style="text-align: center;">  </div> <div style="text-align: center;">  <p>④</p> </div> </div> <p style="text-align: right;">A0004690</p> <p>① = Open collector ② = Pull-Up-Resistance ③ = Transistor activation in "NEGATIVE" quiescent state (at zero flow) ④ = Output signal level in quiescent state (at zero flow)</p> <p>In the operating status (flow present), the output signal level changes from a positive voltage level to 0 V.</p> <div style="text-align: center;">  </div> <p style="text-align: right;">A0001981</p> <p>(continued on next page)</p>

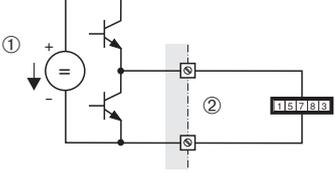
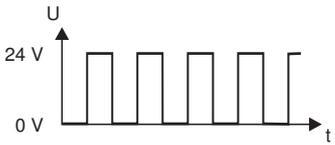
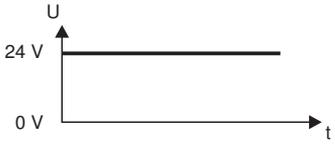
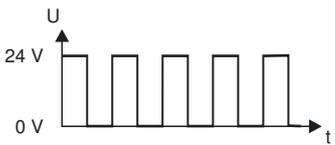
Function description	
OUTPUTS → PULSE/FREQUENCY OUTPUT (1 to 2) → CONFIGURATION (PULSE)	
<p>OUTPUT SIGNAL (continued)</p>	<p>Example for active output circuit (ACTIVE): With an active circuit, the internal power supply is 24 V. The pulse output is short-circuit proof.</p>  <p style="text-align: right;">A0004691</p> <p>① = 24 V DC internal power supply ② = Short-circuit proof output</p> <p>The signal levels are to be seen as analogous to the passive circuit.</p> <p>The following applies for the output configuration ACTIVE-POSITIVE: In the quiescent state (at zero flow), the output signal level at the terminals is 0 V.</p>  <p style="text-align: right;">A0004694</p> <p>In the operating status (flow present), the output signal level changes from 0 V to a positive voltage level.</p>  <p style="text-align: right;">A0004692</p> <p>The following applies for the output configuration ACTIVE-NEGATIVE: In the quiescent state (at zero flow), the output signal level at the terminals is at a positive voltage level.</p>  <p style="text-align: right;">A0004693</p> <p>In the operating status (flow present), the output signal level changes from a positive voltage level to 0 V.</p>  <p style="text-align: right;">A0004710</p>

Function description OUTPUTS → PULSE/FREQUENCY OUTPUT (1 to 2) → CONFIGURATION (PULSE)	
FAILSAFE MODE (4227)	<p> Note! This function is not available unless the PULSE setting was selected in the OPERATION MODE function (4200).</p> <p>For safety reasons it is advisable to ensure that the pulse output assumes a predefined state in the event of a fault. The setting you select here affects only the pulse output. It has no effect on other outputs and the display (e.g. totalizers).</p> <p>Options: FALLBACK VALUE Output is 0 pulse.</p> <p>ACTUAL VALUE Measured value output is based on the current flow measurement. The fault is ignored.</p> <p>Factory setting: FALLBACK VALUE</p>

Function description	
OUTPUTS → PULSE/FREQUENCY OUTPUT (1 to 2) → CONFIGURATION (STATUS)	
ASSIGN STATUS (4241)	<p> Note! This function is not available unless the STATUS setting was selected in the OPERATION MODE function (4200).</p> <p>Use this function to assign a switching function to the status output.</p> <p>Options: OFF ON (operation) FAULT MESSAGE NOTICE MESSAGE FAULT MESSAGE or NOTICE MESSAGE EMPTY PIPE DETECTION (only with active function) FLOW DIRECTION MASS FLOW LIMIT VALUE VOLUME FLOW LIMIT VALUE CORRECTED VOLUME FLOW LIMIT VALUE DENSITY LIMIT VALUE REFERENCE DENSITY LIMIT VALUE TEMPERATURE LIMIT VALUE TOTALIZER 1 LIMIT VALUE TOTALIZER 2 LIMIT VALUE TOTALIZER 3 LIMIT VALUE</p> <p>Advanced options with optional software package BATCHING: BATCH RUNNING > BATCH TIME >< BATCH QUANTITIES (< min. / > max. batching quantity) PROGRESS NOTE (batching end approaching)</p> <p> Note! The only options available are the monitoring functions (7240 to 7243) which have a value not equal to zero (max. 3).</p> <p>Advanced options with optional software package CONCENTRATION: LIMIT TARGET MASS FLOW LIMIT TARGET % MASS PROPORTION FLOW LIMIT TARGET VOLUME FLOW LIMIT TARGET % VOLUME PROPORTION FLOW LIMIT TARGET CORRECTED VOLUME FLOW LIMIT CARRIER MASS FLOW LIMIT CARRIER % MASS PROPORTION FLOW LIMIT CARRIER VOLUME FLOW LIMIT CARRIER % VOLUME PROPORTION FLOW LIMIT CARRIER CORRECTED VOLUME FLOW LIMIT % BLACK LIQUOR LIMIT °BAUME > 1 LIMIT °BAUME < 1 LIMIT °API LIMIT °PLATO LIMIT °BALLING LIMIT °BRX LIMIT OTHERS (_ _ _ _ flexible concentration)</p> <p>Advanced options with optional software package ADVANCED DIAGNOSIS: LIMIT MASS FLOW DEVIATION LIMIT DENSITY DEVIATION LIMIT REFERENCE DENSITY DEVIATION LIMIT TEMPERATURE DEVIATION LIMIT TUBE DAMPING DEVIATION LIMIT ELECTRODYNAMIC SENSOR DEVIATION LIMIT OPERATING FREQUENCY DEVIATION LIMIT TUBE DAMPING DEVIATION</p> <p>(continued on next page)</p>

Function description	
OUTPUTS → PULSE/FREQUENCY OUTPUT (1 to 2) → CONFIGURATION (STATUS)	
ASSIGN STATUS (continued)	<p>Factory setting: FAULT MESSAGE</p> <p> Note!</p> <ul style="list-style-type: none"> ▪ The behavior of the status output is a normally closed behavior, in other words the output is closed (transistor conductive) when normal, error-free measuring is in progress. <ul style="list-style-type: none"> – “normal, error-free” operation: Flow direction = forwards; limit values = not exceeded; no empty or partially filled measuring tube (EPD/OED); no fault or notice message present. – Switching response like relay output, →  111 ▪ If you select OFF, the only function shown in the CONFIGURATION function group is this function, in other words ASSIGN STATUS (4241). ▪ Switching response like relay output, see →  111.
ON-VALUE (4242)	<p> Note!</p> <p>This function is not available unless STATUS was selected in the OPERATION MODE function (4200) and LIMIT VALUE or FLOW DIRECTION was selected in the ASSIGN STATUS function (4241).</p> <p>Use this function to assign a value to the switch-on point (activation of the status output). The value can be higher or lower than the switch-off point. Positive or negative values are permissible, depending on the measured variable in question (e.g. mass flow, totalizer reading).</p> <p>User input: 5-digit floating-point number [unit]</p> <p>Factory setting: 0 [kg/h] or 2 [kg/l] or 200 [°C]</p> <p> Note!</p> <ul style="list-style-type: none"> ▪ If SYMMETRY is selected in the function MEASURING MODE (4246) and values with different signs are entered for the switch-on and switch-off points, the notice message “INPUT RANGE EXCEEDED” appears. ▪ Only the switch-on point is available for flow direction output (no switch-off point). If you enter a value not equal to the zero flow (e.g. 5), the difference between the zero flow and the value entered corresponds to half the switchover hysteresis.
SWITCH-ON DELAY (4243)	<p> Note!</p> <p>This function is not available unless STATUS was selected in the OPERATION MODE function (4200) and LIMIT VALUE or FLOW DIRECTION was selected in the ASSIGN STATUS function (4241).</p> <p>Use this function to define a delay (0...100 seconds) for the switch-on (i.e. signal changes from “not conductive” to “conductive”) of the status output. The delay starts when the limit value is reached. The status output does switch when the delay has timed out and the switch on condition has been valid over the delay time.</p> <p>User input: fixed-point number: 0.0...100.0 s</p> <p>Factory setting: 0.0 s</p>

Function description	
OUTPUTS → PULSE/FREQUENCY OUTPUT (1 to 2) → CONFIGURATION (STATUS)	
OFF-VALUE (4244)	<p> Note! This function is not available unless STATUS was selected in the OPERATION MODE function (4200) and a LIMIT VALUE was selected in the ASSIGN STATUS function (4241).</p> <p>Use this function to assign a value to the switch-off point (deactivation of the status output). The value can be higher or lower than the switch-on point. Positive and negative values are permissible, depending on the measured variable in question (e.g. mass flow, totalizer reading).</p> <p>User input: 5-digit floating-point number [unit]</p> <p>Factory setting: 0 [kg/h] or 2 [kg/l] or 200 [°C]</p> <p> Note!</p> <ul style="list-style-type: none"> ▪ The appropriate unit is taken from the function UNIT VOLUME FLOW (0402) or UNIT MASS FLOW (0400). ▪ If SYMMETRY is selected in the function MEASURING MODE (4246) and values with different signs are entered for the switch-on and switch-off points, the notice message "INPUT RANGE EXCEEDED" appears.
SWITCH-OFF DELAY (4245)	<p> Note! This function is not available unless the STATUS setting was selected in the OPERATION MODE function (4200).</p> <p>Use this function to define a delay (0...100 seconds) for the switch-off (i.e. signal changes from "conductive" to "not conductive") of the status output. The delay starts when the limit value is reached. The status output does switch when the delay has timed out and the switch off condition has been valid over the delay time.</p> <p>User input: fixed-point number: 0.0...100.0 s</p> <p>Factory setting: 0.0 s</p>

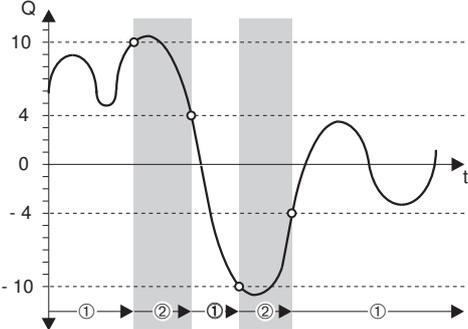
Function description	
OUTPUTS → PULSE/FREQUENCY OUTPUT (1 to 2) → CONFIGURATION (STATUS)	
<p>MEASURING MODE (4246)</p>	<p> Note! This function is not available unless STATUS was selected in the OPERATION MODE function(4200) and the status output was assigned a limit value.</p> <p>Use this function to define the measuring mode for the status output.</p> <p>Options: STANDARD The status output signal switches at the defined switch points.</p> <p>SYMMETRY The status output signal switches at the defined switch points, irrespective of the sign. If you define a switch point with a positive sign, the status output signal switches as soon as the value is reached in the negative direction (negative sign), (see illustration).</p> <p>Factory setting: STANDARD</p> <p>Example for the SYMMETRY measuring mode: Switch-on point Q = 4, Switch-off point Q = 10 ① = Status output switched on (conductive) ② = Status output switched off (nonconductive)</p>  <p style="text-align: right; font-size: small;">A0001247</p> <p> Note!</p> <ul style="list-style-type: none"> ▪ SYMMETRY cannot be selected unless the values in the ON-VALUE (4242) and OFF-VALUE (4244) functions have the same sign or one of the values is zero. ▪ If the values have different signs, SYMMETRY cannot be selected and an “ASSIGNMENT NOT POSSIBLE” message is displayed.
<p>TIME CONSTANT (4247)</p>	<p> Note! This function is not available unless the STATUS setting was selected in the OPERATION MODE function (4200).</p> <p>Use this function to enter a time constant defining how the measuring signal reacts to severely fluctuating measured variables, either very quickly (enter a low time constant) or with damping (enter a high time constant). Damping acts on the measuring signal before the switch status changes, and consequently before switch-on or switch-off delay is activated. The purpose of damping, therefore, is to prevent the status output changing state continuously in response to fluctuations in flow.</p> <p>User input: Fixed-point number 0.00 to 100.00 s</p> <p>Factory setting: 0.00 s</p>

7.2.2 Function group OPERATION

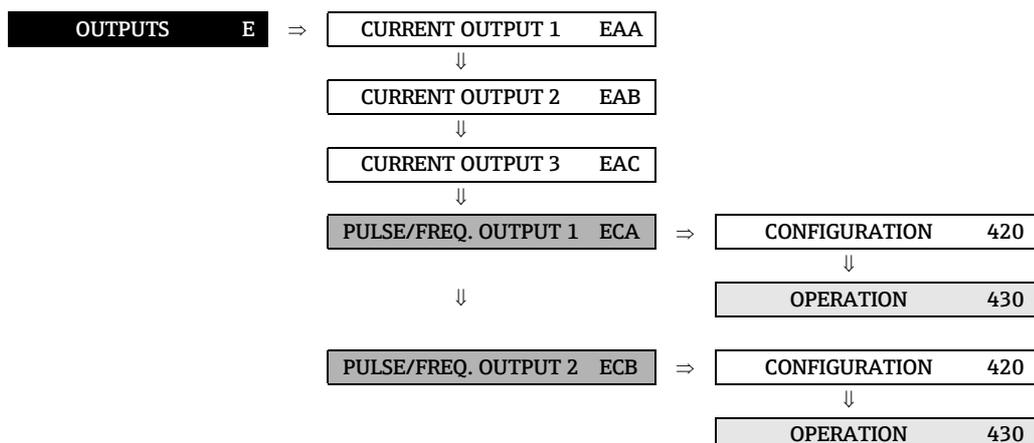

Function description	
OUTPUTS → PULSE/FREQUENCY OUTPUT (1 to 2) → OPERATION (FREQUENCY)	
ACTUAL FREQUENCY (4301)	<p> Note! This function is not available unless the FREQUENCY setting was selected in the OPERATION MODE function (4200).</p> <p>Use this function to view the computed actual value of the output frequency.</p> <p>Display: 0...12500 Hz</p>
SIMULATION FREQUENCY (4302)	<p> Note! This function is not available unless the FREQUENCY setting was selected in the OPERATION MODE function (4200).</p> <p>Use this function to activate simulation of the frequency output.</p> <p>Options: OFF ON</p> <p>Factory setting: OFF</p> <p> Note!</p> <ul style="list-style-type: none"> ▪ The “SIMULATION FREQUENCY OUTPUT” message indicates that simulation is active. ▪ The measuring device continues to measure while simulation is in progress, i.e. the current measured values are output correctly via the other outputs. <p> Caution! The setting is not saved if the power supply fails.</p>

Function description	
OUTPUTS → PULSE/FREQUENCY OUTPUT (1 to 2) → OPERATION (FREQUENCY)	
VALUE SIMULATION FREQUENCY (4303)	<p> Note! This function is not available unless FREQUENCY was selected in the OPERATION MODE function (4200) and the SIMULATION FREQUENCY function (4302) is active (= ON).</p> <p>Use this function to define a free selectable frequency value (e.g. 500 Hz) which should be output at the frequency output (with maximum pulse frequency or shortened minimum pulse width). This value is used to test downstream devices and the measuring device itself.</p> <p>User input: 0...12500 Hz</p> <p>Factory setting: 0 Hz</p> <p> Caution! The setting is not saved if the power supply fails.</p>

Function description	
OUTPUTS → PULSE/FREQUENCY OUTPUT (1...2) → OPERATION (PULSE)	
SIMULATION PULSE(4322)	<p> Note! This function is not available unless the PULSE option was selected in the OPERATION MODE function.</p> <p>Use this function to activate simulation of the pulse output.</p> <p>Options: OFF COUNTDOWN The pulses specified in the VALUE SIMULATION PULSE function are output.</p> <p>CONTINUOUSLY Pulses are continuously output with the pulse width specified in the PULSE WIDTH function. Simulation is started once the CONTINUOUSLY option is confirmed with the  key.</p> <p> Note! Simulation is started by confirming the CONTINUOUSLY option with the  key. The simulation can be switched off again via the SIMULATION PULSE function.</p> <p>Factory setting: OFF</p> <p> Note!</p> <ul style="list-style-type: none"> ▪ The notice message #631 “SIM. PULSE” indicates that simulation is active. ▪ The on/off ratio is 1:1 for both types of simulation. ▪ The measuring device continues to measure while simulation is in progress, i.e. the current measured values are output correctly via the other outputs. <p> Caution! The setting is not saved if the power supply fails.</p>

Function description	
OUTPUTS → PULSE/FREQUENCY OUTPUT (1...2) → OPERATION (PULSE)	
VALUE SIMULATION PULSE (4323)	<p> Note! This function is not available unless the COUNTDOWN option was selected in the SIMULATION PULSE function.</p> <p>Use this function to specify the number of pulses (e.g. 50) which are output during the simulation. This value is used to test downstream devices and the measuring device itself. The pulses are output with the pulse width specified in the PULSE WIDTH function. The on/off ratio is 1:1.</p> <p>Simulation is started once the specified value is confirmed with the  key. The display remains at 0 if the specified pulses have been output.</p> <p>User input: 0...10 000</p> <p>Factory setting: 0</p> <p> Note! Simulation is started by confirming the simulation value with the  key. The simulation can be switched off again via the SIMULATION PULSE function.</p> <p> Caution! The setting is not saved if the power supply fails.</p>

Function description	
OUTPUTS → PULSE/FREQUENCY OUTPUT (1 to 2) → OPERATION (STATUS)	
ACTUAL STATUS (4341)	<p> Note! This function is not available unless the STATUS setting was selected in the OPERATION MODE function (4200).</p> <p>Use this function to check the current status of the status output.</p> <p>Display: NOT CONDUCTIVE CONDUCTIVE</p>
SIMULATION SWITCH POINT (4342)	<p> Note! This function is not available unless the STATUS setting was selected in the OPERATION MODE function (4200).</p> <p>Use this function to activate simulation of the status output.</p> <p>Options: OFF ON</p> <p>Factory setting: OFF</p> <p> Note!</p> <ul style="list-style-type: none"> ▪ The “SIMULATION STATUS OUTPUT” message indicates that simulation is active. ▪ The measuring device continues to measure while simulation is in progress, i.e. the current measured values are output correctly via the other outputs. <p> Caution! The setting is not saved if the power supply fails.</p>

Function description	
OUTPUTS → PULSE/FREQUENCY OUTPUT (1 to 2) → OPERATION (STATUS)	
VALUE SIMULATION SWITCH POINT (4343)	<p> Note! This function is not available unless STATUS was selected in the OPERATION MODE function (4200) and the SIMULATION SWITCH POINT function (4342) is active (= ON).</p> <p>Use this function to define the switching response of the status output during the simulation. This value is used to test downstream devices and the measuring device itself.</p> <p>Options: NOT CONDUCTIVE CONDUCTIVE</p> <p>Factory setting: NOT CONDUCTIVE</p> <p> Caution! The setting is not saved if the power supply fails.</p>

7.2.3 Function group INFORMATION

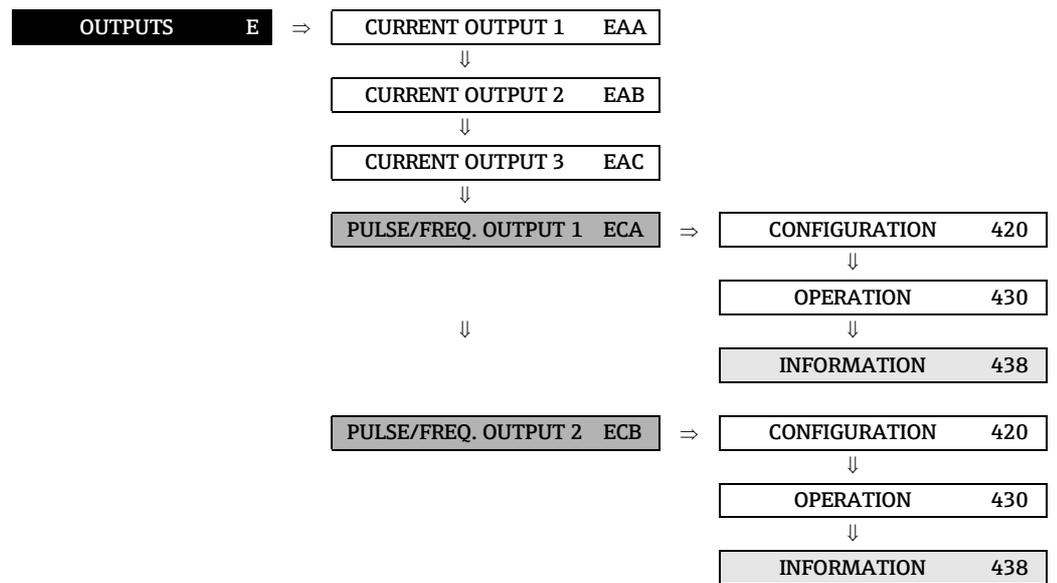

Function description	
OUTPUTS → PULSE/FREQ. OUTP. (1 to 2) → INFORMATION	
TERMINAL NUMBER (4380)	Use this function to view the numbers of the terminals (in the connection compartment) and the polarity used by the pulse/frequency output.

7.3 Group RELAY OUTPUT (1 to 2)

7.3.1 Function group CONFIGURATION

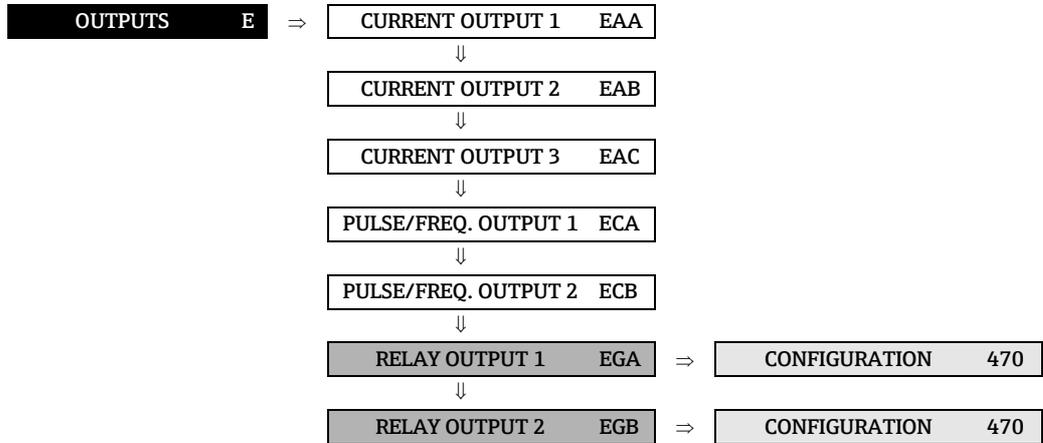

Function description	
OUTPUTS → RELAY OUTPUT (1 to 2) → CONFIGURATION	
ASSIGN RELAY (4700)	<p>Use this function to assign a switching function to the relay output.</p> <p>Options (standard): OFF ON (operation) FAULT MESSAGE NOTICE MESSAGE FAULT MESSAGE or NOTICE MESSAGE EPD (Empty pipe detection, only if active) FLOW DIRECTION LIMIT MASS FLOW LIMIT VOLUME FLOW LIMIT CORRECTED VOLUME FLOW LIMIT DENSITY LIMIT REFERENCE DENSITY LIMIT TEMPERATURE LIMIT TOTALIZER 1...3</p> <p>Advanced options with optional software package BATCHING: BATCH VALVE 1 (e.g. to control valve 1) BATCH VALVE 2 (e.g. to control valve 2) BATCH RUNNING > BATCH TIME >> BATCH QUANTITIES (< min. / > max. batching quantity) PROGRESS NOTE (batching end approaching)</p> <p> Note!</p> <ul style="list-style-type: none"> ▪ The batching valves defined in the function BATCH STAGES (7208) are the only available selection (max. 3). ▪ The only options available are the monitoring functions (7240 to 7243) which have a value not equal to zero (max. 3). <p style="text-align: right;">(continued on next page)</p>

Function description	
OUTPUTS → RELAY OUTPUT (1 to 2) → CONFIGURATION	
ASSIGN RELAY (continued)	<p>Advanced options with optional software package CONCENTRATION:</p> <p>LIMIT TARGET MASS FLOW LIMIT TARGET % MASS PROPORTION FLOW LIMIT TARGET VOLUME FLOW LIMIT TARGET % VOLUME PROPORTION FLOW LIMIT TARGET CORRECTED VOLUME FLOW LIMIT CARRIER MASS FLOW LIMIT CARRIER % MASS PROPORTION FLOW LIMIT CARRIER VOLUME FLOW LIMIT CARRIER % VOLUME PROPORTION FLOW LIMIT CARRIER CORRECTED VOLUME FLOW LIMIT % BLACK LIQUOR LIMIT °BAUME > 1 LIMIT °BAUME < 1 LIMIT °API LIMIT °PLATO LIMIT °BALLING LIMIT °BRIX LIMIT OTHERS (_ _ _ _ flexible concentration)</p> <p>Advanced options with opt. software package ADVANCED DIAGNOSIS:</p> <p>LIMIT MASS FLOW DEVIATION LIMIT DENSITY DEVIATION LIMIT REFERENCE DENSITY DEVIATION LIMIT TEMPERATURE DEVIATION LIMIT TUBE DAMPING DEVIATION LIMIT ELECTRODYNAMIC SENSOR DEVIATION LIMIT OPERATING FREQUENCY DEVIATION LIMIT TUBE DAMPING DEVIATION</p> <p>Factory setting: FAULT MESSAGE</p> <p> Note!</p> <ul style="list-style-type: none"> ▪ It is very important to read and comply with the information on the switching characteristics of the relay output, (see →  111). ▪ It is advisable to configure at least one relay output as a fault output and define the outputs' failsafe mode. ▪ The relay output is configured as a normally open (NO or make) contact by default. It can be reconfigured as a normally closed (NC or break) contact by means of a jumper on the relay module (see Operating Instructions <i>Proline Pro-mass 83</i>, BA 059D/06/en). ▪ If you select OFF or ON, the only function shown in the CONFIGURATION function group is this function ASSIGN RELAY (4700).

Function description OUTPUTS → RELAY OUTPUT (1 to 2) → CONFIGURATION	
ON VALUE (4701)	<p> Note! This function is not available unless LIMIT VALUE or FLOW DIRECTION was selected in the ASSIGN RELAY function (4700).</p> <p>Use this function to assign a value to the switch-on point (relay output pulls up). The value can be higher or lower than the switch-off point. Positive or negative values are permissible, depending on the measured variable in question (e.g. mass flow, totalizer reading).</p> <p>User input: 5-digit floating-point number [unit]</p> <p>Factory setting: 0 [kg/h] or 2 [kg/l] or 200 [°C]</p> <p> Note!</p> <ul style="list-style-type: none"> ▪ The appropriate unit is taken from the function UNIT VOLUME FLOW (0402) or UNIT MASS FLOW (0400). ▪ Only the switch-on point is available for flow direction output (no switch-off point). If you enter a value not equal to the zero flow (e.g. 5), the difference between the zero flow and the value entered corresponds to half the switchover hysteresis.
SWITCH-ON DELAY (4702)	<p> Note! This function is not available unless LIMIT VALUE or FLOW DIRECTION was selected in the ASSIGN RELAY function (4700).</p> <p>Use this function to define a delay (0 ... 100 seconds) for pull-up (i.e. signal changes from 0 to 1) of the relay output. The delay starts when the limit value is reached. The relay output does switch when the delay has timed out and the switch on condition has been valid over the delay time.</p> <p>User input: fixed-point number 0.0...100.0 s</p> <p>Factory setting: 0.0 s</p>
OFF-VALUE (4703)	<p> Note! This function is not available unless LIMIT VALUE was selected in the ASSIGN RELAY function (4700).</p> <p>Use this function to assign a value to the switch-off point (relay drops out). The value can be higher or lower than the switch-on point. Positive or negative values are permissible, depending on the measured variable in question (e.g. mass flow, totalizer reading).</p> <p>User input: 5-digit floating-point number [unit]</p> <p>Factory setting: 0 [kg/h] or 2 [kg/l] or 200 [°C]</p> <p> Note!</p> <ul style="list-style-type: none"> ▪ The appropriate unit is taken from the function UNIT VOLUME FLOW (0402) or UNIT MASS FLOW (0400). ▪ If SYMMETRY is selected in the function MEASURING MODE (4705) and values with different signs are entered for the switch-on and switch-off points, the notice message "INPUT RANGE EXCEEDED" appears.

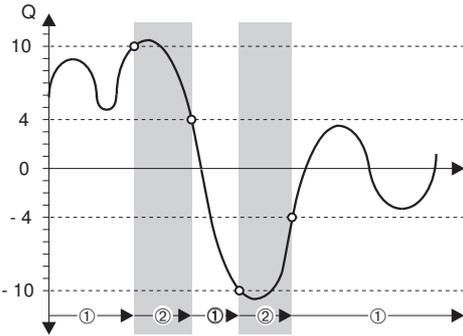
Function description	
OUTPUTS → RELAY OUTPUT (1 to 2) → CONFIGURATION	
SWITCH-OFF DELAY (4704)	<p> Note! This function is not available unless LIMIT VALUE was selected in the ASSIGN RELAY function (4700).</p> <p>Use this function to define a delay (0 ... 100 seconds) for dropout (i.e. signal changes from 1 to 0) of the relay output. The delay starts when the limit value is reached. The relay output does switch when the delay has timed out and the switch off condition has been valid over the delay time.</p> <p>User input: fixed-point number 0.0...100.0 s</p> <p>Factory setting: 0.0 s</p>
MEASURING MODE (4705)	<p> Note! This function is not visible unless a limit value was assigned to the relay output.</p> <p>Use this function to define the measuring mode for the relay output.</p> <p>Options: STANDARD The relay output signal switches at the defined switch points.</p> <p>SYMMETRY The relay output signal switches at the defined switch points, irrespective of the sign. If you define a switch point with a positive sign, the relay output switches as soon as the value is reached in the negative direction (negative sign), (see illustration).</p> <p>Factory setting: STANDARD</p> <p>Example for the SYMMETRY measuring mode: Switch-on point Q = 4 Switch-off point Q = 10 ① = Relay energized ② = Relay de-energized</p>  <p style="text-align: right;"><small>A0001247</small></p> <p> Note!</p> <ul style="list-style-type: none"> ▪ SYMMETRY cannot be selected unless the values in the ON VALUE (4701) and OFF-VALUE (4703) functions have the same sign or one of the values is zero. ▪ If the values have different signs, SYMMETRY cannot be selected and an "ASSIGNMENT NOT POSSIBLE" message is displayed.

Function description	
OUTPUTS → RELAY OUTPUT (1 to 2) → CONFIGURATION	
TIME CONSTANT (4706)	<p>Use this function to enter a time constant defining how the measuring signal reacts to severely fluctuating measured variables, either very quickly (enter a low time constant) or with damping (enter a high time constant). Damping acts on the measuring signal before the switch status changes, and consequently before switch-on or switch-off delay is activated. The purpose of damping, therefore, is to prevent the relay output changing state continuously in response to fluctuations in flow.</p> <p>User input: fixed-point number: 0.00...100.00 s</p> <p>Factory setting: 0.00 s</p>

7.3.2 Function group OPERATION

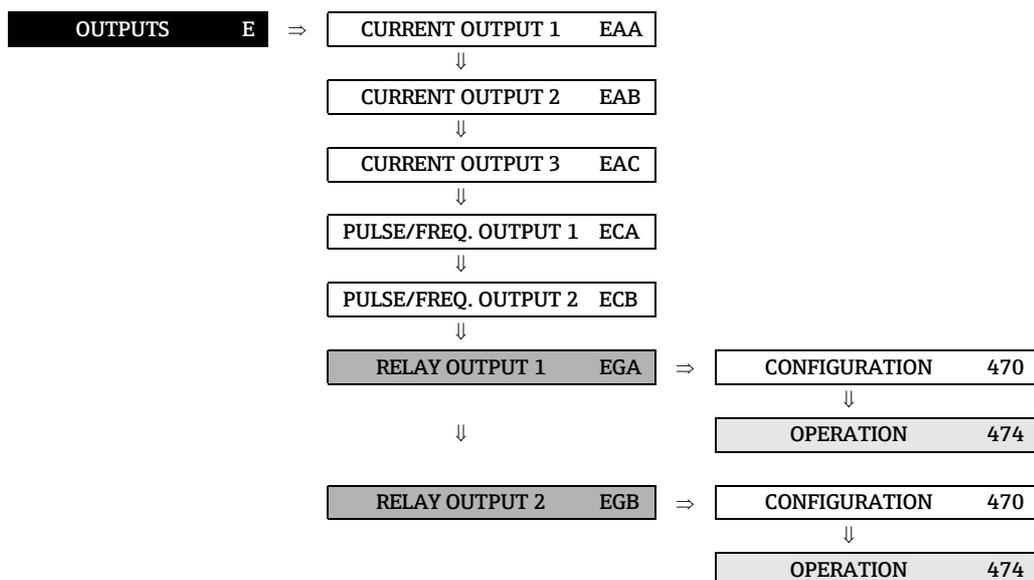

Function description	
OUTPUTS → RELAY OUTPUT (1 to 2) → OPERATION	
ACTUAL STATUS RELAY OUTPUT (4740)	<p>Use this function to check the current status of the relay output.</p> <p>A jumper on the contact side defines the relay output as a normally open (NO or make) or normally closed (NC or break) contact (see Operating Instruction <i>Proline Promass 83</i>, BA 059D/06/en).</p> <p>Display: MAKE CONTACT OPEN MAKE CONTACT CLOSED BREAK CONTACT OPEN BREAK CONTACT CLOSED</p>
SIMULATION SWITCH POINT (4741)	<p>Use this function to activate simulation of the relay output.</p> <p>Options: OFF ON</p> <p>Factory setting: OFF</p> <p> Note!</p> <ul style="list-style-type: none"> ▪ The “SIMULATION RELAY” message indicates that simulation is active. ▪ The measuring device continues to measure while simulation is in progress, i.e. the current measured values are output correctly via the other outputs. ▪ If the “BATCH VALVE 1” option was selected in the function, the functional test takes place by means of the function, → 163. <p> Caution! The setting is not saved if the power supply fails.</p>

Function description	
OUTPUTS → RELAY OUTPUT (1 to 2) → OPERATION	
VALUE SIMULATION SWITCH POINT (4742)	<p> Note! The function is not visible unless the function SIMULATION SWITCH POINT (4741) is active (= ON).</p> <p>Use this function to define the status of the relay output during the simulation. This value is used to test downstream devices and the measuring device itself. Depending on the relay configuration (as make or break contact) the following selections are available.</p> <p>Options: Relay output configured as normally open (make) contact: MAKE CONTACT OPEN MAKE CONTACT CLOSED</p> <p>Relay output configured as normally closed (break) contact: BREAK CONTACT OPEN BREAK CONTACT CLOSED</p> <p> Caution! The setting is not saved if the power supply fails.</p>

7.3.3 Function group INFORMATION

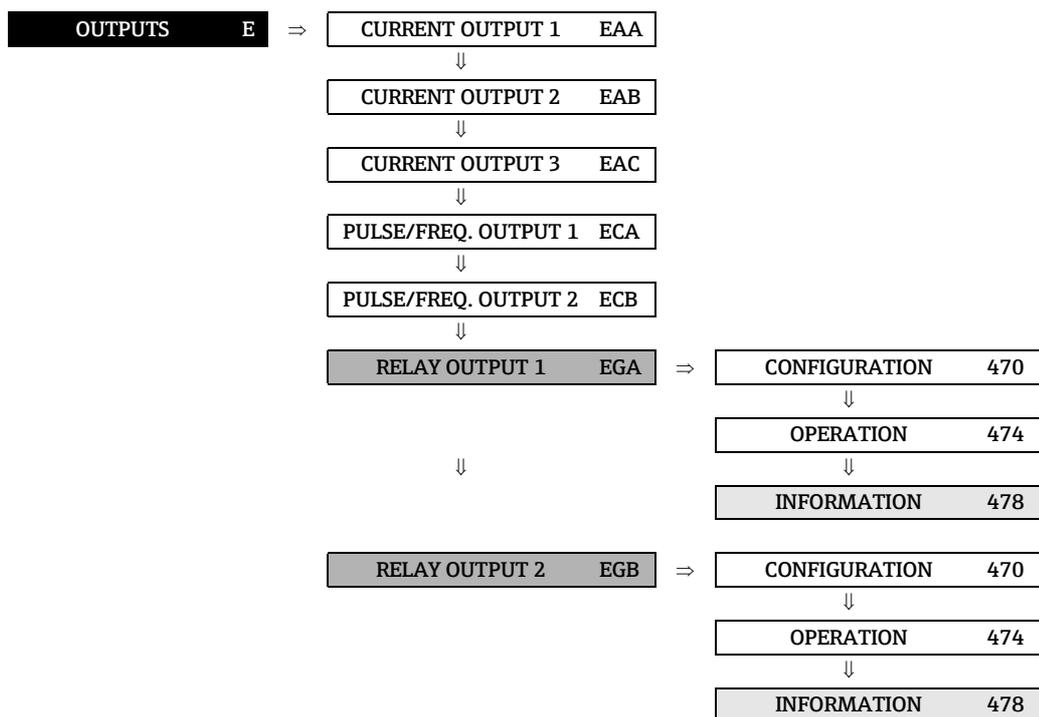

Function description	
OUTPUTS → RELAY OUTPUT (1 to 2) → INFORMATION	
TERMINAL NUMBER (4780)	Use this function to view the numbers of the terminals (in the connection compartment) and the polarity used by the relay output.

7.3.4 Information on the response of the relay output

General

If you have configured the relay output signal for “LIMIT VALUE” or “FLOW DIRECTION”, you can define the requisite switch points in the ON VALUE and OFF-VALUE functions. When the measured variable in question reaches one of these predefined values, the relay output switches as shown in the illustrations below.

Relay output configured for “flow direction”

The value you entered in the function ON-VALUE defines the switch point for the positive and negative directions of flow.

If, for example, the switch point you define is $= 1 \text{ m}^3/\text{h}$, the relay drops out at $-1 \text{ m}^3/\text{h}$ and pulls up at $+1 \text{ m}^3/\text{h}$. Set the switch point to 0 if your process calls for direct switchover (no switching hysteresis). If low flow cut off is used, it is advisable to set hysteresis to a value higher than or equal to the low flow cut off rate.

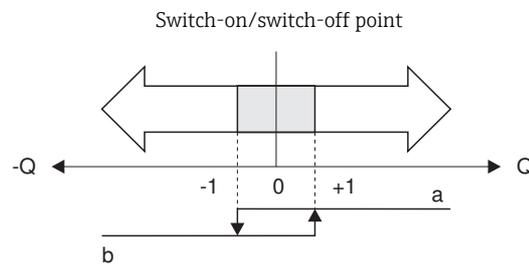

A0001236

a = Relay energized
b = Relay de-energized

Relay output configured for limit value

The relay output signal switches as soon as the measured variable undershoots or overshoots a defined switch point.

Application: Monitoring flow or process-related boundary conditions.

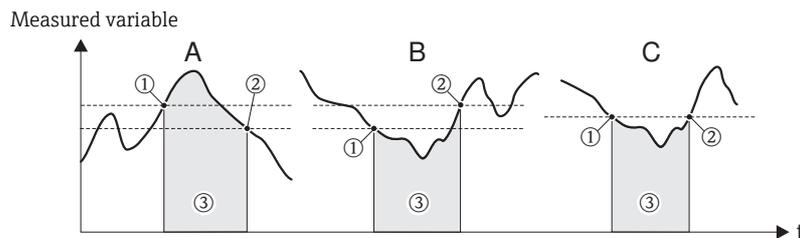

A0001235

① = SWITCH-OFF POINT, ② = SWITCH-ON POINT, ③ = Relay de-energized

A = Maximum safety (SWITCH-OFF POINT > SWITCH-ON POINT)

B = Minimum safety (SWITCH-OFF POINT < SWITCH-ON POINT)

C = Minimum safety (SWITCH-OFF POINT = SWITCH-ON POINT, this configuration is to be avoided)

7.3.5 Switching behavior of the relay output

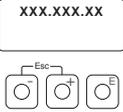
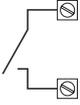
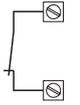
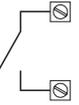
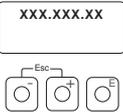
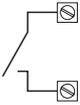
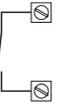
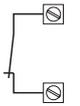
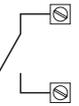
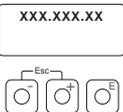
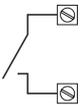
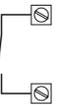
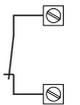
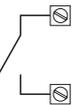
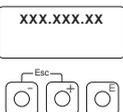
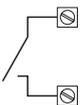
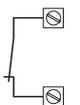
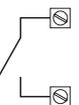
Function	State	Relay coil	Contact*	
			NC	NO
ON (operation)	System in measuring mode  A0001052	energized		
	System not in measuring mode (power supply failed)  A0001291	de-energized		
Fault message	System OK  A0001052	energized		
	(System or process error) Fault → Failsafe mode, outputs /inputs and totalizers  A0001291	de-energized		
Notice message	System OK  A0001052	energized		
	(System or process error) Fault → Continuation of measuring  A0001291	de-energized		
Fault message or Notice message	System OK  A0001052	energized		
	(System or process error) Fault → Failsafe mode or Note → Continuation of measu- ring  A0001291	de-energized		

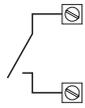
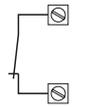
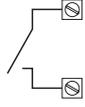
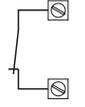
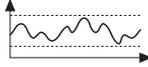
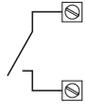
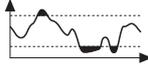
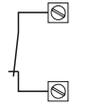
Function	State	Relay coil	Contact*		
			NC	NO	
Empty pipe detection (EPD)	Measuring tube full	 A0001292	energized		
	Measuring tube partially filled /empty measuring tube	 A0001293	de-energized		
Flow direction	forward	 A0001241	energized		
	reverse	 A0001242	de-energized		
Limit value - Mass flow - Volume flow - Corrected volume flow - Density - Reference density - Temperature - Totalizer	Limit value not overshoot or undershot	 A0001243	energized		
	Limit value overshoot or undershot	 A0001244	de-energized		
<p>* Terminal numbers in accordance with the function TERMINAL NUMBER (4780) on → 109.</p> <p> Note! If the measuring device has two relays, the factory setting is: <ul style="list-style-type: none"> ■ Relay 1 → normally open contact (NO) ■ Relay 2 → normally closed contact (NC) </p> <p> Caution! When using the optional software package BATCHING, it is advisable for the contacts (either normally open or normally closed contacts) to have the same switching response for all relay outputs used.</p>					

8 Block INPUTS

Block	Groups	Function	Functions				
INPUTS (F)	STATUS INPUT	CONFIGURATION	⇒ ASSIGN STATUS INPUT	⇒ ACTIVE LEVEL	MIN. PULSE WIDTH		
		OPERATION	⇒ ACT. STATUS IN.	⇒ SIM. STATUS IN.	VALUE SIM. STATUS IN.		
		INFORMATION	⇒ TERMINAL NUMBER				
	CURRENT INPUT	CONFIGURATION	⇒ ASSIGN CURRENT INPUT	⇒ CURRENT SPAN	VALUE 0_4 mA	VALUE 20 mA	ERROR VALUE
		OPERATION	⇒ ACTUAL VALUE CUR-	⇒ SIM. CURRENT INPUT	VALUE SIM. CUR. INP.		
		INFORMATION	⇒ TERMINAL NUMBER				

8.1 Group STATUS INPUT

8.1.1 Function group CONFIGURATION

INPUTS	F	⇒	STATUS INPUT	FAA	⇒	CONFIGURATION	500
--------	---	---	--------------	-----	---	---------------	-----

Function description	
INPUTS → STATUS INPUT → CONFIGURATION	
ASSIGN STATUS INPUT (5000)	<p>Use this function to assign a switching function to the status input.</p> <p>Options: OFF RESET TOTALIZER 1 RESET TOTALIZER 2 RESET TOTALIZER 3 RESET ALL TOTALIZERS POSITIVE ZERO RETURN RESET FAULT MESSAGE ZEROPOINT ADJUSTMENT</p> <p>Advanced options with optional software package BATCHING: RUN BATCHING (start/stop) HOLD BATCHING (stop/continue) RESET BATCH SUM (resetting total quantity / total quantity totalizers) RESET TOTALIZER 3 & START BATCHING (reset of totalizer 3, followed by start)</p> <p> Caution! If an input pulse is sent during a batching process, the batching process is canceled immediately, but totalizer 3 is not reset. This allows the partial filling to be read out correctly.</p> <p>Advanced options with optional software package ADVANCED DIAGNOSIS: ACQUISITION</p> <p> Note! This function is not available unless the SINGLE SHOT setting is selected in the ACQUISITION MODE function (7410).</p> <p>Factory setting: OFF</p> <p> Caution! POSITIVE ZERO RETURN is active as long as the level is available at the status input (continuous signal). All other assignments react to a change in level (pulse) at the status input.</p>
ACTIVE LEVEL (5001)	<p>Use this function to define whether the assigned function (see function ASSIGN STATUS INPUT) is released when the signal level is present (HIGH) or not present (LOW).</p> <p>Options: HIGH LOW</p> <p>Factory setting: HIGH</p>
MINIMUM PULSE WIDTH (5002)	<p>Use this function to define a minimum pulse width which the input pulse must achieve in order to trigger the selected switching function, (see function ASSIGN STATUS INPUT (5000)).</p> <p>User input: 20...100 ms</p> <p>Factory setting: 50 ms</p>

8.1.2 Function group OPERATION

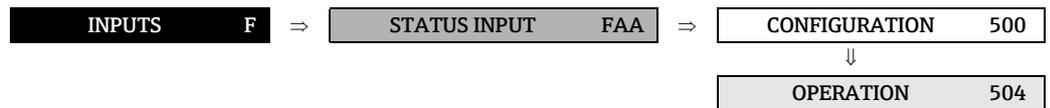

Function description INPUTS → STATUS INPUT → OPERATION	
ACTUAL STATUS INPUT (5040)	<p>Use this function to view the current level of the status input.</p> <p>Display: HIGH LOW</p>
SIMULATION STATUS INPUT (5041)	<p>Use this function to simulate the status input, in other words to trigger the function assigned to the status input (see the function ASSIGN STATUS INPUT (5000) on → 114).</p> <p>Options: OFF ON</p> <p>Factory setting: OFF</p> <p> Note!</p> <ul style="list-style-type: none"> ▪ The “SIMULATION STATUS INPUT” message indicates that simulation is active. ▪ The measuring device continues to measure while simulation is in progress, i.e. the current measured values are output correctly via the other outputs. <p> Caution! The setting is not saved if the power supply fails.</p>
VALUE SIMULATION STATUS INPUT (5042)	<p> Note! The function is not visible unless the function SIMULATION STATUS INPUT (5041) is active (= ON).</p> <p>Use this function to define the level to be assumed at the status output during the simulation. This value is used to test downstream devices and the measuring device itself.</p> <p>Options: HIGH LOW</p> <p>Factory setting: LOW</p> <p> Caution! The setting is not saved if the power supply fails.</p>

8.1.3 Function group INFORMATION

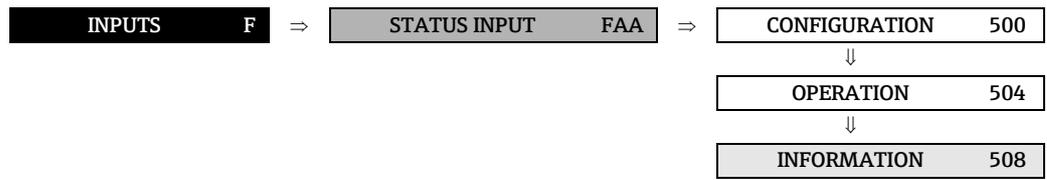

Function description INPUTS → STATUS INPUT → INFORMATION	
TERMINAL NUMBER (5080)	Use this function to view the numbers of the terminals (in the connection compartment) and the polarity used by the status input.

8.2 Group CURRENT INPUT

8.2.1 Function group CONFIGURATION

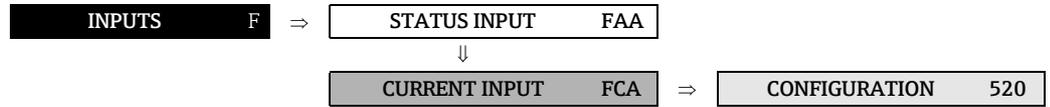

Function description INPUTS → CURRENT INPUT → CONFIGURATION	
ASSIGN CURRENT INPUT (5200)	<p>Use this function to assign a process variable to the current input.</p> <p>Options: OFF TEMPERATURE PRESSURE REFERENCE DENSITY</p> <p>Factory setting: OFF</p>
CURRENT SPAN (5201)	<p>Use this function to define the current range. The selection specifies the operational range and the lower and upper signal on alarm.</p> <p>Options: 0–20 mA 4–20 mA 4–20 mA NAMUR 4–20 mA US 0–20 mA (25 mA) 4–20 mA (25 mA)</p> <p>Factory setting: 4–20 mA NAMUR</p> <p> Note! When switching the hardware from an active (factory setting) to a passive output signal, select a current range of 4–20 mA (See Operating Instructions <i>Proline Pro-mass 83</i>, BA 059D/06/en/).</p> <p>Current range / operational range (measuring information): 0–20 mA / 0...20.5 mA 4–20 mA / 4...20.5 mA 4–20 mA NAMUR / 3.8...20.5 mA 4–20 mA US / 3.9...20.8 mA 0–20 mA (25 mA) / 0...24 ma 4–20 mA (25 mA) / 4...24 mA</p>
VALUE 0_4 mA (5202)	<p>Use this function to assign a value to the 0/4 mA current.</p> <p>User input: 5-digit floating-point number</p> <p>Factory setting: Dependent on the process variable assigned to the current input (see function ASSIGN CURRENT INPUT, 5200). – Pressure: 0 barg – Temperature: –50 °C – Reference density: 0.50 kg/Nl</p> <p> Note! The appropriate unit is taken from the functions UNIT PRESSURE (0426), UNIT TEMPERATURE (0422) or UNIT REFERENCE DENSITY (0421).</p>

Function description	
INPUTS → CURRENT INPUT → CONFIGURATION	
VALUE 20 mA (5203)	<p>Use this function to assign a value to the 20 mA current.</p> <p>User input: 5-digit floating-point number</p> <p>Factory setting: Dependent on the process variable assigned to the current input (see function ASSIGN CURRENT INPUT, 5200). <ul style="list-style-type: none"> - Pressure: 100 barg - Temperature: 200 °C - Reference density: 2.00 kg/NI </p> <p> Note! The appropriate unit is taken from the functions UNIT PRESSURE (0426), UNIT TEMPERATURE (0422) or UNIT REFERENCE DENSITY (0421).</p>
ERROR VALUE (5204)	<p>Use this function to enter a defined error value for the process variable concerned. If the current value lies outside of the selected range (see function CURRENT SPAN, 5201), then the process variable is set to the “error value” defined here and a corresponding notice message CURRENT INPUT RANGE (# 363) is generated.</p> <p>User input: 5-digit floating-point number</p> <p>Factory setting: Dependent on the process variable assigned to the current input (see function ASSIGN CURRENT INPUT, 5200). <ul style="list-style-type: none"> - Pressure: 50 barg - Temperature: 75 °C - Reference density: 1.25 kg/NI </p> <p> Note!</p> <ul style="list-style-type: none"> ▪ Triggered amplifier faults or the error behavior of the outputs do not have any influence on the current input. ▪ The appropriate unit is taken from the functions UNIT PRESSURE (0426), UNIT TEMPERATURE (0422) or UNIT REFERENCE DENSITY (0421).

8.2.2 Function group OPERATION

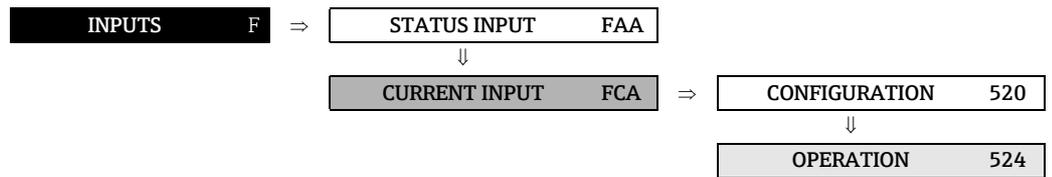

Function description INPUTS → CURRENT INPUT → OPERATION	
ACTUAL CURRENT INPUT (5240)	<p>The actual value of the input current appears on the display.</p> <p>Display: 0.0...25 mA</p>
SIMULATION CURRENT INPUT (5241)	<p>Use this function to activate simulation of the current output.</p> <p>Options: OFF ON</p> <p>Factory setting: OFF</p> <p> Note! <ul style="list-style-type: none"> ■ An active simulation is indicated by the "SIM. CURRENT 1" (# 661) notice message. ■ The value output for the simulation at the current input is defined in the function VALUE SIMULATION CURRENT INPUT (5242). ■ The measuring device remains fully operational during the simulation and the current measured values are output correctly via the other outputs and the display. </p> <p> Caution! The setting is not saved if the power supply fails.</p>
VALUE SIMULATION CURRENT INPUT (5242)	<p> Note! This function is only available if the function SIMULATION CURRENT INPUT (5241) is switched on.</p> <p>Use this function to specify a freely selectable value, e.g. 12 mA, which is to be simulated at the current input. This value is used to test downstream devices and the measuring device itself.</p> <p>User input: 0.00...25.00 mA</p> <p>Factory setting: 0.00 mA or 4 mA (depending on the setting in function 5201).</p> <p> Caution! The setting is not saved if the power supply fails.</p>

8.2.3 Function group INFORMATION

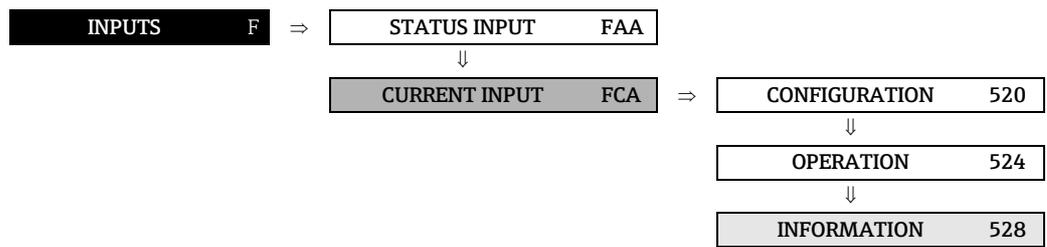

Function description	
INPUTS → CURRENT INPUT → INFORMATION	
TERMINAL NUMBER (5280)	This function is used to display the polarity and numbers of the terminals (in the terminal compartment) occupied by the current input.

9 Block BASIC FUNCTION

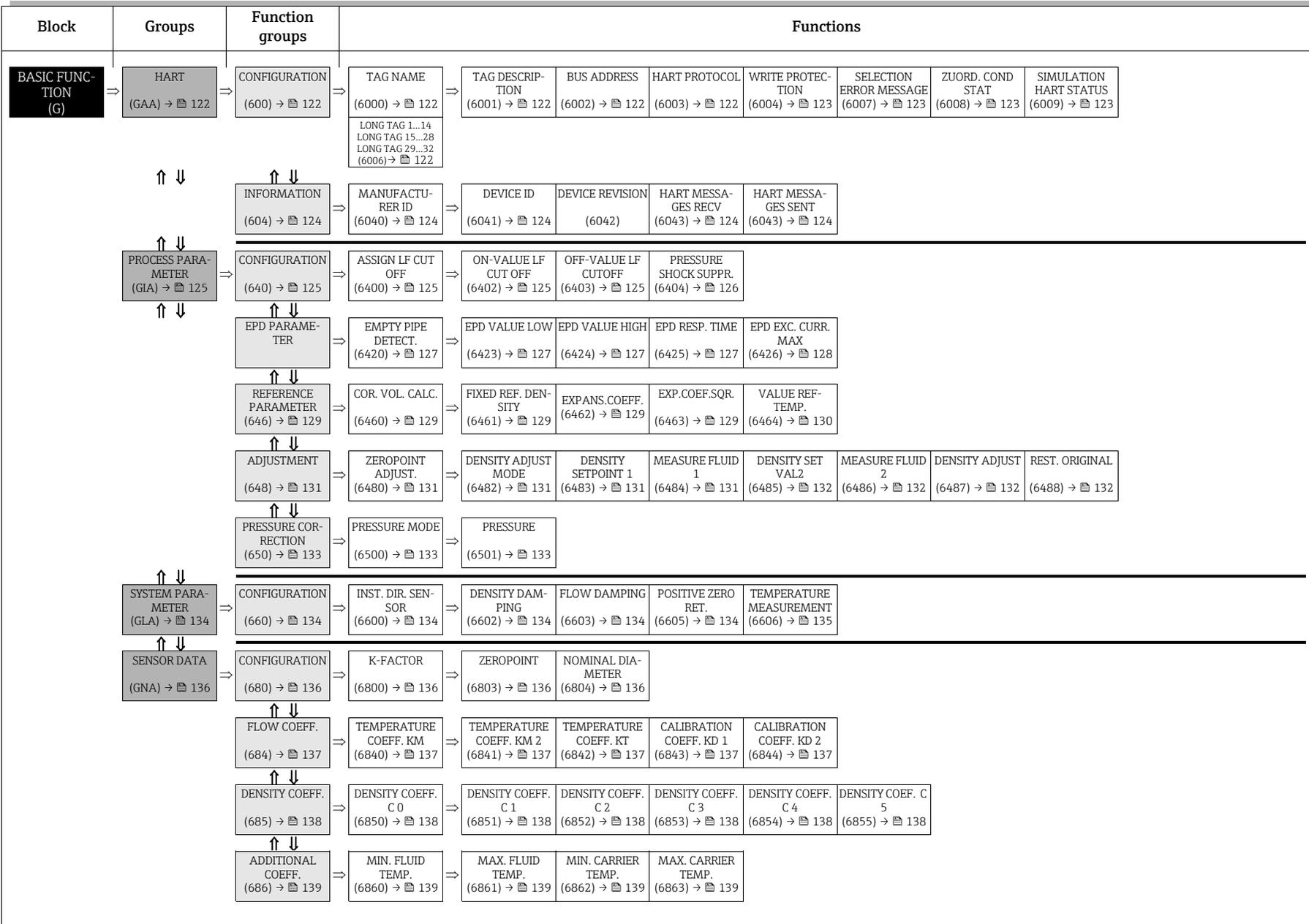

9.1 Group HART

9.1.1 Function group CONFIGURATION

BASIC FUNCTION	G	⇒	HART	GAA	⇒	CONFIGURATION	600
----------------	---	---	------	-----	---	---------------	-----

Function description	
BASIC FUNCTION → HART → CONFIGURATION	
LONG TAG 1...14 (6006) (HART 7)	Use this function to enter a tag name for the measuring device. You can edit and read this tag name at the local display or via the HART protocol.
LONG TAG 15...28 (6006) (HART 7)	User input: max. 14-character text: LONG TAG 1...14, LONG TAG 15...28 max. 4-character text: LONG TAG 29...32 permissible: A-Z, 0-9, +, -, punctuation marks
LONG TAG 29...32 (6006) (HART 7)	Factory setting: LONG TAG 1...14: "_____ " (no text) LONG TAG 15...28: "_____ " (no text) LONG TAG 29...32: "_____" (no text)
TAG NAME (6000) (HART 5)	Use this function to enter a tag name for the measuring device. You can edit and read this tag description via the local display or the HART protocol.
TAG DESCRIPTION (6001)	Use this function to enter a tag description for the measuring device. You can edit and read this tag description via the local display or the HART protocol.
BUS ADDRESS (6002)	Use this function to define the address for the exchange of data with the HART protocol.
HART PROTOCOL (6003)	Use this function to display if the HART protocol is active.

Function description BASIC FUNCTION → HART → CONFIGURATION	
WRITE PROTECTION (6004)	<p>Use this function to check whether the measuring device can be write-accessed.</p> <p>Display: OFF = Data exchange is possible ON = Data exchange disabled</p> <p>Factory setting: OFF</p> <p> Note! Write protection is activated and deactivated by means of a jumper on the I/O module (see Operating Instruction <i>Proline Promass 83</i>, BA 059D/06/en).</p>
SELECTION ERROR MESSAGE (6007) (HART 7)	<p>In this function, the error to be categorized is selected.</p> <p>Options: CANCEL #401 EMPTY PIPE #601 POS.ZERO-RET. ...</p> <p> Note! List of error messages: Operating Instructions <i>Proline Promass 83</i>, BA00059D, chapter "Trouble shooting"</p> <p>Factory setting: CANCEL</p>
ASSIGN NE107 CONDENSED STATUS (6008) (HART 7)	<p>In this function, an NE107 category is assigned to the function previously selected.</p> <p>Auswahl: CANCEL FUNCTION CHECK (C) OUT OF SPECIFICATIONS (S) MAINTENANCE REQ. (M) NO EFFECT (N)</p> <p>Factory setting: CANCEL</p>
SIMULATION HART STATUS (6009) (HART 7)	<p>In this function, the error to be simulated is selected.</p> <p>Options: CANCEL #401 EMPTY PIPE #601 POS.ZERO-RET. ...</p> <p> Note! List of error messages: Operating Instructions <i>Proline Promass 83</i>, BA00059D, chapter "Trouble shooting"</p> <p>Factory setting: CANCEL</p>

9.1.2 Function group INFORMATION

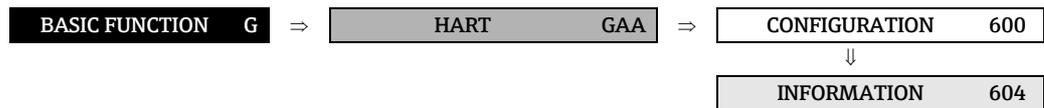

Function description	
BASIC FUNCTION → HART → OPERATION	
MANUFACTURER ID (6040)	Use this function to view the manufacturer ID in decimal numerical format. Display: - Endress+Hauser - 17 (≅ 11 hex) for Endress+Hauser
DEVICE ID (6041)	Use this function to view the device ID in hexadecimal numerical format. Display: 51 (≅ 81 dez) for Promass 83
DEVICE REVISION (6042)	Displays the device-specific revision of the HART command interface. Display: e.g.: 5
HART MESSAGES RECV (6043) (HART 7)	Returns the number of HART messages that are received without error and destined for the device in question (including broadcast messages). This does not include messages that contain a communication error but still demand a response on the part of the device (e.g. checksum error type of errors). User interface: 0 to 65535
HART MESSAGES SENT (6043) (HART 7)	Returns the number of all the messages sent by the device. Also contains the messages that are sent as a response to an incorrect request, e.g. to a request with a checksum error type of error or to a command that is not supported. User interface: 0 to 65535

9.2 Group PROCESS PARAMETER

9.2.1 Function group CONFIGURATION

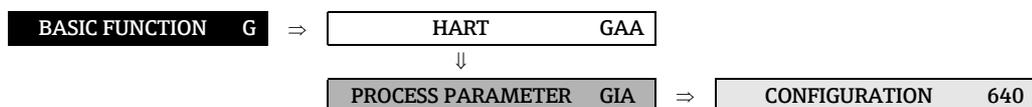

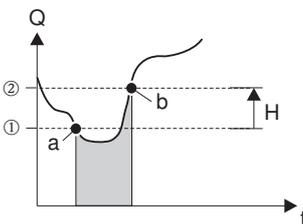
Function description	
BASIC FUNCTION → PROCESS PARAMETER → CONFIGURATION	
ASSIGN LOW FLOW CUT OFF OFF (6400)	Use this function to assign the switch point for low flow cut off rate suppression. Options: OFF MASS FLOW VOLUME FLOW CORRECTED VOLUME FLOW Factory setting: MASS FLOW
ON-VALUE LOW FLOW CUT OFF (6402)	Use this function to assign a value to the switch-on point for low flow cut off. Low flow cut off is active if the value entered is not equal to 0. The sign of the flow value is highlighted on the display to indicate that low flow cut off is active. User input: 5-digit floating-point number, [unit] Factory setting: Depends on nominal diameter  Note! The appropriate unit is taken from the function group SYSTEM UNITS (see → 17).
OFF-VALUE LOW FLOW CUT OFF (6403)	Enter the off-value (b) of the low flow cut off. Enter the switch-off point as a positive hysteresis (H) from the switch-on point (a). User input: Integer 0 to 100% Factory setting: 50% 
	A0003882 ① = On-value ② = Off-value a Low flow cut off is switched on b Low flow cut off is switched off ($a + a \cdot H$) HHysteresis: 0 to 100% ■ Low flow cut off active Q Flow

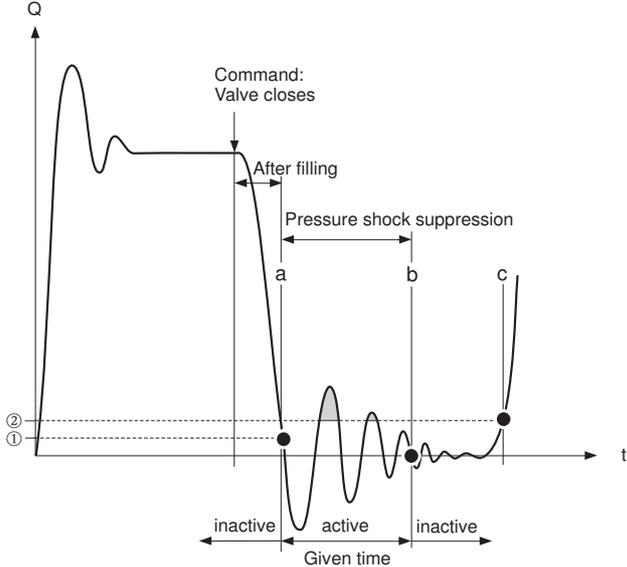
Function description	
BASIC FUNCTION → PROCESS PARAMETER → CONFIGURATION	
<p>PRESSURE SHOCK SUPPRESSION (6404)</p>	<p>The closure of a valve can cause brief but severe movements of the fluid in the piping system, movements which the measuring system registers. The pulses totaled in this way result in a totalizer reading error, particularly in the case of batching processes. For this reason, the measuring device is equipped with pressure shock suppression (= short-term signal suppression) which can eliminate system-related “disruptions”.</p> <p> Note! Note that pressure shock suppression cannot be used unless the low flow cut off is active, (see function ON-VALUE LOW FLOW CUT OFF on →  125).</p> <p>Use this function to define the time span for active pressure shock suppression.</p> <p>Activation of the pressure shock suppression Pressure shock suppression is activated after the flow falls below the switch-on point of the low flow cut off (see point a in graphic).</p> <p>While pressure shock suppression is active, the following conditions apply:</p> <ul style="list-style-type: none"> ▪ Current outputs → outputs the current corresponding to zero flow. ▪ Pulse-/Freq.-output → outputs the frequency corresponding to zero flow. ▪ Flow reading on display → 0 ▪ Totalizer reading → the totalizers are pegged at the last correct value. <p>Deactivation of the pressure shock suppression The pressure shock suppression is deactivated after the time interval, set in this function, has passed (see point b in graphic).</p> <p> Note! The actual flow value is displayed and output, when the time interval for the pressure shock suppression has passed and the flow exceeds the switch-off point of the low flow cut off (see point c in graphic).</p> <div style="text-align: center;">  </div> <p style="text-align: right; font-size: small;">A0001285-en</p> <p>① = Off-value (low flow cut off) ② = On-VALUE (low flow cut off) a Active when value falls below the on-value of the low flow cut off b Deactivated after specified time expires c Flow values are again used to calculate the pulses ■ Suppressed values Q Flow</p>
<p>PRESSURE SHOCK SUPPRESSION (6404)</p>	<p>User input: max. 4-digit number, incl. unit: 0.00...100.0 s</p> <p>Factory setting: 0.00 s</p>

9.2.2 Function group EPD PARAMETER

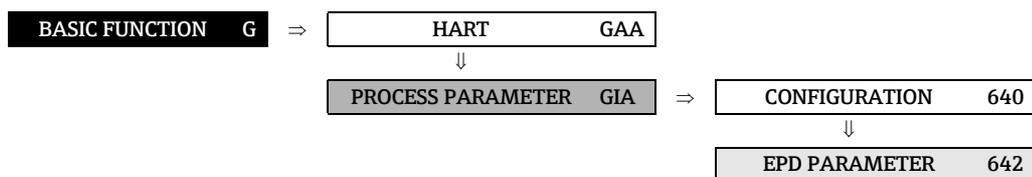

Function description	
BASIC FUNCTION → PROCESS PARAMETER → EPD PARAMETER	
EMPTY PIPE DETECTION (6420)	<p>Use this function to activate the empty pipe detection (EPD). With empty measuring tubes the density of the fluid falls below the value specified in the function EPD VALUE LOW.</p> <p>Options: OFF ON</p> <p>Factory setting: Liquid: ON Gas: OFF</p> <p> Caution!</p> <ul style="list-style-type: none"> ▪ Select a correspondingly low EPD response value in the function EPD VALUE LOW, so that the difference to the effective density of the fluid is sufficiently large enough. This ensures that totally empty measuring tubes and not partially filled ones are detected. ▪ For gas measurement we strongly recommend to switch off empty pipe detection.
EPD VALUE LOW (6423)	<p> Note! This function is not available unless the ON selection was selected in the EMPTY PIPE DETECTION function.</p> <p>Use this function to set a lower threshold for the measured density value, in order to detect possible problems in the process indicated by too low density.</p> <p>User input: 5-digit floating-point number</p> <p>Factory setting: 0.2000 kg/l</p>
EPD VALUE HIGH (6424)	<p> Note! This function is not available unless the ON selection was selected in the EMPTY PIPE DETECTION function.</p> <p>Use this function to set an upper threshold for the measured density value.</p> <p>User input: 5-digit floating-point number</p> <p>Factory setting: 6.0000 kg/l</p>
EPD RESPONSE TIME (6425)	<p>Use this function to enter the time span for which the criteria for an empty pipe have to be satisfied without interruption before a notice message or fault message is generated.</p> <p>User input: fixed-point number: 1.0...100 s</p> <p>Factory setting: 1.0 s</p>

Function description	
BASIC FUNCTION → PROCESS PARAMETER → EPD PARAMETER	
EPD EXC. CURR. MAX (6426)	<p>Use this function to activate the empty pipe detection (EPD). In the event of inhomogeneous fluids or air bubbles, the exciting current of the measuring pipes increases. If the exciting current set in this function is exceeded, error message #700 is output similar to the functions “EPD VALUE LOW (6423)” and “EPD VALUE HIGH (6423).”</p> <p>User input: 5-digit floating-point number</p> <p>Factory setting: 100 mA (deactivated)</p> <p> Note! The function is not activated until a value under 100 mA is input. Entering the value 100 mA deactivates the function.</p>

9.2.3 Function group REFERENCE PARAMETER

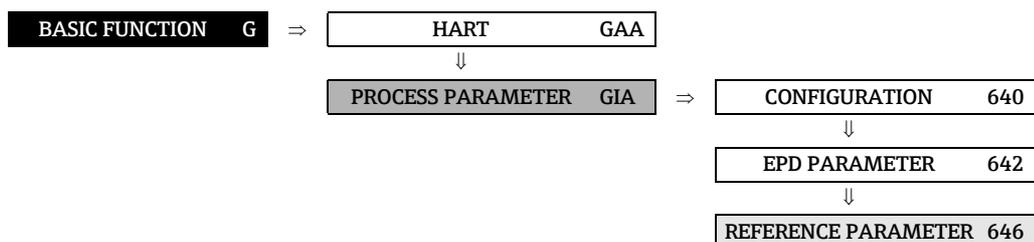

Function description	
BASIC FUNCTION → PROCESS PARAMETER → REFERENCE PARAMETER	
CORRECTED VOLUME CALCULATION (6460)	<p>This function is used to set the reference density for calculating the corrected volume flow.</p> <p>Options: FIXED REFERENCE DENSITY CALCULATED REFERENCE DENSITY EXTERN (with this option, the reference density can be read in via the current input)</p> <p>Factory setting: CALCULATED REFERENCE DENSITY</p>
FIXED REF. DENSITY (6461)	<p> Note! This function is not available unless the FIXED REFERENCE DENSITY setting was selected in the CORRECTED VOLUME CALCULATION function (6460).</p> <p>In this function, a fixed value for the reference density can be entered, with which the corrected volume flow or corrected volume is calculated.</p> <p>User input: 5-digit floating-point number</p> <p>Factory setting: 1 kg/Nl</p>
EXPANSION COEFFICIENT (6462)	<p> Note! This function is not available unless the CALCULATED REFERENCE DENSITY setting was selected in the CORRECTED VOLUME CALCULATION function (6460).</p> <p>For temperature-compensated calculations of the reference density an expansion coefficient specific to the fluid is required and can be entered in this function (see VALUE REFERENCE TEMPERATURE (6464) function on → 130).</p> <p>User input: 5-digit floating-point number</p> <p>Factory setting: 0.5000 e⁻³ [1/K]</p>
EXPANSION COEFFICIENT SQUARE (6463)	<p>Use this function to enter a square expansion coefficient, if the temperature compensation follows a nonlinear behavior (see VALUE REFERENCE TEMPERATURE (6464) function on → 130).</p> <p>User input: 5-digit floating-point number</p> <p>Factory setting: 0 e⁻⁶ [1/K²]</p>

Function description	
BASIC FUNCTION → PROCESS PARAMETER → REFERENCE PARAMETER	
VALUE REFERENCE TEMPERATURE (6464)	<p> Note! This function is not available unless the CALCULATED REFERENCE DENSITY setting was selected in the CORRECTED VOLUME CALCULATION function (6460).</p> <p>Entering the reference temperature for calculating the corrected volume flow, the corrected volume and the reference density.</p> <p>User input: 5-digit floating-point number</p> <p>Factory setting: 20.000 °C</p> <p>The reference density is calculated as follows: $\rho_N = \rho \cdot (1 + \alpha \Delta t + \beta \Delta t^2)$; Δ where $t = t - t_N$</p> <p>ρ_N = Reference density</p> <p>ρ = currently measured fluid density (measuring value Promass)</p> <p>t = Actual measured temperature of fluid (measuring value Promass)</p> <p>t_N = Reference temperature for calculating the reference density (e.g. 20 °C)</p> <p>α = Volumetric expansion coefficient of the fluid, Unit = [1/K]; K = Kelvin</p> <p>β = Square volumetric expansion coefficient of the fluid, unit = [1/K²]</p>

9.2.4 Function group ADJUSTMENT

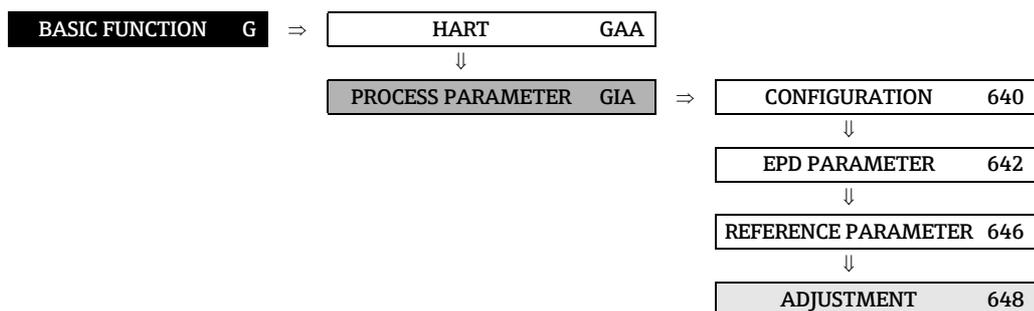

Function description	
BASIC FUNCTION → PROCESS PARAMETER → ADJUSTMENT	
ZEROPOINT ADJUSTMENT (6480)	<p>This function enables a zero point adjustment to be automatically carried out. The new zero point determined by the measuring system is adopted by the function ZEROPOINT (see →  136).</p> <p>Options: CANCEL START</p> <p>Factory setting: CANCEL</p> <p> Caution! Before carrying this out, please refer to the Operating Instructions <i>Proline Promass 83</i>, BA 059D/06/en for a detailed description of the procedure for zero point adjustment.</p> <p> Note!</p> <ul style="list-style-type: none"> Programming is locked during zero point adjustment. The message "ZERO ADJUST RUNNING" appears on the display. If the zero point adjustment is not possible (e.g. if $v > 0.1$ m/s) or has been canceled, the alarm message "ZERO ADJUST NOT POSSIBLE" appears on the display. If the Promass 83 measuring electronics are fitted with a status input, then the zero point can also be activated by using this input.
DENSITY ADJUST MODE (6482)	<p>Use this function to select whether a 1-point or a 2-point density adjustment should be carried out.</p> <p>Options: CANCEL 1-POINT 2-POINT</p>
DENSITY SETPOINT 1 (6483)	<p>Use this function to enter the density setpoint value for the first fluid for which you want to carry out field density adjustment.</p> <p>User input: 5-digit floating-point number, incl. units</p> <p> Note!</p> <ul style="list-style-type: none"> The preset density entered here should not vary from the actual fluid density by a more than $\pm 10\%$. The appropriate unit is taken from the function group SYSTEM UNITS (see →  17).
MEASURE FLUID 1 (6484)	<p>In this function the actual density of the first fluid is measured for density adjustment.</p> <p>Options: CANCEL START</p>

Function description	
BASIC FUNCTION → PROCESS PARAMETER → ADJUSTMENT	
DENSITY SETPOINT 2 (6485)	<p>Use this function to enter the density setpoint value for the second fluid for which you want to carry out field density adjustment.</p> <p>User input: 5-digit floating-point number, incl. units</p> <p> Note!</p> <ul style="list-style-type: none"> ▪ The preset density entered here should not vary from the actual fluid density by a more than $\pm 10\%$. ▪ The difference between the density setpoint values must be at least 0.2 kg/l. ▪ The appropriate unit is taken from the function group SYSTEM UNITS (see →  17).
MEASURE FLUID 2 (6486)	<p>In this function the current density of the second fluid is measured for density adjustment.</p> <p>Options: CANCEL START</p>
DENSITY ADJUST (6487)	<p>With this function a density adjustment can be carried out on site. The density adjustment values will thus be recalculated and stored. This ensures that the values dependent on density calculations (e.g. volume flow) are as accurate as possible.</p> <p> Note!</p> <p>Before carrying this out, please refer to the Operating Instructions <i>Proline Promass 83</i>, BA 059D/06/en for a detailed description of the procedure for density adjustment.</p> <p>Two types of adjustment are possible:</p> <p>1-point density adjustment (with one fluid) This type of density adjustment is necessary under the following conditions:</p> <ul style="list-style-type: none"> ▪ The sensor does not accurately measure the density which the operator expects based on laboratory trials. ▪ The characteristics of the fluid are outside the measuring points set at the factory or reference conditions under which the flowmeter has been calibrated. ▪ The plant is used solely for measuring a fluid whose density is to be determined very accurately under constant conditions. <p>2-point density adjustment (with two fluids) This type of adjustment must always be carried out when the measuring tubes are changed mechanically, e.g. due to:</p> <ul style="list-style-type: none"> ▪ Deposits ▪ Abrasion ▪ Corrosion <p>In such instances, the measuring tube resonance frequency is influenced in such a way that it is no longer compatible with the calibration data determined at the factory.</p> <p>The 2-point density adjustment takes these mechanically-based changes into account and calculates new, adjusted calibration data.</p> <p>Options: CANCEL MEASURE FLUID 1 MEASURE FLUID 2 DENSITY ADJUSTMENT</p> <p>Factory setting: CANCEL</p>
RESTORE ORIGINAL (6488)	<p>With this function the original density coefficient determined at the factory are restored.</p> <p>Options: NO YES</p> <p>Factory setting: NO</p>

9.2.5 Function group PRESSURE CORRECTION

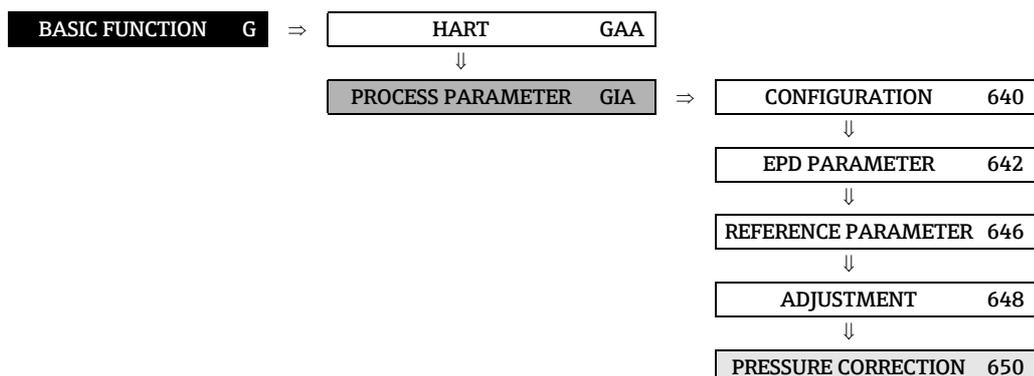

Function description	
BASIC FUNCTION → PROCESS PARAMETER → PRESSURE CORRECTION	
PRESSURE MODE (6500)	<p>Use this function to configure an automatic pressure correction. In this way, the effect of a pressure deviation between the calibration and process pressures on the measured error for mass flow is compensated for, (see also Operating Instructions <i>Proline Promass 83</i>, BA 059D/06/en, Accuracy Chapter).</p> <p>Options: OFF MEASURED This selection is only available if a current input has been selected in the function ASSIGN CURRENT INPUT (5200) PRESSURE. The actual measured process pressure is read in for pressure correction via the current input. FIX A fixed process pressure for pressure correction is specified (see function PRESSURE (6501)).</p> <p>Factory setting: OFF</p>
PRESSURE (6501)	<p> Note! This function is only available if FIX was selected in the PRESSURE MODE function (6500).</p> <p>Use this function to enter the value for the process pressure which should be used during pressure correction.</p> <p>User input: 7-digit floating-point number</p> <p>Factory setting: 0 bar g</p> <p> Note! The appropriate unit is taken from the function group SYSTEM UNITS (see → 17).</p>

9.3 Group SYSTEM PARAMETER

9.3.1 Function group CONFIGURATION

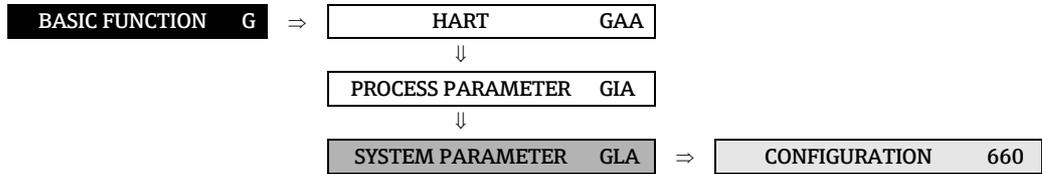

Function description BASIC FUNCTION → SYSTEM PARAMETER → CONFIGURATION	
INSTALLATION DIRECTION SENSOR (6600)	<p>Use this function to reverse the sign of the flow direction, if necessary.</p> <p> Note! Ascertain the actual direction of fluid flow with reference to the direction indicated by the arrow on the sensor (nameplate).</p> <p>Options: NORMAL (flow as indicated by the arrow) INVERSE (flow opposite to direction indicated by the arrow)</p> <p>Factory setting: NORMAL</p>
DENSITY DAMPING (6602)	<p>The density filter allows the sensitivity of the density measuring signal to be lowered with respect to variations in the density of the fluid, e.g. with inhomogeneous liquids. The damping acts on all functions and outputs of the measuring device.</p> <p>User input: max. 5-digit number, including unit: 0.00...100.00 s</p> <p>Factory setting: 0.00 s</p>
FLOW DAMPING (6603)	<p>Setting the filter depth of the digital filter. The sensitivity of the flow measurement signal can be reduced with respect to interference peaks (e.g. in the event of a high solid content, gas bubbles in the fluid etc.). The reaction time of the measuring device increases with every increase in the filter setting. The damping acts on all functions and outputs of the measuring device.</p> <p>User input: 0...100 s</p> <p>Factory setting: Liquid: 0,00 s Gas: 0,25 s</p>
POSITIVE ZERO RETURN (6605)	<p>Use this function to interrupt evaluation of measured variables. This is necessary when a piping system is being cleaned, for example. This setting acts on all function and outputs of the measuring device.</p> <p>Options: OFF ON (signal output is set to the "ZERO FLOW" value, temperature and density are still output)</p> <p>Factory setting: OFF</p>

Function description	
BASIC FUNCTION → SYSTEM PARAMETER → CONFIGURATION	
TEMPERATURE MEASUREMENT (6606)	<p>Use this function to switch between internal and external (via the current input) temperature measurement.</p> <p> Note! This cell is only available if a current input is present.</p> <p>Options: INTERNAL</p> <p>EXTERNAL This option is only available if TEMPERATURE was selected in the function ASSIGN CURRENT INPUT (5200).</p> <p>Factory setting: INTERNAL</p>

9.4 Group SENSOR DATA

9.4.1 Function group CONFIGURATION

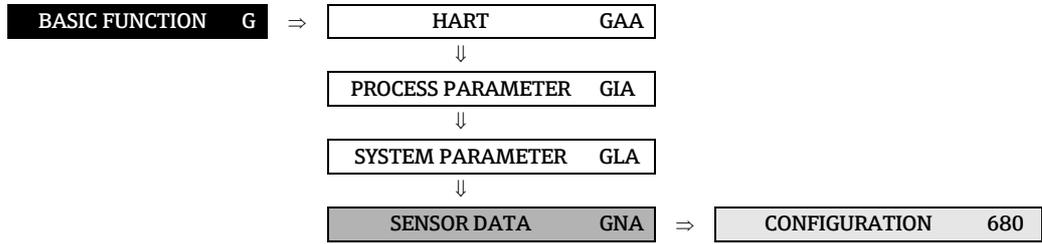

Function description	
BASIC FUNCTION → SENSOR DATA → CONFIGURATION	
<p>All sensor data (calibration factor, zero point and nominal diameter) are set at the factory and saved on the S-DAT sensor memory chip.</p> <p> Caution! Under normal circumstances you should not change the following parameter settings, because changes affect numerous functions of the entire measuring facility in general and the accuracy of the measuring system in particular. For this reason, the functions described below cannot be changed even when you enter your personal code.</p> <p>Contact the E+H service organization if you have any questions about these functions.</p> <p> Note! The individual values of the functions are also provided on the sensor nameplate.</p>	
<p>K-FACTOR (6800)</p>	<p>This function shows the current calibration factor for the sensor.</p> <p>Factory setting: Depends on nominal diameter and calibration</p>
<p>ZEROPOINT (6803)</p>	<p>This function shows the current zero point correction value for the sensor.</p> <p>Display: max. 5-digit number: -99999...+99999</p> <p>Factory setting: Depends on calibration</p>
<p>NOMINAL DIAMETER (6804)</p>	<p>This function shows the nominal diameter for the sensor.</p> <p>Factory setting: Depends on the size of the sensor</p>

9.4.2 Function group FLOW COEFFICIENT

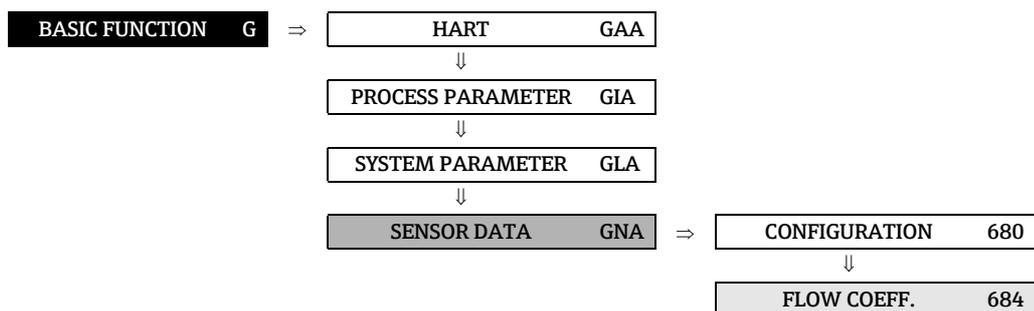

Function description	
BASIC FUNCTION → SENSOR DATA → FLOW COEFFICIENT	
All flow coefficients are set at the factory. All the sensor's parameter settings are saved on the S-DAT memory chip.	
Contact the E+H service organization if you have any questions about these functions.	
TEMPERATURE COEFFICIENT KM (6840)	This function shows the temperature coefficient KM.
TEMPERATURE COEFFICIENT KM 2 (6841)	This function shows the temperature coefficient KM 2.
TEMPERATURE COEFFICIENT KT (6842)	This function shows the temperature coefficient KT.
CALIBRATION COEFFICIENT KD 1 (6843)	This function shows the calibration coefficient KD 1.
CALIBRATION COEFFICIENT KD 2 (6844)	This function shows the calibration coefficient KD 2.

9.4.3 Function group DENSITY COEFFICIENT

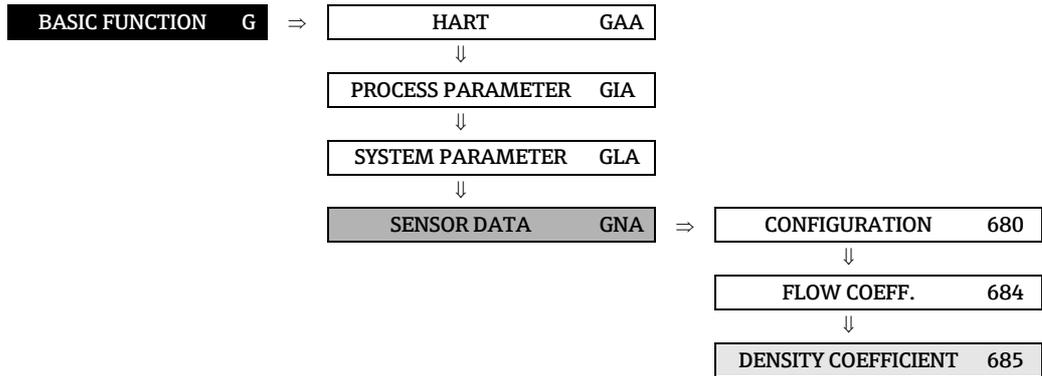

Function description	
BASIC FUNCTION → SENSOR DATA → DENSITY COEFFICIENT	
<p>All density coefficients are set at the factory. All the sensor's parameter settings are saved on the S-DAT memory chip.</p> <p>Contact the E+H service organization if you have any questions about these functions.</p>	
DENSITY COEFFICIENT C 0 (6850)	<p>This function shows the actual density coefficient C 0.</p> <p> Caution! A density adjustment can alter the calibration value of this coefficient.</p>
DENSITY COEFFICIENT C 1 (6851)	<p>This function shows the actual density coefficient C 1.</p> <p> Caution! A density adjustment can alter the calibration value of this coefficient.</p>
DENSITY COEFFICIENT C 2 (6852)	<p>This function shows the actual density coefficient C 2.</p> <p> Caution! A density adjustment can alter the calibration value of this coefficient.</p>
DENSITY COEFFICIENT C 3 (6853)	<p>This function shows the actual density coefficient C 3.</p> <p> Caution! A density adjustment can alter the calibration value of this coefficient.</p>
DENSITY COEFFICIENT C 4 (6854)	<p>This function shows the actual density coefficient C 4.</p> <p> Caution! A density adjustment can alter the calibration value of this coefficient.</p>
DENSITY COEFFICIENT C 5 (6855)	<p>This function shows the actual density coefficient C 5.</p> <p> Caution! A density adjustment can alter the calibration value of this coefficient.</p>

9.4.4 Function group ADDITIONAL COEFFICIENT

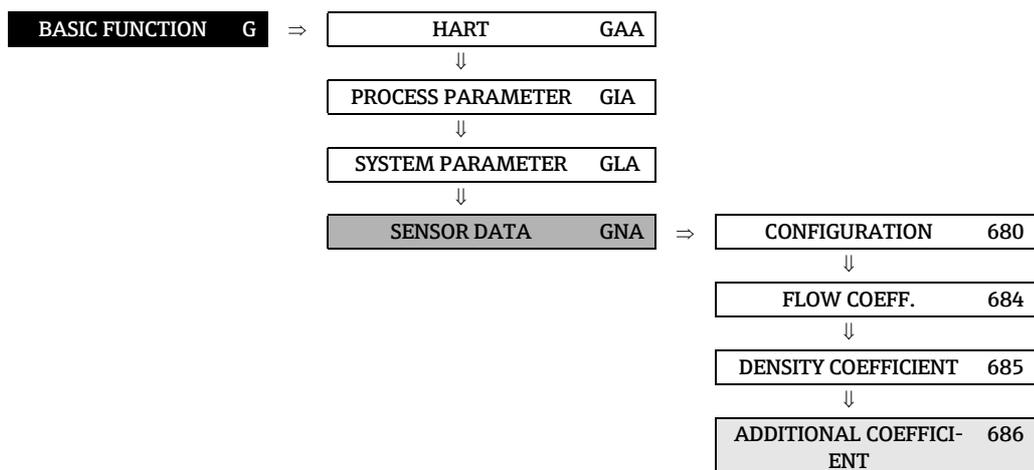

Function description	
BASIC FUNCTION → SENSOR DATA → ADDITIONAL COEFFICIENT	
<p>All sensor data are set at the factory. All the sensor's parameter settings are saved on the S-DAT memory chip.</p> <p> Caution! These functions are used for displaying device parameters only and consequently cannot be accessed.</p> <p>Contact the E+H service organization if you have any questions about these functions.</p>	
MINIMUM FLUID TEMPERATURE (6860)	The lowest fluid temperature measured appears on the display.
MAXIMUM FLUID TEMPERATURE (6861)	The highest fluid temperature measured appears on the display.
MINIMUM TEMP. CARRIER TUBE (6862)	<p> Note! This function is not available for the Promass E measuring device.</p> <p>The lowest carrier tube temperature measured appears on the display.</p>
MAXIMUM TEMPERATURE CARRIER TUBE (6863)	<p> Note! This function is not available for the Promass E measuring device.</p> <p>The highest carrier tube temperature measured appears on the display.</p>

Block	Groups	Function groups	Functions										
SPECIAL FUNCTION (H)	DENSITY FUNCTIONS (HCA) → 142 ↑ ↓	CONFIGURATION (700) → 142 ↑ ↓	DENSITY FUNCTION (7000) → 142	REF. DENSITY CARRIER FL. (7001) → 142	EXP. COEF. LIN. CARR. FL. (7002) → 142	EXP. COEF. SQR. CARR. FL. (7003) → 143	REF. DENSITY TARGET FLUID (7004) → 143	EXP. COEF. LIN. TARG. FL. (7005) → 143	EXP. COEF. SQR. TARG. FL. (7006) → 144	LINEAR EXP. COEF. (7007) → 144	SQR. EXPANSION COEFF. (7008) → 144	REFERENCE TEMPERATURE (7009) → 144	
		MODE (7021) → 145	CONCENTRATION SELECTOR (7022) → 146	CONCENTRATION NAME (7031) → 146	COEFFICIENT A0 (7032) → 146	COEFFICIENT A1 (7033) → 146	COEFFICIENT A2 (7034) → 146	COEFFICIENT A3	COEFFICIENT A4 (7036) → 147	COEFFICIENT B1 (7037) → 147	COEFFICIENT B2 (7038) → 147		
		COEFFICIENT B3 (7039) → 147											
	BATCHING FUNCTION (HCA) → 148 ↑ ↓	CONFIGURATION (720) → 148 ↑ ↓	BATCH SELECTOR (7201) → 148	BATCH NAME (7201) → 148	ASSIGN BATCH VARIABLE (7202) → 149	BATCH QUANTITY (7203) → 149	FIX COMP. QUANT. (7204) → 149	COMPENSATION MODE (7205) → 150	CALCULATION MODE (7206) → 152	AVERAGING DRIP	BATCH STAGES (7208) → 153	INPUT FORMAT (7209) → 153	
		VALVE PARAMETER (722) → 154 ↑ ↓	OPEN VALVE 1 (7220) → 154	CLOSE VALVE 1 (7221) → 154	OPEN VALVE 2 (7222) → 155	CLOSE VALVE 2 (7223) → 155							
		SUPERVISION (724) → 159 ↑ ↓	MAXIMUM BATCHING TIME (7240) → 159	MIN. BATCHING QUANTITY (7241) → 160	MAX. BATCHING QUANTITY (7242) → 161	PROGRESS NOTE (7243) → 161	MAX. FLOW (7244) → 162						
		OPERATION (726) → 163 ↑ ↓	BATCH PROCEDURE (7260) → 163	BATCH UPWARDS (7262) → 163	BATCH DOWNWARDS (7262) → 163	BATCH COUNTER (7263) → 164	BATCH SUM (7264) → 164	RESET SUM/COUNTER (7265) → 164					
		INFORMATION (728) → 165 ↑ ↓	INT. SWITCH POINT VALVE 1 (7280) → 165	DRIP QUANTITY (7281) → 165	VALVE 1 CLOSING TIME (7282) → 165	BATCHING TIME (7283) → 166							
	ADVANCED DIAGNOSIS (HEA) → 167 ↑ ↓	CONFIGURATION (740) → 167 ↑ ↓	REF. CONDITION USER (7401) → 167	SELECT REF. CONDITION (7402) → 167	WARNING MODE (7403) → 167								
		ACQUISITION (741) → 168 ↑ ↓	ACQUISITION MODE (7410) → 168	ACQUISITION PERIOD (7411) → 168	ACQUISITION DO (7412) → 168	RESET HISTORY (7413) → 168							
MASS FLOW (742) → 169 ↑ ↓		REF. VALUE MASS FLOW (7420) → 169	MASS FLOW (7421) → 169	MINIMUM VALUE (7422) → 169	MAXIMUM VALUE (7423) → 169	MASS FLOW HISTORY (7424) → 169	MASS FLOW DEVIATION (7425) → 169	WARNING LEVEL					
DENSITY (743) → 170 ↑ ↓		REF. VALUE DENSITY (7430) → 170	DENSITY (7431) → 170	MINIMUM VALUE (7432) → 170	MAXIMUM VALUE (7433) → 170	DENSITY HISTORY (7434) → 170	DENSITY DEVIATION (7435) → 170	WARNING LEVEL					
REFERENCE DENSITY (744) → 171 ↑ ↓		REF. VALUE REF. DENSITY (7440) → 171	REFERENCE DENSITY (7441) → 171	MINIMUM VALUE (7442) → 171	MAXIMUM VALUE (7443) → 171	REF. DENSITY HISTORY (7444) → 171	REF. DENSITY DEVIATION (7445) → 171	WARNING LEVEL					
TEMPERATURE (745) → 172 ↑ ↓		REF. VALUE TEMPERATURE (7450) → 172	TEMPERATURE (7451) → 172	MINIMUM VALUE (7452) → 172	MAXIMUM VALUE (7453) → 172	TEMPERATURE HISTORY (7454) → 172	TEMPERATURE DEVIATION (7455) → 172	WARNING LEVEL					
TUBE DAMPING (746) → 173 ↑ ↓		REF. VALUE TUBE DAMP. (7460) → 173	TUBE DAMPING (7461) → 173	MINIMUM VALUE (7462) → 173	MAXIMUM VALUE (7463) → 173	TUBE DAMPING HISTORY (7464) → 173	TUBE DAMPING DEVIATION (7465) → 173	WARNING LEVEL					

10 Block SPECIAL FUNCTION

Block	Groups	Function groups	Functions (continued)								
		↑ ↓ ELEC.-DYN. SENSORS (747) → 174	⇒	REF. VALUE EL. DYN. SENS. (7470) → 174	⇒	ELECTR.-DYN. SENSORS (7471) → 174	MINIMUM VALUE (7472) → 174	MAXIMUM VALUE (7473) → 174	ELEC.-DYN. SENS. HISTORY (7474) → 174	ELEC.-DYN. SENS. DEVIATION (7475) → 174	WARNING LEVEL (7476) → 174
		↑ ↓ OPERATING FREQUENCY FLUCT. (748) → 175	⇒	REF. VALUE OP. FREQ. FLUCT. (7480) → 175	⇒	OPERATING FREQUENCY FLUCT. (7481) → 175	MINIMUM VALUE	MAXIMUM VALUE (7483) → 175	OP. FREQ. FLUCT. HISTORY (7484) → 175	OP. FREQ. FLUCT. DEVIATION (7485) → 175	WARNING LEVEL (7486) → 175
		↑ ↓ TUBE DAMPING FLUCT. (749) → 176	⇒	REF. VALUE TUBE DAMP. FLUCT.	⇒	TUBE DAMPING FLUCT. (7491) → 176	MINIMUM VALUE	MAXIMUM VALUE (7493) → 176	TUBE DAMP. FLUCT. HISTORY (7494) → 176	TUBE DAMP. FLUCT. DEVIATION	WARNING LEVEL (7496) → 177

10.1 Group DENSITY FUNCTIONS

10.1.1 Function group CONFIGURATION

SPECIAL FUNCTION H	⇒	DENSITY FUNCTIONS HAA	⇒	CONFIGURATION 700
--------------------	---	-----------------------	---	-------------------

Function description	
SPECIAL FUNCTION → DENSITY FUNCTIONS → CONFIGURATION	
DENSITY FUNCTION (7000)	<p>Use this function to select the desired density function which is used to calculate special density values or the percentage proportion of components in two-phase fluids.</p> <p>User input: OFF % MASS / % VOLUME %-BLACK LIQUOR °BAUME > 1 SG °BAUME < 1 SG °API °PLATO °BALLING °BRIX FLEXIBLE</p> <p>Factory setting: OFF</p>
REFERENCE DENSITY CARRIER FLUID (7001)	<p> Note! This function is not available unless one of the following was selected in the DENSITY FUNCTION function (7000):</p> <ul style="list-style-type: none"> ▪ % MASS / % VOLUME ▪ %-BLACK LIQUOR <p>Use this function to enter the reference density (density at reference temp.) of the carrier fluid. This value is required for temperature-compensated calculation of the target fluid content in a two-phase fluid.</p> <p>User input: 5-digit floating-point number, incl. units</p> <p>Factory setting: 1.0000 kg/l</p> <p> Note! <ul style="list-style-type: none"> ▪ Carrier fluid = transporting liquid, (e.g. water) Target fluid = material transported (e.g. lime powder) ▪ The appropriate unit is taken from the function UNIT REFERENCE DENSITY (0421) (see → 20). </p>
EXPANSION COEFFICIENT LINEAR CARRIER FLUID (7002)	<p> Note! This function is not available unless one of the following was selected in the DENSITY FUNCTION function (7000):</p> <ul style="list-style-type: none"> ▪ % MASS / % VOLUME ▪ %-BLACK LIQUOR <p>Use this function to enter the fluid-specific linear expansion coefficient for the carrier fluid for linear temperature curves. This value is required for temperature-compensated calculation of the target fluid content in a two-phase fluid.</p> <p>User input: 5-digit floating-point number, including unit and sign</p> <p>Factory setting: 0.5000 e⁻³ [1/K]</p>

Function description	
SPECIAL FUNCTION → DENSITY FUNCTIONS → CONFIGURATION	
SQR. EXPANSION COEFFICIENT CARRIER FLUID (7003)	<p> Note! This function is not available unless one of the following was selected in the DENSITY FUNCTION function (7000):</p> <ul style="list-style-type: none"> ■ % MASS / % VOLUME ■ %-BLACK LIQUOR <p>Use this function to enter the fluid-specific square expansion coefficient for the carrier fluid for nonlinear temperature curves. This value is required for temperature-compensated calculation of the target fluid content in a two-phase fluid.</p> <p>User input: 5-digit floating-point number, including unit and sign</p> <p>Factory setting: 0.0000 e⁻⁶ [1/K²]</p>
REFERENCE DENSITY TARGET FLUID (7004)	<p> Note! This function is not available unless one of the following was selected in the DENSITY FUNCTION function (7000):</p> <ul style="list-style-type: none"> ■ % MASS / % VOLUME ■ %-BLACK LIQUOR <p>Use this function to enter the reference density (density at reference temperature) of the carrier fluid. This value is required for temperature-compensated calculation of the target fluid content in a two-phase fluid.</p> <p>User input: 5-digit floating-point number, incl. units</p> <p>Factory setting: 1.0000 kg/l</p> <p> Note!</p> <ul style="list-style-type: none"> ■ Carrier fluid = transporting liquid, (e.g. water) Target fluid = material transported (e.g. lime powder) ■ The appropriate unit is taken from the function UNIT REFERENCE DENSITY (0421) (see → 20).
EXPANSION COEFFICIENT LINEAR TARGET FLUID (7005)	<p> Note! This function is not available unless one of the following was selected in the DENSITY FUNCTION function (7000):</p> <ul style="list-style-type: none"> ■ % MASS / % VOLUME ■ %-BLACK LIQUOR <p>Use this function to enter the fluid-specific linear expansion coefficient for the carrier fluid for linear temperature curves. This value is required for temperature-compensated calculation of the target fluid content in a two-phase fluid.</p> <p>User input: 5-digit floating-point number, including unit and sign</p> <p>Factory setting: 0.5000 e⁻³ [1/K]</p>

Function description	
SPECIAL FUNCTION → DENSITY FUNCTIONS → CONFIGURATION	
SQR. EXPANSION COEFFICIENT TARGET FLUID (7006)	<p> Note! This function is not available unless one of the following was selected in the DENSITY FUNCTION function (7000):</p> <ul style="list-style-type: none"> ▪ % MASS / % VOLUME ▪ %-BLACK LIQUOR <p>Use this function to enter the fluid-specific square expansion coefficient for the carrier fluid for nonlinear temperature curves. This value is required for temperature-compensated calculation of the target fluid content in a two-phase fluid.</p> <p>User input: 5-digit floating-point number, including unit and sign</p> <p>Factory setting: 0.0000 e-6 [1/K²]</p>
LINEAR EXPANSION COEFFICIENT (7007)	<p> Note! This function is not available unless one of the following was selected in the DENSITY FUNCTION function (7000):</p> <ul style="list-style-type: none"> ▪ °BAUME < 1 SG ▪ °BAUME > 1 SG ▪ °API ▪ °PLATO ▪ °BALLING ▪ °BRX <p>Use this function to enter the fluid-specific linear expansion coefficient (for linear temperature curves), to calculate the temperature-compensated density functions.</p> <p>User input: 5-digit floating-point number, including unit and sign</p> <p>Factory setting: 0.5000 e-3 [1/K]</p>
SQR. EXPANSION COEFFICIENT (7008)	<p> Note! This function is not available unless one of the following was selected in the DENSITY FUNCTION function (7000):</p> <ul style="list-style-type: none"> ▪ °BAUME < 1 SG ▪ °BAUME > 1 SG ▪ °API ▪ °PLATO ▪ °BALLING ▪ °BRX <p>Use this function to enter the fluid-specific square expansion coefficient (for nonlinear temperature curves), to calculate the temperature-compensated density functions.</p> <p>User input: 5-digit floating-point number, including unit and sign</p> <p>Factory setting: 0.0000 e-6 [1/K²]</p>
REFERENCE TEMPERATURE (7009)	<p> Note! This function is only available if OFF, °BRX or FLEXIBLE was not selected in the function DENSITY FUNCTION (7000).</p> <p>Use this function to enter the reference temperature for the density functions and for calculating the corrected volume flow and the corrected volume.</p> <p>User input: 4-digit fixed-point number, including unit and sign</p> <p>Factory setting: 20 °C</p>

Function description	
SPECIAL FUNCTION → DENSITY FUNCTIONS → CONFIGURATION	
MODE (7021)	<p> Note! This function is not available unless the FLEXIBLE setting was selected in the DENSITY FUNCTION function (7000).</p> <p>Use this function to select a user-specific method of calculating the concentration of the density and temperature measured.</p> <p>In order to use this function, the following values are required:</p> <ul style="list-style-type: none"> ■ Concentration (see formula) ■ Currently measured density ■ Currently measured temperature <p>The concentration is calculated from the density and temperature as follows: $K = A0 + A1 \cdot \rho + A2 \cdot \rho^2 + A3 \cdot \rho^3 + A4 \cdot \rho^4 + B1 \cdot T + B2 \cdot T^2 + B3 \cdot T^3$</p> <p>K = Concentration ρ = currently measured density A0 = Value from function COEFFICIENT A0 (7032) A1 = Value from function COEFFICIENT A1 (7033) A2 = Value from function COEFFICIENT A2 (7034) A3 = Value from function COEFFICIENT A3 (7035) A4 = Value from function COEFFICIENT A4 (7036) B1 = Value from function COEFFICIENT B1 (7037) B2 = Value from function COEFFICIENT B2 (7038) B3 = Value from function COEFFICIENT B3 (7039) T = currently measured temperature in °C</p> <p>Options: % MASS 3D % VOLUME 3D % MASS 2D % VOLUME 2D OTHERS 3D OTHERS 2D</p> <p>Factory setting: % MASS 3D</p> <p> Note! If the relation between concentration density and temperature is given as table, the equation coefficients can be determined by Endress+Hauser e.g. via a coefficient calculation program and transmitted to the measuring device.</p>

Function description	
SPECIAL FUNCTION → DENSITY FUNCTIONS → CONFIGURATION	
CONCENTRATION SELECTOR (7022)	<p>Use this function to select a concentration specification. There are four different concentration specifications available, via which various concentrations can be defined.</p> <p>Options: CONC. # 1 (or the name that has been defined in the function CONCENTRATION NAME (7031) for concentration specification 1) CONC. # 2 (or the name that has been defined in the function CONCENTRATION NAME (7031) for concentration specification 2) CONC. # 3 (or the name that has been defined in the function CONCENTRATION NAME (7031) for concentration specification 3) CONC. # 4 (or the name that has been defined in the function CONCENTRATION NAME (7031) for concentration specification 4)</p> <p>Factory setting: CONC. # 1</p> <p> Note!</p> <ul style="list-style-type: none"> ▪ By selecting a concentration specification and the (subsequent) relevant settings, up to 4 different concentrations can be preconfigured and selected when needed. ▪ All settings in the subsequent functions of this function group are each only valid for the concentration specification selected in the function CONCENTRATION SELECTOR (7022). In other words, the entry or option is assigned to the concentration specification currently selected (e.g. in the factory setting CONC. # 1).
CONCENTRATION NAME (7031)	<p>Use this function to assign a specific name to the concentration specification.</p> <p>User input: max. 8-character text, permissible: A-Z, 0-9</p> <p>Factory setting: Name of concentration specification (depends on selection in the function CONCENTRATION SELECTOR (7022), e.g. "CONC. # 1").</p>
COEFFICIENT A0 (7032)	<p>Coefficient A0 entry.</p> <p>User input: 5-digit floating-point number</p> <p>Factory setting: 0</p>
COEFFICIENT A1 (7033)	<p>Coefficient A1 entry.</p> <p>User input: 5-digit floating-point number</p> <p>Factory setting: 0</p>
COEFFICIENT A2 (7034)	<p>Coefficient A2 entry.</p> <p>User input: 5-digit floating-point number</p> <p>Factory setting: 0</p>
COEFFICIENT A3 (7035)	<p>Coefficient A3 entry.</p> <p>User input: 5-digit floating-point number</p> <p>Factory setting: 0</p>

Function description	
SPECIAL FUNCTION → DENSITY FUNCTIONS → CONFIGURATION	
COEFFICIENT A4 (7036)	<p>Coefficient A4 entry.</p> <p>User input: 5-digit floating-point number</p> <p>Factory setting: 0</p>
COEFFICIENT B1 (7037)	<p> Note! This function does only appear if the option % MASS 3D, % VOLUME 3D or OTHERS 3D was selected in the function MODE (7021).</p> <p>Coefficient B1 entry.</p> <p>User input: 5-digit floating-point number</p> <p>Factory setting: 0</p>
COEFFICIENT B2 (7038)	<p> Note! This function does only appear if the option % MASS 3D, % VOLUME 3D or OTHERS 3D was selected in the function MODE (7021).</p> <p>Coefficient B2 entry.</p> <p>User input: 5-digit floating-point number</p> <p>Factory setting: 0</p>
COEFFICIENT B3 (7039)	<p> Note! This function does only appear if the option % MASS 3D, % VOLUME 3D or OTHERS 3D was selected in the function MODE (7021).</p> <p>Coefficient B3 entry.</p> <p>User input: 5-digit floating-point number</p> <p>Factory setting: 0</p>

10.2 Group BATCHING FUNCTION

10.2.1 Function group CONFIGURATION

SPECIAL FUNCTION H ⇒ BATCHING FUNCTION HCA ⇒ CONFIGURATION 720

Function description	
SPECIAL FUNCTION → BATCHING FUNCTION → CONFIGURATION	
BATCH SELECTOR (7200)	<p>Use this function to select a batching specification. There are six different batching specifications available by means of which different batchings can be defined.</p> <p>Options:</p> <p>BATCH # 1 (or the name which was defined for batching specification 1 in the function BATCH NAME (7201))</p> <p>BATCH # 2 (or the name which was defined for batching specification 2 in the function BATCH NAME (7201))</p> <p>BATCH # 3 (or the name which was defined for batching specification 3 in the function BATCH NAME (7201))</p> <p>BATCH # 4 (or the name which was defined for batching specification 4 in the function BATCH NAME (7201))</p> <p>BATCH # 5 (or the name which was defined for batching specification 5 in the function BATCH NAME (7201))</p> <p>BATCH # 6 (or the name which was defined for batching specification 6 in the function BATCH NAME (7201))</p> <p>Factory setting: BATCH #1</p> <p> Note!</p> <ul style="list-style-type: none"> ▪ By selecting a batching specification and its related settings (explained below), up to 6 different batchings can be preconfigured and selected as necessary. ▪ All the following functions in this function group, as well as the functions in the function groups VALVE PARAMETER (722) and SUPERVISION (724) are assigned to the batching specification selected here. ▪ All the settings in the following functions of this function group are valid only for the batching specification selected in the function BATCH SELECTOR (7200). In other words, the entry or option is assigned to the batching specification currently selected (e.g. in the factory setting BATCH # 1).
BATCH NAME (7201)	<p>Use this function to assign a specific name to the batching specification.</p> <p>User input: max. 8-character text, permissible: A-Z, 0-9</p> <p>Factory setting: Name of batching specification (depends on selection in the function BATCH SELECTOR (7200), e.g. "BATCH # 1").</p> <p> Note!</p> <p>Once an entry has been made (e.g. "BEER 33"), the batch name (BEER 33) appears in the home position when selecting the quantity and the name of the batching specification (e.g. "BATCH # 1") no longer appears.</p>

Function description SPECIAL FUNCTION → BATCHING FUNCTION → CONFIGURATION	
ASSIGN BATCH VARIABLE (7202)	<p>Use this function to assign a batching variable to the batching specification.</p> <p>Options: OFF MASS FLOW VOLUME FLOW CORRECTED VOLUME FLOW</p> <p>Advanced options with optional software package CONCENTRATION: TARGET MASS TARGET VOLUME TARGET CORRECTED VOLUME CARRIER MASS CARRIER VOLUME CARRIER CORRECTED VOLUME</p> <p>Factory setting: OFF</p> <p> Note!</p> <ul style="list-style-type: none"> ▪ The possible assignments of the display functions are automatically extended. Once a batching variable has been selected (MASS or VOLUME), you can locally define the application-specific function of the minus key (start-stop-continue) and the plus key (stop-batching name/quantity) in the information line by means of the “batching menu” assignment. In this way, a direct batching control station is made available locally at the measuring device by means of the user interface and the controls. ▪ Select OFF if the BATCHING functionality is no longer to be used. All settings related to the function (e.g. switching contact assigned to the relay output) must be assigned to another functionality.
BATCH QUANTITY (7203)	<p>Use this function to define the quantity to be batched.</p> <p>User input: 5-digit floating-point number</p> <p>Factory setting: 0 [unit]</p> <p> Note!</p> <ul style="list-style-type: none"> ▪ The appropriate unit is taken from the function group SYSTEM UNITS (ACA), (see →  17). ▪ When the batching quantity entered here is achieved, valve 1 closes (see function CLOSE VALVE 1 (7221) on →  154).
FIX COMPENSATION QUANTITY (7204)	<p>Use this function to specify a positive or negative compensation quantity. The compensation quantity balances out a constant, system-related incorrect quantity. This can be caused, for example, by a pump over-running or by the closing time of a valve. The compensation quantity is determined by the system operator. A negative compensation quantity must be specified for overbatching and a positive compensation quantity for underbatching.</p> <p> Note! The compensation quantity affects batching quantity only and does not affect the after run compensation.</p> <p>User input: Floating-point number with sign (depends on nominal diameter)</p> <p>Factory setting: 0 [unit]</p> <p> Note!</p> <ul style="list-style-type: none"> ▪ If the entry range is not sufficient for the compensation quantity, the batching quantity may have to be adjusted. ▪ The appropriate unit is taken from the function group SYSTEM UNITS (ACA), (see →  17).

Function description	
SPECIAL FUNCTION → BATCHING FUNCTION → CONFIGURATION	
COMPENSATION MODE (7205)	<p>Use this function to determine whether the after run quantity or a fixed compensation quantity should be taken into account at the next batching.</p> <p>Options: OFF MODE 1 MODE 2</p> <p>Factory setting: OFF</p> <p> Note! The pressure shock suppression must be switched off if MODE 1 or MODE 2 is selected in this function (siehe Funktion PRESSURE SHOCK SUPPRESSION (6404) auf Seite 126).</p> <p>Detailed explanations and information When batching using the optional software package BATCHING, process-related variable after run quantities or incorrect quantities can be determined and balanced out (by computer) by means of various functions. This ensures a high level of accuracy throughout the entire batching range.</p> <ul style="list-style-type: none"> ▪ Response when OFF is selected: The batching ends as soon as the quantity specified in the function BATCH QUANTITY (7203) has been achieved. If after running occurs, this is not recorded and is not taken into consideration during the next batching. In this way, in the event of process-related after running, the effective batched quantity is generally larger than the batching quantity specified. ▪ Response when MODE 1 is selected: For short batchings and for batching cycles that follow on quickly from one other. Batching ends before the quantity specified in the function BATCH QUANTITY (7203) is achieved and the after run quantity is recorded. The exact batching switch-off time is calculated based on the previous after run quantities. The number of after run quantities which are to influence the calculation can be specified in the functions AVERAGING DRIP (7207) and CALCULATION MODE (7206). The after run quantity in MODE 1 is determined between the switch-off point and the first undershooting of the low flow cut off. Any subsequent fluid movements are not taken into account. <p>(continued on next page)</p>

Function description

SPECIAL FUNCTION → BATCHING FUNCTION → CONFIGURATION

COMPENSATION MODE
(continued)

■ Response when MODE 2 is selected:

For batchings where batching accuracy is vital and where process-related fluctuations in flow occur during after running. Batching ends before the quantity specified in the function BATCH QUANTITY (7203) is achieved and the after run quantity is recorded. The exact batching switch-off time is calculated based on the previous after run quantities.

The number of after run quantities which are to influence the calculation can be specified in the functions AVERAGING DRIP (7207) and CALCULATION MODE (7206). The after run quantity in MODE 2 is determined between the switch-off point and the **constant** undershooting of the low-flow cut off. This means that the lower the setting is for the low-flow cut off, the longer the after run quantity is recorded. The batching is very accurate.

Example diagram of a batching sequence and the respective response in MODE 1 and MODE 2:

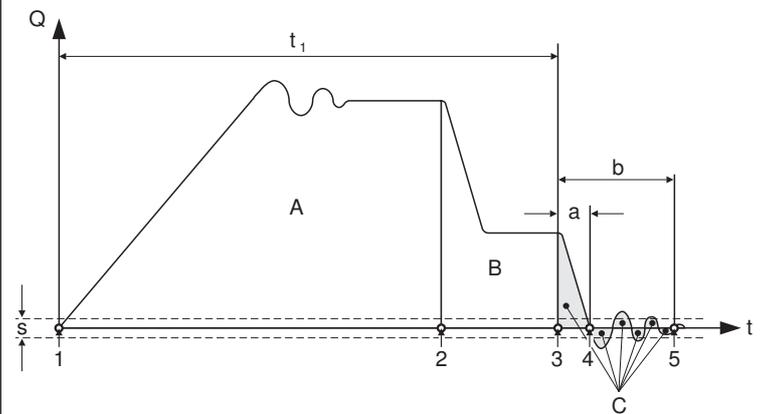

A0004711

Q = Flow

t = Time

 t_1 = time period shorter than or equal to the maximum batching time

A = Coarse batching quantity

B = Fine batching quantity

C = After run quantity

(Effective batching quantity = A + B + C)

1 = Coarse batching starts and valve 2 opens (two-stage batching)

2 = Coarse batching ends / fine batching starts, valve 2 closes, valve 1 opens

3 = Fine batching ends, valve 1 closes (automatically when the specified batching quantity is achieved)

4 = After run quantity recording in MODE 1 ends

5 = After run quantity recording in MODE 2 ends

a = After run quantity recorded in MODE 1

b = After run quantity recorded in MODE 2

s = Low flow cut off

Function description	
SPECIAL FUNCTION → BATCHING FUNCTION → CONFIGURATION	
CALCULATION MODE (7206)	<p> Note! This function is only available if MODE 1 or MODE 2 was selected in the COMPENSATION MODE function (7206).</p> <p>Use this function to select the method for calculating the recorded after run quantities.</p> <p>Options: ALL All after run quantities are used in the calculation.</p> <p>SELECTION The after run quantities recorded are filtered. The smallest and largest after run quantity are not taken into account in the calculation (extreme value filter).</p> <p>Factory setting: ALL</p> <p> Note! Machine-related (larger) “<i>extreme values</i>”, occurring especially at startup, delay correction and distort real reproducibility. By selecting “SELECT”, these “<i>extreme values</i>” are not taken into account.</p> <p>Example: Function CALCULATION MODE (7206) = SELECTION Function AVERAGING DRIP (7207) = 5 From five after run quantities recorded, the largest and smallest are not used. From the remaining three after run quantities, an average after run quantity is calculated which is taken into account at the next batching.</p>
AVERAGING DRIP (7207)	<p> Note! This function is only available if MODE 1 or MODE 2 was selected in the COMPENSATION MODE function (7206).</p> <p>Use this function to specify the number of after run quantities (cycles) which are included in calculating the batching compensation mode, MODE 1 or MODE 2.</p> <p> Note! The value entered in this function influences the measuring system reaction time.</p> <p>If you specify:</p> <ul style="list-style-type: none"> ▪ a small calculation depth (low value entered) = measuring system reacts quickly to differing amount of after run quantities. ▪ a large calculation depth (high value entered) = measuring system reacts slowly to changing after run quantities. <p>User input: 0...100</p> <p>Factory setting: 0 [cycles]</p>

Function description SPECIAL FUNCTION → BATCHING FUNCTION → CONFIGURATION	
BATCH STAGES (7208)	<p>Use this function to define the number of batching stages. Batching can be carried out in several stages, e.g. 2-stage batching with fast and precise batching.</p> <p>Options: 1-stage (1 valve or 1-stage batching) 2-stage (2 valves or 2-stage batching)</p> <p>Factory setting: 1-stage (1 valve or 1-stage batching)</p> <p> Note!</p> <ul style="list-style-type: none"> ▪ The batching stage selection (number of valves) is directly dependent on the configuration of the outputs. For 2-stage batching two relay outputs must be available in the measuring device. ▪ The functions available in the function group VALVE PARAMETER (→  154) are dependent on the number of batching stages (number of valves) selected in this function.
INPUT FORMAT (7209)	<p>Use this function to define the entry format of the quantities for the switch points of the valves.</p> <p>Options: VALUE-INPUT (e.g. 10 [unit]) %-INPUT (e.g. 80 [%])</p> <p>Factory setting: VALUE-INPUT</p> <p> Note!</p> <p>The entry format selected in this function is also used in the function groups VALVE PARAMETER (→  154) and SUPERVISION (→  159).</p>

10.2.2 Function group VALVE PARAMETER

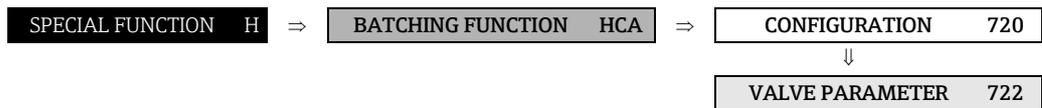

Function description SPECIAL FUNCTION → BATCHING FUNCTION → VALVE PARAMETER	
<p>The parameters for the switching contacts of up to 2 valves can be set in the following functions. The number of switching contacts (valves) available, and thus their settings in this group, is defined in the function BATCH STAGES (7208).</p> <p> Note! The following functions are only available if at least one batch stage has been selected in the function BATCH SELECTOR (7200).</p>	
OPEN VALVE 1 (7220)	<p>Use this function to specify the quantity value at which contact 1 opens. This is used as a switch point for valve 1 to output via an assigned output. The quantity value is entered as a % or as an absolute value, depending on the option in the function INPUT FORMAT (7209).</p> <p>User input: 0 to max. value or 0 to 100% (related to the batch quantity)</p> <p>Factory setting: 0 [unit] or 0 [%]</p> <p> Note!</p> <ul style="list-style-type: none"> ▪ Dynamic tracking for %-data: If the value is entered as a %, this %-value always refers to the batching quantity (e.g. 70% of a batching quantity of 10 liters = 7 liters). If the BATCH QUANTITY (7203) is adjusted (reduced/increased), the effective quantity switch point is automatically and dynamically adjusted (e.g. taking 70% and changing the batching quantity from 10 to 20 liters, the quantity switch point is adjusted from 7 liters to 14 liters). ▪ Dynamic tracking for value-data: If you enter value-input, this value is “absolute” for batching quantities that do not change (e.g. always 7 liters for a batching quantity of 10 liters). If the batching quantity (7203) is adjusted (reduced/increased), the quantity switch point is automatically and dynamically adjusted/tracked (e.g. with a new batching quantity changing from 10 to 20 liters, the quantity switch point is adjusted from 7 liters to 14 liters). In other words, the existing value data is tracked as a percentage of the altered batching quantity.
CLOSE VALVE 1 (7221)	<p>Use this function to display the quantity value at which contact 1 (valve 1) closes. The quantity value is displayed either as a % or as an absolute value, depending on the option in the function INPUT FORMAT (7209).</p> <p>Display: Value or 100% (corresponds to the batching quantity)</p> <p>Factory setting: 0 [unit] or 0 [%]</p> <p> Note! The switching contact for valve 1 is the “main contact”, i.e. the closing function of valve 1 is firmly assigned to the batching quantity entered, (see function BATCH QUANTITY (7203) on → 149). In this way, function CLOSE VALVE 1 is also the basis for calculating the after run quantity.</p>

Function description	
SPECIAL FUNCTION → BATCHING FUNCTION → VALVE PARAMETER	
OPEN VALVE 2 (7222)	<p>Use this function to specify the quantity value at which contact 2 opens. This is used as a switch point for valve 2 to output via an assigned output. The quantity value is entered as a % or as an absolute value, depending on the option in the function INPUT FORMAT (7209).</p> <p>User input: 0 to max. value or 0 to 100% (related to the batch quantity)</p> <p>Factory setting: 0 [unit] or 0 [%]</p> <p> Note!</p> <ul style="list-style-type: none"> ▪ Dynamic tracking for %-data: If the value is entered as a %, this %-value always refers to the batching quantity (e.g. 70% of a batching quantity of 10 liters = 7 liters). If the BATCH QUANTITY (7203) is adjusted (reduced/increased), the effective quantity switch point is automatically and dynamically adjusted (e.g. taking 70% and changing the batching quantity from 10 to 20 liters, the quantity switch point is adjusted from 7 liters to 14 liters). ▪ Dynamic tracking for value-data: If you enter value-input, this value is “absolute” for batching quantities that do not change (e.g. always 7 liters for a batching quantity of 10 liters). If the batching quantity (7203) is adjusted (reduced/increased), the quantity switch point is automatically and dynamically adjusted/tracked (e.g. with a new batching quantity changing from 10 to 20 liters, the quantity switch point is adjusted from 7 liters to 14 liters). In other words, the existing value data is tracked as a percentage of the altered batching quantity.
CLOSE VALVE 2 (7223)	<p>Use this function to specify the quantity value at which contact 2 closes. This is used as a switch point for valve 2 to output via an assigned output. The quantity value is entered as a % or as an absolute value, depending on the option in the function INPUT FORMAT (7209).</p> <p>User input: 0 to max. value or 0 to 100% (related to the batch quantity)</p> <p>Factory setting: 0 [unit] or 0 [%]</p> <p> Note!</p> <ul style="list-style-type: none"> ▪ Dynamic tracking for %-data: If the value is entered as a %, this %-value always refers to the batching quantity (e.g. 70% of a batching quantity of 10 liters = 7 liters). If the BATCH QUANTITY (7203) is adjusted (reduced/increased), the effective quantity switch point is automatically and dynamically adjusted (e.g. taking 70% and changing the batching quantity from 10 to 20 liters, the quantity switch point is adjusted from 7 liters to 14 liters). ▪ Dynamic tracking for value-data: If you enter value-input, this value is “absolute” for batching quantities that do not change (e.g. always 7 liters for a batching quantity of 10 liters). If the batching quantity (7203) is adjusted (reduced/increased), the quantity switch point is automatically and dynamically adjusted/tracked (e.g. with a new batching quantity changing from 10 to 20 liters, the quantity switch point is adjusted from 7 liters to 14 liters). In other words, the existing value data is tracked as a percentage of the altered batching quantity.

10.2.3 Examples of setting parameters for batching processes

The two examples in the next section clearly show the effect of different entries and options in the function group.

Example 1

The first example explains the parameter setting of various functions for carrying out batching and illustrates how functions are affected when the batching quantity is changed.

The following batching is to take place:

- 2-stage batching with a batching quantity of 10 kg in total.
- Coarse batching quantity of 8 kg. Valve 2 opens at the start of the batching and closes when 8 kg is achieved.
- Fine batching of 2 kg. Valve 1 opens at the start of the batching and closes (automatically) when the batching quantity (10 kg) is achieved.
- Once 9 kg have been batched a batching progress message should be generated.
- Value-input should be entered.

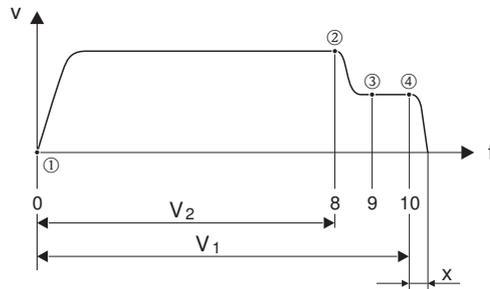

A0004670

v = Flow velocity [m/s]

t = Time

V_1 = Valve 1 open

V_2 = Valve 2 open

①= Start batching/coarse batching, valves 1 (7220) and 2 (7222) open

②= Valve 2 (7223) closes, coarse batching quantity achieved

③= Batching progress message (7243)

④= Valve 1 (7221) closes, end of batching

x = After run quantity

The following parameter settings must be made:

- Select the unit for batching:

Function UNIT MASS (0401) → 17 = kg (kilogram)

- Select the measured variable for batching:

Function ASSIGN BATCH VARIABLE (7202) → 149 = MASS FLOW

- Enter the batching quantity:

Function BATCH QUANTITY (7203) → 149 = 10 [kg]

- Select the entry format:

Function BATCH STAGES (7208) → 153 = 2-stage

- Select the entry format:

Function INPUT FORMAT (7209) → 153 = VALUE-INPUT

- Quantity data for when the first valve should open:

Function OPEN VALVE 1 (7220) → 154 = 0 [kg]

(valve 1 closes automatically when the batching quantity is achieved = 10 [kg], display in function CLOSE VALVE 1 (7221) → 154)

- Quantity data for when the second valve should open:
Function OPEN VALVE 2 (7224) → 155 = 0 [kg]
- Quantity data for when the second valve should close:
Function CLOSE VALVE 2 (7223) → 155 = 8 [kg]
- Quantity data for when the message should be generated:
Function PROGRESS NOTE (7243) → 161 = 9 [kg]

Example 1 a

Batching specifications identical to those in example 1, however the new batching quantity is 20 kg and the message should be generated once 18 kg are batched.

The following parameters must be set **manually**:

- Enter the new batching quantity:
Function BATCH QUANTITY (7203) → 149 = 20 [kg]
- New quantity data for when the message should be generated:
Function PROGRESS NOTE (7243) → 161 = 18 [kg]

The following functions are **automatically** adjusted to suit the new batching quantity:

- Function OPEN VALVE 1 = 0 [kg]
- Function OPEN VALVE 2 = 0 [kg]
- Function CLOSE VALVE 2 = 16 [kg]

Example 2

The second example explains the parameter settings of the various functions for batching with the entry format in % for the switch points of the valves.

The following batching is to take place:

- 2-stage batching with a batching quantity of 15 kg in total.
- Coarse batching quantity from 3 to 12 kg. Valve 2 opens when 20% (3 kg) of the batching quantity is achieved and closes when 80% (12 kg) is achieved.
- Valve 1 opens at the start of the batching and closes (automatically) when the batching quantity (15 kg) is achieved.
- %-input should be entered.

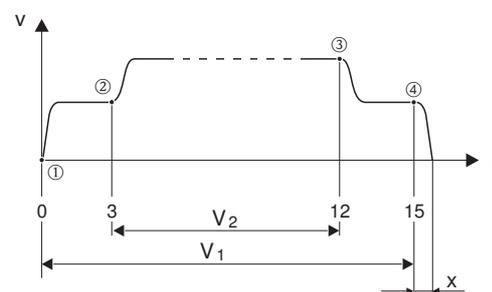

A0004684

v = Flow velocity [m/s]

t = Time

V_1 = Valve 1 open

V_2 = Valve 2 open

① = Start batching, valve 1 (7220) opens

② = Valve 2 (7222) opens, coarse batching quantity starts

③ = Valve 2 (7223) closes, coarse batching quantity achieved

④ = Valve 1 (7221) closes, end of batching

x = After run quantity

The following parameter settings must be made:

- Select the unit for batching:
Function UNIT MASS (0401) →  17 = kg (kilogram)

- Select the measured variable for batching:
Function ASSIGN BATCH VARIABLE (7202) →  149 = MASS FLOW

- Enter the batching quantity:
Function BATCH QUANTITY (7203) →  149 = 15 [kg]

- Select the entry format:
Function BATCH STAGES (7208) →  153 = 2-stage

- Select the entry format:
Function INPUT FORMAT (7209) →  153 = %-INPUT

- Percentage data for when the first valve should open:
Function OPEN VALVE 1 (7220) →  154 = 0 [%]
(Valve 1 closes automatically when the batching quantity is achieved = 15 [kg], display in function CLOSE VALVE 1 (7221) →  154)

- Percentage data for when the second valve should open:
Function OPEN VALVE 2 (7224) →  155 = 20 [%] corresponds to 3 kg

- Percentage data for when the second valve should close:
Function CLOSE VALVE 2 (7223) →  155 = 80 [%] corresponds to 12 kg

Example 2 a

Batching specifications identical to those in example 1, however the new batching quantity is 45 kg.

The following parameters must be set **manually** :

- Enter the new batching quantity:
Function BATCH QUANTITY (7203) →  149 = 45 [kg]

The following functions are **automatically** adjusted to suit the new batching quantity:

- Function OPEN VALVE 1 = 0 [%]

- Function OPEN VALVE 2 = 20 [%] corresponds to 9 kg

- Function CLOSE VALVE 2 = 80 [%] corresponds to 36 kg

10.2.4 Function group SUPERVISION

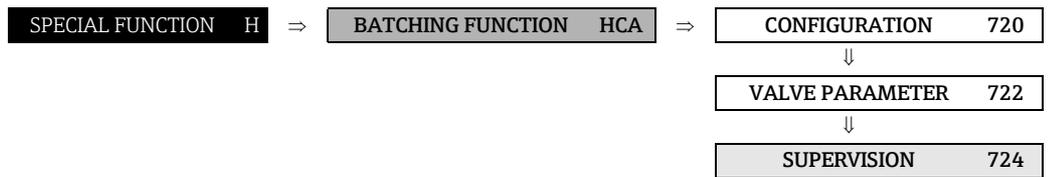

Function description	
SPECIAL FUNCTION → BATCHING FUNCTION → SUPERVISION	
MAXIMUM BATCHING TIME (7240)	<p>Use this function to specify a maximum batching time. All valves close once the specified batching time elapses, (see functions CLOSE VALVE 1...2, see → 154 ff.).</p> <p>This function can be used for safety reasons, for example, to ensure all batching valves close in the event of a system fault.</p> <p>User input: 0...30000 s</p> <p>Factory setting: 0 s (= deactivated)</p> <p> Caution!</p> <ul style="list-style-type: none"> ▪ When the batching quantity is adjusted (reduced/increased), (see function BATCH QUANTITY (7203) on → 149) there is no automatic adjustment, i.e. this value must be determined again and reentered, (see also fault message # 471 in the Operating Instructions <i>Proline Promass 83</i>, BA 059D/06/en, Troubleshooting Chapter). ▪ Batching (START) is not possible when the fault message is active! <p> Note!</p> <ul style="list-style-type: none"> ▪ The function is not active if you enter 0 s (factory setting). ▪ This means that the batching valves are not closed by means of this function. ▪ As a factory setting, this function is assigned a fault message. This appears for 60 seconds. The fault message can be acknowledged earlier by changing a batching function. ▪ If this function is intended more for general monitoring purposes or if there is a short time lapse between two batching processes, it is advisable to assign this function to a notice message, (see function ERROR CATEGORY on → 179). However, while the notice message is active (60 seconds) the next batching can be started and the notice message is acknowledged. ▪ This function can be output via the switch output.

Function description	
SPECIAL FUNCTION → BATCHING FUNCTION → SUPERVISION	
MIN. BATCHING QUANTITY (7241)	<p>Use this function to specify a minimum batching quantity. A message is generated if the minimum batching quantity was not achieved by the time batching ends (e.g. if after run mode is active). The quantity value is entered as a % or as an absolute value, depending on the option in the function INPUT FORMAT (7209).</p> <p>Application: Message stating that underbatching is present (e.g. the contents of the containers does not correspond to the quantity declared).</p> <p>User input: 0 to max. value or 0 to 100% (related to the batch quantity)</p> <p>Factory setting: 0 [unit] (= deactivated)</p> <p> Caution!</p> <ul style="list-style-type: none"> ▪ When the batching quantity is adjusted (reduced/increased), (see function BATCH QUANTITY (7203) on →  149), there is no automatic adjustment, i.e. this value must be determined again and reentered (see also the fault message # 472 in the Operating Instructions <i>Proline Promass 83</i>, BA 059D/06/en, Troubleshooting Chapter). ▪ Batching (START) is not possible when the fault message is active! <p> Note!</p> <ul style="list-style-type: none"> ▪ The function is not active if you enter 0 (factory setting). ▪ As a factory setting, this function is assigned a fault message. This appears for 60 seconds. The fault message can be acknowledged earlier by changing a batching function. ▪ If this function is intended more for general monitoring purposes or if there is a short time lapse between two batching processes, it is advisable to assign this function to a notice message, (see function ERROR CATEGORY on →  179). However, while the notice message is active (60 seconds) the next batching can be started and the notice message is acknowledged. ▪ This function can be output via the switch output.

Function description	
SPECIAL FUNCTION → BATCHING FUNCTION → SUPERVISION	
MAX. BATCHING QUANTITY (7242)	<p>Use this function to specify a maximum batching quantity. If the maximum batching quantity is exceeded during batching, all valves are closed, batching is stopped and a message is generated. The quantity value is entered as a % or as an absolute value, depending on the option in the function INPUT FORMAT (7209).</p> <p>Application: To avoid overbatching and thus prevent critical situations caused by fluid overflow arising in the plant, (e.g. plant standstill caused by safety level switches being triggered, contamination, product loss, etc.).</p> <p>User input: 0...2 x max. value or 0...200% (related to the batching quantity)</p> <p>Factory setting: 0 [unit] (= deactivated)</p> <p> Caution!</p> <ul style="list-style-type: none"> ▪ When the batching quantity is adjusted (reduced/increased), (see function BATCH QUANTITY (7203) on → 149), there is no automatic adjustment, i.e. this value must be determined again and reentered (see also the fault message # 472 in the Operating Instructions <i>Proline Promass 83</i>, BA 059D/06/en, Troubleshooting Chapter). ▪ Batching (START) is not possible when the fault message is active! <p> Note!</p> <ul style="list-style-type: none"> ▪ The function is not active if you enter 0 (factory setting). ▪ As a factory setting, this function is assigned a fault message. This appears for 60 seconds. The fault message can be acknowledged earlier by changing a batching function. ▪ If this function is intended more for general monitoring purposes or if there is a short time lapse between two batching processes, it is advisable to assign this function to a notice message, (see function ERROR CATEGORY on → 179). However, while the notice message is active (60 seconds) the next batching can be started and the notice message is acknowledged. ▪ This function can be output via the switch output.
PROGRESS NOTE (7243)	<p>Use this function to define a batching quantity at which a message should be generated. When the specified batching quantity is achieved, the message is generated and signaled via the output.</p> <p>The quantity value is entered as a % or as an absolute value, depending on the option in the function INPUT FORMAT (7209).</p> <p>Application: For longer batching processes when preparing or taking measures related to production (e.g. preparing to replace container, etc.).</p> <p>User input: 0 to max. value or 0 to 100% (related to the batch quantity)</p> <p>Factory setting: 0 [unit] (= deactivated)</p> <p> Caution!</p> <p>When the batching quantity is adjusted (reduced/increased), (see function BATCH QUANTITY (7203) on → 149), there is no automatic adjustment, i.e. this value must be determined again and reentered, (see also notice message # 473 in the Operating Instructions <i>Proline Promass 83</i>, BA 059D/06/en, Troubleshooting Chapter).</p> <p> Note!</p> <ul style="list-style-type: none"> ▪ The function is not active if you enter 0 (factory setting). ▪ This function can be output via the switch output. ▪ The batching progress message remains active until batching ends.

Function description	
SPECIAL FUNCTION → BATCHING FUNCTION → SUPERVISION	
MAX. FLOW (7244)	<p>A maximum flow value can be specified in this function. The batching process is aborted and all the valves are closed if the specified flow value is overshoot.</p> <p>Application: This function can be used for safety reasons, for example, to ensure all batching valves close in the event of a system fault.</p> <p>User input: 5-digit floating-point number</p> <p>Factory setting: 0 [unit] (= deactivated)</p> <p> Note!</p> <ul style="list-style-type: none"> ▪ The appropriate unit is taken depending on the process variable selected in the ASSIGN BATCH VARIABLE parameter and the unit configured in the SYSTEM UNITS function group. ▪ The function is not active if you enter 0 (factory setting). ▪ If the batching process is aborted because the specified flow value is overshoot, the parameter BATCH COUNTER is not incremented. ▪ New error message > MAX. FLOW with the error number #474. The error message is output automatically after 60 s. <p>In the function ASSIGN PROCESS ERROR (8002), you can use the ERROR CATEGORY (8003) to define whether this should be treated as a fault or notice message. Factory setting = FAULT MESSAGE</p>

10.2.5 Function group OPERATION

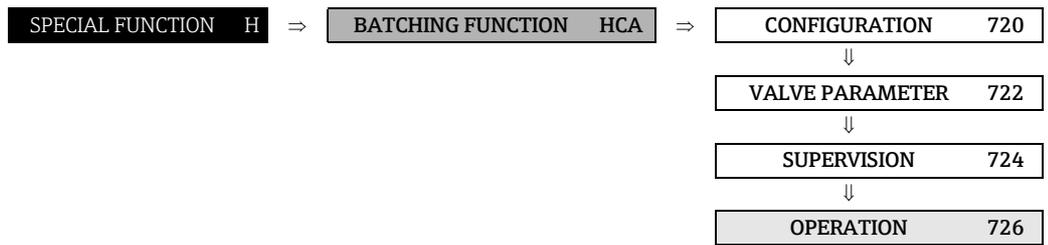

Function description	
SPECIAL FUNCTION → BATCHING FUNCTION → OPERATION	
BATCH PROCEDURE (7260)	<p>Use this function to control a batching process. The batching can be started manually or a batching already running can be interrupted or stopped at any time.</p> <p>Options: STOP (Stop batching) START (Start batching) HOLD (Interrupt batching) GO ON (Continue batching)</p> <p>Factory setting: STOP</p> <p> Note!</p> <ul style="list-style-type: none"> ▪ This function can also be controlled via the status input, (see function ASSIGN STATUS INPUT (5000) on →  114). ▪ If the information line has been assigned to BATCHING MENU (see →  51), the application-specific functions of the minus key (START-STOP) and the plus key (HOLD-GO ON / batching specification) are defined locally. In this way, a direct batching control station is available locally at the measuring device by means of the user interface (not access-protected). ▪ In the event of a fault: <ul style="list-style-type: none"> – during the batching process, the batching is canceled (STOP) and the local display alternates between displaying the batching menu and the fault message. ▪ If the positive zero return is activated, (see →  134): <ul style="list-style-type: none"> – during the batching process, the batching is canceled (STOP). – during a pause in the batching (option HOLD), the batching cannot be restarted, (see also notice messages # 571 and # 572 in the Operating Instructions <i>Proline Promass 83</i>, BA 059D/06/en, Chapter Troubleshooting).
BATCH UPWARDS (7261)	<p>In this function the batching progress can be read upwards, i.e. starting at 0 the quantity displayed increases until the batching process is complete.</p> <p>Display: Floating-point number incl. unit</p> <p> Note! The value of this function can be output via the current output.</p>
BATCH DOWNWARDS (7262)	<p>In this function the batching progress can be read downwards, i.e. starting from the batching quantity, the quantity displayed decreases until the batching process is complete.</p> <p>Display: Floating-point number incl. unit</p> <p> Note! The value of this function can be output via the current output.</p>

Function description SPECIAL FUNCTION → BATCHING FUNCTION → OPERATION	
BATCH COUNTER (7263)	Use this function to display the number of batchings carried out. Display: max. 7-digit floating-point number Factory setting: 0  Note! <ul style="list-style-type: none"> ▪ The batching quantity totalizer can be reset to 0 via the function RESET SUM/COUNTER (7265). ▪ This function is reset to 0 (zero) if a different batching specification is selected in the function BATCH SELECTOR (7200).
BATCH SUM (7264)	Use this function to display the effective overall total of all the batchings carried out. Display: max. 7-digit floating-point number [unit] Factory setting: 0 [unit]  Note! <ul style="list-style-type: none"> ▪ E.g. in 2-stage batching the effective overall total is calculated from the coarse batching quantity, fine batching quantity and after run quantity. ▪ The total batching quantity can be reset to 0 via the function RESET SUM/COUNTER (7265). ▪ This function is reset to 0 (zero) if a different batching specification is selected in the function BATCH SELECTOR (7200).
RESET SUM/COUNTER (7265)	Use this function to reset the batch counter and the batch sum to zero. User input: NO YES Factory setting: NO  Note! The batch counter and the batch sum can also be reset via the batching menu (information line on the local display).

10.2.6 Function group INFORMATION

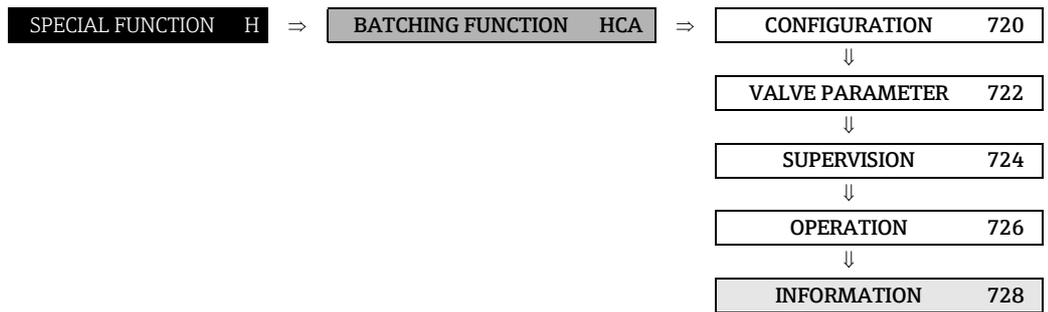

Function description	
SPECIAL FUNCTION → BATCHING FUNCTION → INFORMATION	
INTERNAL SWITCH POINT VALVE 1 (7280)	<p>Use this function to display the internal switch point of valve 1 (siehe Funktion CLOSE VALVE 1 (7221) auf Seite 154). The value displayed takes the fixed correction quantity and / or the calculated after run quantity into account.</p> <p>Display: max. 7-digit floating-point number [unit]</p> <p> Note! The appropriate unit is taken from the function group SYSTEM UNITS (ACA), (see →  17).</p>
DRIP QUANTITY (7281)	<p>Displays the after run calculated (averaged) internally. The value displayed can be overwritten in this function and the after run can thus be adjusted. The after run quantity is used to optimize the internal switch point of valve 1.</p> <p>User input: 0...quantity [unit]</p> <p> Note! The after run, entered in this function, is only used for the first batching process. For the second and following batching processes, the internally calculated after run will be used again. The appropriate unit is taken from the function group SYSTEM UNITS (ACA), (see →  17).</p> <p>Factory setting: 0 [unit]</p>
VALVE 1 CLOSING TIME (7282)	<p>Use this function to display the valve closing time calculated internally.</p> <p>Display: max. 7-digit floating-point number [ms]</p> <p> Note!</p> <ul style="list-style-type: none"> ▪ The valve closing time is the period between the switch point of valve 1 and the first undershooting of the low flow cut off. ▪ The data can only be taken as a general trend.

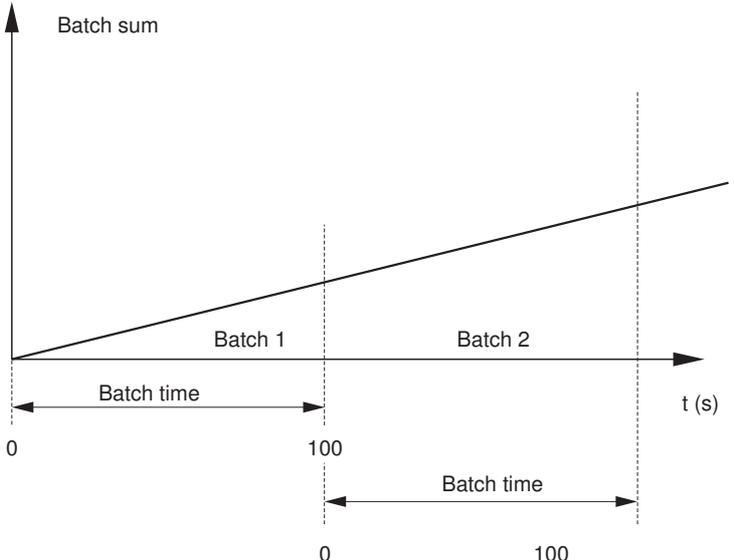
Function description	
SPECIAL FUNCTION → BATCHING FUNCTION → INFORMATION	
BATCHING TIME (7283)	<p>In this function, you can read the batching time for the current or completed batching process, i.e. starting at 0 seconds, the time displayed increases until the batching process is complete.</p> <p>Application: This BATCHING TIME refers to the batch quantity determined in the BATCH SUM function for the current or last batching process.</p>  <p style="text-align: right; font-size: small;">A0001170-en</p> <p>Display: max. 7-digit floating-point number</p> <p> Note!</p> <ul style="list-style-type: none"> ■ Behavior when controlling batching process via function BATCH PROCEDURE: <ul style="list-style-type: none"> - STOP ⇒ BATCHING TIME is not reset and stays at the current value. - START ⇒ BATCHING TIME is reset and starts with the value 0 - HOLD ⇒ BATCHING TIME is not reset and stays at the current value. - GO ON ⇒ BATCHING TIME is not reset and continues updating on the basis of the last time value ■ The BATCHING TIME is also updated during the batching process

10.3 Group ADVANCED DIAGNOSIS

10.3.1 Function group CONFIGURATION

SPECIAL FUNCTION H ⇒

ADVANCED DIAGNOSIS HEA ⇒

CONFIGURATION 740

Function description	
SPECIAL FUNCTION → ADVANCED DIAGNOSIS → CONFIGURATION	
REFERENCE CONDITION USER (7401)	<p>Use this function to start determining the user reference status. The following values are determined:</p> <ul style="list-style-type: none"> ▪ MASS FLOW ▪ DENSITY ▪ REFERENCE DENSITY ▪ TEMPERATURE ▪ TUBE DAMPING ▪ ELECTRODYNAMIC SENSORS ▪ OPERATING FREQUENCY FLUCTUATION ▪ TUBE DAMPING FLUCTUATION <p>Options: CANCEL START</p> <p>Factory setting: CANCEL</p>
SELECT REFERENCE CONDITION (7402)	<p>Use this function to select the reference status which should be used to compare the advanced diagnosis parameters (see function ACQUISITION MODE (7410) on → 168).</p> <p>Options: FACTORY USER</p> <p>Factory setting: FACTORY</p>
WARNING MODE (7403)	<p>Use this function to determine whether a warning should be generated when there is a deviation between the reference status (FACTORY or USER, see function SELECT REFERENCE CONDITION (7402)) and the current measuring values. The values of the following functions are compared to the reference status :</p> <ul style="list-style-type: none"> ▪ MASS FLOW (7421) ▪ DENSITY (7431) ▪ REFERENCE DENSITY (7441) ▪ TEMPERATURE (7451) ▪ TUBE DAMPING (7461) ▪ ELECTRODYNAMIC SENSORS (7471) ▪ OPERATING FREQUENCY FLUCTUATION (7481) ▪ TUBE DAMPING FLUCTUATION (7491) <p>Options: OFF ON</p> <p>Factory setting: OFF</p>

10.3.2 Function group ACQUISITION

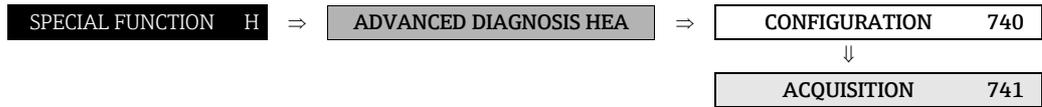

Function description SPECIAL FUNCTION → ADVANCED DIAGNOSIS → ACQUISITION	
ACQUISITION MODE (7410)	<p>Use this function to specify whether the advanced diagnosis parameters should be determined on a periodical or single-shot basis.</p> <p>Options: OFF PERIODICAL SINGLE SHOT</p> <p>Factory setting: OFF</p> <p> Note! See the Chapter on “Commissioning” in the Operating Instructions <i>Proline Promass 83</i>, BA 059D/06/en for more information on advanced diagnosis.</p>
ACQUISITION PERIOD (7411)	<p> Note! This function is not available unless PERIODICAL was selected in the ACQUISITION MODE function (7410).</p> <p>Use this function to specify the time interval after which the advanced diagnosis parameters should be taken. The time interval starts with the confirmation of the input.</p> <p>User input: 0...99999 s</p> <p>Factory setting: 3600 s</p> <p> Note! A reference status must be defined prior to determining the diagnosis parameters, see function SELECT REFERENCE CONDITION (7402).</p>
ACQUISITION DO (7412)	<p> Note! This function is not available unless SINGLE SHOT was selected in the ACQUISITION MODE function (7410).</p> <p>Use this function to start determining the advanced diagnosis parameters on a single-shot basis.</p> <p>Options: START – CANCEL</p> <p>Factory setting: CANCEL</p> <p> Note! A reference status must be defined prior to determining the diagnosis parameters, see function SELECT REFERENCE CONDITION (7402).</p>
RESET HISTORY (7413)	<p>Use this function to delete all history values.</p> <p>Options: YES – NO</p> <p>Factory setting: NO</p>

10.3.3 Function group MASS FLOW

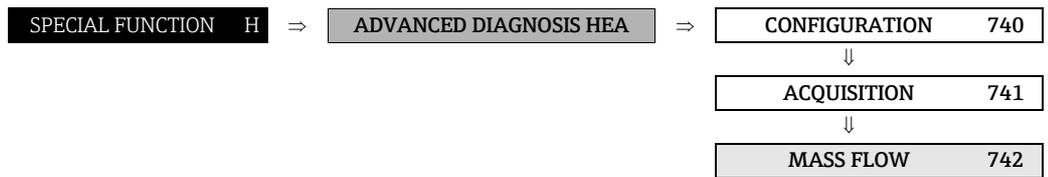

Function description	
SPECIAL FUNCTION → ADVANCED DIAGNOSIS → MASS FLOW	
<p> Note! The appropriate unit is taken from the function UNIT MASS FLOW (0400) (see →  17).</p>	
REFERENCE VALUES MASS FLOW (7420)	<p>The reference value for the mass flow appears on the display.</p> <p>Display: 5-digit floating-point number, including unit and sign</p>
MASS FLOW (7421)	<p>The measured mass flow appears on the display.</p> <p>Display: 5-digit floating-point number, including unit and sign</p>
MINIMUM VALUE (7422)	<p>The lowest mass flow value since the saved values were last reset appears on the display.</p> <p>Display: 5-digit floating-point number, including unit and sign</p>
MAXIMUM VALUE (7423)	<p>The highest mass flow value since the saved values were last reset appears on the display.</p> <p>Display: 5-digit floating-point number, including unit and sign</p>
MASS FLOW HISTORY (7424)	<p>The last ten mass flow values since the saved values were last reset appear on the display.</p> <p>Display: 5-digit floating-point number, including unit and sign</p>
MASS FLOW DEVIATION (7425)	<p>This function displays deviation between the measured mass flow and the reference values (FACTORY or USER), see →  167, selected in the function SELECT REFERENCE CONDITION (7402).</p> <p>Display: 5-digit floating-point number, including unit and sign</p>
WARNING LEVEL (7426)	<p> Note! This function is not available unless ON was selected in the WARNING MODE function (7403).</p> <p>Use this function to specify a limit value for the mass flow. A notice message is generated if the limit value is exceeded.</p> <p>User input: 0...99999 [Mass flow unit]</p> <p>Factory setting: 90000 kg/h</p>

10.3.4 Function group DENSITY

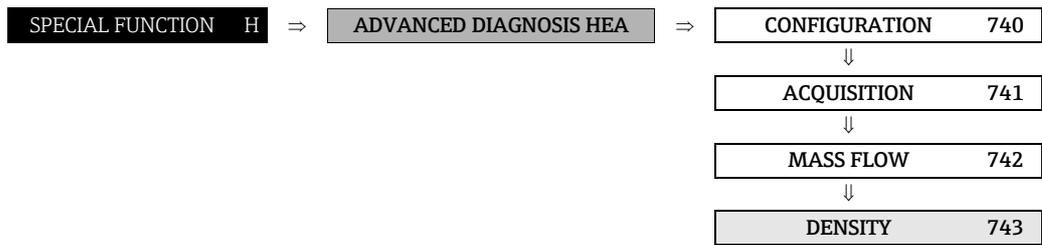

Function description	
SPECIAL FUNCTION → ADVANCED DIAGNOSIS → DENSITY	
<p> Note! The appropriate unit is taken from the function UNIT DENSITY (0420) (see →  20).</p>	
REFERENCE VALUE DENSITY (7430)	<p>The reference value for the density appears on the display.</p> <p>Display: 5-digit floating-point number, incl. units</p>
DENSITY (7431)	<p>The measured density appears on the display.</p> <p>Display: 5-digit floating-point number, incl. units</p>
MINIMUM VALUE (7432)	<p>The lowest density value since the saved values were last reset appears on the display.</p> <p>Display: 5-digit floating-point number, incl. units</p>
MAXIMUM VALUE (7433)	<p>The highest density value since the saved values were last reset appears on the display.</p> <p>Display: 5-digit floating-point number, incl. units</p>
DENSITY HISTORY (7434)	<p>The last ten density values since the saved values were last reset appear on the display.</p> <p>Display: 5-digit floating-point number, incl. units</p>
DENSITY DEVIATION (7435)	<p>This function displays the deviation between the measured density and the reference values (FACTORY or USER), see →  167, selected in the function SELECT REFERENCE CONDITION (7402).</p> <p>Display: 5-digit floating-point number, incl. units</p>
WARNING LEVEL (7436)	<p> Note! This function is not available unless ON was selected in the WARNING MODE function (7403).</p> <p>Use this function to specify a limit value for the density. A notice message is generated if the limit value is exceeded.</p> <p>User input: 0...99999 [%]</p> <p>Factory setting: 100%</p>

10.3.5 Function group REFERENCE DENSITY

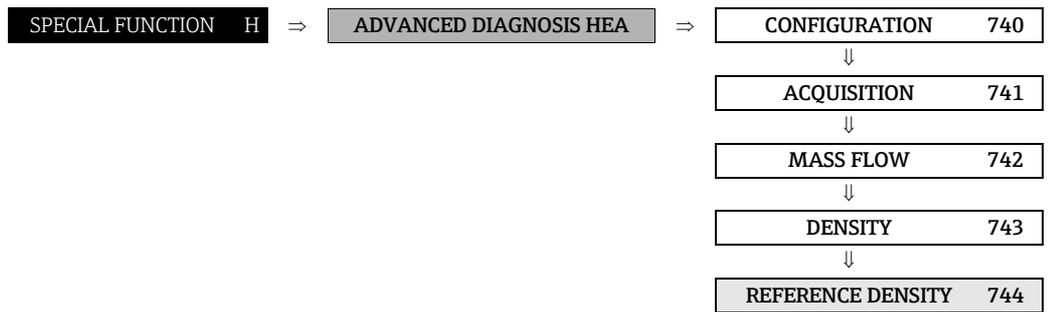

Function description	
SPECIAL FUNCTION → ADVANCED DIAGNOSIS → REFERENCE DENSITY	
<p> Note! The appropriate unit is taken from the function UNIT REFERENCE DENSITY (0421) (→  20).</p>	
REFERENCE VALUE REFERENCE DENSITY (7440)	<p>The reference value for the reference density appears on the display.</p> <p>Display: 5-digit floating-point number, incl. units</p>
REFERENCE DENSITY (7441)	<p>The measured reference density appears on the display.</p> <p>Display: 5-digit floating-point number, incl. units</p>
MINIMUM VALUE (7442)	<p>The lowest reference density value since the saved values were last reset appears on the display.</p> <p>Display: 5-digit floating-point number, incl. units</p>
MAXIMUM VALUE (7443)	<p>The highest reference density value since the saved values were last reset appears on the display.</p> <p>Display: 5-digit floating-point number, incl. units</p>
REFERENCE DENSITY HISTORY (7444)	<p>The last ten reference density values since the saved values were last reset appear on the display.</p> <p>Display: 5-digit floating-point number, incl. units</p>
REFERENCE DENSITY DEVIATION (7445)	<p>This function displays the deviation between the measured reference density and the reference values (FACTORY or USER), see →  167, selected in the function SELECT REFERENCE CONDITION (7402).</p> <p>Display: 5-digit floating-point number, incl. units</p>
WARNING LEVEL (7446)	<p> Note! This function is not available unless ON was selected in the WARNING MODE function (7403).</p> <p>Use this function to specify a limit value for the reference density. A notice message is generated if the limit value is exceeded.</p> <p>User input: 0...99999 [%]</p> <p>Factory setting: 100%</p>

10.3.6 Function group TEMPERATURE



Function description	
SPECIAL FUNCTION → ADVANCED DIAGNOSIS → TEMPERATURE	
<p> Note! The appropriate unit is taken from the function UNIT TEMPERATURE (0422) (see → 21).</p>	
REFERENCE VALUE TEMPERATURE (7450)	<p>The reference value for the temperature appears on the display.</p> <p>Display: 5-digit floating-point number, including unit and sign</p>
TEMPERATURE (7451)	<p>The currently measured temperature appears on the display.</p> <p>Display: 5-digit floating-point number, including unit and sign</p>
MINIMUM VALUE (7452)	<p>The lowest temperature value since the saved values were last reset appears on the display.</p> <p>Display: 5-digit floating-point number, including unit and sign</p>
MAXIMUM VALUE (7453)	<p>The highest temperature value since the saved values were last reset appears on the display.</p> <p>Display: 5-digit floating-point number, including unit and sign</p>
TEMPERATURE HISTORY (7454)	<p>The last ten temperature values since the saved values were last reset appear on the display.</p> <p>Display: 5-digit floating-point number, including unit and sign</p>
TEMPERATURE DEVIATION (7455)	<p>This function displays the deviation between the currently measured temperature and the reference values (FACTORY or USER), see → 167, selected in the function SELECT REFERENCE CONDITION (7402).</p> <p>Display: 5-digit floating-point number, including unit and sign</p>
WARNING LEVEL (7456)	<p> Note! This function is not available unless ON was selected in the WARNING MODE function (7403).</p> <p>Use this function to specify a limit value for the temperature. A notice message is generated if the limit value is exceeded.</p> <p>User input: 0...99999 °C</p> <p>Factory setting: 100 °C</p>

10.3.7 Function group TUBE DAMPING

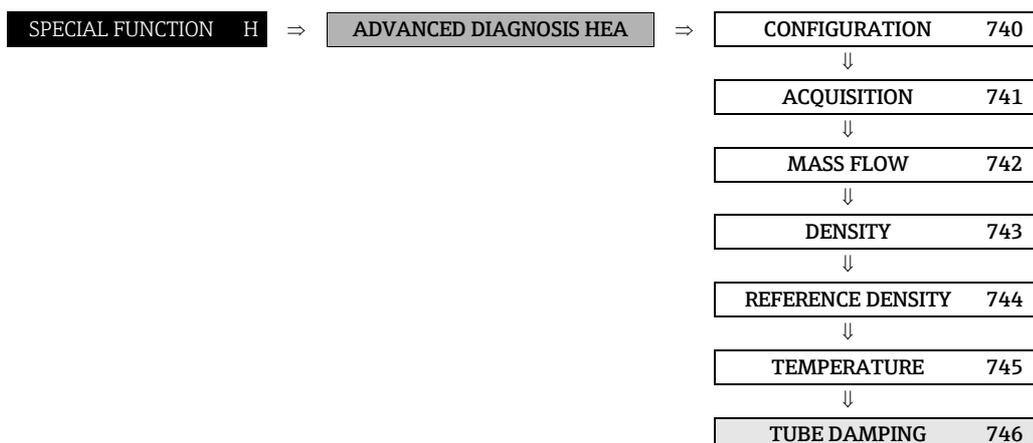

Function description	
SPECIAL FUNCTION → ADVANCED DIAGNOSIS → TUBE DAMPING	
REFERENCE VALUE TUBE DAMPING (7460)	The reference value for tube damping appears on the display. Display: 5-digit floating-point number
TUBE DAMPING (7461)	The measured tube damping appears on the display. Display: 5-digit floating-point number
MINIMUM VALUE (7462)	The lowest tube damping value since the saved values were last reset appears on the display. Display: 5-digit floating-point number
MAXIMUM VALUE (7463)	The highest tube damping value since the saved values were last reset appears on the display. Display: 5-digit floating-point number
TUBE DAMPING HISTORY (7464)	The last ten tube damping values since the saved values were last reset appears on the display. Display: 5-digit floating-point number
TUBE DAMPING DEVIATION (7465)	This function displays the deviation between the measured tube damping and the reference values (FACTORY or USER), see → 167, selected in the function SELECT REFERENCE CONDITION (7402). Display: 5-digit floating-point number
WARNING LEVEL (7466)	 Note! This function is not available unless ON was selected in the WARNING MODE function (7403). Use this function to specify a limit value for tube damping. A notice message is generated if the limit value is exceeded. User input: 0...99999 [%] Factory setting: 1000%

10.3.8 Function group ELECTRODYNAMIC SENSORS

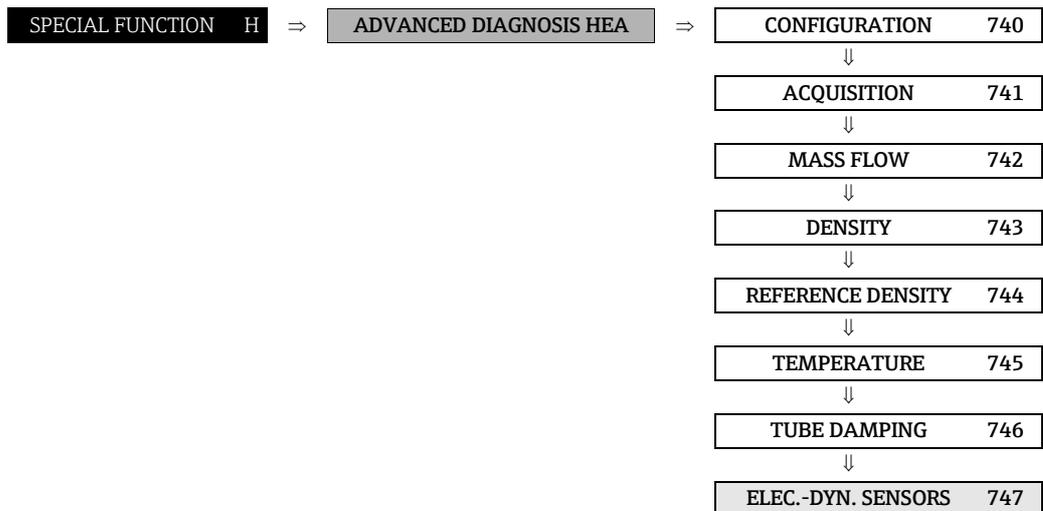

Function description	
SPECIAL FUNCTION → ADVANCED DIAGNOSIS → ELECTRODYNAMIC SENSORS	
REFERENCE VALUE ELECTRODYNAMIC SENSORS (7470)	The reference value for the electrodynamic sensors appears on the display. Display: 5-digit floating-point number
ELECTRODYNAMIC SENSORS (7471)	The measuring values for the electrodynamic sensors appear on the display. Display: 5-digit floating-point number
MINIMUM VALUE (7472)	The lowest value of the electrodynamic sensors since the saved values were last reset appears on the display. Display: 5-digit floating-point number
MAXIMUM VALUE (7473)	The highest value of the electrodynamic sensors since the saved values were last reset appears on the display. Display: 5-digit floating-point number
ELECTRODYNAMIC SENSOR HISTORY (7474)	The last ten values of the electrodynamic sensors since the saved values were last reset appear on the display. Display: 5-digit floating-point number
ELECTRODYNAMIC SENSOR DEVIATION (7475)	This function displays the deviation between the measuring values for the electrodynamic sensors and the reference values (FACTORY or USER), see → 167, selected in the function SELECT REFERENCE CONDITION (7402) is displayed. Display: 5-digit floating-point number
WARNING LEVEL (7476)	 Note! This function is not available unless ON was selected in the WARNING MODE function (7403). Use this function to specify a limit value for the electrodynamic sensors. A notice message is generated if the limit value is exceeded. User input: 0...99999 [%] Factory setting: 100%

10.3.9 Function group OPERATING FREQUENCY FLUCTUATION

SPECIAL FUNCTION H	⇒	ADVANCED DIAGNOSIS HEA	⇒	CONFIGURATION 740
				↓
				ACQUISITION 741
				↓
				MASS FLOW 742
				↓
				DENSITY 743
				↓
				REFERENCE DENSITY 744
				↓
				TEMPERATURE 745
				↓
				TUBE DAMPING 746
				↓
				ELEC.-DYN. SENSORS 747
				↓
				OPERATING FREQ. FLUCT. 748

Function description	
SPECIAL FUNCTION → ADVANCED DIAGNOSIS → OPERATING FREQUENCY FLUCTUATION	
REFERENCE VALUE OPERATING FREQUENCY FLUCTUATION (7480)	The reference value for the fluctuation of the operating frequency appears on the display. Display: 5-digit floating-point number, Hz
OPERATING FREQUENCY FLUCTUATION (7481)	The measured fluctuation of the operating frequency appears on the display. Display: 5-digit floating-point number, Hz
MINIMUM VALUE (7482)	The lowest value of the operating frequency fluctuation since the saved values were last reset appears on the display. Display: 5-digit floating-point number, Hz
MAXIMUM VALUE (7483)	The highest value of the operating frequency fluctuation since the saved values were last reset appears on the display. Display: 5-digit floating-point number, Hz
OPERATING FREQUENCY FLUCTUATION HISTORY (7484)	The last ten values of the operating frequency fluctuation since the saved values were last reset appear on the display. Display: 5-digit floating-point number, Hz
OPERATING FREQUENCY FLUCTUATION DEVIATION (7485)	This function displays the deviation between the measured deviation of the operating frequency and the reference values (FACTORY or USER) selected in the function SELECT REFERENCE CONDITION (7402) see → 167. Display: 5-digit floating-point number, Hz
WARNING LEVEL(7486)	 Note! This function is not available unless ON was selected in the WARNING MODE function (7403). Use this function to specify a limit value for the operating frequency fluctuation. A notice message is generated if the limit value is exceeded. User input: 0...99999 Hz Factory setting: 1000 Hz

10.3.10 Function group TUBE DAMPING FLUCTUATION

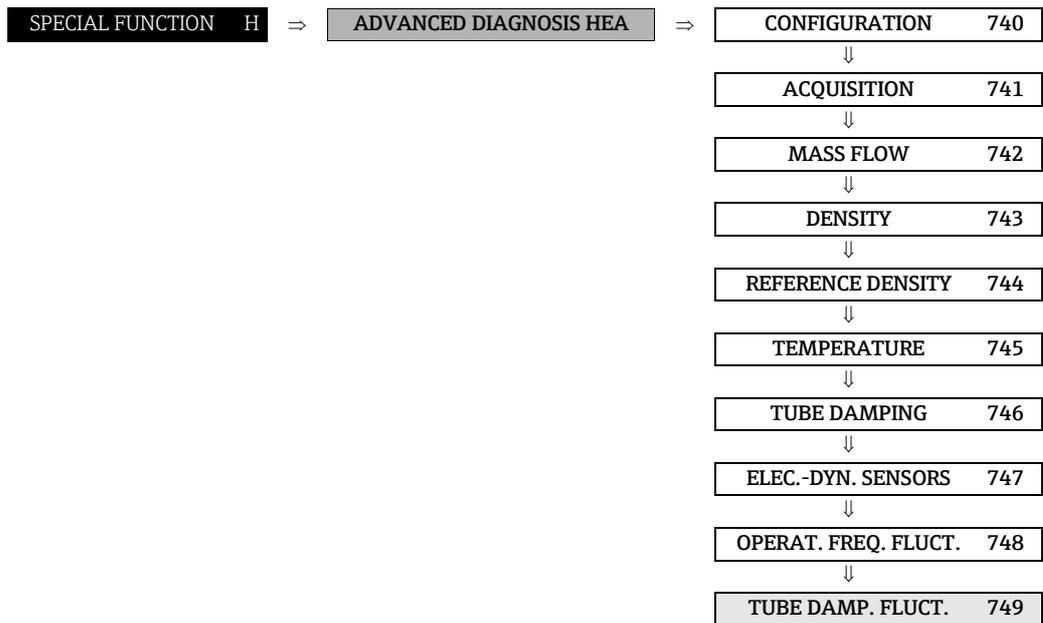

Function description	
SPECIAL FUNCTION → ADVANCED DIAGNOSIS → TUBE DAMPING FLUCTUATION	
REFERENCE VALUE TUBE DAMPING FLUCTUATION (7490)	The reference value for the fluctuation of the tube damping appears on the display. Display: 5-digit floating-point number
TUBE DAMPING FLUCTUATION (7491)	The measured fluctuation of the tube damping appears on the display. Display: 5-digit floating-point number
MINIMUM VALUE (7492)	The lowest value of the tube damping since the saved values were last reset appears on the display. Display: 5-digit floating-point number
MAXIMUM VALUE (7493)	The highest value of the tube damping fluctuation since the saved values were last reset appears on the display. Display: 5-digit floating-point number
TUBE DAMPING FLUCTUATION HISTORY (7494)	The last ten values of the tube damping fluctuation since the saved values were last reset appear on the display. Display: 5-digit floating-point number
TUBE DAMPING FLUCTUATION DEVIATION (7495)	This function displays the deviation between the measured deviation of the tube damping and the reference values (FACTORY or USER) selected in the function SELECT REFERENCE CONDITION (7402) see → 167. Display: 5-digit floating-point number

Function description	
SPECIAL FUNCTION → ADVANCED DIAGNOSIS → TUBE DAMPING FLUCTUATION	
WARNING LEVEL (7496)	<p> Note! This function is not available unless ON was selected in the WARNING MODE function (7403).</p> <p>Use this function to specify a limit value for the tube damping fluctuation. A notice message is generated if the limit value is exceeded.</p> <p>User input: 0...99999</p> <p>Factory setting: 1000</p>

Block	Groups	Function	Functions								
SUPERVISION	SYSTEM	CONFIGURATION	⇒ ASSIGN SYS. ERROR	⇒ ERROR CATEGORY	⇒ ASSIGN PROC. ERROR	⇒ ERROR CATEGORY	⇒ ACKNOWL. FAULTS	⇒ ALARM DELAY	⇒ REMOVE SW-OPTION	⇒ PERMANENT STORAGE	
		OPERATION	⇒ ACT. SYS. CONDITION	⇒ PREV. SYS. CONDITION	⇒ SIM. FAIL-SAFE MODE	⇒ SIM. MEASU-	⇒ VALUE SIM. MEASUR.	⇒ SYSTEM RESET	⇒ OPERATION HOURS		
	VERSION-INFO	DEVICE	⇒ DEVICE SOFTWARE								
		SENSOR	⇒ SERIAL NUMBER	⇒ SENSOR TYPE	⇒ SW REV. NO. S-DAT						
		AMPLIFIER	⇒ SW REV. NO. AMPLIFIER	⇒ SW REV. NO. T-DAT	⇒ LANGUAGE GROUP						
		F-CHIP	⇒ STATUS F-CHIP	⇒ SYSTEM OPTION	⇒ SW REV. NO F-CHIP						
		I/O MODULE	⇒ I/O MODULE TYPE	⇒ SW REV.-NO. I/O MODULE							
		I/O SUBMODULE 1	⇒ SUB-IN-/OUTPUT	⇒ SW REV. SUB-I/O							
		I/O SUBMODULE 2	⇒ SUB-IN-/OUTPUT	⇒ SW REV. SUB-I/O							
		I/O SUBMODULE 3	⇒ SUB-IN-/OUTPUT	⇒ SW REV. SUB-I/O							
I/O SUBMODULE 4	⇒ SUB-IN-/OUTPUT	⇒ SW REV. SUB-I/O									

11 Block SUPERVISION

11.1 Group SYSTEM

11.1.1 Function group CONFIGURATION

SUPERVISION J ⇒ SYSTEM JAA ⇒ CONFIGURATION 800

Function description SUPERVISION → SYSTEM → CONFIGURATION	
ASSIGN SYSTEM ERROR (8000)	<p>Use this function to view all system errors. By selecting a certain system error, its error category can be changed in the subsequent function ERROR CATEGORY (8001).</p> <p>Options: CANCEL List of system errors</p> <p> Note!</p> <ul style="list-style-type: none"> ▪ You can exit this function as follows: select "CANCEL" and confirm with <input type="checkbox"/>. ▪ A list of possible system errors is provided in the Operating Instruction Operating Instructions <i>Proline Promass 83</i>, BA00059D
ERROR CATEGORY (8001)	<p> Note!</p> <p>This function is only available if a system error has been selected in the function ASSIGN SYSTEM ERROR (8000).</p> <p>Use this function to define whether a system error triggers a notice message or a fault message. If you select FAULT MESSAGES, all outputs respond to an error in accordance with their defined error response patterns.</p> <p>Options: NOTICE MESSAGES (display only) FAULT MESSAGES (outputs and display)</p> <p> Note!</p> <p>Press the key <input type="checkbox"/> twice to call up the function ASSIGN SYSTEM ERROR (8000).</p>
ASSIGN PROCESS ERROR (8002)	<p>Use this function to view all process errors. By selecting an individual process error, its error category can be changed in the subsequent function ERROR CATEGORY (8003).</p> <p>Options: CANCEL List of process errors</p> <p> Note!</p> <ul style="list-style-type: none"> ▪ You can exit this function as follows: select "CANCEL" and confirm with <input type="checkbox"/>. ▪ A list of possible process errors is provided in the Operating Instruction Operating Instructions <i>Proline Promass 83</i>, BA00059D
ERROR CATEGORY (8003)	<p> Note!</p> <p>This function is only available if a process error has been selected in the function ASSIGN PROCESS ERROR (8002).</p> <p>Use this function to define whether a process error triggers a notice message or a fault message. If you select FAULT MESSAGES, all outputs respond to an error in accordance with their defined error response patterns.</p> <p>Options: NOTICE MESSAGES (display only) FAULT MESSAGES (outputs and display)</p> <p> Note!</p> <p>Press the key <input type="checkbox"/> twice to call up the function ASSIGN PROCESS ERROR (8002).</p>

Function description SUPERVISION → SYSTEM → CONFIGURATION	
ACKNOWLEDGE FAULTS (8004)	Use this function to define the measuring device's response to fault messages. Options: OFF The measuring device resumes normal operation when the fault is rectified. The fault message automatically disappears from the local display. ON The measuring device resumes normal operation when the fault is rectified. The fault message appears in the local display until it is acknowledged by pressing the  button. Factory setting: OFF
ALARM DELAY (8005)	Use this function to define a time span for which the criteria for an error have to be satisfied without interruption before a fault or notice message is generated. Depending on the setting and the type of error, this suppression acts on: <ul style="list-style-type: none"> ▪ Display ▪ Current output ▪ Frequency output ▪ Relay output ▪ Current input User input: 0...100 s (in steps of one second) Factory setting: 0 s  Caution! If this function is activated, fault and notice messages are delayed by the time corresponding to the setting before being transmitted to the higher-order controller (process controller, etc.). It is therefore imperative to check in advance in order to make sure whether a delay of this nature could affect the safety requirements of the process. If fault and notice messages may not be suppressed, a value of 0 seconds must be entered here.
REMOVE SW-OPTION (8006)	 Note! This function is only available if: <ul style="list-style-type: none"> ▪ The F-CHIP software options were saved beforehand ▪ The F-CHIP is not located on the I/O board of the measuring device Deletes all F-CHIP software options, such as batching, density functions, etc. Options: 0 = NO 1 = YES Factory setting: NO  Caution! If process variables which are only available via the F-CHIP software options are assigned to the local display or the outputs, these have to be reconfigured. If reconfiguration does not take place, the local display and the totalizer are set to the factory setting and the outputs are set to OFF.
PERMANENT STORAGE (8007)	This function indicates whether permanent storage of all parameters in the EEPROM has been switched on or off. Display: "OFF" or "ON" Factory setting: ON

11.1.2 Function group OPERATION

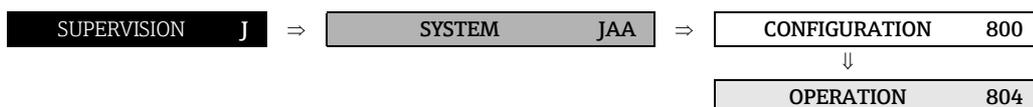

Function description	
SUPERVISION → SYSTEM → OPERATION	
ACTUAL SYSTEM CONDITION (8040)	<p>Use this function to check the present system condition.</p> <p>Display: “SYSTEM OK” or the fault / notice message with the highest priority.</p>
PREVIOUS SYSTEM CONDITION (8041)	<p>Use this function to view the fifteen most recent fault and notice messages since measuring last started.</p> <p>Display: The 15 most recent fault or notice messages.</p>
SIMULATION FAILSAFE MODE (8042)	<p>Use this function to set all inputs, outputs and totalizers to their defined failsafe modes, in order to check whether they respond correctly. During this time, the message “SIMULATION FAILSAFE MODE” appears on the display.</p> <p>Options: ON OFF</p> <p>Factory setting: OFF</p>
SIMULATION MEASURAND (8043)	<p>Use this function to set all inputs, outputs and totalizers to their defined flow-response modes, in order to check whether they respond correctly. During this time, the message “SIMULATION MEASURAND” appears on the display.</p> <p>Options: OFF MASS FLOW VOLUME FLOW CORRECTED VOLUME FLOW DENSITY REFERENCE DENSITY TEMPERATURE</p> <p>Factory setting: OFF</p> <p> Caution!</p> <ul style="list-style-type: none"> ▪ The measuring device cannot be used for measuring while this simulation is in progress. ▪ The setting is not saved if the power supply fails.
VALUE SIMULATION MEASURAND (8044)	<p> Note! The function is not visible unless the function SIMULATION MEASURAND (8043) is active.</p> <p>Use this function to define a freely selectable value (e.g. 12 m³/s). This is used to test the associated functions in the device itself and downstream signal loops.</p> <p>User input: 5-digit floating-point number [unit]</p> <p>Factory setting: 0 [unit]</p> <p> Caution!</p> <ul style="list-style-type: none"> ▪ The setting is not saved if the power supply fails. ▪ The appropriate unit is taken from the function group SYSTEM UNITS (ACA), (see →  17).

Function description SUPERVISION → SYSTEM → OPERATION	
SYSTEM RESET (8046)	<p>Use this function to perform a reset of the measuring system.</p> <p>Options: NO RESTART SYSTEM (restart without interrupting power supply)</p> <p>Factory setting: NO</p>
OPERATION HOURS (8048)	<p>The hours of operation of the device appear on the display.</p> <p>Display: Depends on the number of hours of operation elapsed: Hours of operation < 10 hours → display format = 0:00:00 (hr:min:sec) Hours of operation 10...10,000 hours → display format = 0000:00 (hr:min) Hours of operation > 10,000 hours → display format = 000000 (hr)</p>

11.2 Group VERSION-INFO

11.2.1 Function group DEVICE

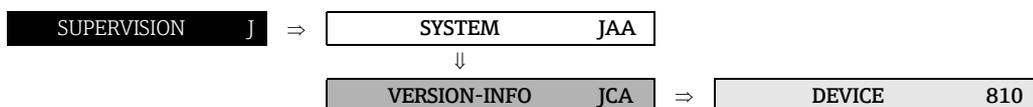

Function description	
SUPERVISION → VERSION-INFO → DEVICE	
DEVICE SOFTWARE (8100)	Displays the current device software version.

11.2.2 Function group SENSOR

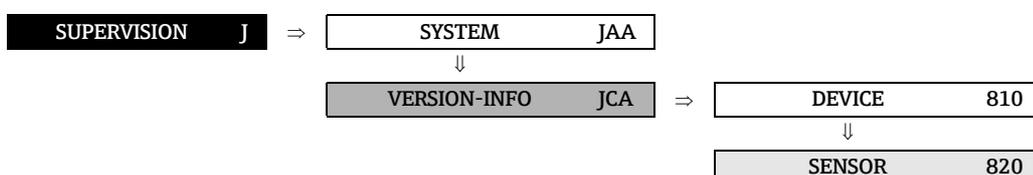

Function description	
SUPERVISION → VERSION-INFO → SENSOR	
SERIAL NUMBER (8200)	Use this function to view the serial number of the sensor.
SENSOR TYPE (8201)	Use this function to view the sensor type (e.g. Promass F).
SOFTWARE REVISION NUMBER S-DAT (8205)	Use this function to view the software revision number of the software used to create the content of the S-DAT.

11.2.3 Function group AMPLIFIER

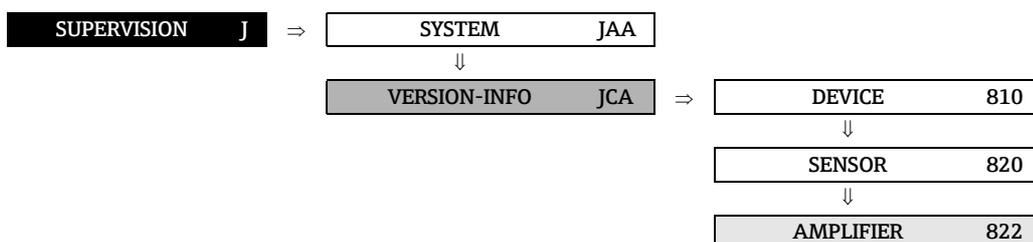

Function description	
SUPERVISION → VERSION-INFO → AMPLIFIER	
DEVICE SOFTWARE (8100)	Displays the current device software version.
SOFTWARE REVISION NUMBER AMPLIFIER (8222)	Use this function to view the software revision number of the amplifier.
SOFTWARE REVISION NUMBER T-DAT (8225)	Use this function to view the software revision number of the software used to create the content of the T-DAT.

Function description SUPERVISION → VERSION-INFO → AMPLIFIER	
LANGUAGE GROUP (8226)	<p>Use this function to view the language group.</p> <p>The following language groups can be ordered: WEST EU / USA, EAST EU / SCAND., ASIA , CHINA.</p> <p>Display: available language group</p> <p> Note!</p> <ul style="list-style-type: none">▪ The language options of the available language group are displayed in the LANGUAGE (2000) function.▪ You can change the language group via the configuration software FieldCare. Please do not hesitate to contact your E+H sales office if you have any questions.

11.2.4 Function group F-CHIP

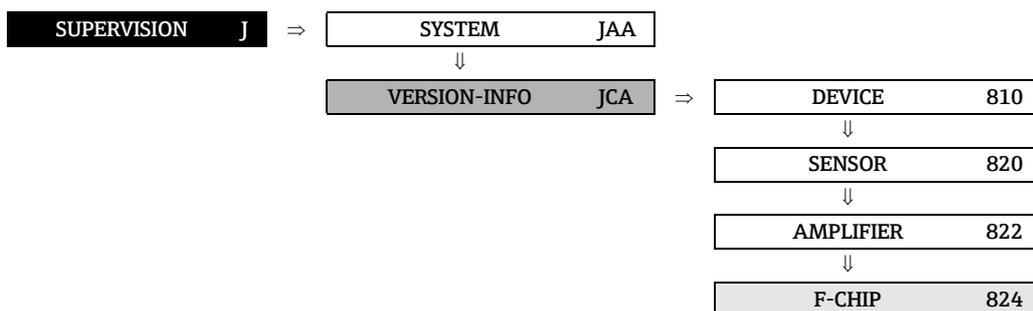

Function description	
SUPERVISION → VERSION-INFO → F-CHIP	
STATUS F-CHIP (8240)	Use this function to check whether an F-CHIP is installed and which software options are available.
SYSTEM OPTION (8241)	<p> Note! This function is not available unless the measuring device is equipped an F-CHIP.</p> <p>The software options available in the measuring device appear on the display.</p>
SOFTWARE REVISION NUMBER F-CHIP (8244)	<p> Note! The F-CHIP must be available in order to access this function.</p> <p>Use this function to view the software revision number of the F-CHIP.</p>

11.2.5 Function group I/O MODULE

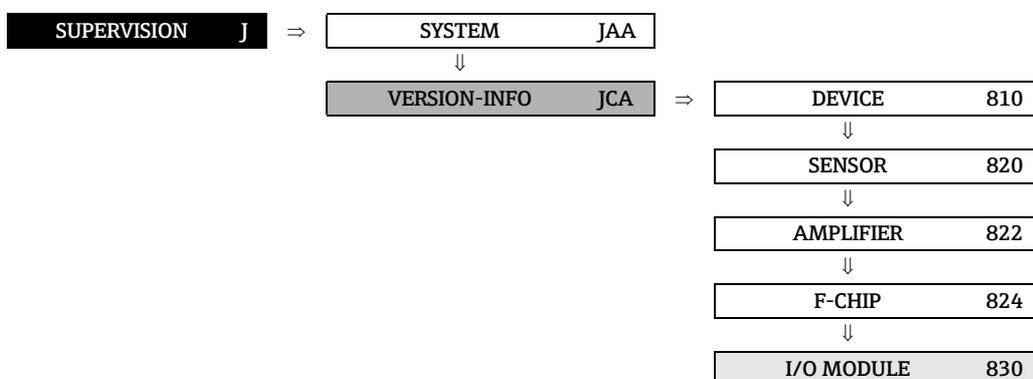

Function description	
SUPERVISION → VERSION-INFO → I/O MODULE	
I/O MODULE TYPE (8300)	Use this function to view the configuration of the I/O module complete with terminal numbers.
SOFTWARE REVISION NUMBER I/O MODULE (8303)	Use this function to view the software revision number of the I/O module.

11.2.6 Function groups INPUT/OUTPUT 1 to 4

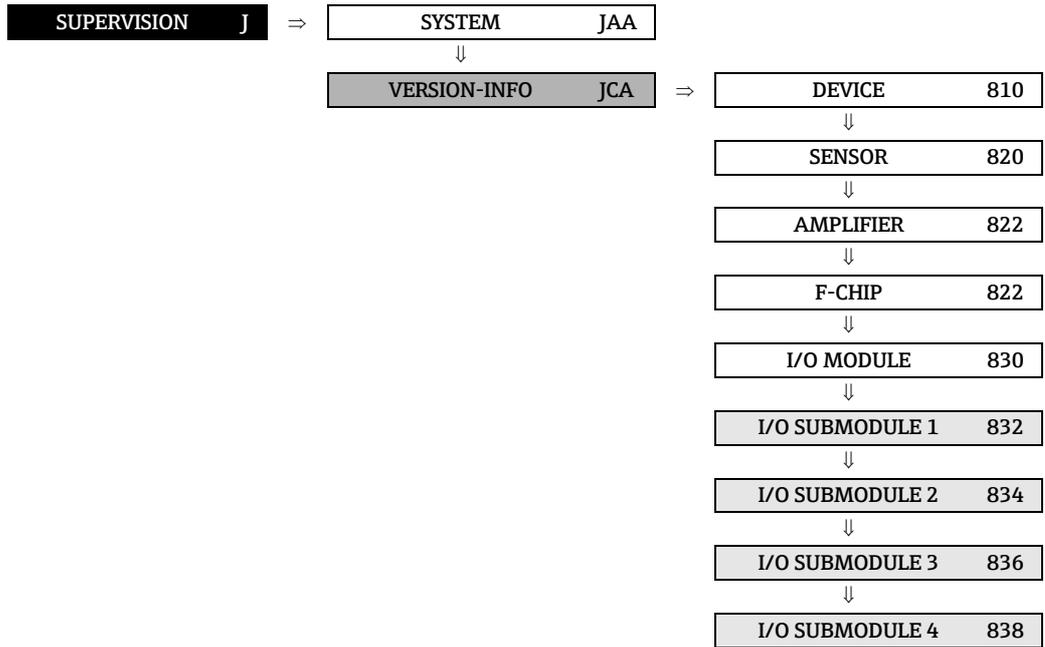

Function description	
SUPERVISION → VERSION-INFO → I/O SUBMODULE 1...4	
SUB-IN-/OUTPUT TYP: 1 = (8320), 2 = (8340), 3 = (8360), 4 = (8380)	Use this function to view the configuration complete with terminal numbers.
SOFTWARE REVISION NUMBER SUB-I/O TYPE 1 = (8323) 2 = (8343) 3 = (8363) 4 = (8383)	Use this function to view the software revision umber of the corresponding submodule.

12 Factory settings

12.1 SI units (not for USA and Canada)

12.1.1 Low flow cut off, full scale value, pulse value – Liquid

Nominal diam. [mm]	Low flow cut off (approx. v = 0.04 m/s)		Full scale value (approx. v = 2.0 m/s)		Pulse value (approx. 2 pulse/s at 2.0 m/s)	
1	0.08	kg/h	4	kg/h	0.001	kg/p
2	0.40	kg/h	20	kg/h	0.010	kg/p
4	1.80	kg/h	90	kg/h	0.010	kg/p
8	8.00	kg/h	400	kg/h	0.100	kg/p
15	26.00	kg/h	1300	kg/h	0.100	kg/p
15 FB	72.00	kg/h	3600	kg/h	1.000	kg/p
25	72.00	kg/h	3600	kg/h	1.000	kg/p
25 FB	180.00	kg/h	9000	kg/h	1.000	kg/p
40	180.00	kg/h	9000	kg/h	1.000	kg/p
40 FB	300.00	kg/h	15000	kg/h	10.000	kg/p
50	300.00	kg/h	15000	kg/h	10.000	kg/p
50 FB	720.00	kg/h	36000	kg/h	10.000	kg/h
80	720.00	kg/h	36000	kg/h	10.000	kg/p
100	1200.00	kg/h	60000	kg/h	10.000	kg/p
150	2600.00	kg/h	130000	kg/h	100.000	kg/p
250	7200.00	kg/h	360000	kg/h	100.000	kg/p

DN 15, 25, 40, 50 "FB" = Full bore versions of Promass I

12.1.2 Low flow cut off, full scale value, pulse value – Gas

Nom. diameter [mm]	Low flow cut off (approx. v = 0.01 m/s)		Full scale value (approx. v = 2 m/s)		Pulse value (approx. 2 pulse/s at 2 m/s)	
1	0.02	kg/h	4	kg/h	0.001	kg/p
2	0.10	kg/h	20	kg/h	0.010	kg/p
4	0.45	kg/h	90	kg/h	0.010	kg/p
8	2.00	kg/h	400	kg/h	0.100	kg/p
15	6.50	kg/h	1300	kg/h	0.100	kg/p
15 FB	18.00	kg/h	3600	kg/h	1.000	kg/p
25	18.00	kg/h	3600	kg/h	1.000	kg/p
25 FB	45.00	kg/h	9000	kg/h	1.000	kg/p
40	45.00	kg/h	9000	kg/h	1.000	kg/p
40 FB	75.00	kg/h	15000	kg/h	10.000	kg/p
50	75.00	kg/h	15000	kg/h	10.000	kg/p
50 FB	180.00	kg/h	36000	kg/h	10.000	kg/p
80	180.00	kg/h	36000	kg/h	10.000	kg/p
100	300.00	kg/h	60000	kg/h	10.000	kg/p
150	650.00	kg/h	130000	kg/h	100.000	kg/p
250	1800.00	kg/h	360000	kg/h	100.000	kg/p

DN 15, 25, 40, 50 "FB" = Full bore versions Promass I

12.1.3 Language

Country	Language
Australia	English
Belgium	English
China	Chinese
Denmark	English
Germany	Deutsch
England	English
Finland	Suomi
France	Francais
Netherlands	Nederlands
Hong Kong	English
India	English
Indonesia	Bahasa Indonesia
Instruments International	English
Italy	Italiano
Japan	Japanese
Malaysia	English
Norway	Norsk
Poland	Polish
Portugal	Portuguese
Austria	Deutsch
Russia	Russian
Sweden	Svenska
Switzerland	Deutsch
Singapore	English
Spain	Espanol
South Africa	English
Thailand	English
Czech Republic	Czech
Hungary	English

12.1.4 Density, length, temperature

	Unit
Density	kg/l
Length	mm
Temperature	°C

12.2 US units (only for USA and Canada)

12.2.1 Low flow cut off, full scale value, pulse value – Liquid

Nominal diam. [mm]	Low flow cut off (approx. v = 0.04 m/s)		Full scale value (approx. v = 2.0 m/s)		Pulse value (approx. 2 pulse/s at 2.0 m/s)	
1	0.003	lb/min	0.15	lb/min	0.002	lb/p
2	0.015	lb/min	0.75	lb/min	0.020	lb/p
4	0.066	lb/min	3.30	lb/min	0.020	lb/p
8	0.300	lb/min	15.00	lb/min	0.200	lb/p
15	1.000	lb/min	50.00	lb/min	0.200	lb/p
15 FB	2.600	lb/min	130.00	lb/min	2.000	lb/p
25	2.600	lb/min	130.00	lb/min	2.000	lb/p
25 FB	6.600	lb/min	330.00	lb/min	2.000	lb/p
40	6.600	lb/min	330.00	lb/min	2.000	lb/p
40 FB	11.000	lb/min	550.00	lb/min	20.000	lb/p
50	11.000	lb/min	550.00	lb/min	20.000	lb/p
50 FB	26.000	lb/min	1300.00	lb/min	20.000	lb/min
80	26.000	lb/min	1300.00	lb/min	20.000	lb/p
100	44.000	lb/min	2200.00	lb/min	20.000	lb/p
150	95.000	lb/min	4800.00	lb/min	200.000	lb/p
250	260.000	lb/min	13000.00	lb/min	200.000	lb/p

DN 15, 25, 40, 50 "FB" = Full bore versions of Promass I

12.2.2 Low flow cut off, full scale value, pulse value – Gas

Nominal diameter [mm]	Low flow cut off (approx. v = 0.01 m/s)		Full scale value (approx. v = 2 m/s)		Pulse value (approx. 2 pulse/s at 2 m/s)	
1	0.001	lb/min	0.15	lb/min	0.002	lb/p
2	0.004	lb/min	0.75	lb/min	0.020	lb/p
4	0.046	lb/min	3.30	lb/min	0.020	lb/p
8	0.075	lb/min	15.00	lb/min	0.200	lb/p
15	0.250	lb/min	50.00	lb/min	0.200	lb/p
15 FB	0.650	lb/min	130.00	lb/min	2.000	lb/p
25	0.650	lb/min	130.00	lb/min	2.000	lb/p
25 FB	1.650	lb/min	330.00	lb/min	2.000	lb/p
40	1.650	lb/min	330.00	lb/min	2.000	lb/p
40 FB	2.750	lb/min	550.00	lb/min	20.000	lb/p
50	2.750	lb/min	550.00	lb/min	20.000	lb/p
50 FB	6.500	lb/min	1300.00	lb/min	20.000	lb/p
80	6.500	lb/min	1300.00	lb/min	20.000	lb/p
100	11.000	lb/min	2200.00	lb/min	20.000	lb/p
150	23.750	lb/min	4800.00	lb/min	200.000	lb/p
250	65.000	lb/min	13000.00	lb/min	200.000	lb/p

DN 15, 25, 40, 50 "FB" = Full bore versions Promass I

12.2.3 Language, density, length, temperature

	Unit
Language	English
Density	g/cc
Length	INCH
Temperature	°F

Index function matrix

Blöcke

A = MEASURED VARIABLES 11
 B = QUICK SETUP 25
 C = USER INTERFACE 35
 D = TOTALIZER 57
 E = OUTPUT 62
 F = INPUT 113
 G = BASIC FUNCTION 121
 H = SPECIAL FUNCTION 140
 J = SUPERVISION 178

Gruppen

AAA = MEASURING VALUES 12
 ACA = SYSTEM UNITS 17
 AEA = SPECIAL UNITS 22
 CAA = CONTROL 36
 CCA = MAIN LINE 41
 CEA = ADDITIONAL LINE 45
 CGA = INFORMATION LINE 51
 DAA = TOTALIZER 1 58
 DAB = TOTALIZER 2 58
 DAC = TOTALIZER 3 58
 DJA = HANDLING TOTALIZER 61
 EAA = CURRENT OUTPUT 1 63
 EAB = CURRENT OUTPUT 2 63
 EAC = CURRENT OUTPUT 3 63
 ECA = PULSE/FREQUENCY OUTPUT 1 75
 ECB = PULSE/FREQUENCY OUTPUT 2 75
 EGA = RELAY OUTPUT 1 102
 EGB = RELAY OUTPUT 2 102
 FAA = STATUS INPUT 114
 FCA = CURRENT INPUT 117
 GAA = HART 122
 GIA = PROCESS PARAMETER 125
 GLA = SYSTEM PARAMETER 134
 GNA = SENSOR DATA 136
 HAA = DENSITY FUNCTIONS 142
 HCA = BATCHING FUNCTION 148
 HEA = ADVANCED DIAGNOSTICS 167
 JAA = SYSTEM 179
 JCA = VERSION INFO 183

Funktionsgruppen

000 = MAIN VALUES 12
 002 = ADDITIONAL VALUES 13
 040 = CONFIGURATION 17
 042 = ADDITIONAL CONFIGURATION 20
 060 = ARBITRARY UNIT 22
 200 = BASIC CONFIGURATION 36
 202 = UNLOCKING/LOCKING 39
 204 = OPERATION 40
 220 = CONFIGURATION 41
 222 = MULTIPLEX 43
 240 = CONFIGURATION 45
 242 = MULTIPLEX 48
 260 = CONFIGURATION 51

262 = MULTIPLEX 54
 300 = CONFIGURATION 58
 304 = OPERATION 60
 400 = CONFIGURATION 63
 404 = OPERATION 73
 408 = INFORMATION 74
 420 = CONFIGURATION 75
 430 = OPERATION 97
 438 = INFORMATION 101
 470 = CONFIGURATION 102
 474 = OPERATION 107
 478 = INFORMATION 109
 500 = CONFIGURATION 114
 504 = OPERATION 115
 508 = INFORMATION 116
 520 = CONFIGURATION 117
 524 = OPERATION 119
 528 = INFORMATION 120
 600 = CONFIGURATION 122
 604 = INFORMATION 124
 640 = CONFIGURATION 125
 642 = EPD PARAMETER 127
 646 = REFERENCE PARAMETER 129
 648 = ADJUSTMENT 131
 650 = PRESSURE CORRECTION 133
 660 = CONFIGURATION 134
 680 = CONFIGURATION 136
 684 = FLOW COEFFICIENT 137
 685 = DENSITY COEFFICIENT 138
 686 = ADDITIONAL COEFFICIENT 139
 700 = CONFIGURATION 142
 720 = CONFIGURATION 148
 722 = VALVE PARAMETER 154
 724 = SUPERVISION 159
 726 = OPERATION 163
 728 = INFORMATION 165
 740 = CONFIGURATION 167
 741 = ACQUISITION 168
 742 = MASS FLOW 169
 743 = DENSITY 170
 744 = REFERENCE DENSITY 171
 745 = TEMPERATURE 172
 746 = TUBE DAMPING 173
 747 = ELECTRODYNAMIC SENSORS 174
 748 = OPERATING FREQUENCY FLUCTUATION 175
 749 = TUBE DAMPING FLUCTUATION 176
 800 = CONFIGURATION 179
 804 = OPERATION 181
 810 = DEVICE 183
 820 = SENSOR 183
 822 = AMPLIFIER 183
 824 = F-CHIP 185
 830 = I/O MODULE 185
 832 = INPUT/OUTPUT 1 186
 834 = INPUT/OUTPUT 2 186
 836 = INPUT/OUTPUT 3 186

838 = INPUT/OUTPUT 4..... 186

Funktionen 0...

0000 = MASS FLOW 12
 0001 = VOLUME FLOW 12
 0004 = CORRECTED VOLUME FLOW 12
 0005 = DENSITY 12
 0006 = REFERENCE DENSITY 12
 0008 = TEMPERATURE 12
 0009 = PRESSURE 12
 0020 = TARGET MASS FLOW 13
 0021 = % TARGET MASS FLOW 13
 0022 = TARGET VOLUME FLOW 13
 0023 = % TARGET VOLUME FLOW 13
 0024 = CORRECTED TARGET VOLUME FLOW 14
 0025 = CARRIER MASS FLOW 14
 0026 = % CARRIER MASS FLOW 14
 0027 = CARRIER VOLUME FLOW 14
 0028 = % CARRIER VOLUME FLOW 14
 0029 = CORRECTED CARRIER VOL. FLOW 15
 0030 = % BLACK LIQUOR 15
 0031 = ° BAUME 15
 0033 = ° API 15
 0034 = ° PLATO 15
 0035 = ° BALLING 15
 0036 = ° BRIX 15
 0037 = OTHERS 16
 0400 = UNIT MASS FLOW 17
 0401 = UNIT MASS 17
 0402 = UNIT VOLUME FLOW 18
 0403 = UNIT VOLUME 18
 0404 = UNIT CORRECTED VOLUME FLOW 19
 0405 = UNIT CORRECTED VOLUME 19
 0420 = UNIT DENSITY 20
 0421 = UNIT REFERENCE DENSITY 20
 0422 = UNIT TEMPERATURE 21
 0424 = UNIT LENGTH 21
 0426 = UNIT PRESSURE 21
 0600 = TEXT ARBITRARY MASS 22
 0601 = FACTOR ARBITRARY MASS 22
 0602 = TEXT ARBITRARY VOLUME 22
 0603 = FACTOR ARBITRARY VOLUME 23
 0604 = TEXT ARBITRARY DENSITY 23
 0605 = FACTOR ARBITRARY DENSITY 23
 0606 = TEXT ARBITRARY CONCENTRATION 23
 0607 = FACTOR ARBITRARY CONCENTRATION 24

1...

1002 = QUICK SETUP COMMISSIONING 25
 1003 = QUICK SETUP PULSATING FLOW 25
 1004 = QUICK SETUP GAS MEASUREMENT 25
 1005 = QUICK SETUP BATCHING/DOSING 26
 1009 = T-DAT SAVE/LOAD 26

2...

2000 = LANGUAGE 36,37
 2002 = DISPLAY DAMPING 37
 2003 = CONTRAST LCD 37
 2004 = BACKLIGHT 38

2020 = ACCESS CODE 39
 2021 = DEFINE PRIVATE CODE 39
 2022 = STATUS ACCESS 39
 2023 = ACCESS CODE 39
 2040 = TEST DISPLAY 40
 2200 = ASSIGN 41
 2201 = 100% VALUE 42
 2202 = FORMAT 42
 2220 = ASSIGN 43
 2221 = 100% VALUE 44
 2222 = FORMAT 44
 2400 = ASSIGN 45
 2401 = 100% VALUE 46
 2402 = FORMAT 47
 2403 = DISPLAY MODE 47
 2420 = ASSIGN 48
 2421 = 100% VALUE 49
 2422 = FORMAT 50
 2423 = DISPLAY MODE 50
 2600 = ASSIGN 51
 2601 = 100% VALUE 52
 2602 = FORMAT 53
 2603 = DISPLAY MODE 53
 2620 = ASSIGN 54
 2621 = 100% VALUE 55
 2622 = FORMAT 56
 2623 = DISPLAY MODE 56

3...

3000 = ASSIGN 58
 3001 = UNIT TOTALIZER 59
 3002 = TOTALIZER MODE 59
 3003 = RESET TOTALIZER 59
 3040 = SUM 60
 3041 = OVERFLOW 60
 3800 = RESET ALL TOTALIZERS 61
 3801 = FAILSAFE MODE 61

4...

4000 = ASSIGN CURRENT OUTPUT 63
 4001 = CURRENT SPAN 65
 4002 = VALUE 0_4 mA 66
 4003 = VALUE 20 mA 68
 4004 = MEASURING MODE 69
 4005 = TIME CONSTANT 71
 4006 = FAILSAFE MODE 72
 4040 = ACTUAL CURRENT 73
 4041 = SIMULATION CURRENT 73
 4042 = VALUE SIMULATION CURRENT 73
 4080 = TERMINAL NUMBER 74
 4200 = OPERATION MODE 75
 4201 = ASSIGN FREQUENCY 76
 4202 = START VALUE FREQUENCY 77
 4203 = END VALUE FREQUENCY 77
 4204 = VALUE F LOW 78
 4205 = VALUE F HIGH 78
 4206 = MEASURING MODE 80
 4207 = OUTPUT SIGNAL 82,83,84
 4208 = TIME CONSTANT 85

4209 = FAILSAFE MODE 85
 4211 = FAILSAFE VALUE..... 85
 4221 = ASSIGN PULSE 86
 4222 = PULSE VALUE 86
 4223 = PULSE WIDTH..... 87
 4225 = MEASURING MODE 88
 4226 = OUTPUT SIGNAL..... 89,90,91
 4227 = FAILSAFE MODE 92
 4241 = ASSIGN STATUS 93,94
 4242 = ON VALUE..... 94
 4243 = SWITCH-ON DELAY 94
 4244 = OFF VALUE 95
 4245 = SWITCH-OFF DELAY 95
 4246 = MEASURING MODE 96
 4247 = TIME CONSTANT 96
 4301 = ACTUAL FREQUENCY 97
 4302 = SIMULATION FREQUENCY 97
 4303 = VALUE SIMULATION FREQUENCY 98
 4322 = SIMULATION PULSE 98
 4323 = VALUE SIMULATION PULSE..... 99
 4341 = ACTUAL STATUS 99
 4342 = SIMULATION SWITCH POINT..... 99
 4343 = VALUE SIMULATION SWITCH POINT 100
 4380 = TERMINAL NUMBER 101
 4700 = ASSIGN RELAY 102
 4701 = ON VALUE..... 104
 4702 = SWITCH-ON DELAY 104
 4703 = OFF VALUE 104
 4704 = SWITCH-OFF DELAY 105
 4705 = MEASURING MODE 105
 4706 = TIME CONSTANT 106
 4740 = ACTUAL STATUS RELAY..... 107
 4741 = SIMULATION SWITCH POINT..... 107
 4742 = VALUE SIMULATION SWITCH POINT 108
 4780 = TERMINAL NUMBER 109

5...

5000 = ASSIGN STATUS INPUT 114
 5001 = ACTIVE LEVEL 114
 5002 = MINIMUM PULSE WIDTH..... 114
 5040 = ACTUAL STATUS INPUT 115
 5041 = SIMULATION STATUS INPUT 115
 5042 = VALUE SIMULATION STATUS INPUT 115
 5080 = TERMINAL NUMBER 116
 5200 = ASSIGN CURRENT INPUT 117
 5201 = CURRENT SAPN 117
 5202 = VALUE 0_4 mA 117
 5203 = VALUE 20 mA 118
 5204 = FAILSAFE MODE 118
 5240 = ACTUAL CURRENT INPUT..... 119
 5241 = SIMULATION CURRENT..... 119
 5242 = VALUE SIMULATION CURRENT..... 119
 5245 = TERMINAL NUMBER 120

6...

6000 = TAG NAME 122
 6001 = TAG DESCRIPTION 122
 6002 = BUS ADDRESS 122
 6003 = HART PROTOCOL 122

6004 = WRITE PROTECTION..... 123
 6006 = LONG TAG 1...14 122
 6006 = LONG TAG 15...28 122
 6006 = LONG TAG 29...32 122
 6007 = SELECTION ERROR MESSAGE 123
 6008 = ASSIGN NE107 COND. STAT 123
 6009 = SIMULATION HART STATUS 123
 6040 = MANUFACTURER ID 124
 6041 = DEVICE ID 124
 6042 = DEVICE REVISION 124
 6043 = HART MESSAGES RECV 124
 6043 = HART MESSAGES SENT 124
 6400 = ASSIGN LOW FLOW CUT OFF 125
 6402 = ON-VALUE LOW FLOW CUT OFF 125
 6403 = OFF-VALUE LOW FLOW CUT OFF 125
 6404 = PRESSURE SHOCK SUPPRESSION 126
 6420 = EMPTY PIPE DETECTION 127
 6423 = EPD VALUE LOW..... 127
 6424 = EPD VALUE HIGH 127
 6425 = EPD RESPONSE TIME 127
 6460 = CORRECTED VOLUME CALCULATION 129
 6461 = FIXED REFERENCE DENSITY 129
 6462 = EXPANSION COEFFICIENT 129
 6463 = SQUARE EXPANSION COEFFICIENT 129
 6464 = REFERENCE TEMPERATURE 130
 6480 = ZEROPOINT ADJUST 131
 6482 = DENSITY ADJUST MODE..... 131
 6483 = DENSITY SETPOINT 1 131
 6484 = MEASURE FLUID 1 131
 6485 = DENSITY SETPOINT 2 132
 6486 = MEASURE FLUID 2 132
 6487 = DENSITY ADJUST..... 132
 6488 = RESTORE ORIGINAL 132
 6500 = PRESSURE MODE..... 133
 6501 = PRESSURE..... 133
 6600 = INSTALLATION DIRECTION SENSOR..... 134
 6602 = DENSITY DAMPING 134
 6603 = FLOW DAMPING..... 134
 6605 = POSITIVE ZERO RETURN..... 134
 6606 = TEMPERATURE MEASUREMENT 135
 6800 = K-FACTOR..... 136
 6803 = ZEROPOINT..... 136
 6804 = NOMINAL DIAMETER..... 136
 6840 = TEMPERATURE COEFFICIENT KM 137
 6841 = TEMPERATURE COEFFICIENT KM 2..... 137
 6842 = TEMPERATURE COEFFICIENT KT 137
 6843 = CALIBRATION COEFFICIENT KD 1..... 137
 6844 = CALIBRATION COEFFICIENT KD 2..... 137
 6850 = DENSITY COEFFICIENT C 0..... 138
 6851 = DENSITY COEFFICIENT C 1..... 138
 6852 = DENSITY COEFFICIENT C 2..... 138
 6853 = DENSITY COEFFICIENT C 3..... 138
 6854 = DENSITY COEFFICIENT C 4..... 138
 6855 = DENSITY COEFFICIENT C 5..... 138
 6860 = MINIMAL TEMP. MEASURED 139
 6861 = MAXIMAL TEMP. MEASURED 139
 6862 = MINIMAL TEMP. CARRIER TUBE 139
 6863 = MAXIMAL TEMP. CARRIER TUBE..... 139

7...

7000 = DENSITY FUNCTION.	142
7001 = REFERENCE DENSITY CARRIER FLUID	142
7002 = EXP. COEF. LIN. CARR. FL.	142
7003 = EXP. COEF. SQR. CARR. FL.	143
7004 = REFERENCE DENSITY TARGET FLUID	143
7005 = EXP. COEF. LIN. TARG. FL.	143
7006 = EXP. COEF. SQR. TARG. FL.	144
7007 = LINEAR EXPANSION COEFFICIENT	144
7008 = SQUARE EXPANSION COEFFICIENT	144
7009 = REFERENCE TEMPERATURE	144
7021 = MODE.	145
7022 = CONCENTRATION SELECTOR.	146
7031 = CONCENTRATION NAME	146
7032 = COEFFICIENT A0	146
7033 = COEFFICIENT A1	146
7034 = COEFFICIENT A2	146
7035 = COEFFICIENT A3	146
7036 = COEFFICIENT A4	147
7037 = COEFFICIENT B1.	147
7038 = COEFFICIENT B2.	147
7039 = COEFFICIENT B3.	147
7200 = BATCH SELECTOR	148
7201 = BATCH NAME.	148
7202 = ASSIGN BATCH VARIABLE	149
7203 = BATCH QUANTITY	149
7204 = FIXED COMPENSATION QUANTITY.	149
7205 = COMPENSATION MODE	150
7206 = CALCULATION MODE	152
7207 = AVERAGING DRIP.	152
7208 = BATCH STAGES	153
7209 = INPUT FORMAT	153
7220 = OPEN VALVE 1.	154
7221 = CLOSE VALVE 1	154
7222 = OPEN VALVE 2.	155
7223 = CLOSE VALVE 2	155
7240 = MAXIMUM BATCHING TIME	159
7241 = MINIMUM BATCHING QUANTITY.	160
7242 = MAXIMUM BATCHING QUANTITY	161
7243 = PROGRESS NOTE	161
7244 = MAX. FLOW	162
7260 = BATCH PROCEDURE	163
7261= BATCH UPWARDS	163
7262= BATCH DOWNWARDS	163
7263 = BATCH COUNTER.	164
7264 = BATCH SUM	164
7265 = RESET SUM/COUNTER	164
7280 = VALVE 1 INTERNAL SWITCH POINT.	165
7281 = DRIP QUANTITY	165
7282 = VALVE 1 CLOSING TIME.	165
7283 = BATCHING TIME	166
7401 = REFERENCE CONDITION USER.	167
7402 = SELECT REFERENCE CONDITION.	167
7403 = WARNING MODE.	167
7410 = ACQUISITION MODE	168
7411 = ACQUISITION PERIOD	168
7412 = ACQUISITION DO	168
7413 = RESET HISTORY	168
7420 = REFERENCE VALUE MASS FLOW	169

7421 = MASS FLOW	169
7422 = MINIMUM VALUE (MASS FLOW)	169
7423 = MAXIMUM VALUE (MASS FLOW)	169
7424 = MASS FLOW HISTORY	169
7425 = MASS FLOW DEVIATION.	169
7426 = WARNING LEVEL (MASS FLOW)	169
7430 = REFERENCE VALUE DENSITY	170
7431 = DENSITY	170
7432 = MINIMUM VALUE (DENSITY)	170
7433 = MAXIMUM VALUE (DENSITY)	170
7434 = DENSITY HISTORY.	170
7435 = DENSITY DEVIATION	170
7436 = WARNING LEVEL (DENSITY).	170
7440 = REFERENCE VALUE REFERENCE DENSITY ..	171
7441 = REFERENCE DENSITY	171
7442 = MINIMUM VALUE (REFERENCE DENSITY) ..	171
7443 = MAXIMUM VALUE (REFERENCE DENSITY) .	171
7444 = REFERENCE DENSITY HISTORY.	171
7445 = REFERENCE DENSITY DEVIATION	171
7446 = WARNING LEVEL (REFERENCE DENSITY)...	171
7450 = REFERENCE VALUE TEMPERATURE	172
7451 = TEMPERATURE	172
7452 = MINIMUM VALUE (TEMPERATURE)	172
7453 = MAXIMUM VALUE (TEMPERATURE)	172
7454 = TEMPERATURE HISTORY.	172
7455 = TEMPERATURE DEVIATION	172
7456 = WARNING LEVEL (TEMPERATURE).	172
7460 = REFERENCE VALUE TUBE DAMPING.	173
7461 = TUBE DAMPING	173
7462 = MINIMUM VALUE (TUBE DAMPING)	173
7463 = MAXIMUM VALUE (TUBE DAMPING)	173
7464 = TUBE DAMPING HISTORY	173
7465 = TUBE DAMPING DEVIATION.	173
7466 = WARNING LEVEL (TUBE DAMPING)	173
7470 = REF. VALUE EL.-DYN. SENSORS	174
7471 = ELECTRODYNAMIC SENSORS	174
7472 = MINIMUM VALUE (EL-DYN. SENSORS)	174
7473 = MAXIMUM VALUE (EL-DYN. SENSORS) ...	174
7474 = EL-DYN. SENSORS HISTORY.	174
7475 = EL-DYN. SENSORS DEVIATION	174
7476 = WARNING LEVEL (EL-DYN. SENSORS).	174
7480 = REF. VALUE OP. FREQ. FLUCT.	175
7481 = OPERATING FREQUENCY FLUCT.	175
7482 = MINIMUM VALUE (OP. FREQ. FLUCT.)	175
7483 = MAXIMUM VALUE (OP. FREQ. FLUCT.)	175
7484 = HISTORY OPERATING FREQUENCY FLUCT... 175	
7485 = DEVIATION OPERATING FREQUENCY FLUCT. 175	
7486 = WARNING LEVEL	175
7490 = REF. VALUE TUBE DAMPING FLUCT.	176
7491 = TUBE DAMPING FLUCTUATION	176
7492 = MINIMUM VALUE (TUBE DAMPING FLUCT.) 176	
7493 = MAXIMUM VALUE (TUBE DAMPING FLUCT.) ... 176	
7494 = HISTORY TUBE DAMPING FLUCT.	176
7495 = DEVIATION TUBE DAMPING FLUCT.	176
7496 = WARNING LEVEL	177

8...

8000 = ASSIGN SYSTEM ERROR.	179
----------------------------------	-----

8001 = ERROR CATEGORY	179	8205 = SW REV. NO. S-DAT	183
8002 = ASSIGN PROCESS ERROR.....	179	8222 = SW REV. NO. AMPLIFIER.....	183
8003 = ERROR CATEGORY	179	8225 = SOFTWARE REV. NO. T-DAT	183
8004 = ACKNOWLEDGE FAULTS	180	8226 = LANGUAGE GROUP.....	184
8005 = ALARM DELAY	180	8240 = STATUS F-CHIP	185
8006 = REMOVE SW-OPTION	180	8241 = SYSTEM OPTION	185
8007 = PERMANENT STORAGE	180	8244 = SW REV. NO. F-CHIP.....	185
8040 = ACTUAL SYSTEM CONDITION	181	8300 = I/O MODULE TYPE.....	185
8041 = PREVIOUS SYSTEM CONDITION.....	181	8303 = SW-REV. NO. I/O MODULE	185
8042 = SIMULATION FAILSAFE MODE	181	8320 = SUB-I/O TYPE.....	186
8043 = SIMULATION MEASURAND	181	8323 = SW REV. SUB-I/O.....	186
8044 = VALUE SIMULATION MEASURAND	181	8340 = SUB-I/O TYPE.....	186
8046 = SYSTEM RESET	182	8343 = SW REV. SUB-I/O.....	186
8048 = OPERATION HOURS.....	182	8360 = SUB-I/O TYPE.....	186
8100 = DEVICE SOFTWARE	183	8363 = SW REV. SUB-I/O.....	186
8200 = SERIAL NUMBER	183	8380 = SUB-I/O TYPE.....	186
8201 = SENSOR TYPE	183	8383 = SW REV. SUB-I/O.....	186

Index key words

A

Access code	39
Acknowledge faults	180
Acquisition	
Do	168
Mode	168
Period	168
Acquisition (Advanced diagnosis)	168
Active level	114
Actual	
Current (current input)	119
Current (current output)	73
Frequency	97
Actual Status	
Relay output	107
Status input	115
Switch point (pulse/frequency output)	99
Actual System condition	181
Additional configuration	20
Additional line	
Configuration	45
Multiplex	48
Additional values	13
Adjustment	
Density	132
Zero point	131
Advanced diagnostics	
Acquisition	168
Configuration	167
Density	170
Electrodynamic sensors	174
Mass flow	169
Operating frequency fluctuation	175
Reference density	171
Temperature	172
Tube damping	173
Tube damping fluctuation	176
Alarm delay	180
Amplifier (Version Info)	183
Arbitrary unit	22
Assign	
Additional line	45
Additional line (Multiplex)	48
Current input	117
Current output	63
Frequency (Pulse/Freq. output)	76
Information line	51
Information line (Multiplex)	54
Low flow cut off	125
Main line	41
Main line (Multiplex)	43
Process error	179
Pulse	86
Relay (relay output)	102
Status input	114
Status (Pulse/Freq. output)	93, 94

System error	179
Totalizer	58
Assign Batch variable	149
Averaging drip	152

B

Backlight (user interface)	38
Basic Configuration (user interface)	36
Basic functions	121
Batch Counter	164
Batch Name	148
Batch Procedure	163
Batch quantity	149
Downwards	163
Upwards	163
Batch Selector	148
Batch Stages	153
Batch Sum	164
Batching function	
Configuration	148
Batching time	166
Batching/Dosing	26
Block	
Basic functions	121
Display	35
Inputs	113
Measured variables	11
Outputs	62
Quick Setup	25
Special function	140
Supervision	178
Totalizer	57
Bus address	122

C

Calculation mode	152
Calibrate	
Coefficient	
KD 1	137
KD 2	137
Carrier Mass flow	14
Carrier Volume flow	14
Close	
Valve 1	154
Valve 2	155
Coefficient	
Calibration	
KD 1	137
KD 2	137
Concentration	
A0	146
A1	146
A2	146
A3	146
A4	147
B1	147

B2	147	Density	12
B3	147	Adjustment	132
Density		Coefficient	
C 0	138	C 0	138
C 1	138	C 1	138
C 2	138	C 2	138
C 3	138	C 3	138
C 4	138	C 4	138
C 5	138	C 5	138
Expansion	129	Damping	134
Expansion Square	129	Function	142
Temperature		Density Adjust mode	131
KM	137	Density functions	
KM 2	137	Configuration	142
KT	137	Density (Advanced diagnosis)	
Commissioning	25	Density	170
Compensation Mode	150	Deviation	170
Compensation Quantity (fixed)	149	History	170
Concentration selection (density function)	146	Maximum	170
Configuration		Minimum	170
Additional line	45	Warning level	170
Advanced diagnostics	167	Device ID	124
Batching function	148	Device revision	124
Current input	117	Device (version-info)	183
Current output	63	Display	35
Density functions	142	Display damping	37
HART	122	Display light	38
Information line	51	Display mode	
Main line	41	Additional line	47
Process parameter	125	Additional line (Multiplex)	50
Pulse/Frequency output	75	Information line	53
Relay output	102	Information line (Multiplex)	56
Sensor data	136	Display test	40
Status input	114	Drip quantity	165
System	179	E	
System parameter	134	Electrodynamic sensors (Advanced diagnosis)	
System units	17	Deviation	174
Totalizer	58	Electrodynamic sensors	174
Contrast LCD	37	History	174
Corrected Carrier volume flow	15	Maximum	174
Corrected Target volume flow	14	Minimum	174, 175
Corrected Volume calculation	129	Warning level	174
Corrected volume flow	12	Empty pipe detection (EPD)	127
Current input		End value frequency	77
Configuration	117	EPD	
Information	120	Empty pipe detection	127
Operation	119	Parameter	127
Current output		Response time	127, 128
Configuration	63	Value high	127
Information	74	Value low	127
Operation	73	Error category	
Current range		Process error	179
Current output	65	System error	179
D		Error message	123
Damping		Expansion coefficient	129
Density	134	Linear	144
System	134	Carrier fluid	142
Define private code	39	Target fluid	143

Square144
 Carrier fluid143
 Target fluid144
 Expansion coefficient Square129

F

Factor

- Arbitrary concentration24
- Arbitrary density23
- Arbitrary mass22
- Arbitrary volume23

Factory settings

- Full scale value187
- Low flow cut off187
- Pulse value187

Failsafe mode

- All totalizers61
- Current input118
- Current output72
- Frequency output85
- Pulse output92

Failsafe value85

F-CHIP (Version Info)185

Fixed Compensation quantity149

Fixed Reference density129

Flow162

Format

- Additional line47
- Additional line (Multiplex)50
- Information line53
- Information line (Multiplex)56
- Main line42
- Main line (Multiplex)44

Function group

Acquisition

- Advanced diagnostics168

Additional coefficient139

Additional configuration20

Additional values13

Adjustment131

Amplifier183

Arbitrary unit22

Basic Configuration (user interface)36

Configuration

- Additional line45
- Advanced diagnostics167
- Batching function148
- Current input117
- Current output63
- Density functions142
- HART122
- Information line51
- Main line41
- Process parameter125
- Pulse/Freq. output75
- Relay output102
- Sensor data136
- Status input114
- System179

- System parameter134
- System units17
- Totalizer58

Density

- Advanced diagnostics170

Density coefficient138

Device183

Electrodynamic sensors

- Advanced diagnostics174

EPD parameter127

F-CHIP185

Flow coefficient137

Information

- Batching function165
- Current input120
- Current output74
- HART124
- Pulse/Frequency output101
- Relay output109
- Status input116

Input/Output186

I/O Module185

Main values12

Mass flow

- Advanced diagnostics169

Multiplex

- Additional line48
- Information line54
- Main line43

Operating frequency fluctuation

- Advanced diagnostics175

Operation

- Batching function163
- Current input119
- Current output73
- Pulse/Frequency output97
- Relay output107
- Status input115
- System181
- Totalizer60

Operation (display)40

Pressure correction133

Reference density

- Advanced diagnostics171

Reference parameter129

Sensor183

Supervision

- Batching function159

Temperature

- Advanced diagnostics172

Tube damping

- Advanced diagnostics173

Tube damping fluctuation

- Advanced diagnostics176

Unlocking/Locking (user interface)39

Valve parameter

- Batching function154

Function matrix

- Codes identifying9

General layout	8	Selection	36, 37
Overview	10	LCD contrast	37
G		Low flow cut off	
Gas measurement	25	Assign	125
Group		Off value	125
Additional line	45	On value	125
Advanced diagnostics	167	M	
Batching function	148	Main line	
Control (display)	36	Configuration	41
Current input	117	Multiplex	43
Current output	63	Main values	12
Handling Totalizer	61	Manufacturer ID	124
HART	122	Mass flow	12
Information line	51	Mass flow (Advanced diagnosis)	
Main line	41	Deviation	169
Measuring values	12	History	169
Process parameter	125	Mass flow	169
Pulse/Frequency output	75	Maximum	169
Relay output	102	Minimum	169
Sensor data	136	Reference value	169
Special units	22	Warning level	169
Status input	114	Maximal	
System	179	Temperature carrier tube	139
System parameter	134	Temperature measured	139
System units	17	Maximum	162
Version Info	183	Maximum Batching quantity	161
H		Maximum Batching time	159
Handling Totalizer	61	Measure Fluid 1	131
HART		Measure Fluid 2	132
Configuration	122	Measured variables	11
Information	124	Measuring mode	
HART messages	124	Current output	69
HART Protocol	122	Frequency (Pulse/Freq. output)	80
I		Pulse output	88
Information		Relay output	105
Batching function	165	Status (Pulse/Freq. output)	96
Current input	120	Measuring values	12
Current output	74	Additional values	13
Pulse/Frequency output	101	Main values	12
Relay output	109	Minimal	
Status input	116	Temperature carrier tube	139
Information line		Temperature measured	139
Configuration	51	Minimum Batching quantity	160
Multiplex	54	Minimum Pulse width	114
Input format	153	Mode (density function)	145
Inputs	113	Multiplex	
Input/Output 1...4	186	Additional line	48
Installation direction sensor	134	Information line	54
I/O Module	185	Main line	43
K		N	
K-Factor	136	NE107 category	123
L		Nominal diameter	136
Language		O	
Factory setting (country)	188	Off value	
Language group (display)	184	Low flow cut off	125
		Relay output	104
		Status (Pulse/Freq. output)	95

On value	
Low flow cut off	125
Relay output	104
Status (Pulse/Freq. output)	94
Open	
Valve 1	154
Valve 2	155
Operating frequency fluct. (Advanced diagnosis)	
Deviation	175
History	175
Maximum	175
Minimum	175
Operating frequency fluct.	175
Warning level	175
Operation	
Basic configuration	36
Batching function	163
Current input	119
Current output	73
Display	40
Operation	40
Pulse/Frequency output	75, 97
Relay output	107
Status input	115
System	181
Totalizer	60
Unlocking/Locking	39
Operation hours	182
Other (unit of concentration)	16
Output signal	
Frequency output	82
Pulse output	89, 90, 91
Outputs	62
Overflow	
Totalizer	60
P	
Positive zero return	134
Pressure	12, 133
Pressure correction	133
Pressure Mode	133
Pressure Shock suppression	126
Previous system condition	181
Process parameter	
Adjustment	131
Configuration	125
EPD parameter	127
Pressure correction	133
Reference parameter	129
Progress note	161
Pulsating flow	25
Pulse value	86
Pulse Width	87
Pulse/Frequency output	
Configuration	75
Information	101
Operation	97
Q	
Quick Setup	25
Batching/Dosing	26
Commissioning	25
Gas measurement	25
Pulsating flow	25
R	
Refer to installation direction for flow direction	134
Reference condition	
Selection	167
User	167
Reference density	12
Carrier fluid	142
Target fluid	143
Reference density (Advanced diagnosis)	
Deviation	171
History	171
Maximum	171
Minimum	171
Reference density	171
Warning level	171
Reference density (fixed)	129
Reference Temperature	130, 144
Relay output	
Configuration	102
Flow direction	110
General	110
Information	109
Limit value	110
Operation	107
Switching behavior	111
Remove SW-OPTION	180
Reset	
All totalizers	61
History	168
System	182
Totalizer	59
Reset Sum/Counter	164
Restore original	132
S	
Sensor data	
Additional coefficient	139
Configuration	136
Density coefficient	138
Flow coefficient	137
Sensor type	183
Sensor (Version info)	183
Serial number sensor	183
Setpoint	
Density 1	131
Density 2	132
Simulation	
Current (current output)	73
Failsafe mode	181
Frequency	97
HART status	123
Measured variable	181

Status input	115	Temperature (Advanced diagnosis)	
Switch point (Relay output)	107	Deviation	172
Simulation Pulse	98	History	172
Software		Maximum	172
Amplifier	183	Minimum	172
Software revision number		Temperature	172
Amplifier	183	Warning level	172
F-CHIP	185	Terminal number	
I/O Module	185	Current input	120
S-DAT	183	Current output	74
T-DAT	183	Pulse/Frequency output	101
Special units		Relay output	109
Arbitrary unit	22	Status input	116
Start value frequency	77	Test display	40
Status access	39	Text	
Status F-CHIP	185	Arbitrary concentration	23
Status input		Arbitrary density	23
Configuration	114	Arbitrary mass	22
Information	116	Arbitrary volume	22
Operation	115	Time constant	
Store permanently	180	Current output	71
Sum		Frequency output	85
Totalizer	60	Relay output	106
Supervision	178	Status (Pulse/Freq. output)	96
Batching function	159	Totalizer	57
Switching behavior of the relay output	111	Configuration	58
Switch-off delay		Operation	60
Relay output	105	Totalizer Mode	59
Status (Pulse/Freq. output)	95	Totalizer Reset	59
Switch-on delay		Tube damping fluct. (Advanced diagnosis)	
Relay output	104	Deviation	176
Status (Pulse/Freq. output)	94	History	176
System		Maximum	176
Configuration	179	Minimum	176
Damping	134	Tube damping fluct.	176
Operation	181	Warning level.	177
Operation hours	182	Tube damping (Advanced diagnosis)	
Reset	182	Deviation	173
System condition		History	173
Actual	181	Maximum	173
Previous	181	Minimum	173
System parameter		Tube damping	173
Configuration	134	Warning level	173
System units		Type	
Additional configuration	20	Input/Output 1...4	186
Configuration	17	I/O Module	185
T		Sub-input/Sub-output 1...4	186
Tag Description	122	U	
Tag Name	122	Unit	
Tag name	122	Corrected volume	19
Target Mass flow	13	Corrected volume flow	19
Target Volume flow	13	Density	20
T-DAT Save/Load	26	Length	21
Temperature	12	Mass	17
Coefficient		Mass flow	17
KM	137	Pressure	21
KM 2	137	Reference density	20
KT	137	Temperature	21

Totalizer	59
Volume	18
Volume flow	18
Unlocking/Locking (user interface)	39

V

Value F High	78
Value F Low	78
Value simulation	
Current (current input)	119
Current (current output)	73
Frequency	98
Measured variable	181
Status input	115
Switch point (pulse/freq. output)	100
Switch point (Relay output)	108
Value Simulation Pulse	99
Value 0_4 mA	
Current input	117
Current output	66
Value 20 mA	
Current input	118
Current output	68
Valve parameter	
Batching function	154
Valve 1 Closing time	165
Valve 1 Internal switch point	165
Version Info	
Amplifier	183
F-CHIP	185
Input/Output 1...4	186
I/O Module	185
Sensor	183
Volume flow	12

W

Warning mode	167
Write protection	123

Z

Zero point	136
Zero Point adjust	131

Symbole

% Black liquor	15
% Carrier Mass flow	14
% Carrier Volume flow	14
% Target Mass flow	13
% Target Volume flow	13
°Api	15
°Balling	15
°Baume	15
°Brix	15
°Plato	15

Zahlen

100% Value	
Additional line	46
Additional line (Multiplex)	49
Information line	52

Information line (Multiplex)	55
Main line	42
Main line (Multiplex)	44

www.endress.com/worldwide

Endress+Hauser 
People for Process Automation
