



Level



Pressure



Flow



Temperature



Liquid
Analysis



Registration



Systems
Components



Services



Solutions

Operating Instructions

Proline Promass 83 FOUNDATION Fieldbus

Coriolis mass flow measuring system

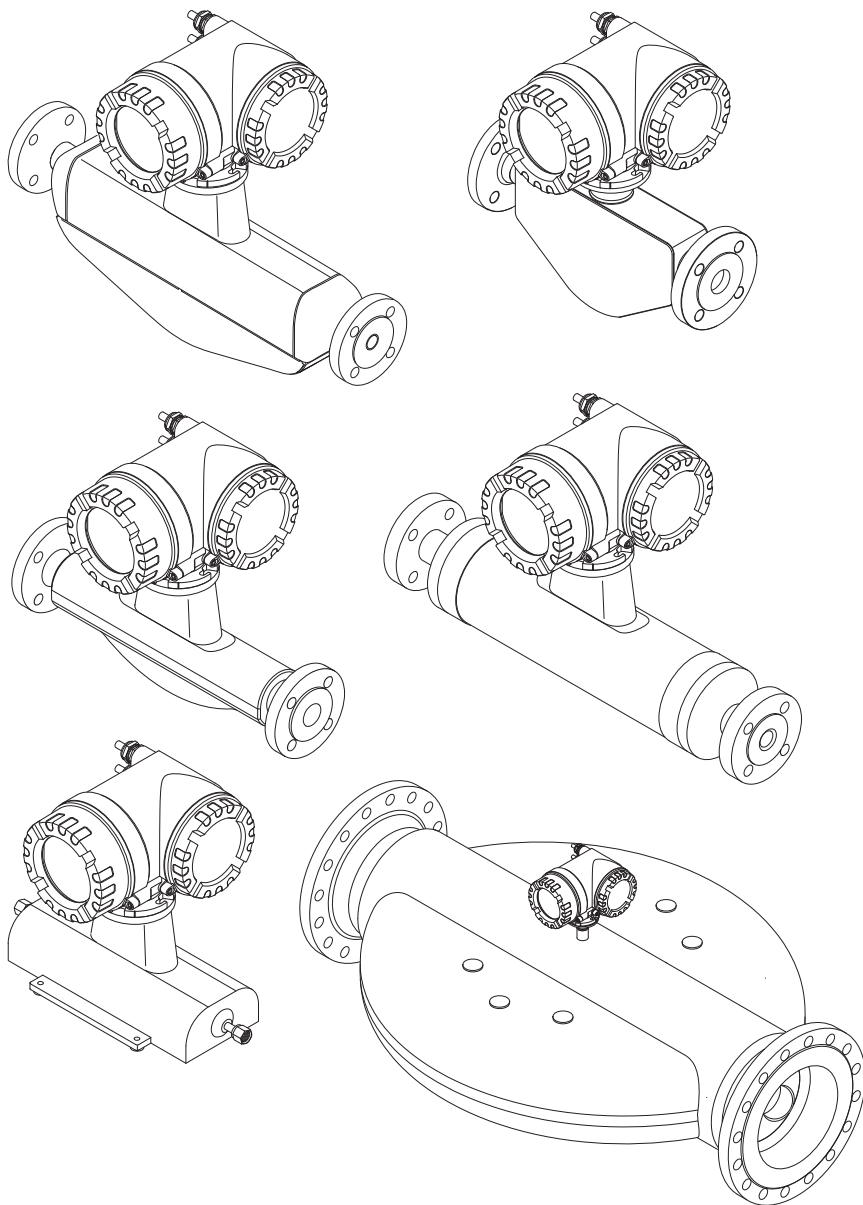

BA00065D/06/EN/14.12
71197486

Valid as of version
V 3.00.XX (device software)

Table of contents

1	Safety instructions	5	4.4	Degree of protection	33
1.1	Designated use	5	4.5	Post-connection check	34
1.2	Installation, commissioning and operation	5	5	Operation	35
1.3	Operational safety	6	5.1	Quick operation guide	35
1.4	Return	6	5.2	Local display	36
1.5	Notes on safety conventions and icons	6	5.2.1	Display and operating elements	36
2	Identification	7	5.2.2	Display (operating mode)	37
2.1	Device designation	7	5.2.3	Icons	38
2.1.1	Nameplate of the transmitter	8	5.3	Brief operating instructions on the function matrix	40
2.1.2	Nameplate of the sensor	9	5.3.1	General notes	41
2.1.3	Nameplate for connections	10	5.3.2	Enabling the programming mode	41
2.2	Certificates and approvals	11	5.3.3	Disabling the programming mode	42
2.3	FOUNDATION Fieldbus device certification	11	5.4	Error messages	42
2.4	Registered trademarks	11	5.4.1	Type of error	42
3	Installation	12	5.4.2	Error message type	42
3.1	Incoming acceptance, transport and storage	12	5.5	Operating programs	43
3.1.1	Incoming acceptance	12	5.5.1	FieldCare	43
3.1.2	Transport	12	5.5.2	Operating via FOUNDATION Fieldbus configuration programs	43
3.1.3	Storage	13	5.5.3	Device description files for operating programs	44
3.2	Installation conditions	14	5.6	FOUNDATION Fieldbus hardware settings	45
3.2.1	Dimensions	14	5.6.1	Switching hardware write protection on and off	45
3.2.2	Mounting location	14	6	Commissioning	46
3.2.3	Orientation	16	6.1	Function check	46
3.2.4	Special installation instructions	18	6.2	Switching on the measuring device	46
3.2.5	Heating	20	6.3	Commissioning via FOUNDATION Fieldbus	47
3.2.6	Thermal insulation	21	6.4	Quick Setup	52
3.2.7	Inlet and outlet runs	21	6.4.1	Quick Setup "Commissioning"	53
3.2.8	Vibrations	21	6.4.2	Quick Setup "Gas Measurement"	54
3.2.9	Limiting flow	21	6.4.3	Data backup/transmission	56
3.3	Installation	22	6.5	Device configuration	57
3.3.1	Turning the transmitter housing	22	6.5.1	Concentration measurement	57
3.3.2	Installing the wall-mount housing	23	6.5.2	Advanced diagnostic functions	62
3.3.3	Turning the local display	25	6.6	Adjustment	64
3.4	Post-installation check	25	6.6.1	Zero point adjustment	64
4	Wiring	26	6.6.2	Density adjustment	66
4.1	FOUNDATION Fieldbus cable specification	26	6.7	Gas measurement	69
4.1.1	Cable type	26	6.8	Rupture disk	70
4.1.2	Maximum overall cable length	27	6.9	Purge and pressure monitoring connections	70
4.1.3	Maximum spur length	27	6.10	Data storage device (HistoROM), F-CHIP	70
4.1.4	Number of field devices	27	6.10.1	HistoROM/S-DAT (sensor-DAT)	71
4.1.5	Shielding and grounding	27	6.10.2	HistoROM/T-DAT (transmitter-DAT)	71
4.1.6	Bus termination	28	6.10.3	F-CHIP (Function-Chip)	71
4.1.7	Further information	28	7	Maintenance	72
4.2	Connecting the remote version	29	7.1	Exterior cleaning	72
4.2.1	Connecting the connecting cable for sensor/transmitter	29	7.2	Cleaning with pigs (Promass H, I, S, P)	72
4.2.2	Cable specification, connecting cable	30	7.3	Replacing seals	72
4.3	Connecting the measuring unit	30			
4.3.1	Terminal assignment	30			
4.3.2	Connecting the transmitter	30			
4.3.3	Fieldbus connector	32			

8	Accessories	73
8.1	Device-specific accessories	73
8.2	Measuring principle-specific accessories	73
8.3	Service-specific accessories	74
9	Troubleshooting	75
9.1	Troubleshooting instructions	75
9.2	System/process error messages	79
9.2.1	List of system error messages	80
9.2.2	List of process error messages	87
9.3	Process errors without messages	89
9.4	Spare parts	90
9.5	Removing and installing electronics boards	91
9.5.1	Field housing	91
9.5.2	Wall-mount housing	93
9.6	Replacing the device fuse	95
9.7	Return	95
9.8	Disposal	96
9.9	Software history	97
10	Technical data	99
10.1	Technical data at a glance	99
10.1.1	Applications	99
10.1.2	Function and system design	99
10.1.3	Input	99
10.1.4	Output	102
10.1.5	Power supply	106
10.1.6	Performance characteristics	107
10.1.7	Operating conditions: Installation	127
10.1.8	Operating conditions: Environment	127
10.1.9	Operating conditions: Process	128
10.1.10	Mechanical construction	140
10.1.11	Operability	145
10.1.12	Certificates and approvals	146
10.1.13	Ordering information	147
10.1.14	Accessories	147
10.1.15	Supplementary documentation	147
Index	148	

1 Safety instructions

1.1 Designated use

The measuring device described in these Operating Instructions is to be used only for measuring the mass flow rate of liquids and gases. At the same time, the system also measures fluid density and fluid temperature. These parameters are then used to calculate other variables such as volume flow. Fluids with widely differing properties can be measured.

Examples:

- Oils, fats
- Acids, alkalis, lacquers, paints, solvents and cleaning agents
- Pharmaceuticals, catalysts, inhibitors
- Suspensions
- Gases, liquefied gases, etc.
- Chocolate, condensed milk, liquid sugar

Resulting from incorrect use or from use other than that designated the operational safety of the measuring devices can be suspended. The manufacturer accepts no liability for damages being produced from this.



1.2 Installation, commissioning and operation

Note the following points:

- Installation, connection to the electricity supply, commissioning and maintenance of the device must be carried out by trained, qualified specialists authorized to perform such work by the facility's owner-operator. The specialist must have read and understood these Operating Instructions and must follow the instructions they contain.
- The device must be operated by persons authorized and trained by the facility's owner-operator. Strict compliance with the instructions in these Operating Instructions is mandatory.
- Endress+Hauser will be happy to assist in clarifying the corrosion-resistant properties of materials wetted by special fluids, including fluids used for cleaning. However, minor changes in temperature, concentration or in the degree of contamination in the process may result in variations in corrosion resistance. For this reason, Endress+Hauser does not accept any responsibility with regard to the corrosion resistance of materials wetted by fluids in a specific application. The user is responsible for the choice of suitable wetted materials in the process.
- If carrying out welding work on the piping, the welding unit may not be grounded by means of the measuring device.
- The installer must ensure that the measuring system is correctly wired in accordance with the wiring diagrams. The transmitter must be earthed unless special protection measures have been taken e.g. galvanically isolated power supply SELV or PELV (SELV = Safe Extra Low Voltage; PELV = Protective Extra Low Voltage).
- Invariably, local regulations governing the opening and repair of electrical devices apply.

1.3 Operational safety

Note the following points:

- Measuring systems for use in hazardous environments are accompanied by separate "Ex documentation", which is an integral part of these Operating Instructions. Strict compliance with the installation instructions and ratings as stated in this supplementary documentation is mandatory. The symbol on the front of this supplementary Ex documentation indicates the approval and the certification body (e.g.  Europe,  USA,  Canada).
- The measuring device complies with the general safety requirements in accordance with EN 61010-1, the EMC requirements of IEC/EN 61326, and NAMUR Recommendation NE 21, NE 43 and NE 53.
- For measuring systems used in SIL 2 applications, the separate manual on functional safety must be observed.
- External surface temperature of the transmitter can increase by 10 K due to power consumption of internal electrical components. Hot process fluids passing through the measuring device will further increase the surface temperature of the measuring device. Especially the surface of the sensor can reach temperatures which are close to process temperature. Additionally safety precautions are required when increased process temperatures are present.
- The manufacturer reserves the right to modify technical data without prior notice. Your Endress+Hauser distributor will supply you with current information and updates to these Operating Instructions.

1.4 Return

- Do not return a measuring device if you are not absolutely certain that all traces of hazardous substances have been removed, e.g. substances which have penetrated crevices or diffused through plastic.
- Costs incurred for waste disposal and injury (burns, etc.) due to inadequate cleaning will be charged to the owner-operator.
- Please note the measures on →  95

1.5 Notes on safety conventions and icons

The devices are designed to meet state-of-the-art safety requirements, have been tested, and left the factory in a condition in which they are safe to operate. The devices comply with the applicable standards and regulations in accordance with EN 61010-1 "Protection Measures for Electrical Equipment for Measurement, Control, Regulation and Laboratory Procedures". The devices can, however, be a source of danger if used incorrectly or for other than the designated use. Consequently, always pay particular attention to the safety instructions indicated in these Operating Instructions by the following icons:



Warning!

"Warning" indicates an action or procedure which, if not performed correctly, can result in injury or a safety hazard. Comply strictly with the instructions and proceed with care.



Caution!

"Caution" indicates an action or procedure which, if not performed correctly, can result in incorrect operation or destruction of the device. Comply strictly with the instructions.



Note!

"Note" indicates an action or procedure which, if not performed correctly, can have an indirect effect on operation or trigger an unexpected response on the part of the device.

2 Identification

The following options are available for identification of the measuring device::

- Nameplate specifications
- Order code with breakdown of the device features on the delivery note
- Enter serial numbers from nameplates in *W@M Device Viewer* (www.endress.com/deviceviewer): All information about the measuring device is displayed.

For an overview of the scope of the Technical Documentation provided, refer to the following:

- The chapters "Supplementary documentation" →  147
- Der *W@M Device Viewer*: Enter the serial number from the nameplate (www.endress.com/deviceviewer)

Reorder

The measuring device is reordered using the order code.

Extended order code:

- The device type (product root) and basic specifications (mandatory features) are always listed.
- Of the optional specifications (optional features), only the safety and approval-related specifications are listed (e.g. LA). If other optional specifications are also ordered, these are indicated collectively using the # placeholder symbol (e.g. #LA#).
- If the ordered optional specifications do not include any safety and approval-related specifications, they are indicated by the + placeholder symbol (e.g. 8E2B50-ABCDE+).

2.1 Device designation

The "Promass 83" flow measuring system consists of the following components:

- Promass 83 transmitter.
- Promass F, Promass E, Promass A, Promass H, Promass I, Promass S, Promass P, Promass O or Promass X sensor.

Two versions are available:

- Compact version: transmitter and sensor form a single mechanical unit.
- Remote version: transmitter and sensor are installed separately.

2.1.1 Nameplate of the transmitter

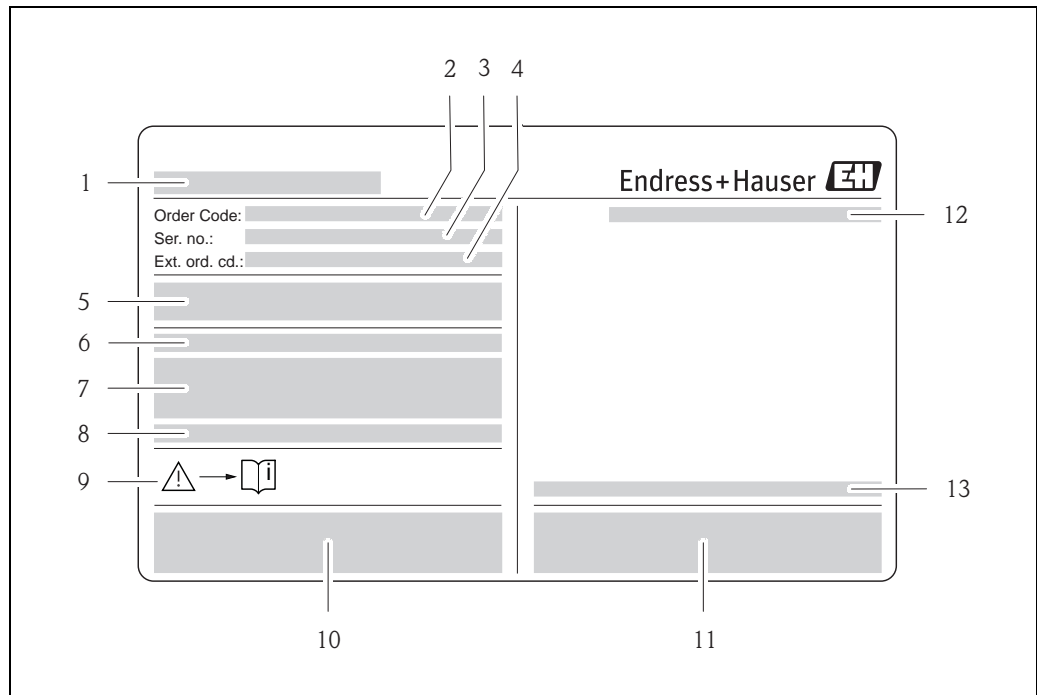

Fig. 1: Example of a transmitter nameplate

- 1 Name of the transmitter
- 2 Order code
- 3 Serial number (Ser. no.)
- 4 Extended order code (Ext. ord. cd.)
- 5 Power supply, frequency and power consumption
- 6 Additional function and software
- 7 Available inputs / outputs
- 8 Reserved for information on special products
- 9 Please refer to operating instructions / documentation
- 10 Reserved for certificates, approvals and for additional information on device version
- 11 Patents
- 12 Degree of protection
- 13 Ambient temperature range

2.1.2 Nameplate of the sensor

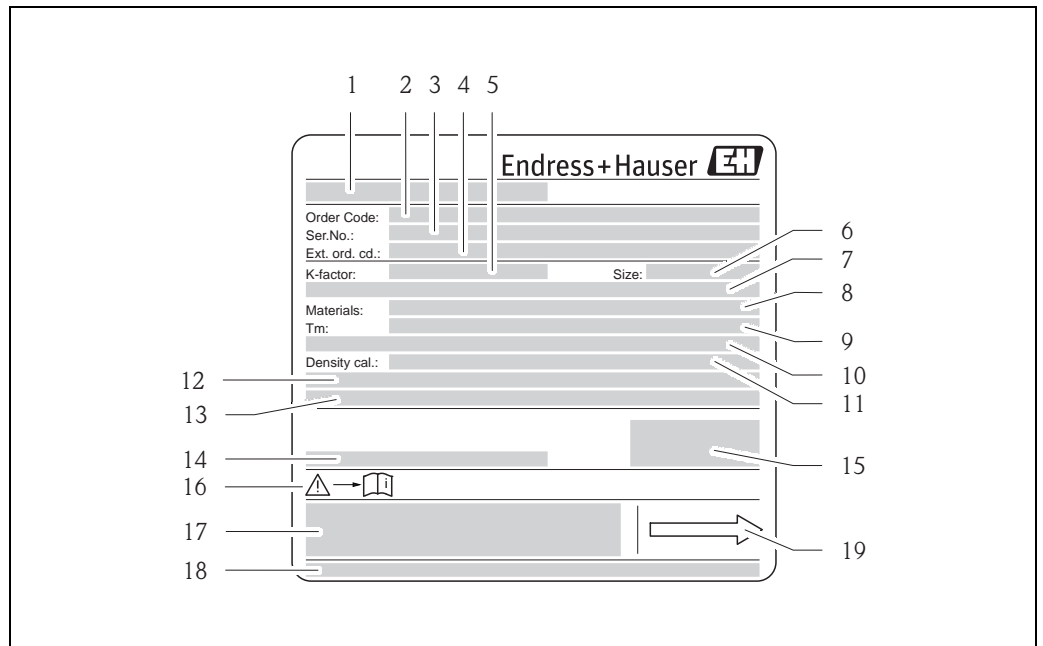
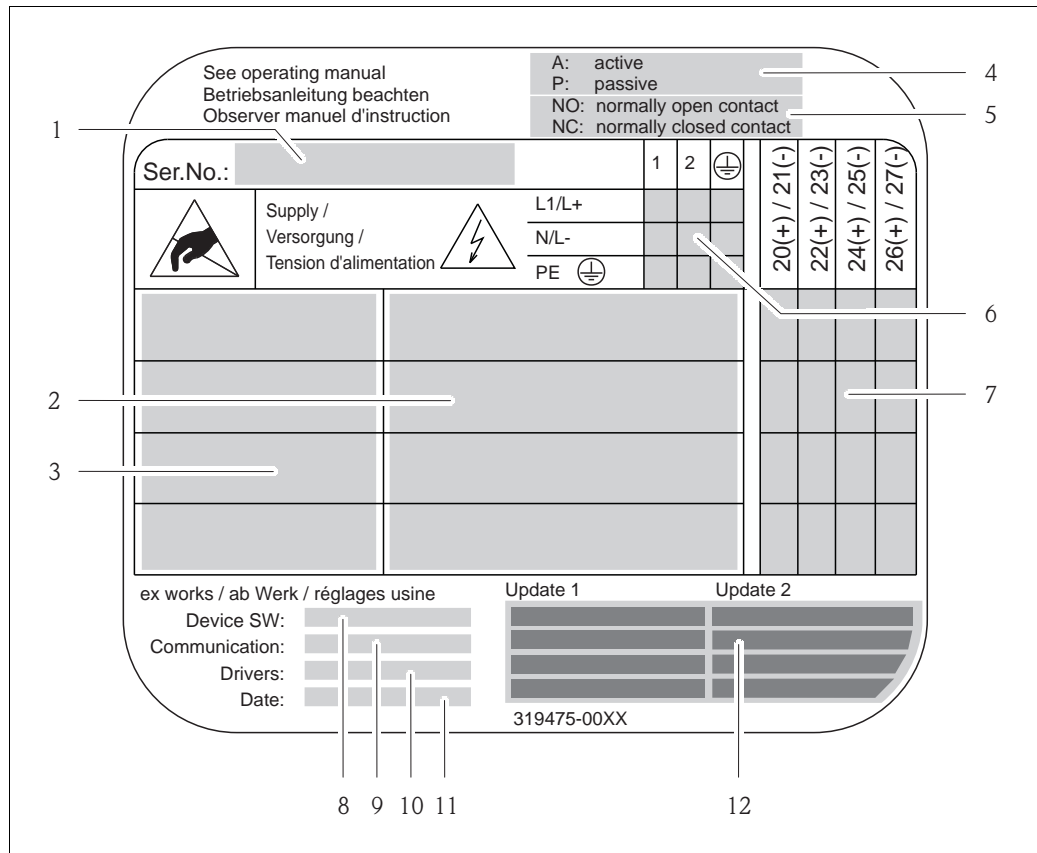

Fig. 2: Example of a sensor nameplate

- 1 Name of the sensor
- 2 Order code
- 3 Serial number (Ser. no.)
- 4 Extended order code (Ext. ord. cd.)
- 5 Calibration factor with zero point (K-factor)
- 6 Nominal diameter device (Size)
- 7 Flange nominal diameter/Nominal pressure
- 8 Material of measuring tubes (Materials)
- 9 Max. fluid temperature (Tm)
- 10 Pressure range of secondary containment
- 11 Accuracy of density measurement (Density cal.)
- 12 Additional information
- 13 Reserved for information on special products
- 14 Ambient temperature range
- 15 Degree of protection
- 16 Please refer to operating instructions / documentation
- 17 Reserved for additional information on device version (approvals, certificates)
- 18 Patents
- 19 Flow direction

2.1.3 Nameplate for connections



A0015931

Fig. 3: Example of a connection nameplate

- 1 Serial number (Ser.No.)
- 2 Possible inputs and outputs
- 3 Signals present at inputs and outputs
- 4 Possible configuration of current output
- 5 Possible configuration of relay contacts
- 6 Terminal assignment, cable for power supply
- 7 Terminal assignment and configuration (see point 4 and 5) of inputs and outputs
- 8 Version of device software currently installed (Device SW)
- 9 Installed communication type (Communication)
- 10 Information on current communication software (Drivers: Device Revision and Device Description),
- 11 Date of installation (Date)
- 12 Current updates to data specified in points 8 to 11 (Update1, Update 2)

2.2 Certificates and approvals

The devices are designed in accordance with good engineering practice to meet state-of-the-art safety requirements, have been tested, and left the factory in a condition in which they are safe to operate. See also "Certificates and approvals" →  146.

The devices comply with the applicable standards and regulations in accordance with EN 61010-1 "Protection Measures for Electrical Equipment for Measurement, Control, Regulation and Laboratory Procedures" and with the EMC requirements of IEC/EN 61326.

The measuring system described in these Operating Instructions thus complies with the statutory requirements of the EC Directives. Endress+Hauser confirms successful testing of the device by affixing to it the CE mark.

The measuring system meets the EMC requirements of the "Australian Communications and Media Authority (ACMA)".

2.3 FOUNDATION Fieldbus device certification

The flowmeter has passed all the test procedures implemented and has been certified and registered by the Fieldbus FOUNDATION. The flowmeter thus meets all the requirements of the specifications listed below:

- Certified to FOUNDATION fieldbus specification
- The flowmeter meets all the specifications of the FOUNDATION Fieldbus-H1.
- Interoperability Test Kit (ITK), revision 5.01: The device can also be operated in conjunction with other-make certified devices.
- Physical Layer Conformance Test by Fieldbus Foundation

2.4 Registered trademarks

KALREZ® and VITON®

Registered trademarks of E.I. Du Pont de Nemours & Co., Wilmington, USA

TRI-CLAMP®

Registered trademark of Ladish & Co., Inc., Kenosha, USA

SWAGELOK®

Registered trademark of Swagelok & Co., Solon, USA

FOUNDATION™ Fieldbus

Registered trademark of the Fieldbus FOUNDATION, Austin, USA

HistoROM™, S-DAT®, T-DAT™, F-CHIP®, FieldCare®, Fieldcheck®, Applicator®

Registered or registration-pending trademarks of Endress+Hauser Flowtec AG, Reinach, CH

3 Installation

3.1 Incoming acceptance, transport and storage



3.1.1 Incoming acceptance

On receipt of the goods, check the following points:

- Check the packaging and the contents for damage.
- Check the shipment, make sure nothing is missing and that the scope of supply matches your order.

3.1.2 Transport

The following instructions apply to unpacking and to transporting the device to its final location:

- Transport the devices in the containers in which they are delivered.
- The covers or caps fitted to the process connections prevent mechanical damage to the sealing faces and the ingress of foreign matter to the measuring tube during transportation and storage. Consequently, do not remove these covers or caps until immediately before installation.
- Do not lift measuring devices of nominal diameters $> \text{DN } 40$ ($> 1\frac{1}{2}$ ") by the transmitter housing or the connection housing in the case of the remote version (\rightarrow  4). - Use webbing slings slung round the two process connections. Do not use chains, as they could damage the housing.
- Promass X, Promass O sensor: see special instructions for transporting \rightarrow  13



Warning!

Risk of injury if the measuring device slips. The center of gravity of the assembled measuring device might be higher than the points around which the slings are slung.

At all times, therefore, make sure that the device does not unexpectedly turn around its axis or slip.

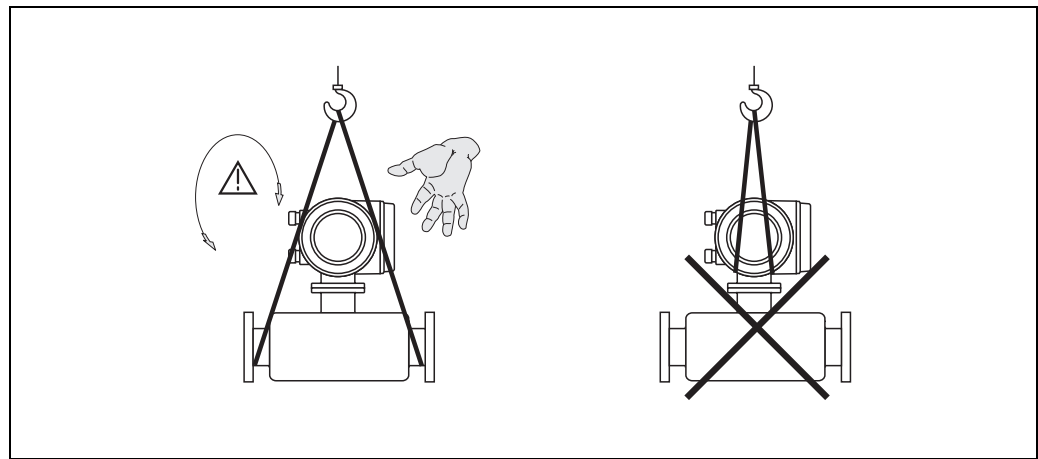

Fig. 4: Instructions for transporting sensors with $> \text{DN } 40$ ($> 1\frac{1}{2}$ ")

40004294

Special instructions for transporting Promass X and O



Warning!

- For transporting use only the lifting eyes on the flanges to lift the assembly.
- The assembly must always be attached to at least two lifting eyes.

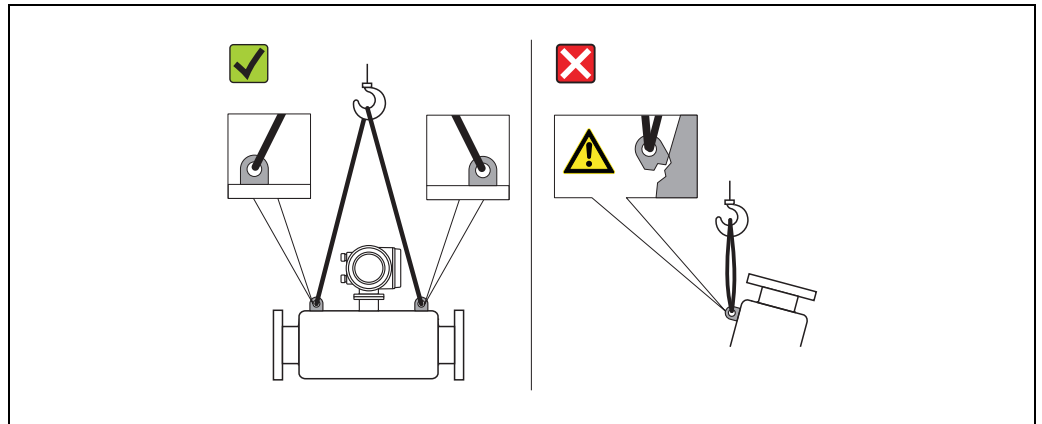

Fig. 5: Instructions for transporting Promass O

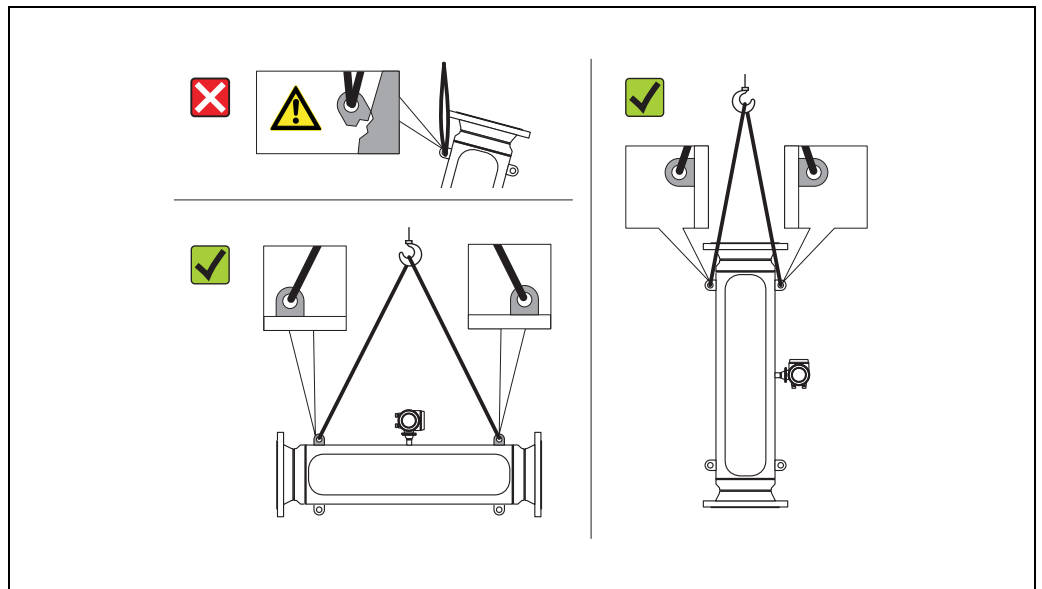

Fig. 6: Instructions for transporting Promass X

3.1.3 Storage

Note the following points:

- Pack the measuring device in such a way as to protect it reliably against impact for storage (and transportation). The original packaging provides optimum protection.
- The permissible storage temperature is -40 to $+80$ °C (-40 °F to $+176$ °F), preferably $+20$ °C ($+68$ °F).
- Do not remove the protective covers or caps on the process connections until you are ready to install the device.
- The measuring device must be protected against direct sunlight during storage in order to avoid unacceptably high surface temperatures.

3.2 Installation conditions

Note the following points:

- No special measures such as supports are necessary. External forces are absorbed by the construction of the instrument, for example the secondary containment.
- The high oscillation frequency of the measuring tubes ensures that the correct operation of the measuring system is not influenced by pipe vibrations.
- No special precautions need to be taken for fittings which create turbulence (valves, elbows, T-pieces, etc.), as long as no cavitation occurs.
- For mechanical reasons and in order to protect the pipe, it is advisable to support heavy sensors.

3.2.1 Dimensions

All the dimensions and lengths of the sensor and transmitter are provided in the separate documentation "Technical Information"

3.2.2 Mounting location

Entrained air or gas bubbles forming in the measuring tube can result in an increase in measuring errors.

Avoid the following locations in the pipe installation:

- Highest point of a pipeline. Risk of air accumulating.
- Directly upstream of a free pipe outlet in a vertical pipeline.

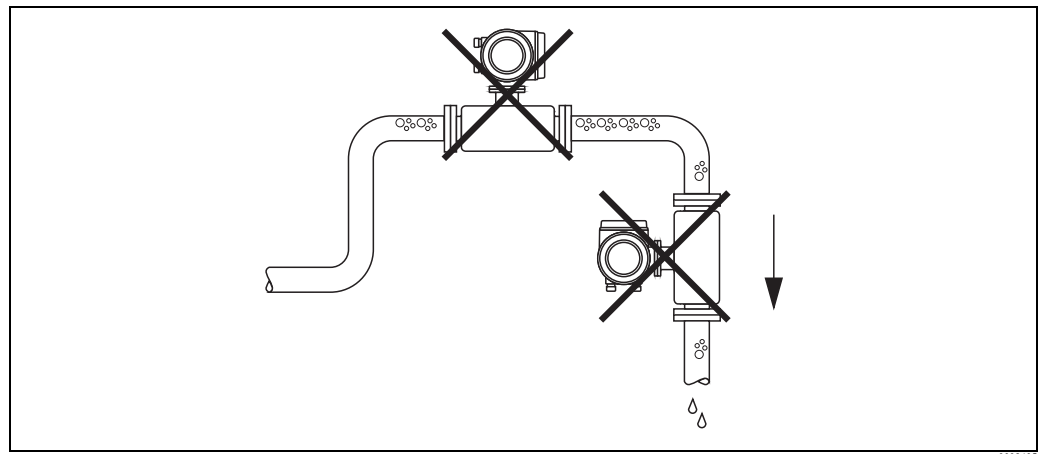

Fig. 7: Mounting location

a0003605

Installation in a vertical pipe

The proposed configuration in the following diagram, however, permits installation in a vertical pipeline. Pipe restrictors or the use of an orifice plate with a smaller cross-section than the nominal diameter prevent the sensor from running empty during measurement.

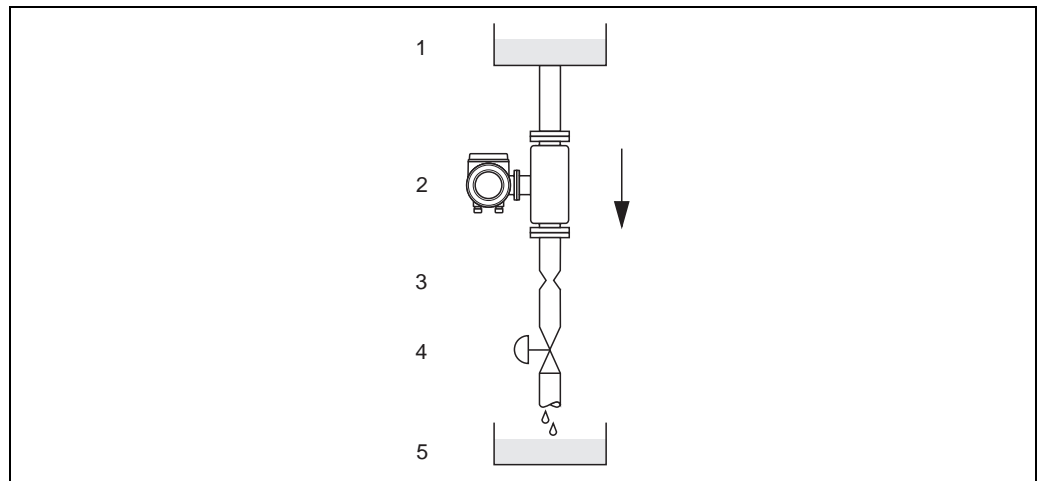

Fig. 8: Installation in a vertical pipe (e.g. for batching applications)

1 = Supply tank, 2 = Sensor, 3 = Orifice plate, pipe restrictors (see Table), 4 = Valve, 5 = Batching tank

DN		Ø Orifice plate, pipe restrictor	
		mm	inch
1	1/24"	0.8	0.03
2	1/12"	1.5	0.06
4	1/8"	3.0	0.12
8	3/8"	6	0.24
15	1/2"	10	0.40
15 FB	1/2"	15	0.60
25	1"	14	0.55
25 FB	1"	24	0.95
40	1 1/2"	22	0.87

DN		Ø Orifice plate, pipe restrictor	
		mm	inch
40 FB	1 1/2"	35	1.38
50	2"	28	1.10
50 FB	2"	54	2.00
80	3"	50	2.00
100	4"	65	2.60
150	6"	90	3.54
250	10"	150	5.91
350	14"	210	8.27

FB = Full bore versions of Promass I

System pressure

It is important to ensure that cavitation does not occur, because it would influence the oscillation of the measuring tube. No special measures need to be taken for fluids which have properties similar to water under normal conditions.

In the case of liquids with a low boiling point (hydrocarbons, solvents, liquefied gases) or in suction lines, it is important to ensure that pressure does not drop below the vapor pressure and that the liquid does not start to boil. It is also important to ensure that the gases that occur naturally in many liquids do not outgas. Such effects can be prevented when system pressure is sufficiently high.

For this reason, the following installation locations are preferred:

- Downstream from pumps (no danger of vacuum)
- At the lowest point in a vertical pipe.

3.2.3 Orientation

Make sure that the direction of the arrow on the nameplate of the sensor matches the direction of flow direction in which the fluid flows through the pipe.

Orientation Promass A

Vertical

Recommended orientation with direction of flow upwards. When fluid is not flowing, entrained solids will sink down and gases will rise away from the measuring tube. The measuring tubes can be completely drained and protected against solids build-up.

Horizontal

When installation is correct the transmitter housing is above or below the pipe. This means that no gas bubbles or solids deposits can form in the bent measuring tube (single-tube system).

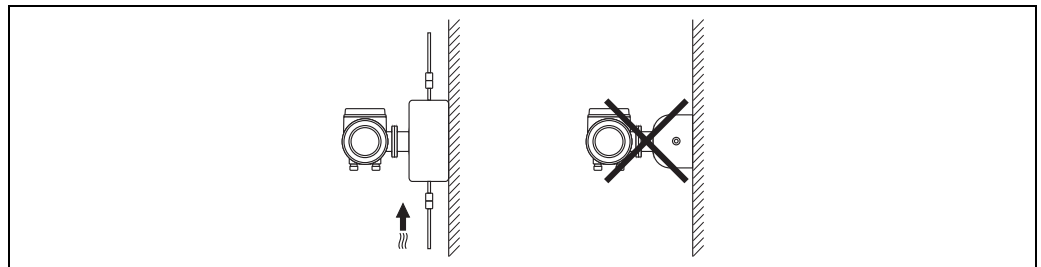

A0018978

Special installation instructions for Promass A



Caution!

Risk of measuring pipe fracture if sensor installed incorrectly!

The sensor may not be installed in a pipe as a freely suspended sensor:

- Using the base plate, mount the sensor directly on the floor, the wall or the ceiling.
- Support the sensor on a firmly mounted support base (e.g. angle bracket).

Vertical

We recommend two installation versions when mounting vertically:

- Mounted directly on a wall using the base plate
- Measuring device supported on an angle bracket mounted on the wall

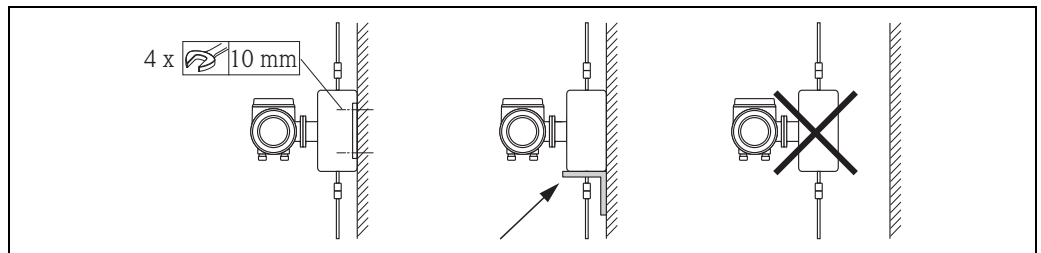

A0018980

Horizontal

We recommend the following installation version when mounting horizontally:

- Measuring device standing on a firm support base

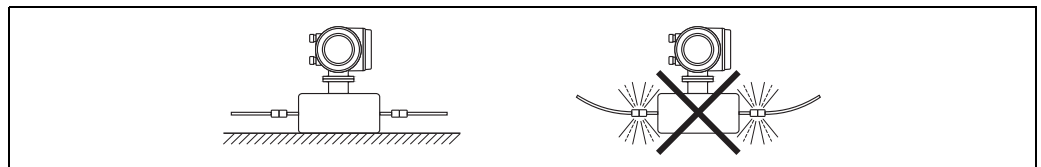

A0018979

Orientation Promass F, E, H, I, S, P, O, X

Make sure that the direction of the arrow on the nameplate of the sensor matches the direction of flow (direction in which the fluid flows through the pipe).

Vertical:

Recommended orientation with upward direction of flow (Fig. V). When fluid is not flowing, entrained solids will sink down and gases will rise away from the measuring tube.

The measuring tubes can be completely drained and protected against solids buildup.

Horizontal (Promass F, E, O):

The measuring tubes of Promass F, E and O must be horizontal and beside each other.

When installation is correct the transmitter housing is above or below the pipe (Fig. H1/H2).

Always avoid having the transmitter housing in the same horizontal plane as the pipe.

See next chapter - special installation instructions.

Horizontal (Promass H, I, S, P, X):

Promass H, I, S, P and X can be installed in any orientation in a horizontal pipe run.

Promass H, I, S, P: See next chapter - special installation instructions

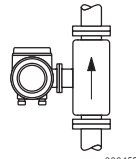
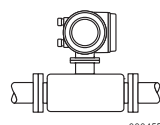
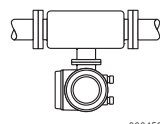
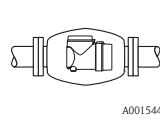
	Promass F, E, O Standard, compact	Promass F, E Standard, remote	Promass F High-temperature, compact	Promass F High-temperature, remote	Promass H, I, S, P	Promass X
Abb. V: Vertical orientation  a0004572	✓✓	✓✓	✓✓	✓✓	✓✓	✓✓
Abb. H1: Horizontal orientation Transmitter head up  a0004576	✓✓	✓✓	✗ TM > 200 °C (392 °F)	✓ TM > 200 °C (392 °F)	✓✓	✓✓
Abb. H2: Horizontal orientation Transmitter head down  a0004580	✓✓	✓✓	✓✓	✓✓	✓✓	✓✓
Abb. H3: Horizontal orientation Transmitter head to the side  A0015445	✗	✗	✗	✗	✓✓	✓ ^①
✓✓ = Recommended orientation; ✓ = Orientation recommended in certain situations; ✗ = Impermissible orientation ① The measuring tubes are curved. Therefore the unit is installed horizontally, adapt the sensor position to the fluid properties: <ul style="list-style-type: none"> ■ Suitable to a limited extent for fluids with entrained solids. Risk of solids accumulating ■ Suitable to a limited extent for outgassing fluids. Risk of air accumulating 						

In order to ensure that the permissible ambient temperature range for the transmitter (→ 127) is not exceeded, we recommend the following orientations:

- For fluids with very high temperatures we recommend the horizontal orientation with the transmitter head pointing downwards (Fig. H2) or the vertical orientation (Fig. V).
- For fluids with very low temperatures, we recommend the horizontal orientation with the transmitter head pointing upwards (Fig. H1) or the vertical orientation (Fig. V).

3.2.4 Special installation instructions

Promass F, E, H, S, P and O



Caution!

If the measuring tube is curved and the unit is installed horizontally, adapt the sensor position to the fluid properties.

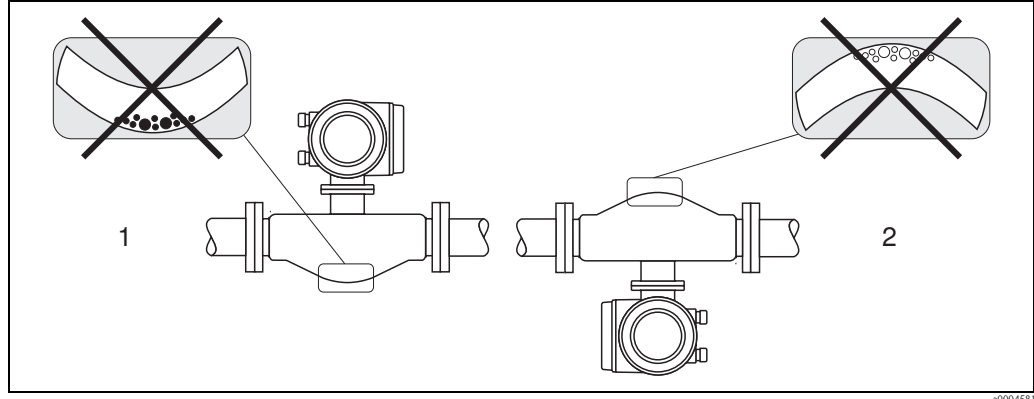

Fig. 9: Horizontal installation of sensors with curved measuring tube.

- 1 Not suitable for fluids with entrained solids. Risk of solids accumulating.
- 2 Not suitable for outgassing fluids. Risk of air accumulating.

Promass I and P with Eccentric Tri-clamps

Eccentric Tri-Clamps can be used to ensure complete drainability when the sensor is installed in a horizontal line. When lines are pitched in a specific direction and at a specific slope, gravity can be used to achieve complete drainability. The sensor must be installed in the correct position with the tube bend facing to the side, to ensure full drainability in the horizontal position. Markings on the sensor show the correct mounting position to optimize drainability.

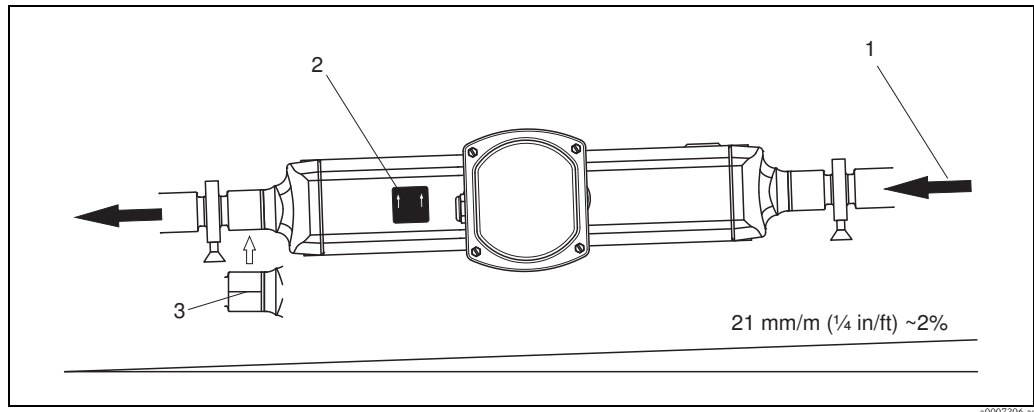

Fig. 10: Promass P: When lines are pitched in a specific direction and at a specific slope: as per hygienic guidelines (21 mm/m or approximately 2%). Gravity can be used to achieve complete drainability.

- 1 The arrow indicates the direction of flow (direction of fluid flow through the pipe).
- 2 The label shows the installation orientation for horizontal drainability.
- 3 The underside of the process connection is indicated by a scribed line. This line indicates the lowest point of the eccentric process connection.

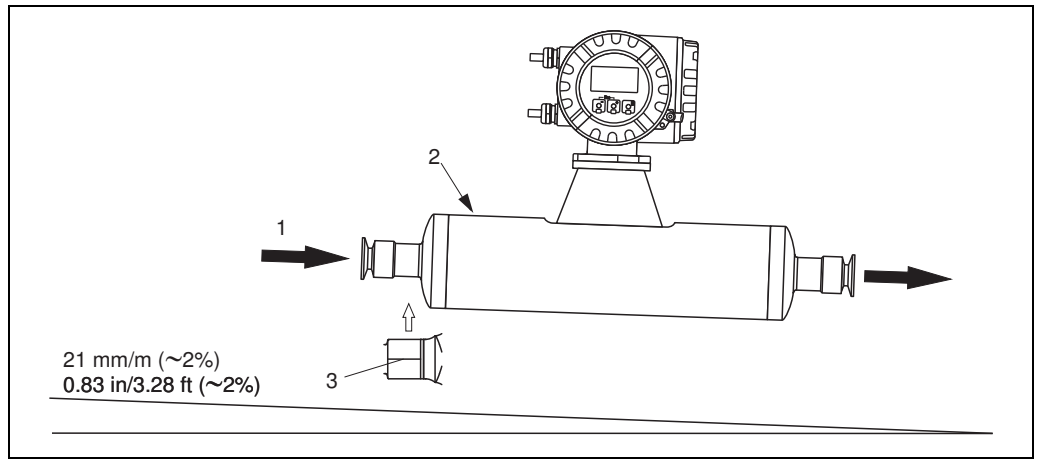

Fig. 11: Promass I: When lines are pitched in a specific direction and at a specific slope: as per hygienic guidelines (21 mm/m or approximately 2%). Gravity can be used to achieve complete drainability.

- 1 The arrow indicates the direction of flow (direction of fluid flow through the pipe).
- 2 The label shows the installation orientation for horizontal drainability.
- 3 The underside of the process connection is indicated by a scribed line. This line indicates the lowest point of the eccentric process connection.

**Promass I and P with hygienic connections
(mounting clamp with lining between clamp and instrument)**

It is not necessary to support the sensor under any circumstances for operational performance. If the requirement exists to support the sensor the following recommendation should be followed.

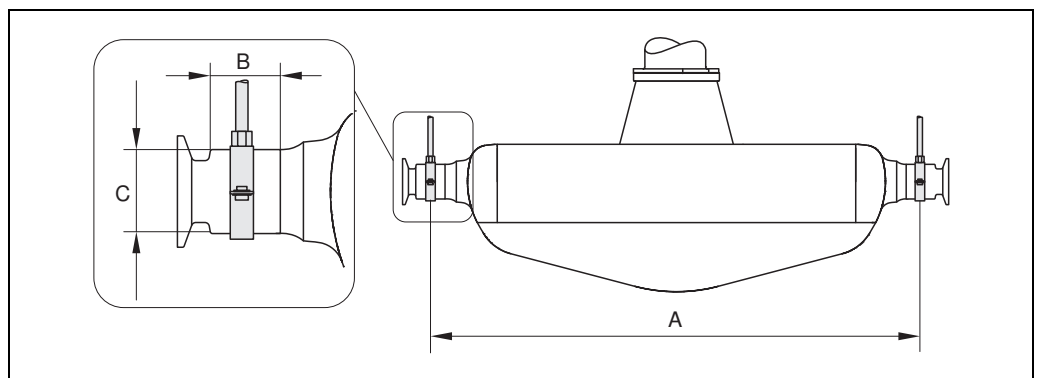

Fig. 12: Promass P, mounted with mounting clamp

DN	8	15	25	40	50
A	298	402	542	750	1019
B	33	33	33	36.5	44.1
C	28	28	38	56	75

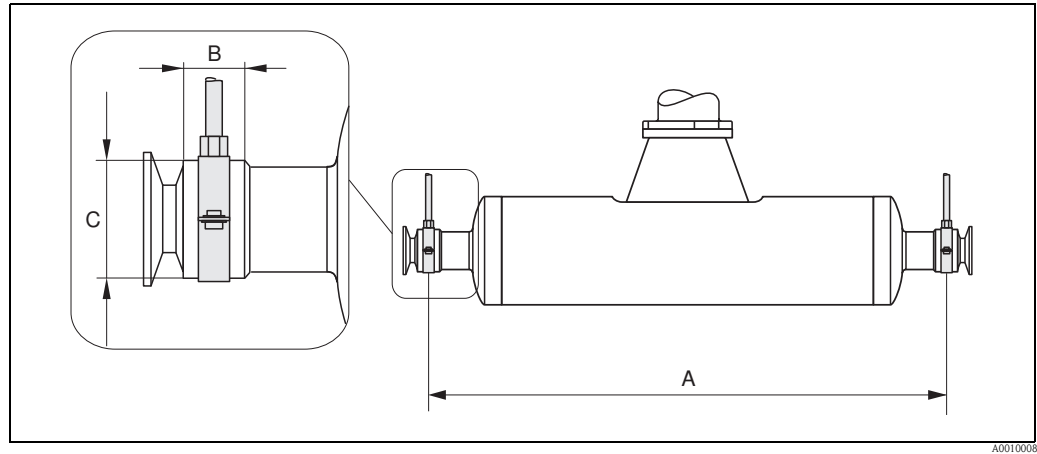

Fig. 13: Promass I, mounted with mounting clamp

DN	8	15	15FB	25	25FB	40	40FB	50	50FB	50FB	80	80
Tri-Clamp	½"	¾"	1"	1"	1 ½"	1 ½"	2"	2"	2 ½"	3"	2 ½"	3"
A	373	409	539	539	668	668	780	780	1152	1152	1152	1152
B	20	20	30	30	28	28	35	35	57	57	57	57
C	40	40	44.5	44.5	60	60	80	80	90	90	90	90

3.2.5 Heating

Some fluids require suitable measures to avoid loss of heat at the sensor. Heating can be electric, e.g. with heated elements, or by means of hot water or steam pipes made of copper or heating jackets.



Caution!

- Risk of electronics overheating! Make sure that the maximum permissible ambient temperature for the transmitter is not exceeded. Consequently, make sure that the adapter between sensor and transmitter and the connection housing of the remote version always remain free of insulating material. Note that a certain orientation might be required, depending on the fluid temperature → 16. For fluid temperature of 150°C (302°F) or above the usage of the remote version with separate connection housing is recommended.

- With a fluid temperature between 200 °C to 350 °C (392 to 662 °F) the remote version of the high-temperature version is preferable.

- When using electrical heat tracing whose heat is regulated using phase control or by pulse packs, it cannot be ruled out that the measured values are influenced by magnetic fields which may occur, (i.e. at values greater than those permitted by the EC standard (Sinus 30 A/m)). In such cases, the sensor must be magnetically shielded.

The secondary containment can be shielded with tin plates or electric sheets without privileged direction (e.g. V330-35A) with the following properties:

- Relative magnetic permeability $\mu_r \geq 300$
- Plate thickness $d \geq 0.35 \text{ mm (0.014")}$

- Information on permissible temperature ranges → 128

- Promass X: Especially under critical climatic conditions it has to be ensured that the temperature difference between environment and measured medium does not exceed 100 K. Suitable measures, such as heating or thermal insulation, are to be taken.

Special heating jackets which can be ordered as accessories from Endress+Hauser are available for the sensors.

3.2.6 Thermal insulation

Some fluids require suitable measures to avoid loss of heat at the sensor. A wide range of materials can be used to provide the required thermal insulation.

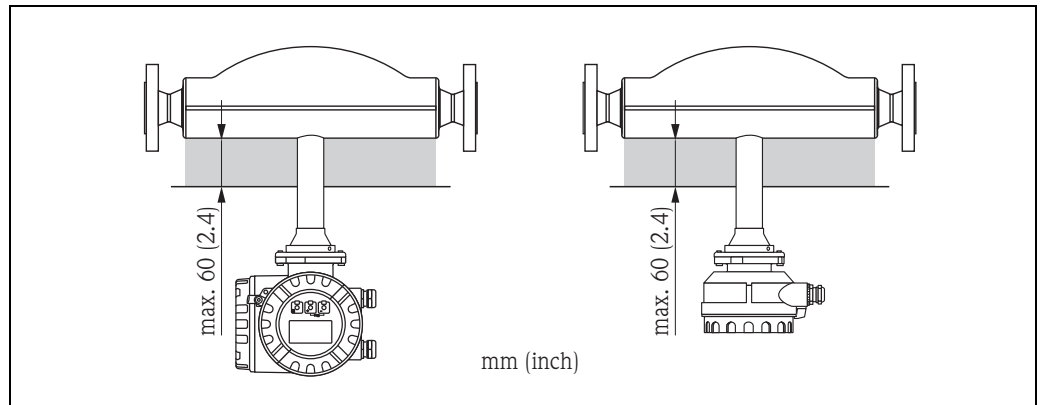

Fig. 14: In the case of the Promass F high-temperature version, a maximum insulation thickness of 60 mm (2.4") must be observed in the area of the electronics/neck.

If the Promass F high-temperature version is installed horizontally (with transmitter head pointing upwards), an insulation thickness of min. 10 mm (0.4") is recommended to reduce convection. The maximum insulation thickness of 60 mm (2.4") must be observed.

3.2.7 Inlet and outlet runs

There are no installation requirements regarding inlet and outlet runs. If possible, install the sensor well clear of fittings such as valves, T-pieces, elbows, etc.

3.2.8 Vibrations

The high oscillation frequency of the measuring tubes ensures that the correct operation of the measuring system is not influenced by pipe vibrations. Consequently, the sensors require no special measures for attachment.

3.2.9 Limiting flow

Relevant information can be found in the "Technical Data" section under "Measuring range" → 99 or "Limiting flow" → 130.

3.3 Installation

3.3.1 Turning the transmitter housing

Turning the aluminum field housing



Warning!

The turning mechanism in devices with EEx d/de or FM/CSA Cl. I Div. 1 classification is not the same as that described here. The procedure for turning these housings is described in the Ex-specific documentation.

1. Loosen the two securing screws.
2. Turn the bayonet catch as far as it will go.
3. Carefully lift the transmitter housing as far as it will go.
4. Turn the transmitter housing to the desired position (max. $2 \times 90^\circ$ in either direction).
5. Lower the housing into position and reengage the bayonet catch.
6. Retighten the two securing screws.

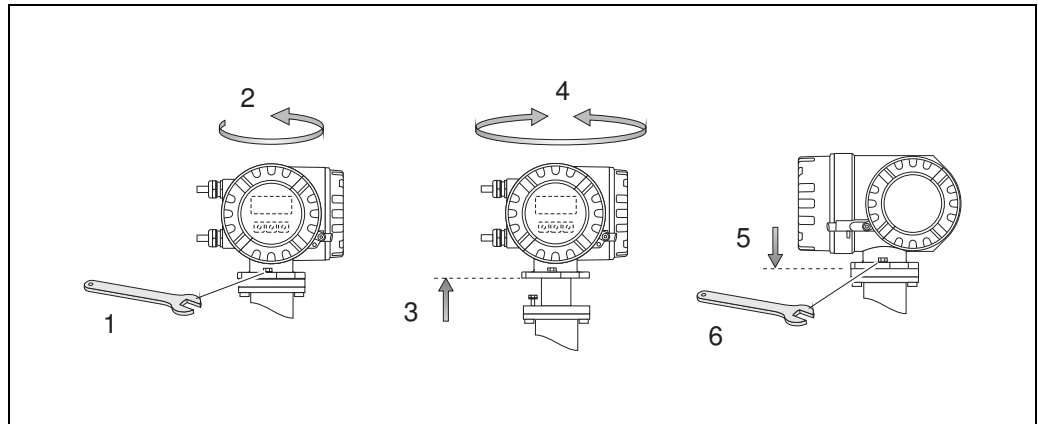

Fig. 15: Turning the transmitter housing (aluminum field housing)

Turning the stainless steel field housing

1. Loosen the two securing screws.
2. Carefully lift the transmitter housing as far as it will go.
3. Turn the transmitter housing to the desired position (max. $2 \times 90^\circ$ in either direction).
4. Lower the housing into position.
5. Retighten the two securing screws.

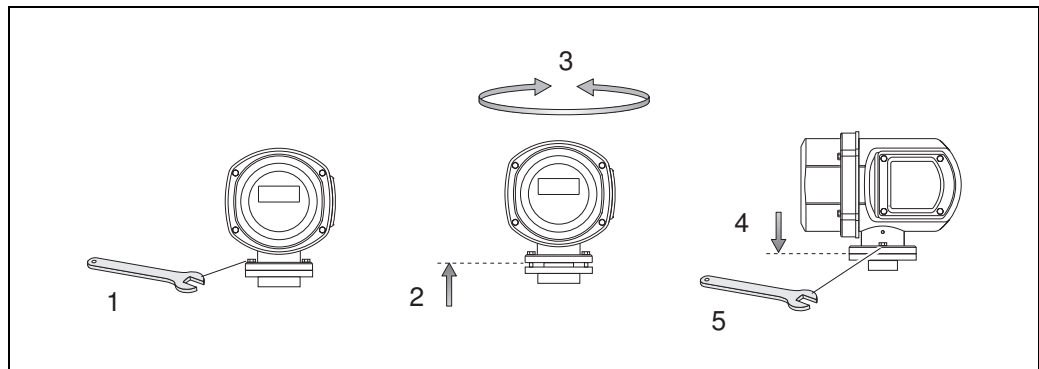

Fig. 16: Turning the transmitter housing (stainless steel field housing)

3.3.2 Installing the wall-mount housing

There are various ways of installing the wall-mount housing:

- Mounted directly on the wall
- Installation in control panel (separate mounting set, accessories) → 24
- Pipe mounting (separate mounting set, accessories) → 24



Caution!

- Make sure that ambient temperature does not go beyond the permissible range (– 20 to +60 °C (–4 to + 140 F), optional – 40 to +60 °C (–40 to +140 °F)). Install the device in a shady location. Avoid direct sunlight.
- Always install the wall-mount housing in such a way that the cable entries are pointing down.

Mounted directly on the wall

1. Drill the holes as illustrated in the diagram.
2. Remove the cover of the connection compartment (a).
3. Push the two securing screws (b) through the appropriate bores (c) in the housing.
 - Securing screws (M6): max. Ø 6.5 mm (0.26")
 - Screw head: max. Ø 10.5 mm (0.41")
4. Secure the transmitter housing to the wall as indicated.
5. Screw the cover of the connection compartment (a) firmly onto the housing.

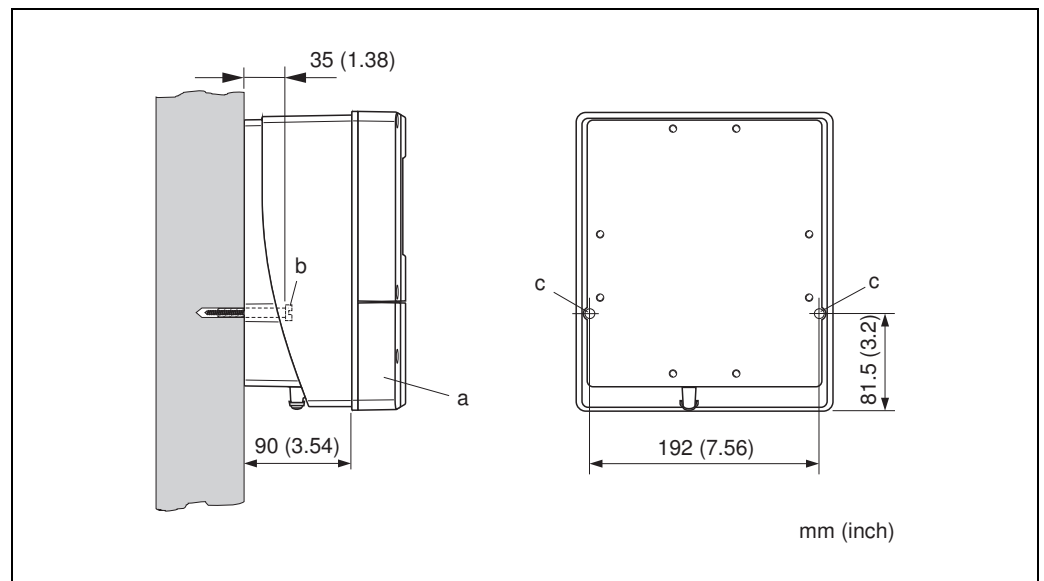

Fig. 17: Mounted directly on the wall

a0001130

Installation in control panel

1. Prepare the opening in the panel as illustrated in the diagram.
2. Slide the housing into the opening in the panel from the front.
3. Screw the fasteners onto the wall-mount housing.
4. Screw threaded rods into holders and tighten until the housing is solidly seated on the panel wall. Afterwards, tighten the locking nuts. Additional support is not necessary.

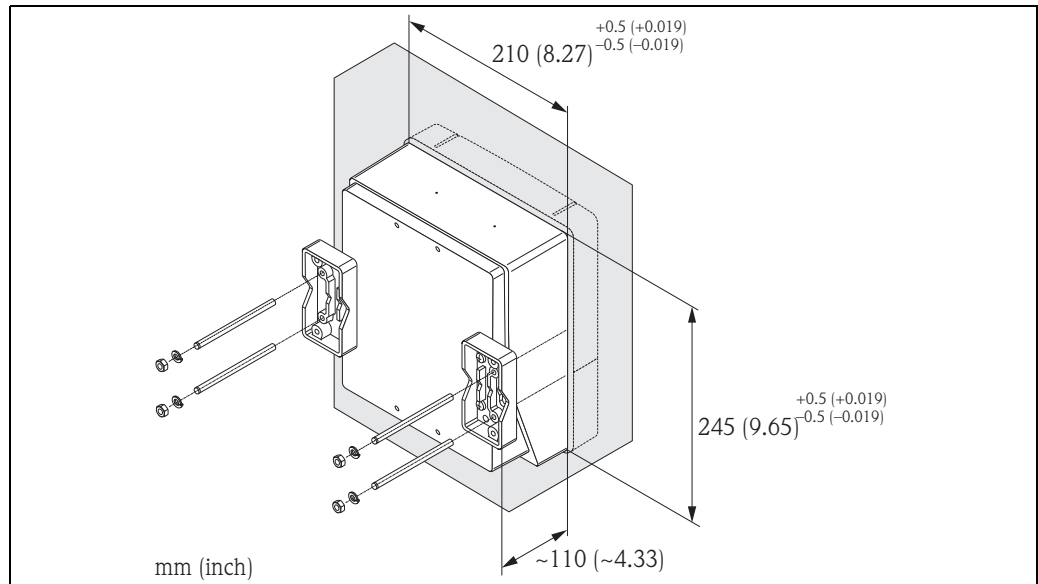

Fig. 18: Panel installation (wall-mount housing)

Pipe mounting

The assembly should be performed by following the instructions in the diagram.



Caution!

If a warm pipe is used for installation, make sure that the housing temperature does not exceed the max. permitted value of +60 °C (+140 °F).

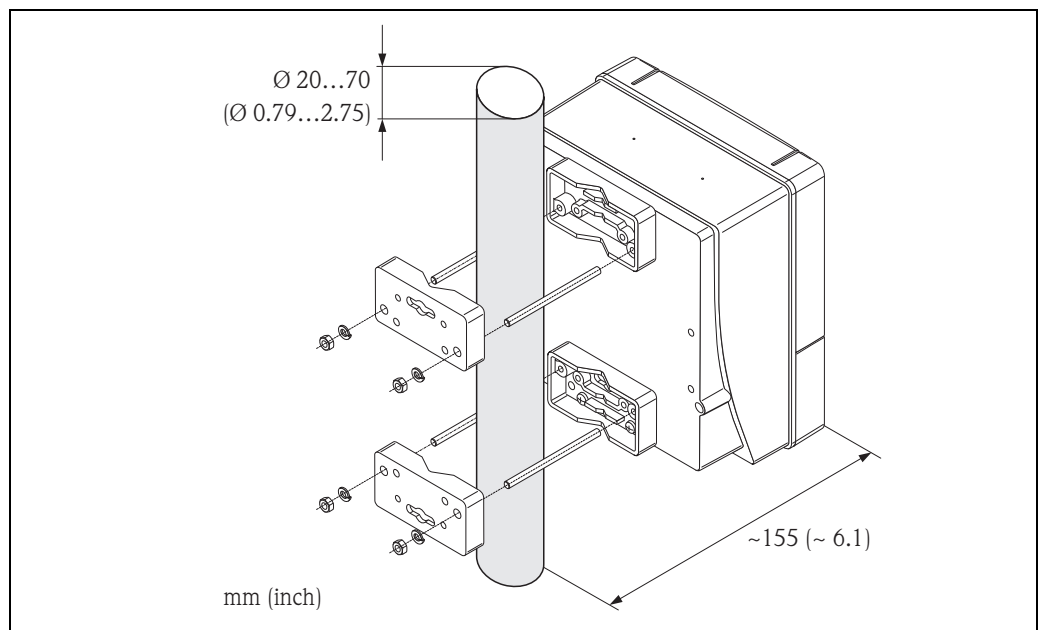

Fig. 19: Pipe mounting (wall-mount housing)

3.3.3 Turning the local display

1. Unscrew cover of the electronics compartment from the transmitter housing.
2. Press the side latches on the display module and remove the module from the electronics compartment cover plate.
3. Rotate the display to the desired position (max. $4 \times 45^\circ$ in both directions), and reset it onto the electronics compartment cover plate.
4. Screw the cover of the electronics compartment firmly back onto the transmitter housing.

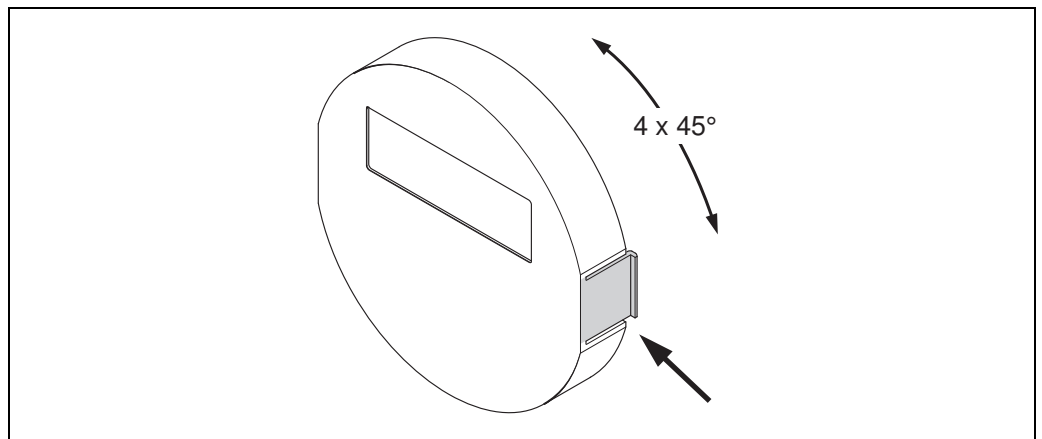

Fig. 20: Turning the local display (field housing)

3.4 Post-installation check

Perform the following checks after installing the measuring device in the pipe:

Device condition and specifications	Notes
Is the device damaged (visual inspection)?	-
Does the device correspond to specifications at the measuring point, including process temperature and pressure, ambient temperature, measuring range, etc.?	→ 5
Installation instructions	Notes
Does the arrow on the sensor nameplate match the direction of flow through the pipe?	-
Are the measuring point number and labeling correct (visual inspection)?	-
Is the orientation chosen for the sensor correct, in other words suitable for sensor type, fluid properties (outgassing, with entrained solids) and fluid temperature?	→ 14
Process environment / process conditions	Notes
Is the measuring device protected against moisture and direct sunlight?	-

4 Wiring



Warning!

When connecting Ex-certified devices, see the notes and diagrams in the Ex-specific supplement to these Operating Instructions. Please do not hesitate to contact your Endress+Hauser sales office if you have any questions.



Note!

The device does not have an internal splitter. For this reason, assign the device a switch or power-circuit breaker which can be used to disconnect the power supply line from the power grid.

4.1 FOUNDATION Fieldbus cable specification

4.1.1 Cable type

Twin-core cable is recommended for connecting the flowmeter to the FOUNDATION Fieldbus H1. By analogy with IEC 61158-2 (MBP) protocol four different cable types (A, B, C, D) can be used with the FOUNDATION Fieldbus Protocol, only two of which (cable types A and B) are shielded.

- Cable types A or B are particularly preferable for new installations. Only these types have cable shielding that guarantees adequate protection from electromagnetic interference and thus the most reliable data transfer. With cable type B more than one fieldbus (with the same degree of protection) may be operated in a cable. No other circuits are permissible in the same cable.
- Practical experience has shown that cable types C and D should not be used due to the lack of shielding, since the freedom from interference generally does not meet the requirements described in the standard.

The electrical data of the fieldbus cable has not been specified but determines important characteristics of the design of the fieldbus, such as distances bridged, number of participants, electromagnetic compatibility, etc.

	Type A	Type B
Cable structure	twisted pair, shielded	one or more twisted pairs, fully shielded
Wire size	0.8 mm ² (AWG 18)	0.32 mm ² (AWG 22)
Loop resistance (DC)	44 Ω/km	112 Ω/km
Impedance at 31.25 kHz	100 Ω ± 20%	100 Ω ± 30%
Attenuation at 39 kHz	3 dB/km	5 dB/km
Capacitive asymmetry	2 nF/km	2 nF/km
Envelope delay distortion (7.9 to 39 kHz)	1.7 μs/km	*
Shield coverage	90%	*
Max. cable length (inc. spurs >1 m)	1900 m (6233 ft)	1200 m (3937 ft)
* not specified		

Suitable fieldbus cables (Type A) from various manufacturers for the non-hazardous area are listed below:

- Siemens: 6XV1 830-5BH10
- Belden: 3076F
- Kerpen: CeL-PE/OSCR/PVC/FRLA FB-02YS(ST)YFL

4.1.2 Maximum overall cable length

The maximum network expansion depends on the type of ignition protection and the cable specifications. The overall cable length is made up of the length of the main cable and the length of all spurs >1 m (3.28 ft).

Note the following points:

- The maximum permissible overall cable length depends on the cable type used → 26.
- If repeaters are used the maximum permissible cable length is doubled!
A maximum of three repeaters are permitted between user and master.

4.1.3 Maximum spur length

The line between distribution box and field unit is described as a spur.

In the case of non Ex-rated applications the max. length of a spur depends on the number of spurs >1 m (3.28 ft):

Number of spurs	1 to 12	13 to 14	15 to 18	19 to 24	25 to 32
Max. length per spur	120 m (393 ft)	90 m (295 ft)	60 m (196 ft)	30 m (98 ft)	1 m (3.28 ft)

4.1.4 Number of field devices

According to IEC 61158-2 (MBP) a maximum of 32 field devices may be connected per fieldbus segment. However, this number may be restricted in certain circumstances (type of ignition protection, bus power option, current consumption of field device).

A maximum of four field devices can be connected to a spur.

4.1.5 Shielding and grounding

The optimum electromagnetic compatibility of the fieldbus system is guaranteed only when system components and in particular lines are shielded and the shielding provides the most complete coverage possible. Shield coverage of 90% is ideal.

Shielding should be connected as often as possible with the reference ground. The national regulations and guidelines governing the installation of electrical equipment also apply where relevant!

Where there are large differences in potential between the individual grounding points, only one point of the shielding is connected directly with the reference ground. In systems without potential equalization, cable shielding of fieldbus systems should therefore only be grounded on one side, for example at the fieldbus supply unit or at safety barriers.



Caution!

If the cable shielding is grounded at more than one point in systems without potential equalization, network frequency equalization currents can occur that damage the bus cable or the bus shielding and substantially affect signal transmission.

4.1.6 Bus termination

The start and end of each fieldbus segment are always to be terminated with a bus terminator. With various junction boxes (not Ex-rated) the bus termination can be activated via a switch. If this is not the case a separate bus terminator must be installed. Note the following points in addition:

- In the case of a branched bus segment the device furthest from the segment connector represents the end of the bus.
- If the fieldbus is extended with a repeater then the extension must also be terminated at both ends.

4.1.7 Further information

General information and further notes on connections can be found on the website (www.fieldbus.org) of the Fieldbus Foundation or in the Operating Instructions "FOUNDATION Fieldbus Overview" (acquired at: → www.endress.com → Download).

4.2 Connecting the remote version

4.2.1 Connecting the connecting cable for sensor/transmitter



Warning!

- Risk of electric shock. Switch off the power supply before opening the device. Do not install or wire the device while it is connected to the power supply. Failure to comply with this precaution can result in irreparable damage to the electronics.
- Risk of electric shock. Connect the protective ground to the ground terminal on the housing before the power supply is applied.
- You may only connect the sensor to the transmitter with the same serial number. Communication errors can occur if this is not observed when connecting the devices.

1. Remove the cover (**d**) from the connection compartment or the sensor housing.
2. Feed the connecting cable (**e**) through the appropriate cable runs.
3. Establish the connections between sensor and transmitter in accordance with the wiring diagram (→ 21 or wiring diagram inside cover).
4. Seal the connection compartment or the transmitter housing again.

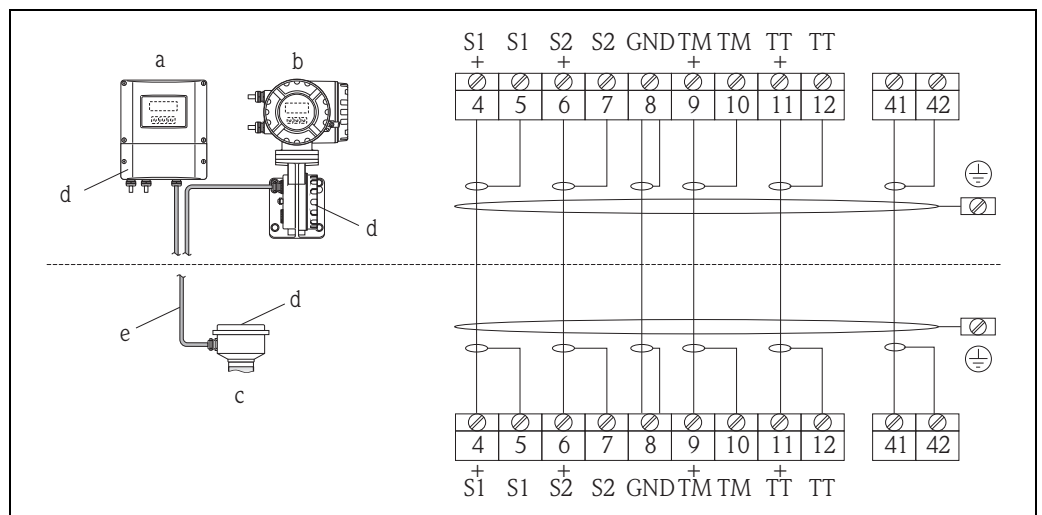

Fig. 21: Connecting the remote version

- a Wall-mount housing: non-hazardous area and ATEX II3G / Zone 2 → see separate Ex documentation
 b Wall-mount housing: ATEX II2G / Zone 1 / FM/CSA → see separate Ex documentation
 c Remote version (sensor)
 d Cover of the connection compartment or connection housing
 e Connecting cable

Terminal No.: 4/5 = gray; 6/7 = green; 8 = yellow; 9/10 = pink; 11/12 = white; 41/42 = brown

4.2.2 Cable specification, connecting cable

The specifications of the cable connecting the transmitter and the sensor of the remote version are as follows:

- $6 \times 0.38 \text{ mm}^2$ (PVC cable with common shield and individually shielded cores)
- Conductor resistance: $\leq 50 \text{ } \Omega/\text{km}$
- Capacitance: core/shield: $\leq 420 \text{ pF/m}$
- Cable length: max. 20 m (65 ft)
- Permanent operating temperature: max. $+105 \text{ } ^\circ\text{C}$ ($+221 \text{ } ^\circ\text{F}$)



Note!

The cable must be installed securely to prevent movement.

4.3 Connecting the measuring unit

Field instruments can be connected to the FOUNDATION Fieldbus in two ways:

- Connection via conventional cable gland → [30](#)
- Connection using prefabricated fieldbus connector (option) → [32](#)

4.3.1 Terminal assignment



Note!

The electrical characteristic quantities are listed in the "Technical data" section.

Order characteristic for "inputs/outputs"	Terminal No. (inputs/outputs)			
	20 (+) / 21 (-)	22 (+) / 23 (-)	24 (+) / 25 (-)	26 = FF + ¹⁾ 27 = FF - ¹⁾
G	-	-	-	FOUNDATION Fieldbus Ex i
K	-	-	-	FOUNDATION Fieldbus

¹⁾ With integrated reverse polarity protection

4.3.2 Connecting the transmitter



Warning!

- Risk of electric shock. Switch off the power supply before opening the device. Do not install or wire the device while it is connected to the power supply. Failure to comply with this precaution can result in irreparable damage to the electronics.
- Risk of electric shock. Connect the protective ground to the ground terminal on the housing before the power supply is applied (not required for galvanically isolated power supply).
- Compare the specifications on the nameplate with the local supply voltage and frequency. The national regulations governing the installation of electrical equipment also apply.

Procedure (→ [22](#)):

1. Unscrew the connection compartment cover (**a**) from the transmitter housing.
2. Feed the power supply cable (**b**) and the fieldbus cable (**d**) through the appropriate cable entries.





Note!

The device can also be supplied with the option of a ready-mounted fieldbus connector. More information → [32](#).

3. Perform wiring in accordance with the respective terminal assignment and the associated wiring diagram.

 **Caution!**

- Risk of damage to the fieldbus cable!
Observe the information about shielding and grounding the fieldbus cable →  27.
- We recommend that the fieldbus cable not be looped using conventional cable glands. If you later replace a measuring device, the bus communication will have to be interrupted.

 **Note!**

- The terminals for the fieldbus connection (26/27) have integrated reverse polarity protection. This ensures correct signal transmission via the fieldbus even if lines are confused.
- Cable cross-section: max. 2.5 mm²
- Between the stripped fieldbus cable shielding and the ground terminal (**e**), the cable shielding should not exceed a length of 5 mm (0.20 in)

4. Screw the cover of the connection compartment (**a**) back onto the transmitter housing.

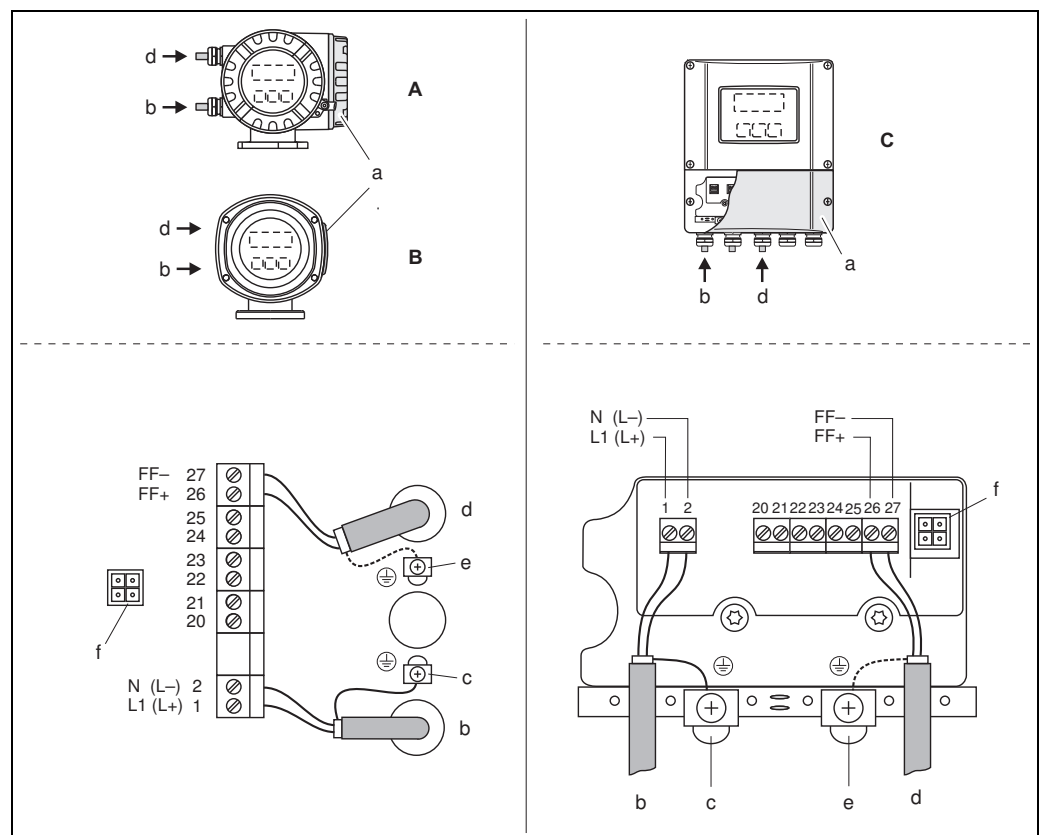



Fig. 22: Connecting the transmitter; cable cross-section: max. 2.5 mm²

- A View A (field housing)
 B View B (stainless steel field housing)
 C View C (wall-mount housing)
- a Connection compartment cover
 b Cable for power supply: 20 to 260 V AC, 20 to 64 V DC
 Terminal No. 1: L1 for AC, L+ for DC
 Terminal No. 2: N for AC, L- for DC
 c Ground terminal for protective ground
 d Fieldbus cable:
 Terminal No. 26: FF+ (with reverse polarity protection)
 Terminal No. 27: FF- (with reverse polarity protection)
 e Fieldbus cable shield ground terminal
 Observe the following:
 – The shielding and grounding of the fieldbus cable →  27
 – Make sure the stripped and twisted lengths of cable shield do not exceed a length of 5 mm (0.20 in) up to the ground terminal.
- f Service adapter for connecting service interface FXA193 (Fieldcheck, FieldCare)

4.3.3 Fieldbus connector

The connection technology of FOUNDATION Fieldbus allows measuring devices to be connected to the fieldbus via uniform mechanical connections such as T-boxes, junction boxes, etc.

This connection technology using prefabricated distribution modules and plug-in connectors offers significant advantages over conventional wiring:

- Field devices can be removed, replaced or added at any time during normal operation. Communication is not interrupted.
- This simplifies installation and maintenance significantly.
- Existing cable infrastructures can be used and expanded instantly, e.g. when constructing new star distributors using 4-channel or 8-channel junction boxes.

The device can therefore be supplied with a ready-mounted FOUNDATION Fieldbus connector. FOUNDATION Fieldbus connectors for retrofitting can be ordered from Endress+Hauser as a spare part → [73](#).

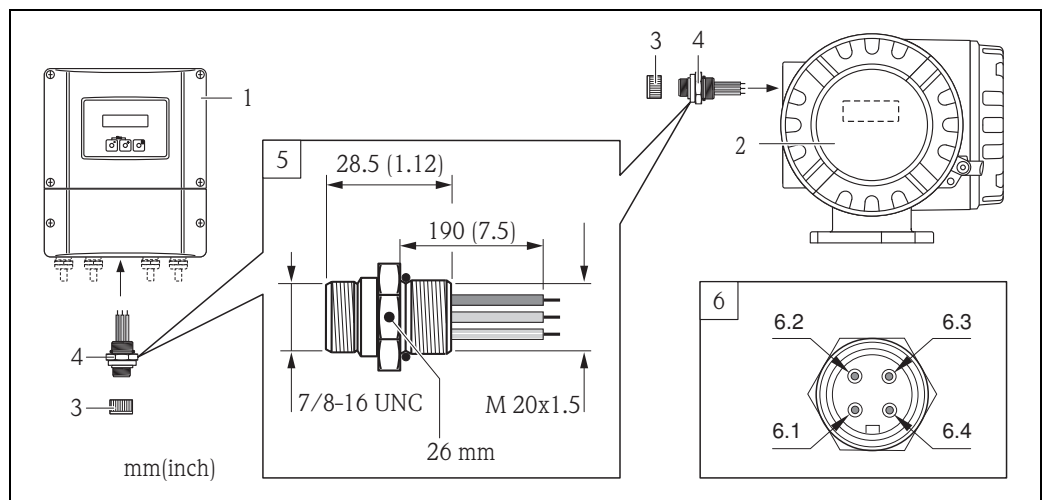

Fig. 23: Connector for connecting to the FOUNDATION Fieldbus

- 1 Wall-mount housing
- 2 Field housing
- 3 Protective cap for connector
- 4 FOUNDATION Fieldbus connector
- 5 Dimensions
- 6 FOUNDATION Fieldbus connector (pin assignment/color codes)
 - 6.1 Brown wire: FOUNDATION Fieldbus + (terminal 26)
 - 6.2 Blue wire: FOUNDATION Fieldbus - (terminal 27)
 - 6.3 Grey wire: shield, connected to ground terminal (notes on connection → [27](#), → [30](#))
 - 6.4 Not assigned

Technical data

Ambient temperature range: -40 to +105 °C (-40 to +221 °F)

Degree of protection: IP 67, only tightened with screws

Core cross section: 3 x 0.8 mm²

Housing material: stainless steel, 1.4401, 316

Contacts: metal, CuZn, gold-plated

Contact carriers: plastic, TPU, black

4.4 Degree of protection

The measuring device fulfill all the requirements for IP 67.

Compliance with the following points is mandatory following installation in the field or servicing, in order to ensure that IP 67 protection is maintained:

- The housing seals must be clean and undamaged when inserted into their grooves. The seals must be dried, cleaned or replaced if necessary.
- The threaded fasteners and screw covers must be firmly tightened.
- The cables used for connection must be of the specified outside diameter → 106, cable entries.
- The cable entries must be firmly tighten (point **a** → 24).
- The cable must loop down in front of the cable entry ("water trap") (point **b** → 24). This arrangement prevents moisture penetrating the entry.



Note!

The cable entries may not be point up.

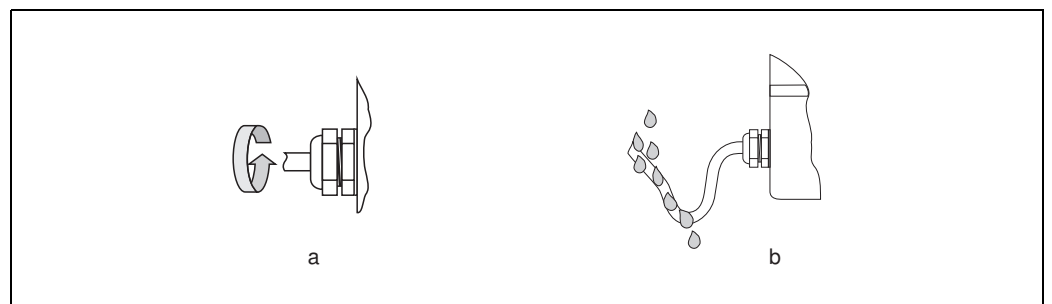

Fig. 24: Installation instructions, cable entries

- Do not remove the grommet from the cable entry.
- Remove all unused cable entries and insert plugs instead.







Caution!

Do not loosen the screws of the sensor housing, as otherwise the degree of protection guaranteed by Endress+Hauser no longer applies.

4.5 Post-connection check

Perform the following checks after completing electrical installation of the measuring device:

Device condition and specifications	Notes
Are cables or the device damaged (visual inspection)?	-
Electrical connection	Notes
Does the supply voltage match the specifications on the nameplate?	85 to 260 V AC (45 to 65 Hz) 20 to 55 V AC (45 to 65 Hz) 16 to 62 V DC
Do the cables comply with the specifications?	→  26
Do the cables have adequate strain relief?	-
Is the cable type route completely isolated? Without loops and crossovers?	-
Are the power supply and signal cables correctly connected?	See the wiring diagram inside the cover of the terminal compartment
Are all screw terminals firmly tightened?	-
Are all cable entries installed, firmly tightened and correctly sealed? Cables looped as "water traps"?	→  33
Are all housing covers installed and firmly tightened?	-
Electrical connection of FOUNDATION Fieldbus	Notes
Are all the connecting components (T-boxes, junction boxes, connectors, etc.) connected with each other correctly?	-
Has each fieldbus segment been terminated at both ends with a bus terminator?	-
Has the max. length of the fieldbus cable been observed in accordance with the FOUNDATION Fieldbus specifications?	→  27
Has the max. length of the spurs been observed in accordance with the FOUNDATION Fieldbus specifications?	→  27
Is the fieldbus cable fully shielded (90%) and correctly grounded?	→  27

5 Operation

5.1 Quick operation guide

You have a number of options for configuring and commissioning the flowmeter:

1. **Local display (option)** → 36
The local display enables you to read all important parameters directly at the measuring point, configure device-specific parameters in the field and perform commissioning.
2. **Operating programs** → 43
FOUNDATION Fieldbus functions and device-specific parameters are configured primarily via the fieldbus interface. You can obtain special configuration and operating programs from the various manufacturers for these purposes.
3. **Jumpers for diverse hardware settings** → 45
Jumpers on the I/O board provide the means of setting the following hardware parameters for the FOUNDATION Fieldbus:
 - Enabling/disabling the simulation mode in the Function Blocks (e.g. AI, DO Function Block)
 - Switching hardware write protection on and off

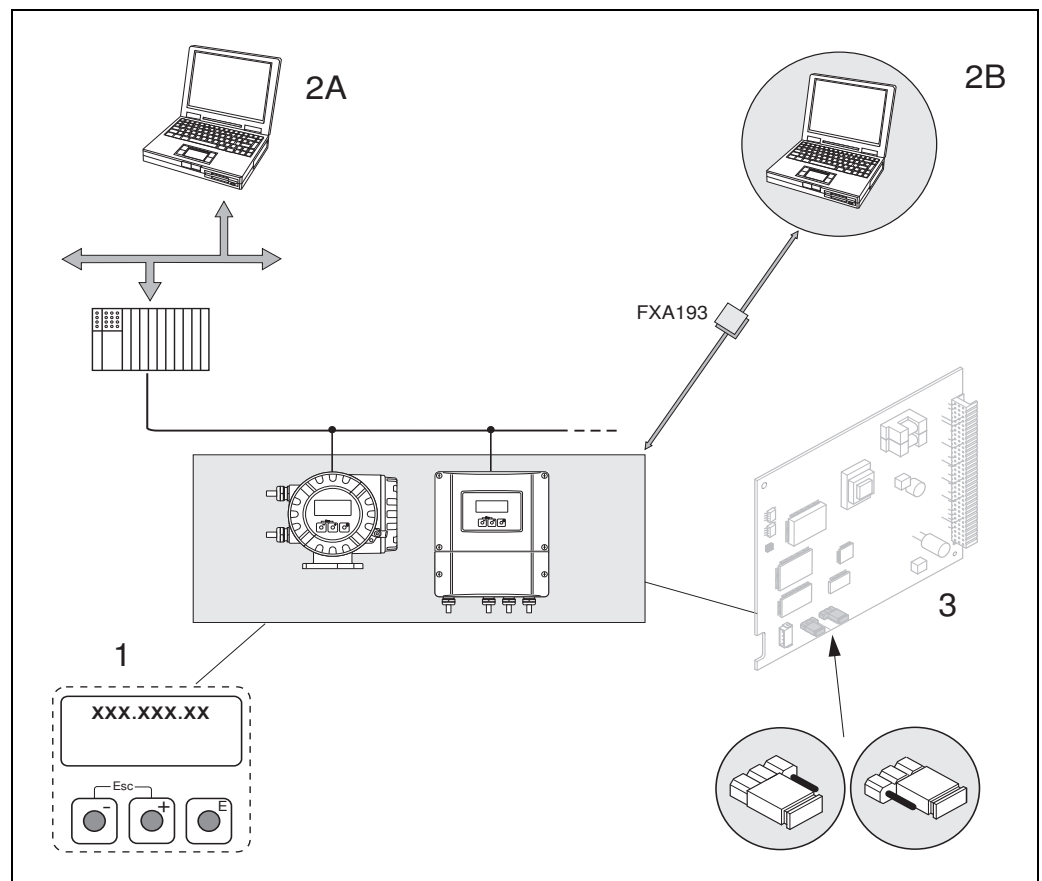

Fig. 25: FOUNDATION Fieldbus operating options

- 1 Local display for device operation in the field (option)
- 2A Configuration/operating programs for operating via the FOUNDATION Fieldbus (FF functions, device parameters)
- 2B Configuration/operating program for operating via the FXA193 service interface (e.g. FieldCare)
- 3 Jumper/miniature switches for hardware settings (write protection, simulation mode)

5.2 Local display

5.2.1 Display and operating elements

The local display enables you to read all important parameters directly at the measuring point and configure the device using the "Quick Setup" or the function matrix.

The display consists of four lines; this is where measured values and/or status variables (direction of flow, empty pipe, bar graph, etc.) are displayed. You can change the assignment of display lines to different variables to suit your needs and preferences (→ See the "Description of Device Functions" manual).

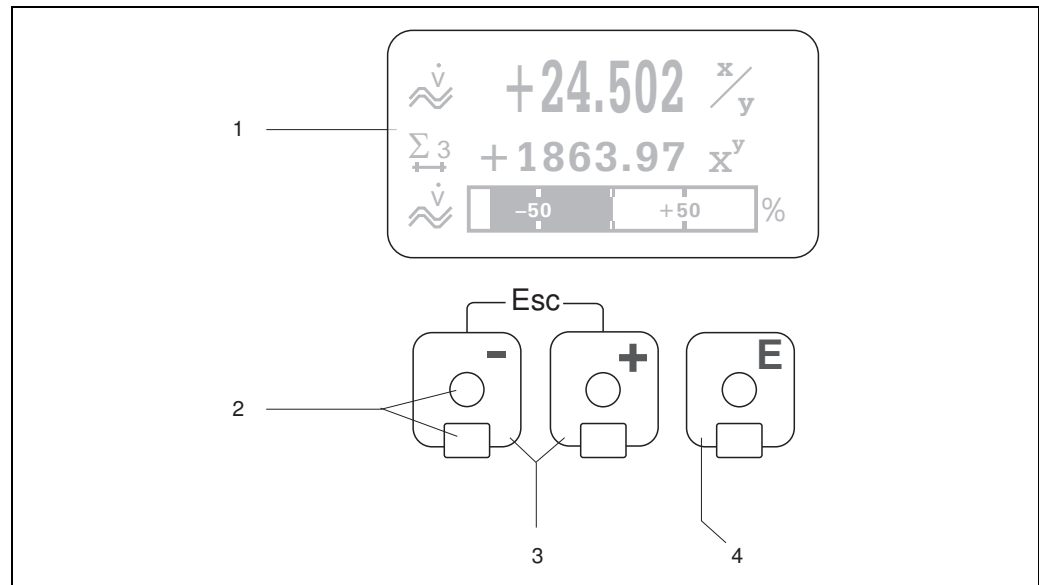

Fig. 26: Display and operating elements

- 1 **Liquid crystal display**
The backlit, four-line liquid-crystal display shows measured values, dialog texts, fault messages and notice messages. The display as it appears when normal measuring is in progress is known as the HOME position (operating mode).
Display
- 2 **Optical sensors for Touch Control**
- 3 **+/- keys**
 - HOME position → Direct access to totalizer values and actual values of inputs/outputs
 - Enter numerical values, select parameters
 - Select different blocks, groups and function groups within the function matrix

Press the +/- keys simultaneously to trigger the following functions:

 - Exit the function matrix step by step → HOME position
 - Press and hold down the +/- keys for longer than 3 seconds → Return directly to the HOME position
 - Cancel data entry
- 4 **E key**
 - HOME position → Entry into the function matrix
 - Save the numerical values you input or settings you change

5.2.2 Display (operating mode)

The display area consists of three lines in all; this is where measured values are displayed, and/or status variables (direction of flow, bar graph, etc.). You can change the assignment of display lines to different variables to suit your needs and preferences (→ See the "Description of Device Functions" manual).

Multiplex mode:

A maximum of two different display variables can be assigned to each line. Variables multiplexed in this way alternate every 10 seconds on the display.

Error messages:

Display and presentation of system/process errors → 42

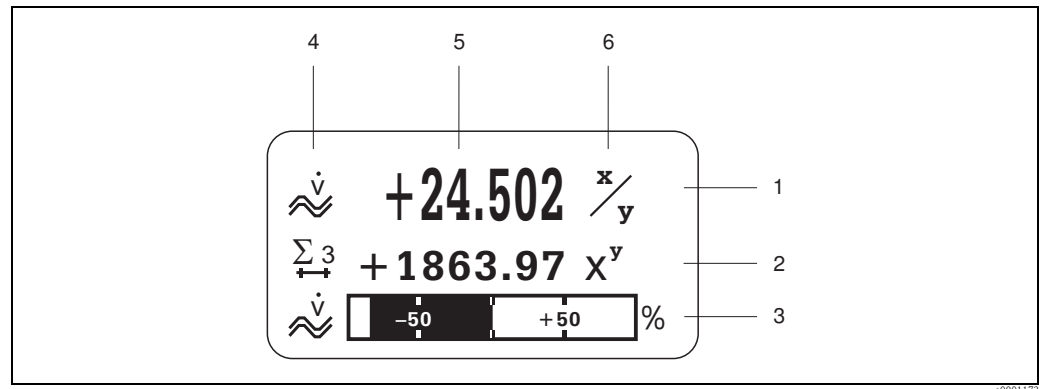

Fig. 27: Typical display for normal operating mode (HOME position)

- 1 Main line: shows main measured values
- 2 Additional line: shows additional measured variables and status variables
- 3 Information line: shows additional information on the measured variables and status variables, e.g. bar graph display
- 4 "Info icons" field: icons representing additional information on the measured values are shown in this field → 38.
- 5 "Measured values" field: the current measured values appear in this field.
- 6 "Unit of measure" field: the units of measure and time defined for the current measured values appear in this field.













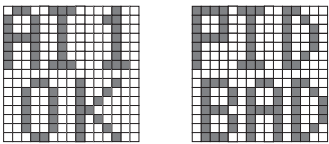

Note!









In the HOME position, you can use the / keys to call up a list containing the following information:

- Totalizer values (including overflow)
 - Tag name (DEVICE PD-TAG)
- View individual values in the list
 (Esc key) → Back to HOME position

5.2.3 Icons

The icons which appear in the field on the left make it easier to read and recognize measured variables, device status, and error messages.

Icon	Meaning	Icon	Meaning
S	System error	P	Process error
⚡	Fault message (measuring is interrupted)	!	Notice message (measuring continues despite the message)
Σ 1 to n	Totalizer 1 to n	AI 1 (to n)	Analog Input Function Block 1 (to n), output value OUT
PID	PID Function Block: A PID Function Block value as listed below is output, depending on the assignment of the lines in the local display: – OUT value (= manipulated variable) – IN value (= control variable) – CAS_IN value (= external set point)		
The messages listed below describe the status of the OUT value of the Analog Input Function Block and the value assigned to the PID Function Block.			
OK	Status = GOOD (valid)	UNC	Status = UNCERTAIN (valid to a certain extent)
BAD	Status = BAD (not valid)	Example: 	
 a0001182	Measuring mode: SYMMETRY (bidirectional)	 a0001183	Measuring mode: STANDARD
 a0001184	Counting mode, totalizer: BALANCE (forward and reverse flow)	 a0001185	Counting mode, totalizer: forward
 a0001186	Counting mode, totalizer: reverse	 a0001188	Volume flow
 a0001189	Target volume flow	 a0001193	% Target volume flow
 a0001190	Target corrected volume flow	 a0001191	Carrier volume flow
 a0001194	% Target volume flow	 a0001192	Carrier corrected volume flow

Icon	Meaning	Icon	Meaning
 a0001195	Mass flow	 a0001196	Target mass flow
 a0001197	% Target mass flow	 a0001198	Carrier mass flow
 a0001199	% Carrier mass flow	 a0001200	Fluid density
 a0001208	Reference density	 a0001207	Fluid temperature

5.3 Brief operating instructions on the function matrix



Note!

- See the general notes → 41
 - Function descriptions → See the "Description of Device Functions" manual
1. HOME position → **E** → Enter the function matrix
 2. Select a block (e.g. MEASURED VARIABLES)
 3. Select a group (e.g. SYSTEM UNITS)
 4. Select a function group (e.g. CONFIGURATION)
 5. Select a function (e.g. UNIT VOLUME FLOW)
Change parameter / enter numerical values:
 - Select or enter enable code, parameters, numerical values
 - E** → Save your entries
 6. Exit the function matrix:
 - Press and hold down Esc key () for longer than 3 seconds → HOME position
 - Repeatedly press Esc key () → Return step by step to HOME position

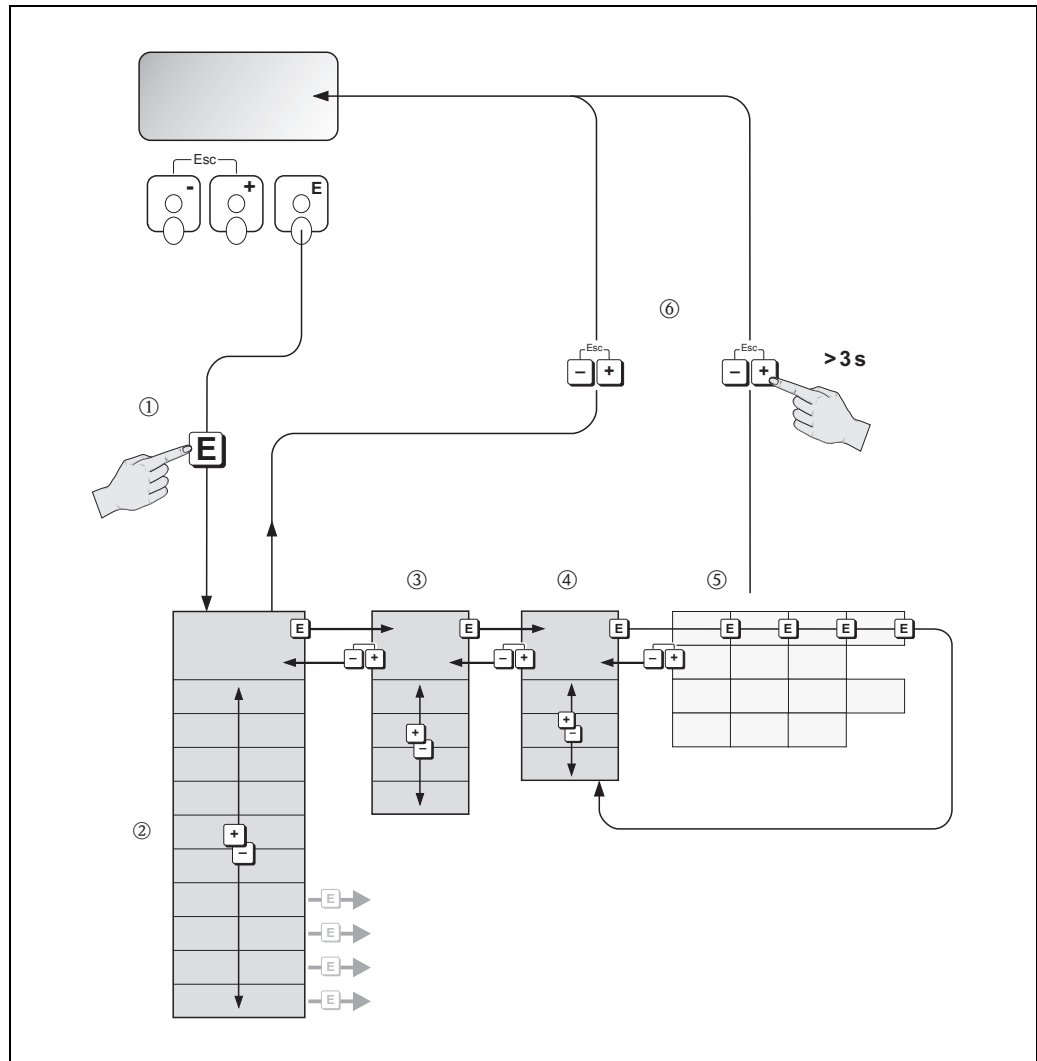



Fig. 28: Selecting functions and configuring parameters (function matrix)

5.3.1 General notes

The Quick Setup menu contains the default settings that are adequate for commissioning. Complex measuring operations on the other hand necessitate additional functions that you can configure as necessary and customize to suit your process parameters. The function matrix, therefore, comprises a multiplicity of additional functions which, for the sake of clarity, are arranged on a number of menu levels (blocks, groups, and function groups).

Comply with the following instructions when configuring functions:

- You select functions as described on →  40.
Each cell in the function matrix is identified by a numerical or letter code on the display.
- You can switch off certain functions (OFF). If you do so, related functions in other function groups will no longer be displayed.
- Certain functions prompt you to confirm your data entries. Press $\boxed{+/-}$ to select "SURE [YES]" and press \boxed{E} again to confirm. This saves your setting or starts a function, as applicable.
- Return to the HOME position is automatic if no key is pressed for 5 minutes.
- Programming mode is disabled automatically if you do not press a key within 60 seconds following automatic return to the HOME position.



Caution!

All functions are described in detail, as is the function matrix itself, in the "Description of Device Functions" manual, which is a separate part of these Operating Instructions.



Note!

- The transmitter continues to measure while data entry is in progress, i.e. the current measured values are output via the signal outputs or the fieldbus communication in the normal way.
- If the supply voltage fails all preset and parameterized values remain safely stored in the EEPROM.

5.3.2 Enabling the programming mode

The function matrix can be disabled. Disabling the function matrix rules out the possibility of inadvertent changes to device functions, numerical values or factory settings. A numerical code (factory setting = 83) has to be entered before settings can be changed.

If you use a code number of your choice, you exclude the possibility of unauthorized persons accessing data (→ See the "Description of Device Functions" manual).

Comply with the following instructions when entering codes:

- If programming is disabled and the $\boxed{+/-}$ operating elements are pressed in any function, a prompt for the code automatically appears on the display.
- If "0" is entered as the customer's code, programming is always enabled.
- The Endress+Hauser service organization can be of assistance if you mislay your personal code.



Caution!

- Changing certain parameters such as all sensor characteristics, for example, influences numerous functions of the entire measuring system, particularly measuring accuracy. There is no need to change these parameters under normal circumstances and consequently, they are protected by a special code known only to the Endress+Hauser service organization. Please contact Endress+Hauser if you have any questions.
- With FOUNDATION Fieldbus, programming is enabled separately in the Transducer Block.

5.3.3 Disabling the programming mode

Programming mode is disabled if you do not press an operating element within 60 seconds following automatic return to the HOME position.

You can also disable programming in the "ACCESS CODE" function by entering any number (other than the customer's code).

5.4 Error messages

5.4.1 Type of error

Errors that occur during commissioning or measuring are displayed immediately. If two or more system or process errors are present, the error with the highest priority is the one shown on the display.

The measuring system distinguishes between two types of error:

- System error: Includes all device errors, for example communication errors, hardware errors, etc. → 80
- Process error: Includes all application errors, e.g. fluid not homogeneous, etc. → 87

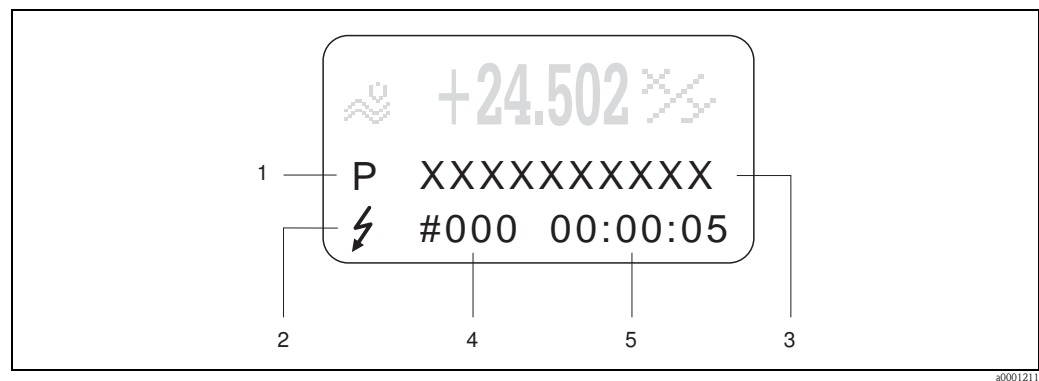

Fig. 29: Error messages on the display (example)

- 1 Error type: P = process error, S = system error
- 2 Error message type: ⚡ = fault message, ! = notice message
- 3 Error designation
- 4 Error number
- 5 Duration of most recent error occurrence (hours: minutes: seconds)

5.4.2 Error message type

The measuring device always assigns system and process errors which occur to two types of error messages (**fault** or **notice messages**), resulting in different weightings → 79.

Serious system errors, e.g. module defects, are always identified and classed as "fault messages" by the measuring device.

Notice message (!)

- The error in question has no effect on measurement currently in progress.
- Displayed as → Exclamation mark (!), type of error (S: system error, P: process error)
- Presentation on the FOUNDATION Fieldbus → Notice messages are transmitted to subsequent Function Blocks or higher-level process control systems by means of the status "UNCERTAIN" of the output value OUT (AI Block).

Fault message (⚡)

- The error in question interrupts or stops measurement currently in progress.
- Displayed as → Lightning flash (⚡), type of error (S: system error, P: process error)
- Presentation on the FOUNDATION Fieldbus → Fault messages are transmitted to subsequent Function Blocks or higher-level process control systems by means of the status "BAD" of the output value OUT (AI Block).

5.5 Operating programs

5.5.1 FieldCare

FieldCare is Endress+Hauser's FDT-based plant asset management tool and allows the configuration and diagnosis of intelligent field devices. By using status information, you also have a simple but effective tool for monitoring devices. The Proline flowmeters are accessed via a service interface or via the service interface FXA193.

5.5.2 Operating via FOUNDATION Fieldbus configuration programs

The user can obtain special configuration and operating programs offered by the different manufacturers for use in configuration. These can be used for configuring both the FOUNDATION Fieldbus functions and all the device-specific parameters. The predefined Function Blocks allow uniform access to all the network and fieldbus device data.

A step-by-step description of the procedure for commissioning the FF functions is given on →  46, along with the configuration of device-specific parameters.

General information on FOUNDATION Fieldbus is provided in the Operating Instructions "FOUNDATION Fieldbus Overview" (BA013S) acquired at: → www.endress.com → Download.

System files

You will need the following files for commissioning and network configuration:

- Commissioning → Device description (Device Description: *.sym, *.ffo)
- Network configuration → CFF file (Common File Format: *.cff)

You can obtain these files as follows:

- Free of charge via the Internet → www.endress.com
- From Endress+Hauser stating the order number (No. 56003896)
- Via the Fieldbus Foundation Organization → www.fieldbus.org



Note!

Ensure you use the correct system files for linking the field devices into the host system. Appropriate version information can be called up via the following functions/parameters:

Local display:

- HOME → BASIC FUNCTIONS → FOUND. FIELDBUS → INFORMATION → DEVICE REVISION (6243)
- HOME → BASIC FUNCTIONS → FOUND. FIELDBUS → INFORMATION → DD REVISION (6244)

FOUNDATION Fieldbus interface

- Resource Block → Parameter DEV_REV
- Resource Block → Parameter DD_REV

Example (with local display):

Display in the DEVICE REVISION (6243) function → 04

Display in the DD REVISION (6244) function → 01

Device description file (DD) required → 0401.sym / 0401.ffo

5.5.3 Device description files for operating programs

The following section illustrates the suitable device description file for the operating program in question and then indicates where this can be obtained.

Operation via FOUNDATION Fieldbus:

Valid for device software	3.00.XX	→ Function "Device software" (8100)
Device data FOUNDATION Fieldbus		
Manufacturer ID:	11 _{hex} (ENDRESS+HAUSER)	→ Function "Manufacturer ID" (6040)
Device ID:	1051 _{hex}	→ Function "Device ID" (6041)
FOUNDATION Fieldbus version data		
	Device Revision 4/DD Revision 1	
Software release		
	10.2009	
Operating program	How to acquire:	
Device Description (DD) and Capability File (CFF)	<ul style="list-style-type: none"> ■ www.endress.com → Download ■ www.fieldbus.org ■ CD-ROM (Endress+Hauser order number: 56003896) 	
Device driver for FF host systems:	How to acquire:	
ABB (FieldController 800)	www.abb.com	
Allen Bradley (Control Logix)	see FF standard device driver	
Emerson (Delta V)	www.easydeltav.com	
Endress+Hauser (ControlCare)	see FF standard device driver	
Honeywell (Experion PKS)	www.honeywell.com	
SMAR (System 302)	see FF standard device driver	
Yokogawa (CENTUM CS 3000)	www.yokogawa.com	
Device drivers for additional FF operating programs:	Sources for obtaining updates:	
Handheld terminal 375	www.fieldcommunicator.com  Note! The device drivers can be added and updated via the update function of the handheld terminal 375.	

Tester/simulator:	Sources for obtaining device descriptions:
Fieldcheck	<ul style="list-style-type: none"> ■ Update by means of FieldCare with the Flow Device FXA193/291 DTM in the Fieldflash Module



Note!

The Fieldcheck tester/simulator is used for testing flowmeters in the field. When used in conjunction with the "FieldCare" software package, test results can be imported into a database, printed and used for official certification. Contact your Endress+Hauser representative for more information.

5.6 FOUNDATION Fieldbus hardware settings

5.6.1 Switching hardware write protection on and off



A jumper on the I/O board provides the means of switching hardware write protection on or off.

Warning!

Risk of electric shock. Exposed components carry dangerous voltages. Make sure that the power supply is switched off before you remove the cover of the electronics compartment.

1. Switch off power supply.
2. Remove the I/O board → [91](#)
3. Configure hardware write protection and simulation mode appropriately using the jumpers (see graphic).
4. Installation of the I/O board is the reverse of the removal procedure.

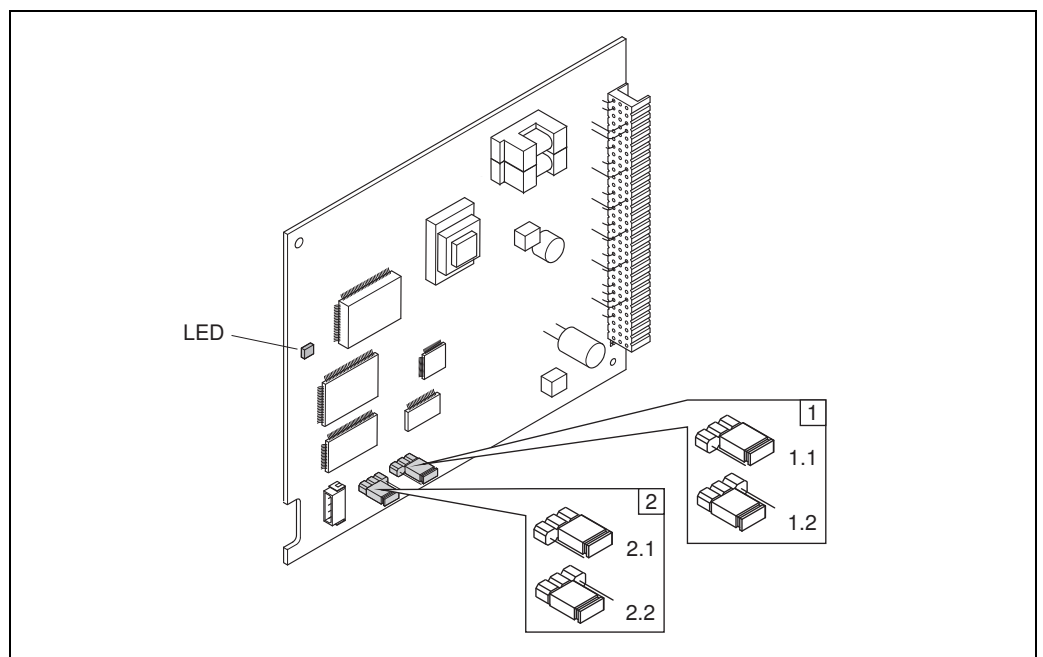

Fig. 30: Hardware configuration (I/O board)

1 Jumper for enabling/disabling write protection:

- 1.1 Write protection disabled (factory setting) = it is possible to write-access the device functions via the FF interface
- 1.2 Write protection enabled = it is **not** possible to write-access the device functions via the FF interface

2 Jumper for simulation mode:

- 2.1 Simulation mode enabled (factory setting) = simulation in the Analog Input Function Block and in the Discrete Output Function Block is possible
- 2.2 Simulation mode disabled = simulation in the Analog Input Function Block and in the Discrete Output Function Block is **not** possible

LED (light emitting diode):

- Continuously lit → Ready (no communication via FF active)
- Not lit → Not ready
- Flashes slowly → Ready (communication via FF active)
- Flashes quickly → Device error present (error message type "fault message") → [75](#)

6 Commissioning

6.1 Function check

Make sure that the following function checks have been performed successfully before switching on the supply voltage for the measuring device:

- Checklist for "Post-installation check" →  25
- Checklist for "Post-connection check" →  34

6.2 Switching on the measuring device

Once the function check has been performed successfully, the device is operational and can be switched on via the supply voltage. The device then performs internal test functions and the following messages are shown on the local display:

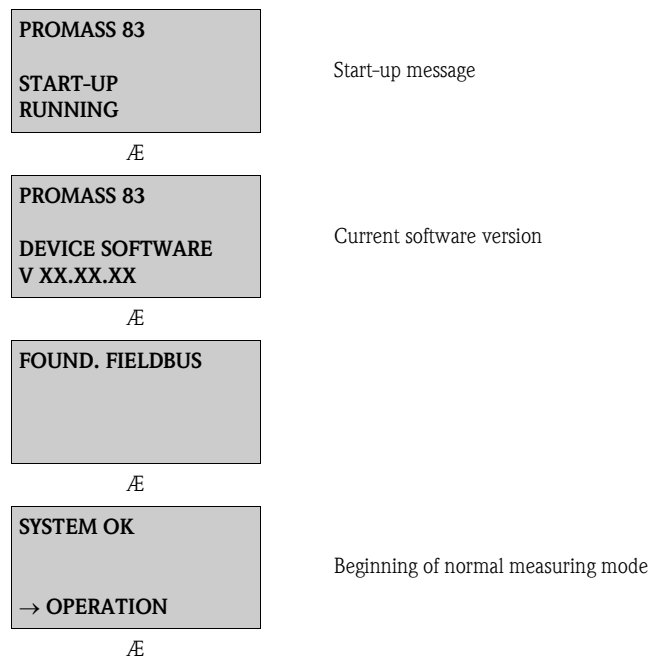

Normal measuring mode commences as soon as startup completes.
Various measured value and/or status variables appear on the display (HOME position).



Note!
If startup fails, an error message indicating the cause is displayed.

6.3 Commissioning via FOUNDATION Fieldbus

Note the following points:

- The files required for commissioning and network configuration can be obtained as described on → 43.
- The device is identified by the FOUNDATION Fieldbus in the host or configuration system via the device ID (DEVICE_ID). The DEVICE_ID is a combination of the manufacturer ID, device type and device serial number. It is unique and can never be duplicated.

The DEVICE_ID of the Promass 83 is composed as follows:

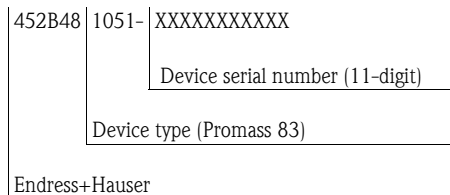

Commissioning

The following description allows step-by-step commissioning of the measuring device and all the necessary configuration for the FOUNDATION Fieldbus:

1. Switch on the measuring device.
2. Note the DEVICE_ID on the device nameplate (→ 8).
3. Open the configuration program.
4. Load the device description file or CFF file into the host system or into the configuration program. Ensure you use the correct system files. Refer to the example on → 43. The first time it is connected the measuring device reports as follows:

- EH_PROMASS_83_ xxxxxxxxxxxx (Tag name PD-TAG)
- 452B481051- xxxxxxxxxxxx (Device_ID)
- Block structure:

Display text (xxx... = serial number)	Base index	Description
RESOURCE_ xxxxxxxxxxxx	400	Resource Block
TRANSDUCER_FLOW_ xxxxxxxxxxxx	1400	"Flow" Transducer Block
TRANSDUCER_DIAG_ xxxxxxxxxxxx	1600	"Diagnosis" Transducer Block
TRANSDUCER_DISP_ xxxxxxxxxxxx	1800	"Display" Transducer Block
TRANSDUCER_TOT_ xxxxxxxxxxxx	1900	"Totalizer" Transducer Block
TRANSDUCER_CDENS_ xxxxxxxxxxxx	2000	"Calculated Density" Transducer Block
TRANSDUCER_VISC_ xxxxxxxxxxxx	2100	"Viscosity" Transducer Block
TRANSDUCER_ADVD_ xxxxxxxxxxxx	2200	"Advanced Diagnostics" Transducer Block
ANALOG_INPUT_1_ xxxxxxxxxxxx	500	Analog Input Function Block 1
ANALOG_INPUT_2_ xxxxxxxxxxxx	550	Analog Input Function Block 2
ANALOG_INPUT_3_ xxxxxxxxxxxx	600	Analog Input Function Block 3
ANALOG_INPUT_4_ xxxxxxxxxxxx	650	Analog Input Function Block 4
ANALOG_INPUT_5_ xxxxxxxxxxxx	700	Analog Input Function Block 5
ANALOG_INPUT_6_ xxxxxxxxxxxx	750	Analog Input Function Block 6
ANALOG_INPUT_7_ xxxxxxxxxxxx	800	Analog Input Function Block 7
ANALOG_INPUT_8_ xxxxxxxxxxxx	850	Analog Input Function Block 8
DISCRETE_OUTPUT_ xxxxxxxxxxxx	900	Discrete Output Function Block (DO)

Display text (xxx... = serial number)	Base index	Description
PID_XXXXXXXXXX	1000	PID Function Block (PID)
ARITHMETIC_XXXXXXXXXX	1100	Arithmetic Function Block (ARTH)
INPUT_SELECTOR_XXXXXXXXXX	1150	Input Selector Function Block (ISEL)
SIGNAL_CHARACTER_XXXXXXXXXX	1200	Signal Characterizer Function Block (CHAR)
INTEGRATOR_XXXXXXXXXX	1250	Integrator Function Block (INTG)



Note!

This measuring device is supplied with the bus address "250" and is thus in the address range reserved for readdressing field devices, between 248 and 251. This means that the LAS (Link Active Scheduler) automatically assigns the device a free bus address in the initialization phase.

- Identify the field device using the DEVICE_ID that you noted down and assign the desired field device tag name (PD_TAG) to the fieldbus device in question.
Factory setting: EH_PROMASS_83_XXXXXXXXXX

Configuration of the "Resource Block" (base index 400)

- Open the Resource Block.
- On delivery, hardware write protection is disabled so that you can access all the write parameters via FOUNDATION Fieldbus. Check this status via the parameter WRITE_LOCK:
 - Write protection activated = LOCKED
 - Write protection deactivated = NOT LOCKED

Deactivate the write protection if necessary → 45.

- Enter the desired block name (optional).
Factory setting: RESOURCE_XXXXXXXXXX
- Set the operating mode in the parameter group MODE_BLK (parameter TARGET) to AUTO.

Configuration of the "Transducer Blocks"

The individual Transducer Blocks comprise various parameter groups ordered by device-specific functions:

Transducer Block	Base index	Description
"Flow" Transducer Block	1400	Flow measurement
"Diagnosis" Transducer Block	1600	Diagnostic functions
"Display" Transducer Block	1800	Local display functions
"Totalizer" Transducer Block	1900	Totalizer 1 to 3
"Calculated Density" Transducer Block	2000	Density functions
"Viscosity" Transducer Block	2100	Viscosity measurement
"Advanced Diagnostics" Transducer Block	2200	Advanced diagnostic functions

The following description provides an example for the "Flow" Transducer Block (base index: 1400).

- Enter the desired block name (optional).
Factory setting: TRANSDUCER_FLOW_XXXXXXXXXX
- Open the "Flow" Transducer Block.
- Now configure the device-specific parameters relevant for your application:

 Note!

- Note that changes to the device parameters can only be made after entering a valid access code in the parameter "Access – Code".
 - The selection of the system units in the "Flow" Transducer Block has no effect on the output value OUT (AI Block). Units of the process variables which are transmitted via the FOUNDATION Fieldbus interface must be specified separately in the Analog Input Function Block via the XD_SCALE and OUT_SCALE parameter group.
13. Set the "Flow" and "Totalizer" Transducer Blocks to AUTO in the MODE_BLK parameter group (TARGET parameter). Only then is it ensured that the process variables can be processed correctly by the downstream AI Function Block.

Configuration of the "Analog Input Function Blocks"

The measuring device has seven Analog Input Function Blocks that can be assigned to the various process variables. The following description provides an example for the Analog Input Function Block 1 (base index: 500).

14. Enter the desired name for the Analog Input Function Block (optional).
Factory setting: ANALOG_INPUT_1xxxxxxxxxxx
15. Open the Analog Input Function Block 1.
16. Set the operating mode in the parameter group MODE_BLK (parameter TARGET) to OOS, i.e. block Out Of Service.
17. Using the parameter CHANNEL select the process variable that is to be used as the input value for the Function Block algorithm (scaling and limit value monitoring functions). The following configurations are possible:

Process variable	Channel parameter
Mass flow	1
Volume flow	2
Corrected volume flow	3
Density	4
Reference density	5
Temperature	6
Totalizer 1	7
Totalizer 2	8
Totalizer 3	9
The following process variables are available if the "Concentration measurement" add-on is installed in the measuring device (order option)	
Target fluid mass flow	40
Target fluid % mass	41
Target fluid volume flow	42
Target fluid % volume	43
Target fluid corrected volume flow	44
Carrier fluid mass flow	45
Carrier fluid % mass	46
Carrier fluid volume flow	47
Carrier fluid % volume	48
Carrier fluid corrected volume flow	49
% Black liquor	41

Process variable	Channel parameter
°Baume	50
°API	
°Plato	
°Balling	
°Brix	
Flexible	
The following process variables are available if the "Viscosity" add-on is installed in the measuring device (order option)	
Dynamic viscosity	90
Kinematic viscosity	91
Temperature-compensated dynamic viscosity	92
Temperature-compensated kinematic viscosity	93
The following process variables are available if the "Advanced diagnostics" add-on is installed in the measuring device (order option)	
Mass flow deviation	70
Density deviation	71
Reference density deviation	72
Temperature deviation	73
Tube damping deviation	74
Electrodynamic sensor deviation	75
Deviation of operating frequency fluctuation	76
Deviation of tube damping fluctuation	77

18. In the parameter group XD_SCALE, select the desired engineering unit and the block input range (measurement range of the flow application) for the process variable in question (see following example).

 **Caution!**

Make sure that the selected unit is suitable for the measurement variable of the selected process variable. Otherwise the parameter BLOCK_ERROR will display the error message "Block Configuration Error" and the block operating mode cannot be set to AUTO.

19. In the L_TYPE parameter, select the mode of linearization for the input variable (Direct, Indirect, Indirect Sq Root) → See the "Description of Device Functions" manual.

 **Caution!**

Note that with the type of linearization "Direct" the configuration of the parameter group OUT_SCALE must agree with the configuration of the parameter group XD_SCALE. Otherwise the block operating mode cannot be set to AUTO. Such incorrect configuration is indicated via the parameter BLOCK_ERROR with the "Block Configuration Error" message.

Example:

- The measurement range of the sensor is 0 to 30 kg/h.
- The output range to the process control system should be 0 to 30 kg/h as well.

The following settings should be made:

- Analog Input Function Block / parameter CHANNEL (selection of input value),
selection: 1 → Mass flow
- Parameter L_TYPE → Direct
- Parameter group XD_SCALE
XD_SCALE 0% = 0
XD_SCALE 100% = 30
XD_SCALE UNIT = kg/h
- Parameter group OUT_SCALE
OUT_SCALE 0% = 0
OUT_SCALE 100% = 30
OUT_SCALE UNIT = kg/h

20. Use the following parameters to define the limit values for alarm and warning messages:
 - HI_HI_LIM → Limit value for the upper alarm
 - HI_LIM → Limit value for the upper warning
 - LO_LIM → Limit value for the lower warning
 - LO_LO_LIM → Limit value for the lower alarm
 The limit values entered must be within the value range specified in the parameter group OUT_SCALE.
21. In addition to the actual limit values you must also specify the action taken if a limit value is exceeded using so-called "alarm priorities" (parameters HI_HI_PRI, HI_PRI, LO_PR, LO_LO_PRI) → See the "Description of Device Functions" manual. Reporting to the fieldbus host system only takes place if the alarm priority is higher than 2.
22. System configuration/connection of Function Blocks:
A concluding "overall system configuration" is essential so that the operating mode of the Analog Input Function Block can be set to AUTO and so that the field device is integrated into the system application. To do this, configuration software is used to connect the Function Blocks to the desired control strategy - generally graphically - and then the sequence of the individual process control functions is specified.
23. After specifying the active LAS, download all the data and parameters into the field device.
24. Set the operating mode in the parameter group MODE_BLK (parameter TARGET) to AUTO. This is only possible under two conditions, however:
 - The Function Blocks are correctly connected with each other.
 - The Resource Block is in operating mode AUTO.

Configuration of the "Analog Output Function Block" (base index 2300)

The measuring device has one Analog Output Function Block that can be assigned to the various process variables.

The following example illustrates how the value for the operating density ("System Value - Fixed Density" parameter can be read in via the Analog Output Function Block of a density measuring device (e.g. Gammapilot M). The connection first has to be established between the Analog Output Function Block and the "System Value - Fixed Density" parameter in the "Flow" Transducer Block. For this purpose, the value "4" (density) must be assigned to the CHANNEL parameter.

25. Enter the desired name for the Analog Output Function Block (optional). Factory setting:
ANALOG_OUTPUT_XXXXXXXXXX
26. Open the Analog Output Function Block.
27. Set the operating mode in the parameter group MODE_BLK (parameter TARGET) to OOS, i.e. block Out Of Service.
28. Using the parameter CHANNEL select "density", which is to be used as the input value for the Transducer Block algorithm (scaling function). The following configurations are possible:

Process variable	Channel parameter
Density	4

29. In the parameter group PV_SCALE, select the desired engineering unit and the block input range (measurement range of the density application) for the process variable in question (see following example).



Caution!

Make sure that the selected unit is suitable for the measurement variable of the selected process variable. Otherwise the parameter BLOCK_ERROR will display the error message "Block Configuration Error" and the block operating mode cannot be set to AUTO.

Example:

- The measurement range of the density application is 0 to 30 kg/l.
- The output range to the process control system should be 0 to 30 kg/l as well.
- The following settings must be made:
 - Analog Output Function Block / parameter CHANNEL (selection of output value), selection 4 = density
 - Parameter SHED_OPTIONS → e.g. Normal Shed Normal Return
 - Parameter group PV_SCALE
 - PV_SCALE 0% = 0
 - PV_SCALE 100% = 30
 - PV_SCALE UNIT = kg/l
 - Parameter group OUT_SCALE
 - OUT_SCALE 0% = 0
 - OUT_SCALE 100% = 30
 - OUT_SCALE UNIT = kg/l

30. Set the operating mode in the parameter group MODE_BLK (parameter TARGET) to AUTO.
31. System configuration/connection of Function Blocks:
A concluding "overall system configuration" is essential so that the operating mode of the Analog Output Function Block can be set to AUTO and so that the device is integrated into the system application. To do this, configuration software is used to connect the Function Blocks to the desired control strategy - generally graphically - and then the sequence of the individual process control functions is specified.

6.4 Quick Setup

In the case of measuring devices without a local display, the individual parameters and functions must be configured via the operating program, e.g. FieldCare.

If the measuring device is equipped with a local display, all the important device parameters for standard operation, as well as additional functions, can be configured quickly and easily by means of the following Quick Setup menus.

6.4.1 Quick Setup "Commissioning"

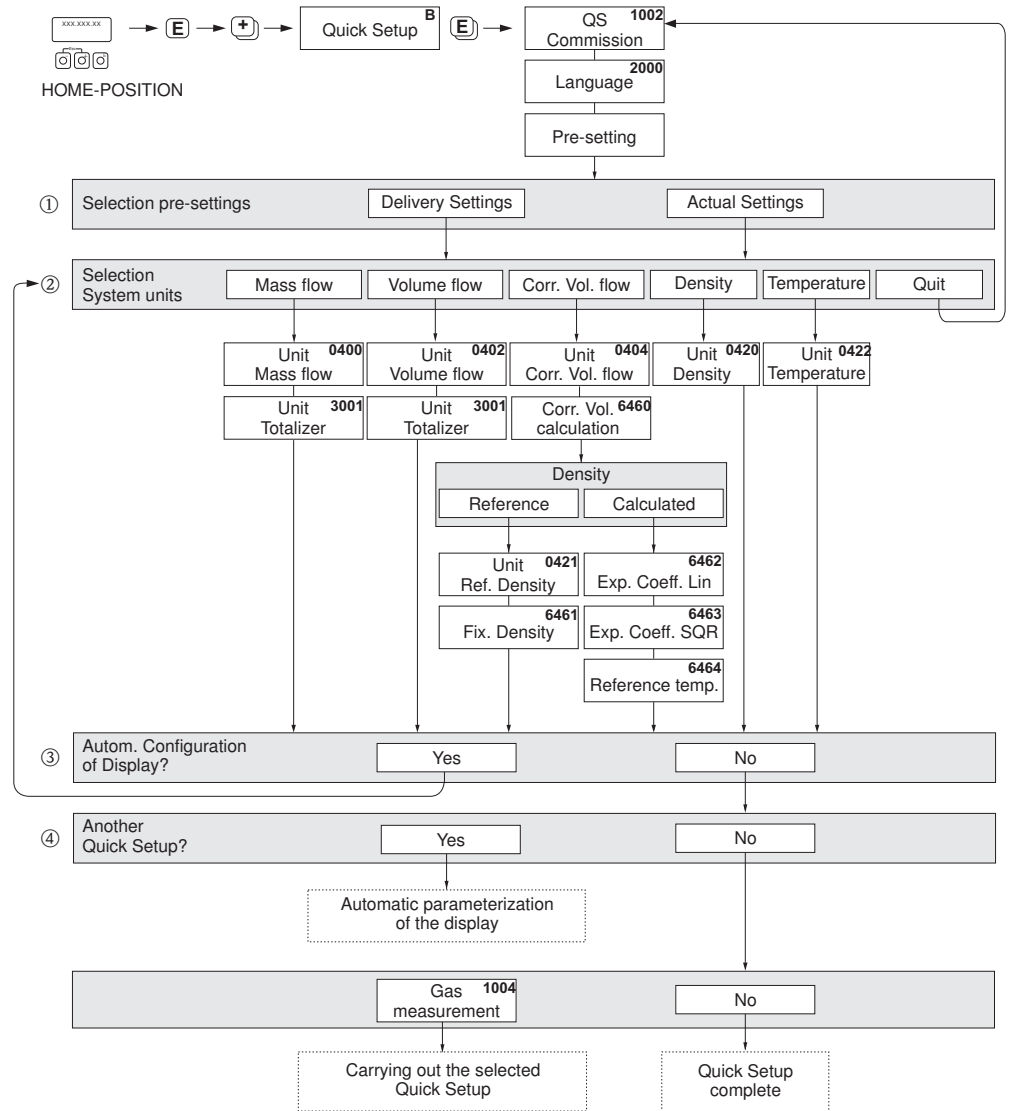

Fig. 31: Quick Setup "Commissioning" (only with local display)

a0004740-en



Note!

- The display returns to the cell SETUP COMMISSIONING (1002) if you press the key combination during parameter interrogation. The stored parameters remain valid.
- The system units selected via the Quick Setup are only valid for the local display and for parameters in the Transducer Blocks. They have no effect on the process variables which are transmitted via the FOUNDATION Fieldbus.

- ① The DELIVERY SETTINGS option sets every selected unit to the factory setting. The ACTUAL SETTINGS option accepts the units you previously configured.
- ② Only units not yet configured in the current Setup are offered for selection in each cycle. The unit for mass, volume and corrected volume is derived from the corresponding flow unit.
- ③ The YES option remains visible until all the units have been configured. NO is the only option displayed when no further units are available.
- ④ The "automatic parameterization of the display" option contains the following basic settings/factory settings:

YES	Main line = Mass flow
	Additional line = Totalizer 1
	Information line = Operating/system conditions
NO	The existing (selected) settings remain.

6.4.2 Quick Setup "Gas Measurement"

The measuring device is not only suitable for measuring liquid flow. Direct mass measurement based on the Coriolis principle is also possible for measuring the flow rate of gases.



Note!

- Before carrying out the Quick Setup "Gas measurement" the Quick Setup "Commissioning" has to be executed → 53.
- Only mass and Corrected volume flow can be measured and output with the gas measurement mode. Note that direct density and/or volume measurement is not possible!
- The flow ranges and measuring accuracy that apply to gas measurement are not the same as those for liquids.
- If corrected volume flow (e.g. in Nm³/h) is to be measured and output instead of the mass flow (e.g. in kg/h), change the setting for the CORRECTED VOLUME CALCULATION function to "FIXED REFERENCE DENSITY" in the "Commissioning" Quick Setup menu.

Performing the "Gas Measurement" Quick Setup

The "Gas Measurement" Quick Setup menu guides the user systematically through all the device functions that have to be configured for measuring operations with gas.

The "Gas Measurement" Quick Setup menu can be called up in the function matrix via two separate functions:

- Via the OS GAS MEASUREMENT (1004) function → 32 or
- Via the OS COMMISSIONING (1002) function → 31

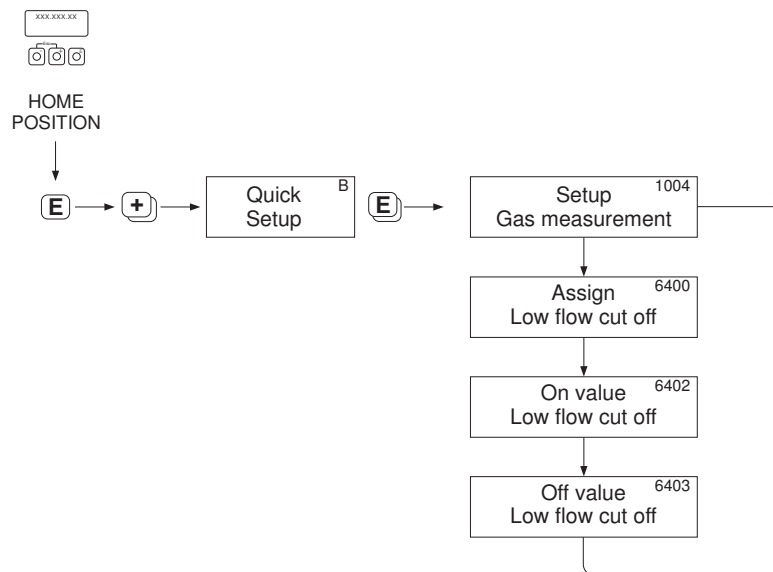

Fig. 32: Quick Setup "Gas Measurement"

Recommended settings are found on the following page.

a0002618-en

Recommended settings:

Quick Setup "Gas Measurement"		
HOME position → → MEASURED VARIABLE (A) MEASURED VARIABLE → → QUICK SETUP (B) QUICK SETUP → → OS GAS MEASUREMENT (1004)		
Function No.	Function name	Setting to be selected (/) (to next function with)
1004	OS GAS MEASUREMENT	YES Once you confirm by pressing , the Quick Setup menu calls up all the subsequent functions in succession.
▼		
6400	ASSIGN LOW FLOW CUTOFF	On account of the low mass flow involved when gas flows are measured, it is advisable not to use low flow cut off. Setting: OFF
6402	ON-VALUE LOW FLOW CUT OFF	If the ASSIGN LF CUTOFF function was not set to "OFF", the following applies: Setting: 0.0000 [unit] User input: Flow rates for gas measurements are low, so the value for the switch-on point (= low flow cut off) must be correspondingly low.
6403	OFF-VALUE LOW FLOW CUT OFF	If the ASSIGN LF CUTOFF function was not set to "OFF", the following applies: Default value: 50% User input: Enter the switch-off point as a positive hysteresis in %, referenced to the switch-on point.
▼		
Back to the HOME position: → Press and hold down Esc key for longer than three seconds or → Repeatedly press and release Esc key → Exit the function matrix step by step		



Note!

Quick Setup automatically deactivates the function EMPTY PIPE DETECTION (6420) so that the instrument can measure flow at low gas pressures.

Corrected volume measurement with gas:

Proceed as follows if the corrected volume flow (e.g. in Nm³/h) should be displayed and output instead of the mass flow (e.g. in kg/h).

1. Select the "Commissioning" Quick Setup menu via the function matrix (→ 53).
2. Under "Pre-settings", select the "Corrected volume flow" system unit and configure the functions as follows:

Function No.	Function name	Setting to be selected () (go to the next function with)
0404	UNIT CORR. VOL. FLOW	Select the engineering unit required
6460	CORR. VOL. CALCUL.	FIXED REFERENCE DENSITY
0421	UNIT REF. DENSITY	Select the engineering unit required
6461	FIXED REFERENCE DENSITY	Enter the gas-dependent reference density, (i.e. the density based on the reference temperature and reference pressure). Example for air: Reference density = 1.2928 kg/Nm ³ (based on 0 °C and 1.013 bar)

3. Exit the "Commissioning" Quick Setup menu and return to the HOME position.

6.4.3 Data backup/transmission

Using the T-DAT SAVE/LOAD function, you can transfer data (device parameters and settings) between the T-DAT (exchangeable memory) and the EEPROM (device storage unit).

This is required in the following instances:

- Creating a backup: current data are transferred from an EEPROM to the T-DAT.
- Replacing a transmitter: current data are copied from an EEPROM to the T-DAT and then transferred to the EEPROM of the new transmitter.
- Duplicating data: current data are copied from an EEPROM to the T-DAT and then transferred to EEPROMs of identical measuring points.



Note!

For information on installing and removing the T-DAT → [91](#)

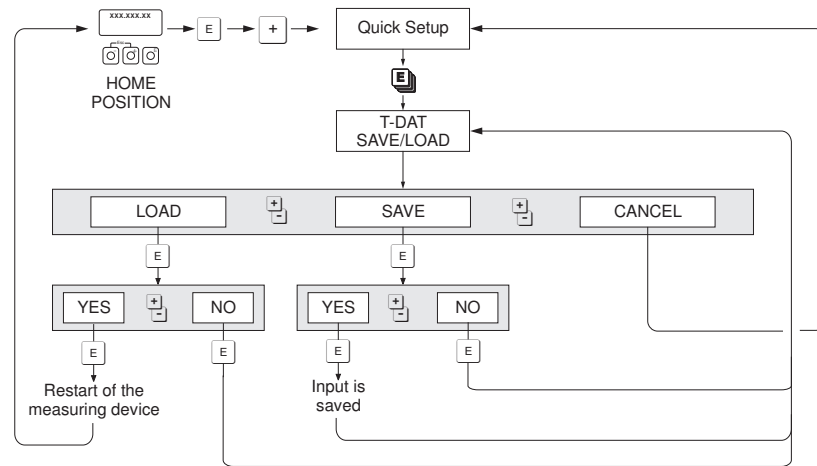

a0001221-en

Fig. 33: Data backup/transmission with the T-DAT SAVE/LOAD function

Information on the LOAD and SAVE options available:

LOAD: Data are transferred from the T-DAT to the EEPROM.



Note!

- Any settings already saved on the EEPROM are deleted.
- This option is only available if the T-DAT contains valid data.
- This option can only be executed if the software version of the T-DAT is the same as, or more recent than, that of the EEPROM. If this is not the case, the error message "TRANSM. SW-DAT" appears after restarting and the LOAD function is then no longer available.

SAVE:

Data are transferred from the EEPROM to the T-DAT.

6.5 Device configuration

6.5.1 Concentration measurement

The measuring device determines three primary variables simultaneously:

- Mass flow
- Fluid density
- Fluid temperature

As standard, these measured variables allow other process variables to be calculated, such as volume flow, reference density (density at reference temperature) and corrected volume flow.

The optional software package "Concentration measurement" (F-Chip, accessories) offers a multitude of additional density functions. Additional evaluation methods are available in this way, especially for special density calculations in all types of applications: → [73](#)

- Calculating percentage contents, mass and volume flow in two-phase media (carrier fluid and target fluid),
- Converting density of the fluid into special density units (°Brix, °Baumé, °API, etc.).

Concentration measurement with fixed calculation function

By means of the "DENSITY FUNCTION (7000)" function, you can select various density functions which use a fixed specified calculation mode for calculating the concentration:

Density function	Remarks
%-MASS %-VOLUME	<p>By using the functions for two-phase-media, it is possible to calculate the percentage mass or volume contents of the carrier fluid or the target fluid. The basic equations (without temperature compensation) are:</p> $\text{Mass [\%]} = \frac{D2 \cdot (\rho - D1)}{\rho \cdot (D2 - D1)} \cdot 100\%$ $\text{Volume [\%]} = \frac{(\rho - D1)}{(D2 - D1)} \cdot 100\%$ <p>D1 = density of carrier fluid (transporting liquid, e.g. water) D2 = density of target fluid (material transported, e.g. lime powder or a second liquefied material to be measured) ρ = measured overall density</p>
°BRIX	<p>Density unit used for the Food & Beverage industry which deals with the saccharose content of aqueous solutions, e.g. for measuring solutions containing sugar such as fruit juice, etc. The following ICUMSA table for Brix units is the basis for calculations within the device.</p>
°BAUME	<p>This density unit or scale is mainly used for acidic solutions, e.g. ferric chloride solutions.</p> <p>Two Baumé scales are used in practice:</p> <ul style="list-style-type: none"> – BAUME > 1 kg/l: for solutions heavier than water – BAUME < 1 kg/l : for solutions lighter than water
°BALLING °PLATO	<p>Both units are a commonly used basis for calculating the fluid density in the brewery industry. A liquid with a value of 1° BALLING (Plato) has the same fluid density as a water/cane sugar solution consisting of 1 kg cane sugar dissolved in 99 kg of water. 1° Balling (Plato) is thus 1% of the liquid weight.</p>
%-BLACK LIQUOR	<p>The units of concentration used in the paper industry for black liquor in % by mass. The formula used for the calculation is the same as for %-MASS.</p>
°API	<p>°API (= American Petroleum Institute) Density units specifically used in North America for liquefied oil products.</p>

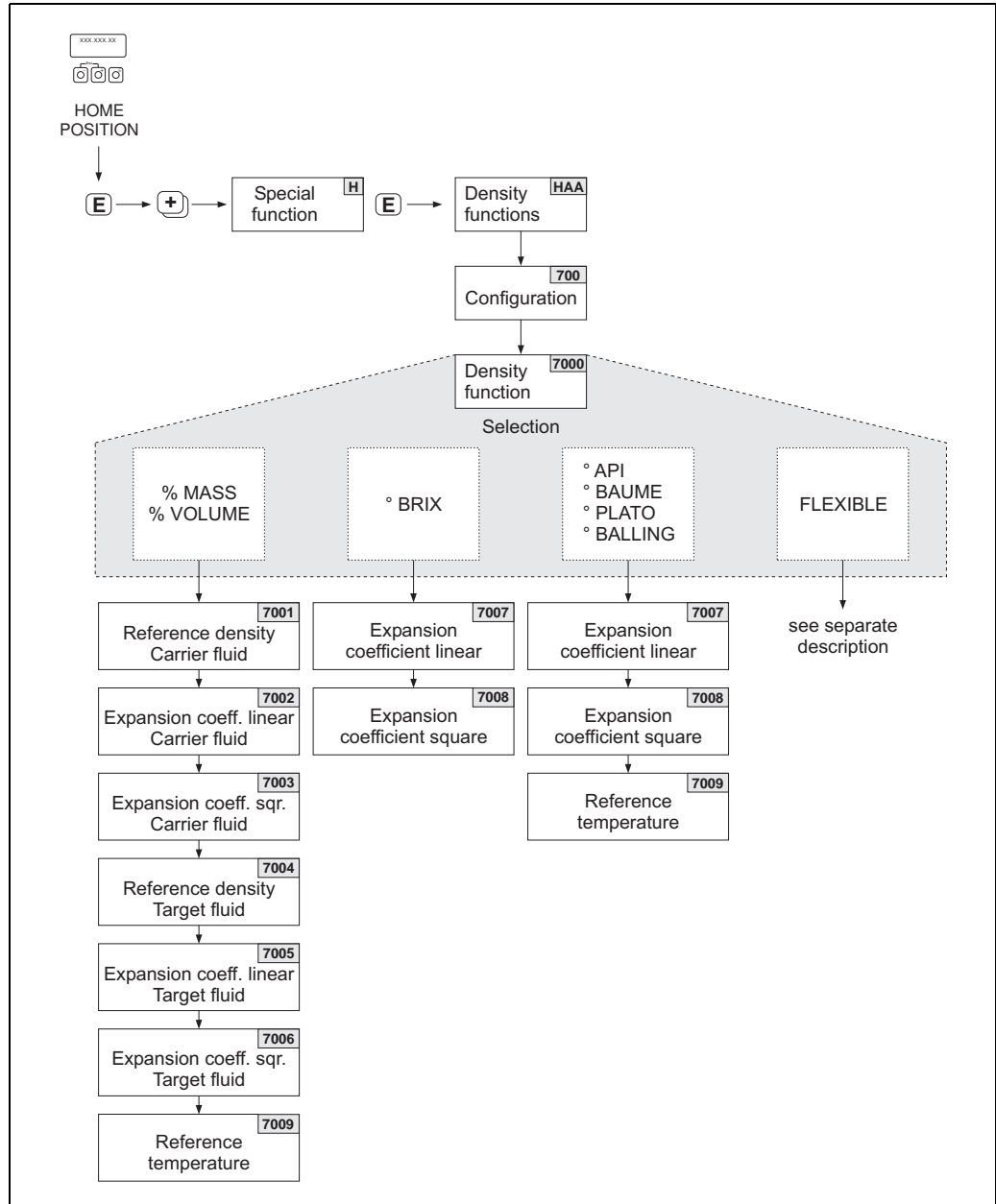

Fig. 34: Selecting and configuring different density functions in the function matrix

Brixgrade (density of hydrous saccharose solution in kg/m ³)								
°Brix	10°C	20°C	30°C	40°C	50°C	60°C	70°C	80°C
0	999.70	998.20	995.64	992.21	988.03	983.19	977.76	971.78
5	1019.56	1017.79	1015.03	1011.44	1007.14	1002.20	996.70	989.65
10	1040.15	1038.10	1035.13	1031.38	1026.96	1021.93	1016.34	1010.23
15	1061.48	1059.15	1055.97	1052.08	1047.51	1042.39	1036.72	1030.55
20	1083.58	1080.97	1077.58	1073.50	1068.83	1063.60	1057.85	1051.63
25	1106.47	1103.59	1099.98	1095.74	1090.94	1085.61	1079.78	1073.50
30	1130.19	1127.03	1123.20	1118.80	1113.86	1108.44	1102.54	1096.21
35	1154.76	1151.33	1147.58	1142.71	1137.65	1132.13	1126.16	1119.79
40	1180.22	1176.51	1172.25	1167.52	1162.33	1156.71	1150.68	1144.27
45	1206.58	1202.61	1198.15	1193.25	1187.94	1182.23	1176.14	1169.70

Brixgrade (density of hydrous saccharose solution in kg/m ³)								
°Brix	10°C	20°C	30°C	40°C	50°C	60°C	70°C	80°C
50	1233.87	1229.64	1224.98	1219.93	1214.50	1208.70	1202.56	1196.11
55	1262.11	1257.64	1252.79	1247.59	1242.05	1236.18	1229.98	1223.53
60	1291.31	1286.61	1281.59	1276.25	1270.61	1264.67	1258.45	1251.88
65	1321.46	1316.56	1311.38	1305.93	1300.21	1294.21	1287.96	1281.52
70	1352.55	1347.49	1342.18	1336.63	1330.84	1324.80	1318.55	1312.13
75	1384.58	1379.38	1373.88	1368.36	1362.52	1356.46	1350.21	1343.83
80	1417.50	1412.20	1406.70	1401.10	1395.20	1389.20	1383.00	1376.60
85	1451.30	1445.90	1440.80	1434.80	1429.00	1422.90	1416.80	1410.50

Source: A. & L. Emmerich, Technical University of Brunswick; officially recommended by ICUMSA, 20th session 1990

Concentration measurement with flexible calculation function

Under certain application conditions, it may not be possible to use density functions with a fixed calculation function (% mass, °Brix, etc.). However, user-specific or application-specific concentration calculations can be used with the "FLEXIBLE" setting in the function "DENSITY FUNCTION (7000)".

The following types of calculation can be selected in the function "MODE (7021)":

- % MASS 3D
- % VOLUME 3D
- % MASS 2D
- % VOLUME 2D

Calculation type "% MASS 3D" or "% VOLUME 3D"

For this type of calculation, the relationship between the three variables – concentration, density and temperature must be known (3-dimensional), e.g. by a table. In this way, the concentration can be calculated from the measured density and temperature values by means of the following formula (the coefficients A0, A1, etc. have to be determined by the user):

$$K = A0 + A1 \cdot \rho + A2 \cdot \rho^2 + A3 \cdot \rho^3 + A4 \cdot \rho^4 + B1 \cdot T + B2 \cdot T^2 + B3 \cdot T^3$$

a0004620

<i>K</i>	<i>Concentration</i>
<i>ρ</i>	<i>Currently measured density</i>
<i>A0</i>	<i>Value from function (COEFFICIENT A0 (7032))</i>
<i>A1</i>	<i>Value from function (COEFFICIENT A1 (7033))</i>
<i>A2</i>	<i>Value from function (COEFFICIENT A2 (7034))</i>
<i>A3</i>	<i>Value from function (COEFFICIENT A3 (7035))</i>
<i>A4</i>	<i>Value from function (COEFFICIENT A4 (7036))</i>
<i>B1</i>	<i>Value from function (COEFFICIENT B1 (7037))</i>
<i>B2</i>	<i>Value from function (COEFFICIENT B2 (7038))</i>
<i>B3</i>	<i>Value from function (COEFFICIENT B3 (7039))</i>
<i>T</i>	<i>Currently measured temperature in °C</i>

Example:

The following is a concentration table from a reference source.

Temperature	10°C	15°C	20°C	25°C	30°C
Density					
825 kg/m ³	93.6%	92.5%	91.2%	90.0%	88.7%
840 kg/m ³	89.3%	88.0%	86.6%	85.2%	83.8%
855 kg/m ³	84.4%	83.0%	81.5%	80.0%	78.5%
870 kg/m ³	79.1%	77.6%	76.1%	74.5%	72.9%
885 kg/m ³	73.4%	71.8%	70.2%	68.6%	66.9%
900 kg/m ³	67.3%	65.7%	64.0%	62.3%	60.5%
915 kg/m ³	60.8%	59.1%	57.3%	55.5%	53.7%



Note!

To determine the coefficients for calculating the concentration for the measuring device, the unit of density and the unit of temperature have to be kg/l and °C respectively, and the concentration must be entered in decimal format (e.g. 0.5 instead of 50%). The coefficients B1, B2 and B3 must be entered in scientific notation into the matrix positions 7037, 7038 and 7039 as a product with 10⁻³, 10⁻⁶ or 10⁻⁹

Assume:

Density (ρ): 870 kg/m³ → 0.870 kg/l

Temperature (T): 20°C

Coefficients determined for table above:

$$A0 = -2.6057$$

$$A1 = 11.642$$

$$A2 = -8.8571$$

$$A3 = 0$$

$$A4 = 0$$

$$B1 = -2.7747 \cdot 10^{-3}$$

$$B2 = -7.3469 \cdot 10^{-6}$$

$$B3 = 0$$

Calculation:

$$K = A0 + A1 \cdot \rho + A2 \cdot \rho^2 + A3 \cdot \rho^3 + A4 \cdot \rho^4 + B1 \cdot T + B2 \cdot T^2 + B3 \cdot T^3$$

$$= -2.6057 + 11.642 \cdot 0.870 + (-8.8571) \cdot 0.870^2 + 0 \cdot 0.870^3 + 0 \cdot 0.870^4 + (-2.7747) \cdot 10^{-3} \cdot 20 + (-7.3469) \cdot 10^{-6} \cdot 20^2 + 0 \cdot 20^3$$

$$= 0.7604$$

$$= \mathbf{76.04\%}$$

#0004620

Calculation type "% MASS 2D" or "% VOLUME 2D"

For this type of calculation, the relationship between the two variables concentration and reference density must be known (2-dimensional), e.g. by a table. In this way, the concentration can be calculated from the measured density and temperature values by means of the following formula (the coefficients A0, A1, etc. have to be determined by the user):

$$K = A0 + A1 \cdot \rho_{ref} + A2 \cdot \rho_{ref}^2 + A3 \cdot \rho_{ref}^3 + A4 \cdot \rho_{ref}^4$$

a0004621

<i>K</i>	<i>Concentration</i>
<i>ρ_{ref}</i>	<i>Currently measured reference density</i>
<i>A0</i>	<i>Value from function (COEFFICIENT A0 (7032))</i>
<i>A1</i>	<i>Value from function (COEFFICIENT A1 (7033))</i>
<i>A2</i>	<i>Value from function (COEFFICIENT A2 (7034))</i>
<i>A3</i>	<i>Value from function (COEFFICIENT A3 (7035))</i>
<i>A4</i>	<i>Value from function (COEFFICIENT A4 (7036))</i>

**Note!**

The measuring device determines the reference density by means of the density and temperature currently measured. To do so, both the reference temperature (function REFERENCE TEMPERATURE) and the expansion coefficients (function EXPANSION COEFF) must be entered in the measuring system.

The parameters important for measuring the reference density can also be entered directly via the "Commissioning" Quick Setup menu.

6.5.2 Advanced diagnostic functions

Changes to the measuring system, e.g. due to coating buildup or corrosion and abrasion on the measuring tubes, can be detected at an early stage by means of the optional software package "Advanced Diagnostics" (F-Chip, accessories →  73). Normally, these influences reduce the measuring accuracy of the system or may lead to serious system errors.

By means of the diagnostic functions it is now possible to record various process and device parameters during operation, e.g. mass flow, density/reference density, temperature values, measuring tube damping etc.

By analyzing the trend of these measured values, deviations of the measuring system from a "reference status" can be detected in good time and corrective measures can be taken.

Reference values as the basis for trend analysis

Reference values of the parameters in question must always be recorded for trend analysis. These reference values are determined under reproducible, constant conditions. Such reference values are initially recorded during calibration at the factory and saved in the measuring device.

Reference data can also be ascertained under customer-specific process conditions, e.g. during commissioning or at certain process stages (cleaning cycles, etc.).

Reference values are recorded and saved in the measuring system always by means of the device function REFERENCE CONDITION USER (7401).



Caution!

It is not possible to analyze the trend of process/device parameters without reference values! Reference values can only be determined under constant, non-changing process conditions.

Methods of ascertaining data

Process and device parameters can be recorded in two different ways which you can define in the function ACQUISITION MODE (7410):

- PERIODICAL option: Measuring device acquires data periodically. Enter the desired time interval by means of the function ACQUISITION PERIOD (7411).
- SINGLE SHOT option: The user himself acquires the data manually at different, free selectable periods.

Ensure that the process conditions always correspond to the reference status when data is being recorded. It is only in this way that deviations from the reference status can be clearly determined.



Note!

The last ten entries are retained in chronological order in the measuring system.

The "history" of such values can be called up via various functions:

Diagnosis parameters	Data saved (per parameter)
Mass flow	Reference value → "REFERENCE VALUE" function
Density	Lowest measured value → "MINIMUM VALUE" function
Reference density	Highest measured value → "MAXIMUM VALUE" function
Temperature	List of the last ten measured values → "HISTORY" function
Measuring tube damping	Deviation measured/reference value → "ACTUAL DEVIATION" function
Sensor symmetry	
Operating frequency	
fluctuation	
Tube damping fluctuation	
More detailed information can be found in the "Description of Device Functions" manual.	

Triggering warning messages

If required, a limit value can be assigned to all the process/device parameters relevant to the diagnostic functions. A warning message is triggered if this limit value is exceeded → function WARNING MODE (7403).

The limit value is entered into the measuring system as an absolute (+/-) or relative deviation from the reference value → function WARNING LEVEL (74...).

Deviations arising and recorded by the measuring system can also be output via the current or relay outputs or the fieldbus.

Data interpretation

The way the data recorded by the measuring system is interpreted depends largely on the application in question. This means that users must have a very good knowledge of their specific process conditions and the related deviation tolerances in the process, which have to be determined by the users themselves in each individual case.

For example, when using the limit function it is especially important to know the minimum and maximum deviation tolerances allowed. Otherwise there is the danger that a warning message is triggered inadvertently during "normal" process fluctuations.

There can be various reasons for deviating from the reference status. The following table provides examples and pointers for each of the six diagnosis parameters recorded:

Diagnosis parameters	Possible reasons for deviation
Mass flow	A deviation from the reference status indicates possible zero point shift.
Density	A deviation from the reference status can be caused by a change in the measuring tube resonance frequency, e.g. from deposits in the measuring tube, corrosion or abrasion.
Reference density	The reference density values can be interpreted in the same way as the density values. If the fluid temperature cannot be kept completely constant, you can analyze the reference density (density at a constant temperature, e.g. at 20 °C) instead of the density. Ensure that the parameters required for calculating the reference density have been correctly configured (functions REFERENCE TEMPERATURE and EXPANSION COEFF.).
Temperature	Use this diagnosis parameter to check the functionality of the PT 1000 temperature sensor.
Measuring tube damping	A deviation from the reference status can be caused by a change in measuring tube damping, e.g. from mechanical changes (coating buildup, corrosion, abrasion).
Sensor symmetry	Use this diagnosis parameter to determine whether the sensor signals are symmetrical.
Operating frequency fluctuation	A deviation in the operating frequency fluctuation indicates possible gas in the fluid.
Tube damping fluctuation	A deviation in the tube damping fluctuation indicates possible gas in the fluid.

6.6 Adjustment

6.6.1 Zero point adjustment

The measuring device is calibrated with state-of-the-art technology. The zero point obtained in this way is printed on the nameplate.

Calibration takes place under reference operating conditions → 107.

Consequently, zero point adjustment is **not** necessary.

Experience shows that the zero point adjustment is advisable only in special cases:

- To achieve highest measuring accuracy also at very small flow rates.
- Under extreme process or operating conditions (e.g. very high process temperatures or very high viscosity fluids).

Preconditions for a zero point adjustment

Note the following before you perform a zero point adjustment:

- A zero point adjustment can be performed only with fluids that contain no gas or solid contents.
- Zero point adjustment is performed with the measuring tubes completely filled and at zero flow ($v = 0$ m/s). This can be achieved, for example, with shutoff valves upstream and/or downstream of the sensor or by using existing valves and gates.
 - Normal operation → Valves 1 and 2 open
 - Zero point adjustment *with* pump pressure → Valve 1 open / valve 2 closed
 - Zero point adjustment *without* pump pressure → Valve 1 closed / valve 2 open

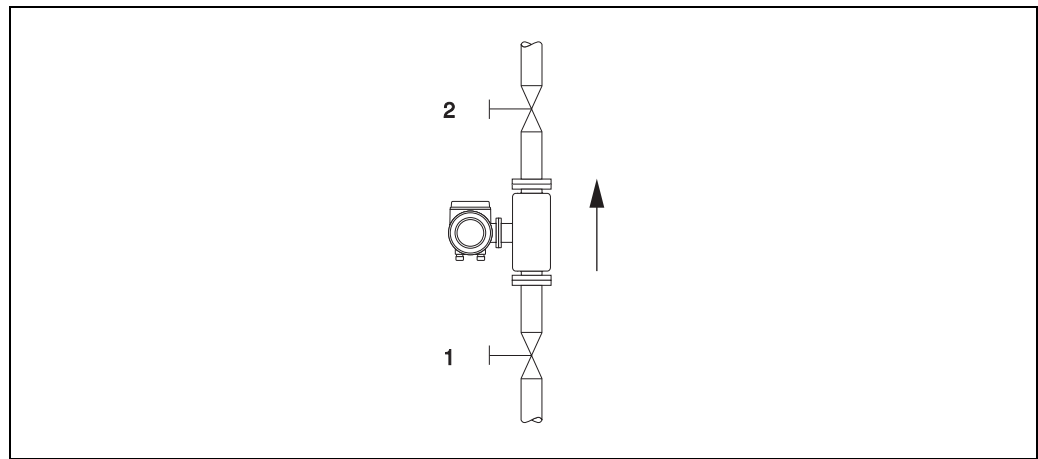

Fig. 35: Zero point adjustment and shutoff valves



Caution!

- If the fluid is very difficult to measure (e.g. containing entrained solids or gas) it may prove impossible to obtain a stable zero point despite repeated zero point adjustments. In instances of this nature, please contact your Endress+Hauser service center.
- You can view the currently valid zero point value using the following function:
 - Local display: HOME → [E] → [+] → BASIC FUNCTIONS → ADJUSTMENT ZEROPOINT
 - FOUNDATION Fieldbus interface/configuration program: Transducer Block → "Sensor Data - Zeropoint" parameter

















Note!

The zero point adjustment can be carried out as follows:

- Via the FOUNDATION Fieldbus configuration program in the Transducer Block
- Via the Discrete Output Function Block
- Via the local display (option)

Performing zero point adjustment using the local display

1. Operate the system until operating conditions have settled.
2. Stop the flow ($v = 0$ m/s).
3. Check the shutoff valves for leaks.
4. Check that operating pressure is correct.
5. Now perform the adjustment as follows:

Key	Procedure	Display text
	HOME position → enter the operating matrix	> GROUP SELECTION < MEASURED VALUES
	Select the "PROCESS PARAMETER" function group	> GROUP SELECTION < PROCESS PARAMETER
	Select the desired function "ZERO ADJUST".	ZERO ADJUST CANCEL
	When you press  you are automatically prompted to enter the access code if the function matrix is still disabled.	CODE ENTRY ***
	Enter code (80 = factory setting)	CODE ENTRY 80
	Confirm code entry. The "ZERO ADJUST" function then appears again on the display.	PROGRAMMING ENABLED ZERO ADJUST. CANCEL
	Select "START"	ZERO ADJUST. START
	Confirm entry with the E-key. A security query appears on the display.	SURE? NO
	Select "YES"	SURE? YES
	Confirm entry with the E-key. Zero point adjustment is now started. The message on the right appears on the display for 30 to 60 seconds while zero point adjustment is in progress. If the flow in the pipe exceeds 0.1 m/s, the following error message appears on the display: "ZERO ADJUST NOT POSSIBLE". When the zero point adjustment is completed, the "ZERO ADJUST." function reappears on the display.	ZERO ADJUST. RUNNING ZERO ADJUST. CANCEL
	The new zero point value is displayed when the Enter key is pressed.	ZERO POINT
	Press  simultaneously → HOME position	

Performing zero point adjustment with a configuration program

1. Operate the system until operating conditions have settled.
2. Stop the flow ($v = 0$ m/s).
3. Check the shutoff valves for leaks.
4. Check that operating pressure is correct.
5. Open the configuration program and then the Resource Block.
6. Use the WRITE_LOCK parameter to check whether hardware write protection is deactivated:
 - Write protection activated = LOCKED
 - Write protection deactivated = NOT LOCKED
 Deactivate the write protection if necessary →  45.
7. Open the Transducer Block.
8. Enable the programming mode:
 - Enter the enable code in the "Access Code" parameter (default = 83).
 - The "Access - Status" parameter should now display "Unlocked Customer".
9. Start zero point adjustment:
 - In the "Zero Point Adjustment" parameter, select "START".
 - Start the adjustment procedure by sending this setting to the field device. If the flow of fluid in the pipe exceeds 0.1 m/s, the error message #731 (adjustment is not possible) appears in the "Diag. - Act. Sys. Condition" parameter.
10. Close the configuration program.

6.6.2 Density adjustment

It is always advisable to perform density adjustment when optimum measuring accuracy is required for calculating density-dependent values.

1-point density adjustment (with one fluid):

This type of density adjustment is necessary under the following circumstances:

- The sensor does not measure exactly the density value that the user expects on the basis of laboratory analyses.
- The fluid properties are outside the measuring points set at the factory, or the reference operating conditions used to calibrate the measuring device.
- The system is used exclusively to measure a fluid's density which must be registered to a high degree of accuracy under constant conditions.
Example: Brix density measurement for apple juice.

2-point density adjustment (with two fluids):

This type of adjustment is always to be carried out if the measuring tubes have been mechanically altered by, e.g. material buildup, abrasion or corrosion. In such cases, the resonant frequency of the measuring tubes has been affected by these factors and is no longer compatible with the calibration data set at the factory. The 2-point density adjustment takes these mechanically-based changes into account and calculates new, adjusted calibration data.









Performing 1- or 2-point density adjustment via the local display





Caution!

- Onsite density adjustment can be performed only if the user has detailed knowledge of the fluid density, obtained for example from detailed laboratory analyses.
- The target density value specified in this way must not deviate from the measured fluid density by more than $\pm 10\%$.
- An error in defining the target density affects all calculated density and volume functions.
- The 2-point density adjustment is only possible if both target density values are different from each other by at least 0.2 kg/l. Otherwise the error message #731 (adjustment is not possible) appears on the display.

- Density adjustment changes the factory density calibration values or the calibration values set by the service technician.
 - The functions outlined in the following instructions are described in detail in the "Description of Device Functions" manual.
1. Fill the sensor with fluid. Make sure that the measuring tubes are completely filled and that liquids are free of gas bubbles.
 2. Wait until the temperature difference between fluid and measuring tube has equalized. The time you have to wait for equalization depends on the fluid and the temperature level.
 3. Using the local display, select the SETPOINT DENSITY function in the function matrix and perform density adjustment as follows:





Function No.	Function name	Setting to be selected ( or ) (to next function with )
6482	DENSITY ADJUST MODE	Use  to select a 1- or 2-point adjustment.  Note! When you press  you are automatically prompted to enter the access code if the function matrix is still disabled. Enter the code.
6483	DENSITY SET VALUE 1	Use  to enter the target density of the first fluid and press  to save this value (input range = actual density value $\pm 10\%$).





6484	MEASURE FLUID 1	Use  to select START and press  . The message "DENSITY MEASUREMENT RUNNING" appears on the display for approximately 10 seconds. During this time Promass measures the current density of the first fluid (measured density value).
------	-----------------	-------------------------------------------------------------------------------------------------------------------------------------------------------------------------------------------------------------------------------------------------------------------------------------------------------------------------------------------------------------------------------------------------------------





For 2-point density adjustment only:

6485	DENSITY SET VALUE 2	Use  to enter the target density of the second fluid and press  to save this value (input range = actual density value $\pm 10\%$).
6486	MEASURE FLUID 2	Use  to select START and press  . The message "DENSITY MEASUREMENT RUNNING" appears on the display for approximately 10 seconds. During this time Promass measures the current density of the second fluid (measured density value).



6487	DENSITY ADJUSTMENT	Use  to select DENSITY ADJUSTMENT and press  . Promass compares the measured density value and the target density value and calculates the new density coefficient.
6488	RESTORE ORIGINAL	If density adjustment does not complete correctly, you can select the RESTORE ORIGINAL function to reactivate the default density coefficient.



Back to the HOME position: → Press and hold down Esc key () for longer than three seconds or → Repeatedly press and release Esc key () → Exit the function matrix step by step		
----------------------------------------------------------------------------------------------------------------------------------------------------------------------------------------------------------------------------------------------------------------------------------------------------------------------------------------------------------------	--	--

Performing 1-or 2-point density adjustment with FF configuration program:**Caution!**

- Density adjustment can be performed only if the user has detailed knowledge of the fluid density, obtained for example from detailed laboratory analyses.
- The target density value specified in this way must not deviate from the measured fluid density by more than $\pm 10\%$.
- An error in defining the target density affects all calculated density and volume functions.
- Density adjustment changes the factory density calibration values or the calibration values set by the service technician.
- The 2-point density adjustment is only possible if both target density values are different from each other by at least 0.2 kg/l. Otherwise the error message #731 (adjustment is not possible) appears in the "Diag. - Act. Sys. Condition" parameter.
- The functions outlined in the following instructions are described in detail in the "Description of Device Functions" manual.

1. Fill the sensor with fluid. Make sure that the measuring tubes are completely filled and that liquids are free of gas bubbles.
2. Wait until the temperature difference between fluid and measuring tube has equalized. The time you have to wait for equalization depends on the fluid and the temperature level.
3. Open the configuration program and then the Resource Block.
4. Use the WRITE_LOCK parameter to check whether hardware write protection is deactivated:
 - Write protection activated = LOCKED
 - Write protection deactivated = NOT LOCKED
 Deactivate the write protection if necessary → 45.
5. Open the Transducer Block.
6. Enable the programming mode:
 - Enter the enable code in the "Access Code" parameter (default = 83).
 - The "Access - Status" parameter should now display "Unlocked Customer".
7. In the "Adj. - Dens.Adj.Mode" parameter, select the "1-Point" setting (for 1-point density adjustment) or "2-Point" (for 2-point density adjustment) and send this setting to the field device.
8. In the "Adj. - Dens.Set.Value 1" parameter, enter the desired target density value (input range = current density value $\pm 10\%$). Send this value to the field device.
9. In the "Adj. - Meas.Fluid 1" parameter, select "START" and send this setting to the field device. The measuring device measures the current density of the fluid (measured density value) for ten seconds.
10. Only for 2-point density adjustment: In the "Adj. - Dens.Set.Value 2" parameter, enter the desired target density value of the second fluid (input range = current density value $\pm 10\%$). Send this value to the field device.
11. Only for 2-point density adjustment: In the "Adj. - Meas.Fluid 2" parameter, select "START" and send this setting to the field device. The measuring device measures the current density of the second fluid (measured density value) for ten seconds.
12. In the "Adj. - Dens. Adjustment" parameter, select "START".
Start the density adjustment procedure by sending this setting to the field device. The measuring device compares the measured density value and the target density value of the fluid and calculates the new density coefficient.
13. If density adjustment does not complete correctly, you can select the "Density Adjustment - Restore Original" parameter to reactivate the default density coefficients.
14. Close the configuration program.

6.7 Gas measurement

This measuring device is not only suitable for measuring liquid flow. Direct mass measurement based on the Coriolis principle is also possible for measuring the flow rate of gases.



Note!

- Only mass flow and corrected volume flow can be measured and output with the gas measurement mode. Note that direct density and/or volume measurement is not possible.
- The flow ranges and measuring accuracy that apply to gas measurement are not the same as those for liquids.

Function settings for gas measurement using the local display

See Quick Setup "Gas Measurement" → 54

Function settings for gas measurement using FF configuration program:

1. Open the configuration program and then the Resource Block.
2. Use the WRITE_LOCK parameter to check whether hardware write protection is deactivated:
 - Write protection activated = LOCKED
 - Write protection deactivated = NOT LOCKED

Deactivate the write protection if necessary → 45.
3. Open the Transducer Block.
4. Enable the programming mode:
 - Enter the enable code in the "Access Code" parameter (default = 83).
 - The "Access - Status" parameter should now display "Unlocked Customer".
5. Empty pipe detection has to be disabled so that measurement can be performed even at low gas pressures.

Therefore, set the "EPD - Empty Pipe Detection" parameter to OFF.
6. On account of the low mass flow involved when gas flows are measured, it is advisable not to use low flow cut off.

Therefore, set the "Low Flow Cut Off - Assign" parameter to OFF.
7. If the "Low Flow Cut Off - Assign" parameter was not set to OFF, configure the following parameters as follows:
 - "Low Flow Cut Off - On-Value" parameter:

Flow rates for gas measurements are low, so the value for the switch-on point (= low flow cut off) must be correspondingly low.

Recommended setting: 0.0000 [unit]
 - "Low Flow Cut Off - Off-Value" parameter:

Enter the switch-off point as a positive hysteresis in %, referenced to the switch-on point.

Default value: 50%

Corrected volume measurement with gas:

Certain other parameters have to be configured if corrected volume flow (e.g. in Nm³/h) is to be measured and output instead of mass flow (e.g. in kg/h). The procedure is as follows:

8. In the "System Unit - Corr.Volume Flow" parameter, select the engineering unit for corrected volume flow.
9. In the "System Unit - Ref. Density" parameter, select the engineering unit for reference density.
10. Set the "Ref.Param. - Corr.Vol.Calculation" parameter to "Fixed Ref.Density".

11. In the "Reference Param. - Fixed Reference Density" parameter, enter a value for the gas-dependent reference density (= density at reference temperature and reference pressure). Example for air: reference density = 1.2928 kg/Nm³ (at 0 °C and 1.013 bar)

 Note!

Corrected volume flow can also be forwarded to other Function Blocks and higher-order process-control systems as a process variable. Please also observe the necessary settings in the Analog Input Function Block (see the "Description of Device Functions" manual).

12. Close the configuration program.

6.8 Rupture disk

Sensor housings with integrated rupture disks are optionally available.



Warning!

- Make sure that the function and operation of the rupture disk is not impeded through the installation. Triggering overpressure in the housing as stated on the indication label. Take adequate precautions to ensure that no damage occurs, and risk to human life is ruled out, if the rupture disk is triggered.

Rupture disk: Burst pressure 10 to 15 bar (145 to 218 psi)

(Promass X: 5,5 to 6,5 bar (80 to 94 psi))

- Please note that the housing can no longer assume a secondary containment function if a rupture disk is used.
- It is not permitted to open the connections or remove the rupture disk.



Caution!

- Rupture disks can not be combined with separately available heating jacket (except Promass A).
- The existing connection nozzles are not designed for a rinse or pressure monitoring function.



Note!

- Before commissioning, please remove the transport protection of the rupture disk.
- Please note the indication labels.

6.9 Purge and pressure monitoring connections

The sensor housing protects the inner electronics and mechanics and is filled with dry nitrogen. Beyond that, up to a specified measuring pressure it additionally serves as secondary containment.



Warning!

For a process pressure above the specified containment pressure, the housing does not serve as an additional secondary containment. If there is a danger of measuring tube failure due to process characteristics, e.g. with corrosive process fluids, we recommend the use of sensors whose housing is equipped with special pressure monitoring connections (ordering option). With the help of these connections, fluid collected in the housing in the event of tube failure can be drained off. This diminishes the danger of mechanical overload of the housing, which could lead to a housing failure and accordingly is connected with an increased danger potential. These connections can also be used for gas purging (gas detection).

The following instructions apply to handling sensors with purge or pressure monitoring connections:

- Do not open the purge connections unless the containment can be filled immediately with a dry inert gas.
- Use only low gauge pressure to purge. Maximum pressure 5 bar (72,5 psi).

6.10 Data storage device (HistoROM), F-CHIP

At Endress+Hauser, the term HistoROM refers to various types of data storage modules on which process and measuring device data are stored. By plugging and unplugging such modules, device configurations can be duplicated onto other measuring devices to cite just one example.

6.10.1 HistoROM/S-DAT (sensor-DAT)

The S-DAT is an exchangeable data storage device in which all sensor relevant parameters are stored, i.e., diameter, serial number, calibration factor, zero point.

6.10.2 HistoROM/T-DAT (transmitter-DAT)



The T-DAT is an exchangeable data storage device in which all transmitter parameters and settings are stored.

Storing of specific parameter settings from the EEPROM to the T-DAT and vice versa has to be carried out by the user (= manual backup function). Please refer to →  56 for a description of the related function (T-DAT SAVE/LOAD) and the exact procedure for managing data.

6.10.3 F-CHIP (Function-Chip)

The F-Chip is a microprocessor chip that contains additional software packages that extend the functionality and application possibilities of the transmitter.

In the case of a later upgrade, the F-Chip can be ordered as an accessory and can simply be plugged on to the I/O board. After start up, the software is immediately made available to the transmitter.

- Accessories →  73
- Plugging onto the I/O board →  90



Caution!

To ensure an unambiguous assignment, the F-CHIP is coded with the transmitter serial number once it is plugged in. Thus, it cannot be reused with other measuring devices.

7 Maintenance

No special maintenance work is required.

7.1 Exterior cleaning

When cleaning the exterior of measuring devices, always use cleaning agents that do not attack the surface of the housing and the seals.

7.2 Cleaning with pigs (Promass H, I, S, P)

If pigs are used for cleaning, it is essential to take the inside diameters of measuring tube and process connection into account. Technical Information →  99

7.3 Replacing seals

Under normal circumstances, fluid wetted seals of the Promass A sensors do not require replacement. Replacement is necessary only in special circumstances, for example if aggressive or corrosive fluids are incompatible with the seal material.



Note!

- The period between changes depends on the fluid properties and on the frequency of cleaning cycles in the case of CIP/SIP cleaning.
- Replacement seals (accessories)

8 Accessories

Various accessories, which can be ordered separately from Endress+Hauser, are available for the transmitter and the sensor. Detailed information on the order code in question can be obtained from your Endress+Hauser representative.

8.1 Device-specific accessories

Accessory	Description	Order code
Promass 83 transmitter FOUNDATION Fieldbus	Transmitter for replacement or for stock. Use the order code to define the following specifications: <ul style="list-style-type: none"> – Approvals – Degree of protection / version – Cable entry, – Display / power supply / operation – Software – Outputs / inputs 	83XXX - XXXXX * * * * *
Software package for Promass 83 FOUNDATION Fieldbus	Software add-ons on F-Chip, can be ordered individually: <ul style="list-style-type: none"> – Advanced diagnostics – Concentration measurement – Viscosity 	DK8SO - *

8.2 Measuring principle-specific accessories

Accessory	Description	Order code
Mounting set for transmitter	Mounting set for wall-mount housing (remote version). Suitable for: <ul style="list-style-type: none"> – Wall mounting – Pipe mounting – Installation in control panel Mounting set for aluminum field housing: Suitable for pipe mounting (3/4" to 3")	DK8WM - *
Post mounting set for the Promass A sensor	Post mounting set for the Promass A	DK8AS - * *
Mounting set for the Promass A sensor	Mounting set for Promass A, comprising: <ul style="list-style-type: none"> – 2 process connections – Seals 	DK8MS - * * * * *
Set of seals for sensor	For regular replacement of the seals of the Promass A sensors. Set consists of two seals.	DKS - * * *
Memograph M graphic display recorder	The Memograph M graphic display recorder provides information on all the relevant process variables. Measured values are recorded correctly, limit values are monitored and measuring points analyzed. The data are stored in the 256 MB internal memory and also on a DSD card or USB stick. Memograph M boasts a modular design, intuitive operation and a comprehensive security concept. The ReadWin® 2000 PC software is part of the standard package and is used for configuring, visualizing and archiving the data captured. The mathematics channels which are optionally available enable continuous monitoring of specific power consumption, boiler efficiency and other parameters which are important for efficient energy management.	RSG40 - * * * * * * * * *

8.3 Service-specific accessories

Accessory	Description	Order code
Applicator	<p>Software for selecting and sizing Endress+Hauser measuring devices:</p> <ul style="list-style-type: none"> ■ Calculation of all the necessary data for identifying the optimum flowmeter: e.g. nominal diameter, pressure loss, accuracy or process connections ■ Graphic illustration of the calculation results <p>Administration, documentation and access to all project-related data and parameters over the entire life cycle of a project.</p> <p>Applicator is available:</p> <ul style="list-style-type: none"> ■ Via the Internet: https://wapps.endress.com/applicator ■ On CD-ROM for local PC installation. 	DXA80 – *
W@M	<p>Life cycle management for your plant</p> <p>W@M supports you with a wide range of software applications over the entire process: from planning and procurement, to the installation, commissioning and operation of the measuring devices. All the relevant device information, such as the device status, spare parts and device-specific documentation, is available for every device over the entire life cycle.</p> <p>The application already contains the data of your Endress+Hauser device. Endress+Hauser also takes care of maintaining and updating the data records.</p> <p>W@M is available:</p> <ul style="list-style-type: none"> ■ Via the Internet: www.endress.com/lifecyclemanagement ■ On CD-ROM for local PC installation. 	
Fieldcheck	<p>Tester/simulator for testing flowmeters in the field. When used in conjunction with the "FieldCare" software package, test results can be imported into a database, printed and used for official certification.</p> <p>Contact your Endress+Hauser representative for more information.</p>	50098801
FieldCare	<p>FieldCare is Endress+Hauser's FDT-based plant asset management tool. It can configure all intelligent field units in your system and helps you manage them. By using the status information, it is also a simple but effective way of checking their status and condition.</p>	See the product page on the Endress+Hauser website: www.endress.com
FXA193	<p>The FXA193 service interface connects the device to the PC for configuration via FieldCare.</p>	FXA193 – *

9 Troubleshooting

9.1 Troubleshooting instructions

Always start troubleshooting with the following checklist if faults occur after commissioning or during operation. The routine takes you directly to the cause of the problem and the appropriate remedial measures.



Caution!

In the event of a serious fault, a flowmeter might have to be returned to the manufacturer for repair. Important procedures must be carried out before you return a flowmeter to Endress+Hauser → [6](#).

Always enclose a duly completed "Declaration of contamination" form. You will find a preprinted form at the back of this manual.



Check the display	
No display visible. No connection to the FF host system	<ol style="list-style-type: none"> 1. Check the supply voltage → Terminals 1, 2 2. Check device fuse → 95 85 to 260 V AC: 0.8 A slow-blow / 250 V 20 to 55 V AC and 16 to 62 V DC: 2 A slow-blow / 250 V 3. Measuring electronics defective → order spare parts → 90
No display visible. Connection to the FF host system established however.	<ol style="list-style-type: none"> 1. Check whether the ribbon-cable connector of the display module is correctly plugged into the amplifier board → 90 2. Display module defective → order spare parts → 90 3. Measuring electronics defective → order spare parts → 90
Display texts are in a foreign language.	Switch off power supply. Press and hold down both the / keys and switch on the measuring device. The display text will appear in English (default) and is displayed at maximum contrast.
No connection can be established with the FF host system, even though measured value reading is visible.	Measuring electronics defective → order spare parts → 90



Error messages on display
<p>Errors that occur during commissioning or measuring are displayed immediately. Error messages consist of a variety of icons. The meanings of these icons are as follows (example):</p> <ul style="list-style-type: none"> – Type of error: S = System error, P = Process error – Error message type: f = Fault message, ! = Notice message – FLUID INHOM. = Error designation (e.g. fluid is not homogeneous) – 03:00:05 = Duration of error occurrence (in hours, minutes and seconds) – #702 = Error number <p> Caution! See the information → 42</p>
System error (device error) has occurred → 80
Process error (application error) has occurred → 87











Faulty connection to the fieldbus host system	
No connection can be made between the fieldbus host system and the measuring device. Check the following points:	
Supply voltage Transmitter	Check the supply voltage → terminals 1/2 (Continued on next page)

Device fuse <i>(continued)</i>	Check device fuse →  95 85 to 260 V AC: 0.8 A slow-blow / 250 V 20 to 55 V AC and 16 to 62 V DC: 2 A slow-blow / 250 V
Fieldbus connection	Check the data cable: Terminal 26 = FF + Terminal 27 = FF –
Fieldbus connector (Option)	<ul style="list-style-type: none"> ■ Check pin assignment/wiring →  32 ■ Check connection between connector/fieldbus port. Is the coupling ring tightened correctly?
Fieldbus voltage	Check that a min. bus voltage of 9 V DC is present at terminals 26/27. Permissible range: 9 to 32 V DC
Network structure	Check permissible fieldbus length and number of spurs →  27
Basic current	Is there a basic current of min. 12 mA?
Bus address	Check bus address: make sure there are no double assignments
Bus termination	Is the FOUNDATION Fieldbus-H1 network correctly terminated? Each bus segment must always be terminated with a bus terminator at both ends (start and finish). Otherwise there may be interference in data transmission.
Current consumption, permissible feed current	Check the current consumption of the bus segment: The current consumption of the bus segment in question (= total of basic currents of all fieldbus devices) must not exceed the max. permissible feed current of the fieldbus power supply.
Device Description (DD)	<p>Install the DD if you cannot access the manufacturer-specific parameters.</p> <p> Note! Ensure you use the correct system files for linking the field devices into the host system. Appropriate version information can be called up via the following functions/parameters:</p> <p>Local display:</p> <ul style="list-style-type: none"> ■ HOME → BASIC FUNCTIONS → FOUND. FIELDBUS → INFORMATION → DEVICE REVISION (6243) ■ HOME → BASIC FUNCTIONS → FOUND. FIELDBUS → INFORMATION → DD REVISION (6244) <p>FF configuration program:</p> <ul style="list-style-type: none"> ■ Resource Block → Parameter DEV_REV ■ Resource Block → Parameter DD_REV <p>Example (with local display): Display in the DEVICE REVISION (6243) function → 04 Display in the DD REVISION (6244) function → 01 Device description file (DD) required → 0401.sym / 0401.fo</p>



Problems with configuration of Function Blocks	
Transducer Blocks: The operating mode cannot be set to AUTO.	<p>Check whether the operating mode of the Resource Block is in AUTO mode → Parameter group MODE_BLK / parameter TARGET.</p> <p style="text-align: right;"><i>(Continued on next page)</i></p>

<p>Analog Input fct. block: The operating mode cannot be set to AUTO.</p> <p><i>(continued)</i></p>	<p>There may be several reasons for this. Check the following in sequence:</p> <ol style="list-style-type: none"> 1. Check whether the operating mode of the Analog Input Function Block is in AUTO mode → Parameter group MODE_BLK / parameter TARGET. If not and the mode cannot be set to AUTO, first check the following. 2. Make sure that the CHANNEL parameter (selection process variable) is configured in the Analog Input Function Block → 90. The selection "CHANNEL = 0" (Uninitialized) is not valid. 3. Make sure that the XD_SCALE parameter group (input range, unit) is configured in the Analog Input Function Block → 90 (incl. configuration example) <p> Caution! Make sure that the selected unit is suitable for the process variable selected in the CHANNEL parameter. Otherwise the parameter BLOCK_ERROR will display the error message "Block Configuration Error". In this status the block operating mode cannot be set to AUTO.</p>
<p>Analog Input fct. block: The operating mode cannot be set to AUTO.</p>	<ol style="list-style-type: none"> 4. Make sure that the L_TYPE parameter (type of linearization) is already configured in the Analog Input Function Block → 90. <p> Caution! Make sure that with the type of linearization "Direct" the scaling of the parameter group OUT_SCALE is identical to that of the parameter group XD_SCALE. If set incorrectly the parameter BLOCK_ERROR will display the error message "Block Configuration Error". In this status the block operating mode cannot be set to AUTO. Configuration example → 90</p> <ol style="list-style-type: none"> 5. Check whether the operating mode of the Resource Block is in AUTO mode → Parameter group MODE_BLK/parameter TARGET 6. Make sure that the Function Blocks are correctly interconnected and that this system configuration has been sent to the fieldbus station → 90.
<p>Analog Input Function Block: The operating mode is set to AUTO but the status of the AI output value OUT is BAD or UNCERTAIN.</p>	<ol style="list-style-type: none"> 1. Check whether the operating mode of the Transducer Blocks is set to AUTO → MODE_BLK parameter group / TARGET parameter. Using the various CHANNEL parameters (→ 102) set the Transducer Blocks to the AUTO operating mode. 2. Check whether an error is pending in the "Diagnosis" Transducer Block (base index: 1600) → "Diagnosis" Transducer Block (base index: 1600) → "Diag. - Act.Sys.Condition" parameter. <p>Error messages → 79</p>
<p>Parameters cannot be modified or no write access to parameters.</p>	<ol style="list-style-type: none"> 1. Parameters that only display values or settings cannot be modified! 2. Hardware write protection is enabled → Deactivate the write protection → 90 <p> Note! You can use the parameter WRITE_LOCK in the Resource Block to check whether hardware write protection is activated or deactivated: LOCKED = write protection enabled (activated) UNLOCKED = no write protection (deactivated)</p> <ol style="list-style-type: none"> 3. The block operating mode is wrong. Certain parameters can only be changed in the OOS (out of service) or MAN (manual) mode → Set the operating mode of the block to the necessary mode → MODE_BLK parameter group. 4. The value entered is outside the specified input range for the parameter in question: → Enter suitable value → Increase input range if necessary 5. Transducer Blocks: The programming level is not enabled → Enable by entering the code in the "Access – Code" parameter or by means of the service code in the service parameters. <p><i>(Continued on next page)</i></p>

<p>Transducer Block: The manufacturer-specific parameters are not visible.</p> <p><i>(continued)</i></p>	<p>The device description file (Device Description, DD) has not been loaded into the host system or the configuration program → Load the file into the configuration system.</p> <p>Reference sources of the DD →  90</p> <p> Note! Ensure you use the correct system files for linking the field devices into the host system. Appropriate version information can be called up in the measuring device via the following functions/parameters:</p> <p>Local display:</p> <ul style="list-style-type: none"> ■ HOME → BASIC FUNCTIONS → FOUND. FIELDBUS → INFORMATION → DEVICE REVISION (6243) ■ HOME → BASIC FUNCTIONS → FOUND. FIELDBUS → INFORMATION → DD REVISION (6244) <p>FF configuration program:</p> <ul style="list-style-type: none"> ■ Resource Block → Parameter DEV_REV ■ Resource Block → Parameter DD_REV <p>Example (local display): Display in the DEVICE REVISION (6243) function → 04 Display in the DD REVISION (6244) function → 01 Required device description file (DD) → 0401.sym / 0401.ffo</p>
<p>Analog Input Function Block: The output value OUT is not updated despite having a GOOD status.</p>	<p>Simulation is active → Deactivate simulation via parameter group SIMULATE.</p>
<p>Error messages</p>	
<p>Error messages in the FF configuration program →  79 Error messages on the local display →  79</p>	
<p>▼</p>	
<p>Other error (without error message)</p>	
<p>Some other error has occurred.</p>	<p>Diagnosis and rectification →  89</p>

9.2 System/process error messages

General notes

The flowmeter assigns current system and process errors to two error message types in accordance with a predefined algorithm and classifies them accordingly:

Error message type "Fault message":

- A message of this type immediately interrupts or stops measurement.
- Presentation on the FOUNDATION Fieldbus → Fault messages are transmitted to subsequent Function Blocks or higher-level process control systems by means of the status "BAD" of the AI output parameter OUT (AI Block).
- Local display → A flashing lightning symbol (⚡) is displayed

Error message type "Notice message":

- Measurement continues despite this message.
- Presentation on the FOUNDATION Fieldbus → Notice messages are transmitted to subsequent Function Blocks or higher-level process control systems by means of the status "UNCERTAIN" of the AI output parameter OUT (AI Block).
- Local display → A flashing exclamation mark (!) is displayed.

Serious system errors, e.g. module defects, are always classed and displayed as "fault messages" by the measuring device. Simulations in the "Flow" Transducer Block and positive zero return, on the other hand, are identified as "notice messages" only.

Error messages in the FF configuration programs → 80

System and process errors are recognized and reported in the Transducer Blocks. Such errors are displayed via the following parameters specified in the FOUNDATION Fieldbus specification:

- BLOCK_ERR
- Transducer Error

In the "Diagnosis" Transducer Block (base index: 1600), detailed reasons for errors and device status messages are displayed by means of the "Diag. - Act.Sys.Condition" parameter (manufacturer-specific) → Table.

Error messages on the local display → 80

You will find more details on how error messages are presented on →  42.

9.2.1 List of system error messages

No.	Error messages: FOUNDATION Fieldbus (FF)* (Local display)	Transducer Block error messages "Diagnosis" Transducer Block	Analog Input Function Block error messages	Reason for error/rectification (spare parts → 90)
<p>* With FOUNDATION Fieldbus, error messages are displayed in the "Diagnosis" Transducer Block (base index: 1600) by means of the "Diag. – Act.Sys.Condition" parameter (manufacturer-specific).</p> <p>S = System error † = Fault message (with an effect on operation) ! = Notice message (without any effect on operation)</p>				
No. # 0xx → Hardware error				
001	<i>Device status message (FF):</i> Critical Failure – Err. No. 001 <i>Local display:</i> S: CRITICAL FAILURE †: # 001	BLOCK_ERR = Device needs maintenance now	OUT. QUALITY = BAD	<i>Cause:</i> ROM/RAM error. Error when accessing the program memory (ROM) or random access memory (RAM) of the processor. <i>Remedy:</i> Replace the amplifier board.
		Transducer_Error = Electronics failure	OUT. SUBSTATUS = Device Failure	
			BLOCK_ERR = Input Failure (faulty input value from Transducer Blocks)	
011	<i>Device status message (FF):</i> Amplifier EEPROM failure – Err. No. 011 <i>Local display:</i> S: AMP HW EEPROM †: # 011	BLOCK_ERR = Device needs maintenance now	OUT. QUALITY = BAD	<i>Cause:</i> Measuring amplifier has faulty EEPROM <i>Remedy:</i> Replace the amplifier board.
		Transducer_Error = Data integrity error	OUT. SUBSTATUS = Device Failure	
			BLOCK_ERR = Input Failure (faulty input value from Transducer Blocks)	
012	<i>Device status message (FF):</i> Amplifier EEPROM data inconsistent – Err. No. 012 <i>Local display:</i> S: AMP SW EEPROM †: # 012	BLOCK_ERR = Device needs maintenance now	OUT. QUALITY = BAD	<i>Cause:</i> Error when accessing data of the measuring amplifier EEPROM <i>Remedy:</i> Perform a "warm start" (= start the measuring system without disconnecting main power). ■ FF: "Diagnosis" Transducer Block (base index: 1600) → "Sys. – Reset" parameter RESTART SYSTEM ■ Local display: SUPERVISION → SYSTEM → OPERATION → SYSTEM RESET (→ RESTART SYSTEM)
		Transducer_Error = Data integrity error	OUT. SUBSTATUS = Device Failure	
			BLOCK_ERR = Input Failure (faulty input value from Transducer Blocks)	
031	<i>Device status message (FF):</i> S-DAT failure / not inserted – Err. No. 031 <i>Local display:</i> S: SENSOR HW DAT †: # 031	BLOCK_ERR = Device needs maintenance now	OUT. QUALITY = BAD	<i>Cause:</i> 1. S-DAT is not correctly plugged into amplifier board (or is missing). 2. S-DAT is defective. <i>Remedy:</i> 1. Check whether the S-DAT is correctly plugged into the amplifier board. 2. Replace the S-DAT if it is defective. Check whether the new replacement DAT is compatible with the existing electronics. Check the: - Spare part set number - Hardware revision code 3. Replace measuring electronics boards if necessary. 4. Plug S-DAT into amplifier board.
		Transducer_Error = Electronics failure	OUT. SUBSTATUS = Device Failure	
			BLOCK_ERR = Input Failure (faulty input value from Transducer Blocks)	
032	<i>Device status message (FF):</i> S-DAT data inconsistent – Err. No. 032 <i>Local display:</i> S: SENSOR SW DAT †: # 032	BLOCK_ERR = Device needs maintenance now	OUT. QUALITY = BAD	2. Replace the S-DAT if it is defective. Check whether the new replacement DAT is compatible with the existing electronics. Check the: - Spare part set number - Hardware revision code 3. Replace measuring electronics boards if necessary. 4. Plug S-DAT into amplifier board.
		Transducer_Error = Data integrity error	OUT. SUBSTATUS = Device Failure	
			BLOCK_ERR = Input Failure (faulty input value from Transducer Blocks)	

No.	Error messages: FOUNDATION Fieldbus (FF)* (Local display)	Transducer Block error messages "Diagnosis" Transducer Block	Analog Input Function Block error messages	Reason for error/rectification (spare parts → 90)
041	<i>Device status message (FF):</i> T-DAT failure – Err. No. 041 <i>Local display:</i> S: TRANSM. HW DAT ‡: # 041	BLOCK_ERR = Device needs maintenance now	OUT. QUALITY = BAD	<i>Cause:</i> 1. T-DAT is not correctly plugged into amplifier board (or is missing). 2. T-DAT is faulty <i>Remedy:</i> 1. Check whether the T-DAT is correctly plugged into the amplifier board. 2. Replace T-DAT if faulty. Check whether the new replacement DAT is compatible with the existing electronics. Check the: - Spare part set number - Hardware revision code 3. Replace measuring electronics boards if necessary. 4. Plug T-DAT into amplifier board.
Transducer_Error = Electronics failure	OUT. SUBSTATUS = Device Failure	BLOCK_ERR = Input Failure (faulty input value from Transducer Blocks)		
042	<i>Device status message (FF):</i> T-DAT data inconsistent – Err. No. 042 <i>Local display:</i> S: TRANSM. SW DAT ‡: # 042	BLOCK_ERR = Device needs maintenance now	OUT. QUALITY = BAD	
Transducer_Error = Data integrity error	OUT. SUBSTATUS = Device Failure	BLOCK_ERR = Input Failure (faulty input value from Transducer Blocks)		
061	<i>Device status message (FF):</i> F-CHIP failure – Err. No. 061 <i>Local display:</i> S: HW F-CHIP ‡: # 061	BLOCK_ERR = Device needs maintenance now	OUT. QUALITY = BAD	1. Replace the F-Chip. 2. Plug the F-Chip into the I/O board.
Transducer_Error = Electronics failure	OUT. SUBSTATUS = Device Failure	BLOCK_ERR = Input Failure (faulty input value from Transducer Blocks)		
No. # 1xx → Software error				
121	<i>Device status message (FF):</i> Software compatibility problem amplifier – I/O module – Err. No. 121 <i>Local display:</i> S: A / C COMPATIB. !: # 121	BLOCK_ERR = Device needs maintenance now	OUT. QUALITY = BAD	<i>Cause:</i> Due to different software versions, I/O board and amplifier board are only partially compatible (possibly restricted functionality).  Note! – This is indicated on the display as a warning message for only 30 seconds (with entry in error history). – This situation in which the software versions differ can occur if only one electronics board has been exchanged; the extended software functionality is not available. The previously existing software functionality is still available and measurement operation is possible.
Transducer_Error = I/O failure (input/output error)	OUT. SUBSTATUS = Device Failure	BLOCK_ERR = Input Failure (faulty input value from Transducer Blocks)		

No.	Error messages: FOUNDATION Fieldbus (FF)* (Local display)	Transducer Block error messages "Diagnosis" Transducer Block	Analog Input Function Block error messages	Reason for error/rectification (spare parts → 90)
No. # 2xx → Error in DAT / no communication				
205	<i>Device status message (FF):</i> Save to T-DAT failed – Err. No. 205 <i>Local display:</i> S: LOAD T-DAT !: # 205	BLOCK_ERR = Device needs maintenance now Transducer_Error = Electronics failure	OUT. QUALITY = BAD OUT. SUBSTATUS = Device Failure BLOCK_ERR = Input Failure (faulty input value from Transducer Blocks)	<i>Cause:</i> Data backup (download) to T-DAT failed or error when accessing the calibration values stored in the T-DAT (upload). <i>Remedy:</i> 1. Check whether the T-DAT is correctly plugged into the amplifier board. 2. Replace T-DAT if faulty. Before replacing the DAT, check that the new, replacement DAT is compatible with the measuring electronics. Check the: – Spare part set number – Hardware revision code 3. Replace measuring electronics boards if necessary.
206	<i>Device status message (FF):</i> Restore from T-DAT failed – Err. No. 206 <i>Local display:</i> S: SAVE T-DAT !: # 206	BLOCK_ERR = Device needs maintenance now Transducer_Error = Electronics failure	OUT. QUALITY = BAD OUT. SUBSTATUS = Device Failure BLOCK_ERR = Input Failure (faulty input value from Transducer Blocks)	3. Replace measuring electronics boards if necessary.
251	<i>Device status message (FF):</i> Communication failure amplifier – Err. No. 251 <i>Local display:</i> S: COMMUNICAT.AMP !: # 251	BLOCK_ERR = Device needs maintenance now Transducer_Error = Electronics failure	OUT. QUALITY = BAD OUT. SUBSTATUS = Device Failure BLOCK_ERR = Input Failure (faulty input value from Transducer Blocks)	<i>Cause:</i> Internal communication fault on the amplifier board. <i>Remedy:</i> Replace the amplifier board.
261	<i>Device status message (FF):</i> Communication failure I/O – Err. No. 261 <i>Local display:</i> S: COMMUNICAT. I/O !: # 261	BLOCK_ERR = Device needs maintenance now Transducer_Error = I/O failure (communication problems)	OUT. QUALITY = BAD OUT. SUBSTATUS = Device Failure BLOCK_ERR = Input Failure (faulty input value from Transducer Blocks)	<i>Cause:</i> Communication error. No data reception between amplifier and I/O board or faulty internal data transfer. <i>Remedy:</i> Check whether the electronics boards are correctly inserted in their holders.
No. # 3xx → System limits exceeded				
379 380	<i>Device status message (FF):</i> Measuring tube is outside the range – Err. No. 379 / 380 <i>Local display:</i> S: FREQ. LIM !: # 379 /380	BLOCK_ERR = Device needs maintenance now Transducer_Error = Mechanical failure	OUT. QUALITY = BAD OUT. SUBSTATUS = Sensor Failure BLOCK_ERR = Input Failure (faulty input value from Transducer Blocks)	<i>Cause:</i> The measuring tube oscillation frequency is outside the permitted range. <i>Causes:</i> – Damaged measuring tube – Sensor defective or damaged <i>Remedy:</i> Contact your E+H service organization.

No.	Error messages: FOUNDATION Fieldbus (FF)* (Local display)	Transducer Block error messages "Diagnosis" Transducer Block	Analog Input Function Block error messages	Reason for error/rectification (spare parts → 90)
381	<p><i>Device status message (FF):</i> Tube temperature sensor defect – Err. No. 381</p> <p><i>Local display:</i> S: TOL. COIL CURR. ‡: # 381</p>	<p>BLOCK_ERR = Device needs maintenance now</p> <p>Transducer_Error = Mechanical failure</p>	<p>OUT. QUALITY = BAD</p> <p>OUT. SUBSTATUS = Sensor Failure</p> <p>BLOCK_ERR = Input Failure (faulty input value from Transducer Blocks)</p>	<p><i>Cause:</i> The temperature sensor on the measuring tube is probably defective.</p> <p><i>Remedy:</i> Check the following electrical connections before you contact your E+H service organization: – Verify that the sensor signal cable connector is correctly plugged into the amplifier board. → 91</p>
382	<p><i>Device status message (FF):</i> Tube temperature sensor defect – Err. No. 382</p> <p><i>Local display:</i> S: FLUIDTEMP.MAX. ‡: # 382</p>	<p>BLOCK_ERR = Device needs maintenance now</p> <p>Transducer_Error = Mechanical failure</p>	<p>OUT. QUALITY = BAD</p> <p>OUT. SUBSTATUS = Sensor Failure</p> <p>BLOCK_ERR = Input Failure (faulty input value from Transducer Blocks)</p>	<p>– Remote version: Check sensor and transmitter terminal connections No. 9 and 10. → 29</p>
383	<p><i>Device status message (FF):</i> Carrier tube sensor defect –Err. No. 383</p> <p><i>Local display:</i> S: CARR.TEMP.MIN ‡: # 383</p>	<p>BLOCK_ERR = Device needs maintenance now</p> <p>Transducer_Error = Mechanical failure</p>	<p>OUT. QUALITY = BAD</p> <p>OUT. SUBSTATUS = Sensor Failure</p> <p>BLOCK_ERR = Input Failure (faulty input value from Transducer Blocks)</p>	<p><i>Cause:</i> The temperature sensor on the carrier tube is probably defective.</p> <p><i>Remedy:</i> Check the following electrical connections before you contact your E+H service organization: – Verify that the sensor signal cable connector is correctly plugged into the amplifier board. – Remote version:</p>
384	<p><i>Device status message (FF):</i> Carrier tube sensor defect –Err. No. 384</p> <p><i>Local display:</i> S: CARR.TEMP.MAX ‡: # 384</p>	<p>BLOCK_ERR = Device needs maintenance now</p> <p>Transducer_Error = Mechanical failure</p>	<p>OUT. QUALITY = BAD</p> <p>OUT. SUBSTATUS = Sensor Failure</p> <p>BLOCK_ERR = Input Failure (faulty input value from Transducer Blocks)</p>	<p>Check sensor and transmitter terminal connections No. 11 and 12. → 29</p>



No.	Error messages: FOUNDATION Fieldbus (FF)* (Local display)	Transducer Block error messages "Diagnosis" Transducer Block	Analog Input Function Block error messages	Reason for error/rectification (spare parts → 90)
385	<p><i>Device status message (FF):</i> Measuring tube coil defect – Err. No. 385</p> <p><i>Local display:</i> S: INLET SENS t: # 385</p>	<p>BLOCK_ERR = Device needs maintenance now</p> <p>Transducer_Error = Mechanical failure</p>	<p>OUT. QUALITY = BAD</p> <p>OUT. SUBSTATUS = Sensor Failure</p> <p>BLOCK_ERR = Input Failure (faulty input value from Transducer Blocks)</p>	<p><i>Cause:</i> One of the measuring tube sensor coils is probably defective (inlet or outlet).</p> <p><i>Remedy:</i> Check the following electrical connections before you contact your E+H service organization: – Verify that the sensor signal cable connector is correctly plugged into the amplifier board. – Remote version: Check sensor and transmitter terminal connections No. 4, 5, 6 and 7 → 29</p>
386	<p><i>Device status message (FF):</i> Measuring tube coil defect – Err. No. 386</p> <p><i>Local display:</i> S: OUTL.SENS.DEF. t: # 386</p>	<p>BLOCK_ERR = Device needs maintenance now</p> <p>Transducer_Error = Mechanical failure</p>	<p>OUT. QUALITY = BAD</p> <p>OUT. SUBSTATUS = Sensor Failure</p> <p>BLOCK_ERR = Input Failure (faulty input value from Transducer Blocks)</p>	
387	<p><i>Device status message (FF):</i> Measuring tube coil defect – Err. No. 387</p> <p><i>Local display:</i> S: SEN.ASY.EXCEED t: # 387</p>	<p>BLOCK_ERR = Device needs maintenance now</p> <p>Transducer_Error = Mechanical failure</p>	<p>OUT. QUALITY = BAD</p> <p>OUT. SUBSTATUS = Sensor Failure</p> <p>BLOCK_ERR = Input Failure (faulty input value from Transducer Blocks)</p>	
388 389 390	<p><i>Device status message (FF):</i> Amplifier error – Err. No. 388 / 389 / 390</p> <p><i>Local display:</i> S: AMP. FAULT t: # 388 / 389 / 390</p>	<p>BLOCK_ERR = Device needs maintenance now</p> <p>Transducer_Error = Electronics failure</p>	<p>OUT. QUALITY = BAD</p> <p>OUT. SUBSTATUS = Device Failure</p> <p>BLOCK_ERR = Input Failure (faulty input value from Transducer Blocks)</p>	<p><i>Cause:</i> Amplifier error</p> <p><i>Remedy:</i> Contact your E+H service organization.</p>
No. # 5xx → Application error				
501	<p><i>Device status message (FF):</i> Download device software active – Err. No. 501</p> <p><i>Local display:</i> S: SW.-UPDATE ACT. !: # 501</p>	<p>BLOCK_ERR = Device needs maintenance now</p> <p>Transducer_Error = Mechanical failure</p>	<p>OUT. QUALITY = BAD</p> <p>OUT. SUBSTATUS = Device Failure</p> <p>BLOCK_ERR = Input Failure (faulty input value from Transducer Blocks)</p>	<p><i>Cause:</i> New amplifier or communication software version is being loaded to the device. Currently no other functions are possible.</p> <p><i>Remedy:</i> Wait until process is finished. The device will restart automatically.</p>
502	<p><i>Device status message (FF):</i> Up-/Download device software active – Err. No. 502</p> <p><i>Local display:</i> S: UP-/DOWNLO. ACT. !: # 502</p>	<p>BLOCK_ERR = Device needs maintenance now</p> <p>Transducer_Error = Mechanical failure</p>	<p>OUT. QUALITY = BAD</p> <p>OUT. SUBSTATUS = Device Failure</p> <p>BLOCK_ERR = Input Failure (faulty input value from Transducer Blocks)</p>	<p><i>Cause:</i> Up- or downloading the device data via configuration program. Currently no other functions are possible.</p> <p><i>Remedy:</i> Wait until process is finished.</p>

No.	Error messages: FOUNDATION Fieldbus (FF)* (Local display)	Transducer Block error messages "Diagnosis" Transducer Block	Analog Input Function Block error messages	Reason for error/rectification (spare parts → 90)
No. # 6xx → Simulation mode active				
601	<i>Device status message (FF):</i> Positive zero return active – Err. No. 601 <i>Local display:</i> S: POSITIVE ZERO RETURN !: # 601	BLOCK_ERR = Device needs maintenance now Transducer_Error = General Error	OUT. QUALITY = UNCERTAIN OUT. SUBSTATUS = Non specific	<i>Cause:</i> Positive zero return is active.  Note! This message has the highest display priority. <i>Remedy:</i> Deactivate positive zero return: ■ FF: "Flow" Transducer Block (base index: 1100) → "Sys. - Positive Zero Return" parameter → OFF ■ Local display: BASIC FUNCTIONS → SYSTEM PARAMETERS → CONFIGURATION → POS. ZERO RETURN (→ OFF)
691	<i>Device status message (FF):</i> Simulation failsafe active – Err. No. 691 <i>Local display:</i> S: SIM. FAILSAFE !: # 691	BLOCK_ERR = Simulation active Transducer_Error = General Error	OUT. QUALITY = UNCERTAIN OUT. SUBSTATUS = Non specific	<i>Cause:</i> Simulation of response to error (outputs) is active <i>Remedy:</i> Switch off simulation: ■ FF: "Diagnosis" Transducer Block (base index: 1600) → "Sys. - Sim.Failsafe Mode" parameter → OFF ■ Local display: SUPERVISION → SYSTEM → OPERATION → SIM. FAILSAFE MODE (→ OFF)
692	<i>Device status message (FF):</i> Simulation of measuring active – Err. No. 692 <i>Local display:</i> S: SIM. MEASURAND !: # 692	BLOCK_ERR = Simulation active Transducer_Error = General Error	OUT. QUALITY = UNCERTAIN OUT. SUBSTATUS = Non specific	<i>Cause:</i> Simulation of measured variable is active. <i>Remedy:</i> Switch off simulation: ■ FF: "Flow" Transducer Block (base index: 1400) → "Simulation - Measurand" parameter → OFF ■ Local display: SUPERVISION → SYSTEM → OPERATION → SIM. MEASURAND (→ OFF)
–	No communication to amplifier	BLOCK_ERR = Device needs maintenance now Transducer_Error = General Error	OUT. QUALITY = BAD OUT. SUBSTATUS = Device Failure BLOCK_ERR = Input Failure (faulty input value from Transducer Blocks)	<i>Cause:</i> Communication error. No communication with measuring amplifier. <i>Remedy:</i> 1. Switch power supply off and on again. 2. Check whether the electronics boards are correctly inserted in their holders.
No. # 8xx → Application error				
800	<i>Device status message (FF):</i> Massflow deviation limit – Err. No. 800 <i>Local display:</i> S: M. FL. DEV. LIMIT !: # 800	BLOCK_ERR = Device needs maintenance now Transducer_Error = General Error	OUT. QUALITY = UNCERTAIN OUT. SUBSTATUS = Non specific	<i>Cause:</i> Advanced Diagnostics: The mass flow is outside the limit value, set in the corresponding diagnosis function.
801	<i>Device status message (FF):</i> Density deviation limit – Err. No. 801 <i>Local display:</i> S: DENS. DEV. LIMIT !: # 801	BLOCK_ERR = Device needs maintenance now Transducer_Error = General Error	OUT. QUALITY = UNCERTAIN OUT. SUBSTATUS = Non specific	<i>Cause:</i> Advanced Diagnostics: The density is outside the limit value, set in the corresponding diagnosis function.



No.	Error messages: FOUNDATION Fieldbus (FF)* (Local display)	Transducer Block error messages "Diagnosis" Transducer Block	Analog Input Function Block error messages	Reason for error/rectification (spare parts → 90)
802	<p><i>Device status message (FF):</i> Reference density deviation limit – Err. No. 802</p> <p><i>Local display:</i> S: M. FL. DEV. LIMIT ‡: # 802</p>	<p>BLOCK_ERR = Device needs maintenance now</p> <p>Transducer_Error = General Error</p>	<p>OUT. QUALITY = UNCERTAIN</p> <p>OUT. SUBSTATUS = Non specific Error</p>	<p><i>Cause:</i> Advanced Diagnostics: The reference density is outside the limit value, set in the corresponding diagnosis function.</p>
803	<p><i>Device status message (FF):</i> Temperature deviation limit – Err. No. 803</p> <p><i>Local display:</i> S: TEMP. DEV. LIMIT ‡: # 803</p>	<p>BLOCK_ERR = Device needs maintenance now</p> <p>Transducer_Error = General Error</p>	<p>OUT. QUALITY = UNCERTAIN</p> <p>OUT. SUBSTATUS = Non specific Error</p>	<p><i>Cause:</i> Advanced Diagnostics: The temperature is outside the limit value, set in the corresponding diagnosis function.</p>
804	<p><i>Device status message (FF):</i> Tube damping deviation – Err. No. 804</p> <p><i>Local display:</i> S: DAMP. DEV. LIM. ‡: # 804</p>	<p>BLOCK_ERR = Device needs maintenance now</p> <p>Transducer_Error = General Error</p>	<p>OUT. QUALITY = UNCERTAIN</p> <p>OUT. SUBSTATUS = Non specific Error</p>	<p><i>Cause:</i> Advanced Diagnostics: The tube damping is outside the limit value, set in the corresponding diagnosis function.</p>
805	<p><i>Device status message (FF):</i> El. dyn. sensors limit – Err. No. 805</p> <p><i>Local display:</i> S: E. D. SEN. DEV. LIM. ‡: # 805</p>	<p>BLOCK_ERR = Device needs maintenance now</p> <p>Transducer_Error = General Error</p>	<p>OUT. QUALITY = UNCERTAIN</p> <p>OUT. SUBSTATUS = Non specific Error</p>	<p><i>Cause:</i> Advanced Diagnostics: The electrodynamic sensor is outside the limit value, set in the corresponding diagnosis function.</p>
806	<p><i>Device status message (FF):</i> Frequency fluctuation deviation limit – Err. No. 806</p> <p><i>Local display:</i> S: F. FLUCT. DEV. LIM. ‡: # 806</p>	<p>BLOCK_ERR = Device needs maintenance now</p> <p>Transducer_Error = General Error</p>	<p>OUT. QUALITY = UNCERTAIN</p> <p>OUT. SUBSTATUS = Non specific Error</p>	<p><i>Cause:</i> Advanced Diagnostics: The fluctuation of the operating frequency is outside the limit value set in the corresponding diagnosis functions.</p>
807	<p><i>Device status message (FF):</i> Tube damping fluctuation deviation limit – Err. No. 807</p> <p><i>Local display:</i> S: TD FLUCT. DEV. LIM. ‡: # 807</p>	<p>BLOCK_ERR = Device needs maintenance now</p> <p>Transducer_Error = General Error</p>	<p>OUT. QUALITY = UNCERTAIN</p> <p>OUT. SUBSTATUS = Non specific Error</p>	<p><i>Cause:</i> Advanced Diagnostics: The fluctuation of the tube damping is outside the limit value set in the corresponding diagnosis functions.</p>

9.2.2 List of process error messages

No.	Error messages: FOUNDATION Fieldbus (FF)* (Local display)	Transducer Block error messages	Analog Input Function Block error messages	Cause/remedy (Spare parts → 90)
<p>* With FOUNDATION Fieldbus, error messages are displayed in the "Diagnosis" Transducer Block (base index: 1600) by means of the "Diag. – Act.Sys.Condition" parameter (manufacturer-specific).</p> <p>P = Process error ‡ = Fault message (with an effect on operation) ! = Notice message (without any effect on operation)</p>				
No. # 5xx → Application error				
586	<i>Device status message (FF):</i> No fluid continuation – Err. No. 586 <i>Local display:</i> P: OSC. AMP. LIMIT ‡: # 586	BLOCK_ERR = Device needs maintenance now	OUT. QUALITY = BAD	<i>Cause:</i> The fluid properties do not allow a continuation of the measurement. <i>Causes:</i> – Extremely high viscosity – Process fluid is very inhomogeneous (gas or solid content) <i>Remedy:</i> Change or improve process conditions.
		Transducer_Error = Mechanical failure	OUT. SUBSTATUS = Sensor Failure	
			BLOCK_ERR = Input Failure (faulty input value from Transducer Blocks)	
587	<i>Device status message (FF):</i> Extreme process conditions – Err. No. 587 <i>Local display:</i> P: TUBE OSC. NOT ‡: # 587	BLOCK_ERR = Device needs maintenance now	OUT. QUALITY = BAD	<i>Cause:</i> Extreme process conditions exist. The measuring system can therefore not be started. <i>Remedy:</i> Change or improve process conditions.
		Transducer_Error = Mechanical failure	OUT. SUBSTATUS = Sensor Failure	
			BLOCK_ERR = Input Failure (faulty input value from Transducer Blocks)	
588	<i>Device status message (FF):</i> Overdriving of the analog/digital converter – Err. No. 588 <i>Local display:</i> P: GAIN RED.IMPOS ‡: # 588	BLOCK_ERR = Device needs maintenance now	OUT. QUALITY = BAD	<i>Cause:</i> Overdriving of the internal analog to digital converter. <i>Causes:</i> – Cavitation – Extreme pressure pulses – High gas flow velocity A continuation of the measurement is no longer possible! <i>Remedy:</i> Change or improve process conditions, e.g. by reducing the flow velocity.
		Transducer_Error = Mechanical failure	OUT. SUBSTATUS = Sensor Failure	
			BLOCK_ERR = Input Failure (faulty input value from Transducer Blocks)	
No. # 7xx → Application error				
700	<i>Device status message (FF):</i> Empty pipe detected – Err. No. 700 <i>Local display:</i> P: EMPTY PIPE DET. !: # 700		OUT. QUALITY = UNCERTAIN	<i>Cause:</i> The fluid density is outside the upper or lower limit values set for the empty pipe detection (EPD). <i>Causes:</i> – Air in the measuring tube – Partly filled measuring tube <i>Remedy:</i> 1. Ensure that there is no gas content in the process liquid. 2. Adapt the upper and lower limit values for empty pipe detection to the current process conditions. – FF: "Flow" Transducer Block (base index: 1400) → "EPD - Low Value" or "EPD - High Value" parameter – Local display: BASIC FUNCTIONS → PROCESSPARAMETER → EPD PARAMETER → EPD VALUE LOW or EPD VALUE HIGH
			OUT. SUBSTATUS = Non specific	

No.	Error messages: FOUNDATION Fieldbus (FF)* (Local display)	Transducer Block error messages	Analog Input Function Block error messages	Cause/remedy (Spare parts →  90)
701	<p><i>Device status message (FF):</i> Current of the measuring tube too high – Err. No. 701</p> <p><i>Local display:</i> P: EXC. CURR. LIM !: # 701</p>		<p>OUT. QUALITY = UNCERTAIN</p> <p>OUT. SUBSTATUS = Non specific</p>	<p><i>Cause:</i> The maximum current value for the measuring tube exciter coils has been reached, since certain process fluid characteristics are extreme, e.g. high gas or solid content. The instrument continues to work correctly.</p> <p><i>Remedy:</i> In particular with outgassing fluids and/or increased gas content, the following measures are recommended to increase system pressure:</p> <ol style="list-style-type: none"> 1. Install the instrument at the outlet side of a pump. 2. Install the instrument at the lowest point of an ascending pipeline. 3. Install a valve or orifice plate downstream from the instrument.
702	<p><i>Device status message (FF):</i> Frequency control not stable due to process fluid – Err. No. 702</p> <p><i>Local display:</i> P: FLUID INHOM. !: # 702</p>		<p>OUT. QUALITY = UNCERTAIN</p> <p>OUT. SUBSTATUS = Non specific</p>	<p><i>Cause:</i> Frequency control is not stable, due to inhomogeneous process fluid, e.g. gas or solid content.</p> <p><i>Remedy:</i> In particular with outgassing fluids and/or increased gas content, the following measures are recommended to increase system pressure:</p> <ol style="list-style-type: none"> 1. Install the instrument at the outlet side of a pump. 2. Install the instrument at the lowest point of an ascending pipeline. 3. Install a valve or orifice plate downstream from the instrument.
703	<p><i>Device status message (FF):</i> Overdriving of the control level – Err. No. 703</p> <p><i>Local display:</i> P: NOISE LIM. CH0 !: # 703</p>		<p>OUT. QUALITY = UNCERTAIN</p> <p>OUT. SUBSTATUS = Non specific</p>	<p><i>Cause:</i> Overdriving of the internal analog to digital converter.</p> <p><i>Causes:</i></p> <ul style="list-style-type: none"> – Cavitation – Extreme pressure pulses – High gas flow velocity
704	<p><i>Device status message (FF):</i> Overdriving of the control level – Err. No. 704</p> <p><i>Local display:</i> P: NOISE LIM. CH1 !: # 704</p>		<p>OUT. QUALITY = UNCERTAIN</p> <p>OUT. SUBSTATUS = Non specific</p>	<p>A continuation of the measurement is still possible!</p> <p><i>Remedy:</i> Change or improve process conditions, e.g. by reducing the flow velocity.</p>
705	<p><i>Device status message (FF):</i> Massflow too high – Err. No. 705</p> <p><i>Local display:</i> P: FLOW LIMIT !: # 705</p>		<p>OUT. QUALITY = BAD</p> <p>OUT. SUBSTATUS = Non specific</p>	<p><i>Cause:</i> The mass flow is too high. The electronics' measuring range will be exceeded.</p> <p><i>Remedy:</i> Reduce flow</p>
731	<p><i>Device status message (FF):</i> Zero point adjustment is not possible – Err. No. 731</p> <p><i>Local display:</i> P: ADJ. ZERO FAIL !: # 731</p>		<p>OUT. QUALITY = BAD</p> <p>OUT. SUBSTATUS = Non specific</p>	<p><i>Cause:</i> The zero point adjustment is not possible or has been canceled.</p> <p><i>Remedy:</i> Make sure that zero point adjustment is carried out at "zero flow" only ($v = 0$ m/s). →  64</p>

9.3 Process errors without messages

Symptoms	Rectification
 Note! You may have to change or correct certain settings of the function matrix in order to rectify faults. The functions outlined below are described in detail in the "Description of Device Functions" manual.	
Measured value reading fluctuates even though flow is steady.	<ol style="list-style-type: none"> 1. Check the fluid for presence of gas bubbles. 2. Increase the following values: <ul style="list-style-type: none"> – Analog Input Function Block → RISING TIME – BASIC FUNCTIONS → SYSTEM PARAMETER → CONFIGURATION → FLOW DAMPING 3. Increase the value for display damping: <ul style="list-style-type: none"> HOME → USER INTERFACE → CONTROL → BASIC CONFIGURATION → DISPLAY DAMPING
Measured value reading shown on display, even though the fluid is at a standstill and the measuring tube is full.	<ol style="list-style-type: none"> 1. Check the fluid for presence of gas bubbles. 2. Enter or increase the value for the switching point of low flow cut off: <ul style="list-style-type: none"> BASIC FUNCTIONS → PROCESSPARAMETER → CONFIGURATION → ON-VAL. LF CUTOFF
The fault cannot be rectified or some other fault not described above has occurred. In instances of this nature, contact your E+H service organization.	The following options are available for tackling problems of this nature: Request the services of an E+H service technician If you contact our service organization to have a service technician sent out, please be ready with the following information: <ul style="list-style-type: none"> ■ Brief description of the fault ■ Nameplate specifications: order code and serial number →  7 Return devices to E+H You return a measuring device to Endress+Hauser for calibration or repair. Always enclose a duly completed "Declaration of contamination" form with the flowmeter. You will find a preprinted form at the back of this manual. Replace transmitter electronics Components in the measuring electronics defective → Order spare part →  90

9.4 Spare parts

The previous sections contain a detailed troubleshooting guide → 75.

The measuring device, moreover, provides additional support in the form of continuous self-diagnosis and error messages.

Fault rectification can entail replacing defective components with tested spare parts. The illustration below shows the available scope of spare parts.



Note!

You can order spare parts directly from your Endress+Hauser service organization by providing the serial number printed on the transmitter's nameplate → 7.

Spare parts are shipped as sets comprising the following parts:

- Spare part
- Additional parts, small items (threaded fasteners, etc.)
- Mounting instructions
- Packaging

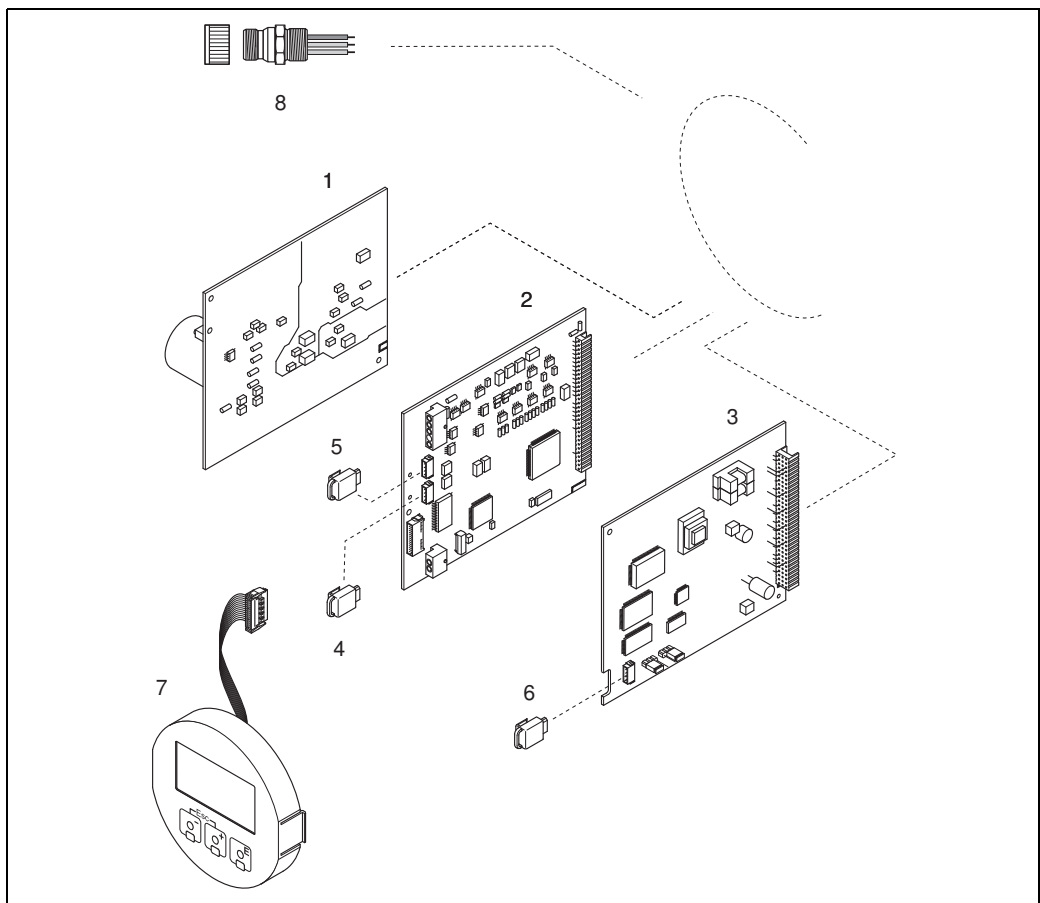

Fig. 36: Spare parts for transmitter (field and wall-mount housings)

- 1 Power unit board (85 to 260 V AC, 20 to 55 V AC, 16 to 62 V DC)
- 2 Amplifier board
- 3 I/O board FOUNDATION Fieldbus (COM module)
- 4 S-DAT (sensor data memory)
- 5 T-DAT (transmitter data memory)
- 6 F-CHIP (function chip for optional software)
- 7 Display module
- 8 Fieldbus connector consisting of: protection cap and connector

9.5 Removing and installing electronics boards

9.5.1 Field housing



Warning!

- Risk of electric shock. Exposed components carry dangerous voltages. Make sure that the power supply is switched off before you remove the cover of the electronics compartment.
- Risk of damaging electronic components (ESD protection). Static electricity can damage electronic components or impair their operability. Use a workplace with a grounded working surface purposely built for electrostatically sensitive devices!
- If you cannot guarantee that the dielectric strength of the device is maintained in the following steps, then an appropriate inspection must be carried out in accordance with the manufacturer's specifications.



Caution!

Use only original Endress+Hauser parts.

→  37, installation and removal:

1. Unscrew cover of the electronics compartment from the transmitter housing.
2. Remove the local display (1) as follows:
 - Press in the latches (1.1) at the side and remove the display module.
 - Disconnect the ribbon cable (1.2) of the display module from the amplifier board.
3. Remove the screws and remove the cover (2) from the electronics compartment.
4. Remove power unit board (4) and I/O board (6):
Insert a thin pin into the hole (3) provided for the purpose and pull the board clear of its holder.
5. Remove amplifier board (5):
 - Disconnect the connector of the signal cable (5.1) including S-DAT (5.3) from the board.
 - Gently disconnect the connector of the excitation current cable (5.2) from the board, i.e. without moving it back and forward.
 - Insert a thin pin into the hole (3) provided for the purpose and pull the board clear of its holder.
6. Installation is the reverse of the removal procedure.

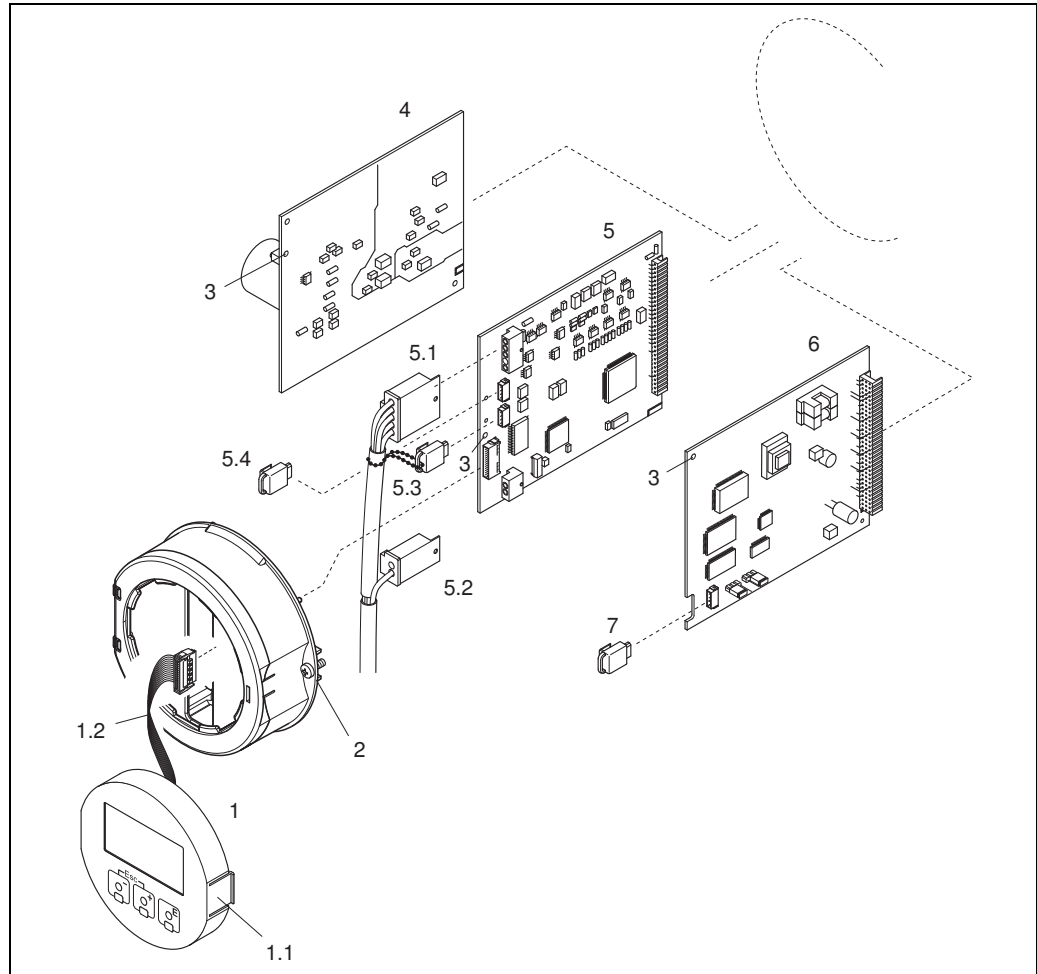

40004743

Fig. 37: Field housing: removing and installing electronics boards

- 1 Local display
- 1.1 Latch
- 1.2 Ribbon cable (display module)
- 2 Screws of electronics compartment cover
- 3 Aperture for installing/removing boards
- 4 Power unit board
- 5 Amplifier board
- 5.1 Signal cable (sensor)
- 5.2 Excitation current cable (sensor)
- 5.3 S-DAT (sensor data memory)
- 5.4 T-DAT (transmitter data memory)
- 6 I/O board (FOUNDATION Fieldbus type)
- 7 F-CHIP (function chip for optional software)

9.5.2 Wall-mount housing



Warning!

- Risk of electric shock. Exposed components carry dangerous voltages. Make sure that the power supply is switched off before you remove the cover of the electronics compartment.
- Risk of damaging electronic components (ESD protection). Static electricity can damage electronic components or impair their operability. Use a workplace with a grounded working surface purposely built for electrostatically sensitive devices!
- If you cannot guarantee that the dielectric strength of the device is maintained in the following steps, then an appropriate inspection must be carried out in accordance with the manufacturer's specifications.



Caution!

Use only original Endress+Hauser parts.

→  38, installation and removal:

1. Remove the screws and open the hinged cover (1) of the housing.
2. Remove the screws securing the electronics module (2). Then push up electronics module and pull it as far as possible out of the wall-mount housing.
3. Disconnect the following cable connectors from amplifier board (7):
 - Signal cable connector (7.1) including S-DAT (7.3)
 - Connector of exciting current cable (7.2):
Gently disconnect the connector, i.e. without moving it back and forward.
 - Ribbon-cable connector (3) of the display module
4. Remove the cover (4) from the electronics compartment by loosening the screws.
5. Removing boards (6, 7, 8):
Insert a thin pin into the hole (5) provided for the purpose and pull the board clear of its holder.
6. Installation is the reverse of the removal procedure.

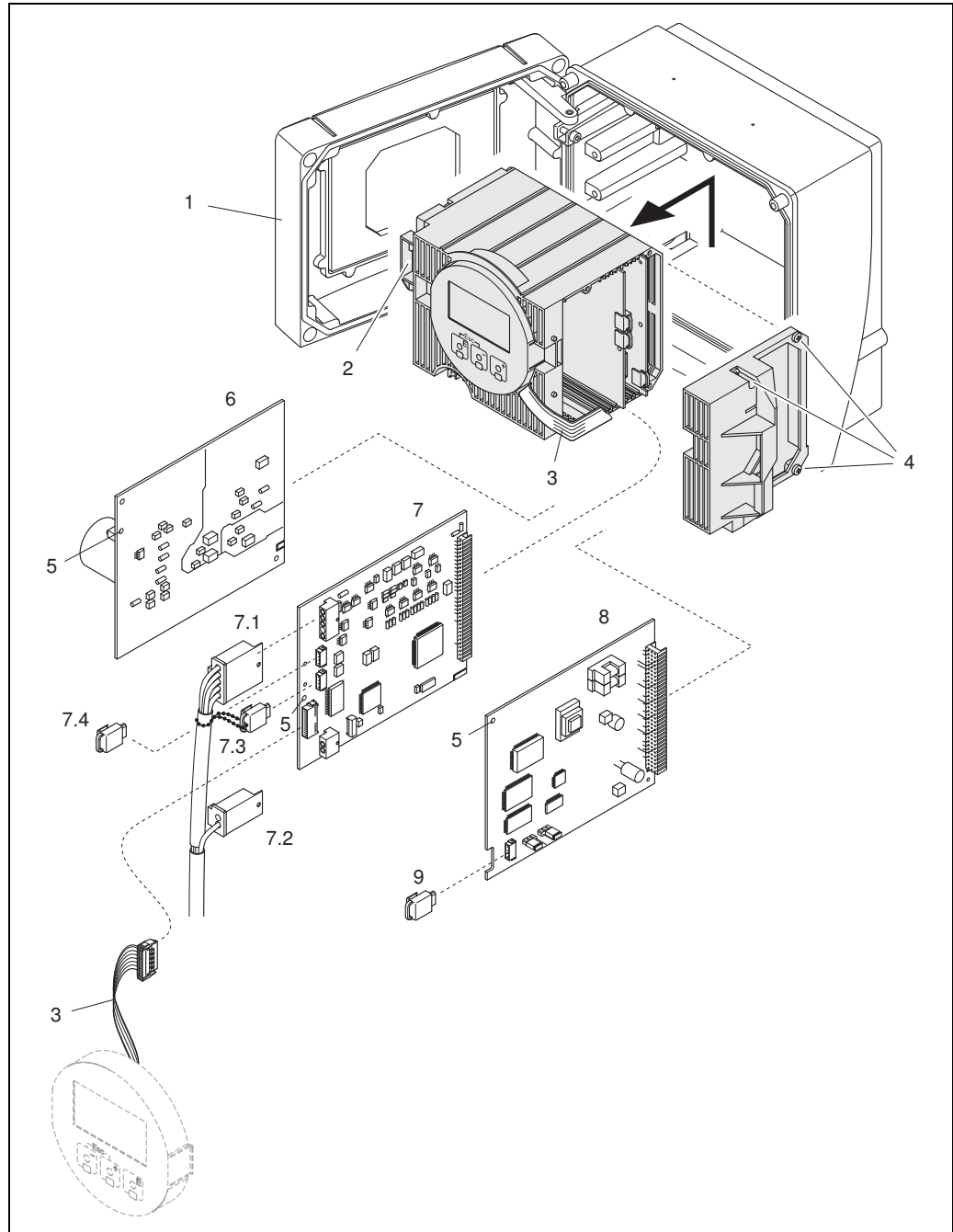

Fig. 38: Wall-mount housing: removing and installing electronics boards

- 1 Housing cover
- 2 Electronics module
- 3 Ribbon cable (display module)
- 4 Screws of electronics compartment cover
- 5 Aperture for installing/removing boards
- 6 Power unit board
- 7 Amplifier board
- 7.1 Signal cable (sensor)
- 7.2 Excitation current cable (sensor)
- 7.3 S-DAT (sensor data memory)
- 7.4 T-DAT (transmitter data memory)
- 8 I/O board (FOUNDATION Fieldbus type)
- 9 F-CHIP (function chip for optional software)

9.6 Replacing the device fuse



Warning!

Risk of electric shock. Exposed components carry dangerous voltages. Make sure that the power supply is switched off before you remove the cover of the electronics compartment.

The main fuse is on the power unit board → 39.

The procedure for replacing the fuse is as follows:

1. Switch off power supply.
2. Remove power unit board → 91
3. Remove cap (1) and replace the device fuse (2).
Use only fuses of the following type:
 - Power supply 20 to 55 V AC / 16 to 62 V DC → 2.0 A slow-blow / 250 V; 5.2 × 20 mm
 - Power supply 85 to 260 V AC → 0.8 A slow-blow / 250 V; 5.2 × 20 mm
 - Ex-rated devices → see the Ex documentation.
4. Installation is the reverse of the removal procedure.



Caution!

Use only original Endress+Hauser parts.

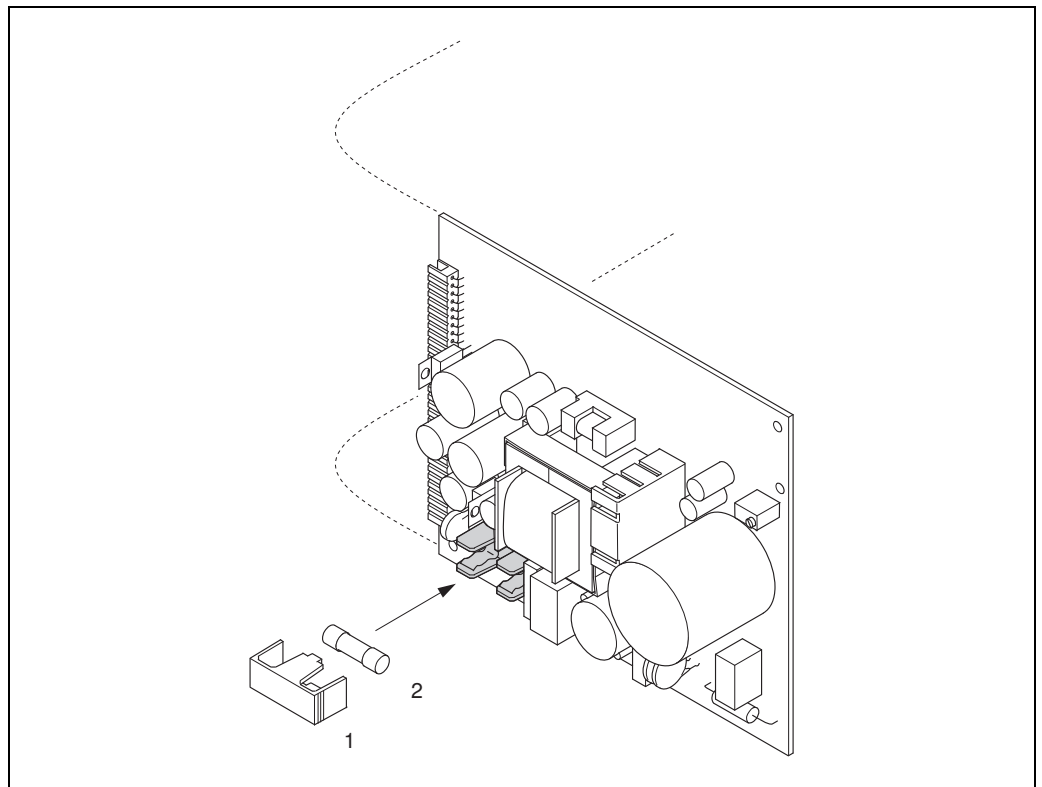

Fig. 39: Replacing the device fuse on the power unit board

- 1 Protective cap
2 Device fuse

9.7 Return



Caution!

Do not return a measuring device if you are not absolutely certain that all traces of hazardous substances have been removed, e.g. substances which have penetrated crevices or diffused through plastic.

Costs incurred for waste disposal and injury (burns, etc.) due to inadequate cleaning will be charged to the owner-operator.

The following steps must be taken before returning a flow measuring device to Endress+Hauser, e.g. for repair or calibration:

- Always enclose a duly completed "Declaration of contamination" form. Only then can Endress+Hauser transport, examine and repair a returned device.
- Enclose special handling instructions if necessary, for example a safety data sheet as per EC REACH Regulation No. 1907/2006.
- Remove all residues. Pay special attention to the grooves for seals and crevices which could contain residues. This is particularly important if the substance is hazardous to health, e.g. flammable, toxic, caustic, carcinogenic, etc.



Note!

You will find a preprinted "Declaration of contamination" form at the back of these Operating Instructions.

9.8 Disposal

Observe the regulations applicable in your country!

9.9 Software history

Date	Software version	Software modifications	Documentation
10.2012	3.00.XX	–	71197486/14.12
09.2011	3.00.XX	New sensors: Promass O and Promass X	71141445/13.11
06.2010		–	71116477/06.10
10.2009	3.00.XX	Introduction of new FOUNDATION Fieldbus I/O board Shorter execution times: – Analog Input Function Blocks 1 to 8 (each 18 ms) – PID Function Block (25 ms) – Discrete Output Function Block (18 ms) – Integrator Function Block (18 ms) Software adaptations: – ITK Version: 5.01	71089885/07.09
01.2007	2.00.XX	New sensors: Promass P and Promass S Shorter execution times: – Analog Input Function Blocks 1 to 8 (20 ms) – Discrete Output Function Block (20 ms) – PID Function Block (50 ms) New Function Blocks: – Arithmetic Function Block (20 ms) – Input Selector Function Block (20 ms) – Signal Characterizer Function Block (20 ms) – Integrator Function Block (25 ms) New Transducer Blocks: – Advanced Diagnostics – Viscosity – Calculated Density Method: – Commissioning – Gas measurement Software adaptations: – ITK Version: 5.01 – CFF version 1.7	71035080/12.06
11.2005	1.01.XX	Software expansion – Promass I DN80, DN50FB – General instrument functions	71008409/12.05
11.2004	1.01.XX	Software expansion – New sensor DN 250 – Chinese language package (English and Chinese contents) New functionalities: – Empty pipe detection via exciting current (EPD EXC.CURR. (6426)) – DEVICE SOFTWARE (8100) → Device software displayed (NAMUR recommendation 53)	

Date	Software version	Software modifications	Documentation
10.2003	Amplifier: 1.06.XX	Software expansion: – Language group – Adjustments to Fieldcheck and Simubox New functionalities: – Operation hours counter – Intensity of background illumination adjustable – Counter for access code Compatible with: – ToF-Tool FieldTool Package (the latest SW version can be downloaded under: www.tof-fieldtool.endress.com) – Upload and download via ToF Tool - Fieldtool package	50098622/05.04
03.2003	Amplifier: 1.05.XX	Software adjustment	
08.2002	Amplifier: 1.04.XX	Software expansion: Promass E	50098622/01.03
04.2002	Amplifier: 1.02.02	Software expansion: Promass H	50098622/04.02
03.2002	Communication module: 1.01.00	Software adjustments: FOUNDATION Fieldbus software merged (Prosonic Flow 93, Promag 53, Promass 83) – Device Revision 2, DD Revision 1 – Certification No. IT 014800 – ITK 4.0 – CFF version 1.5	
11.2001	Amplifier: 1.02.01	Software adjustment	
06.2001	Amplifier: 1.02.00	Software expansion: General device functions New functionalities: (not relevant for FOUNDATION Fieldbus)	
05.2001	Amplifier: 1.01.01	Software adjustment	
03.2001	Amplifier: 1.01.00		
12.2000	Communication module: 1.00.01	Original software – Device Revision 1, DD Revision 1 – Certification No. IT 009600 – ITK 4.0 – CFF version 1.5	50098622/12.00
11.2000	Amplifier: 1.00.XX	Original software	

10 Technical data

10.1 Technical data at a glance

10.1.1 Applications

→ 5

10.1.2 Function and system design

Measuring principle Mass flow measurement by the Coriolis principle

Measuring system → 7

10.1.3 Input

Measured variable

- Mass flow (proportional to the phase difference between two sensors mounted on the measuring tube to register a phase shift in the oscillation)
- Fluid density (proportional to resonance frequency of the measuring tube)
- Fluid temperature (measured with temperature sensors)

Measuring range *Measuring ranges for liquids*

DN		Range for full scale values (liquids) $\dot{m}_{\min(F)}$ to $\dot{m}_{\max(F)}$	
[mm]	[inch]		
1	1/24	0 to 20 kg/h	0 to 0.7 lb/min
2	1/12	0 to 100 kg/h	0 to 3.7 lb/min
4	1/8	0 to 450 kg/h	0 to 16.5 lb/min
8	3/8	0 to 2000 kg/h	0 to 73.5 lb/min
15	½	0 to 6500 kg/h	0 to 238 lb/min
15 FB	½ FB	0 to 18000 kg/h	0 to 660 lb/min
25	1	0 to 18000 kg/h	0 to 660 lb/min
25 FB	1 FB	0 to 45000 kg/h	0 to 1650 lb/min
40	1 ½	0 to 45000 kg/h	0 to 1650 lb/min
40 FB	1 ½ FB	0 to 70000 kg/h	0 to 2570 lb/min
50	2	0 to 70000 kg/h	0 to 2570 lb/min
50 FB	2 FB	0 to 180000 kg/h	0 to 6600 lb/min
80	3	0 to 180000 kg/h	0 to 6600 lb/min
100	4	0 to 350000 kg/h	0 to 12860 lb/min
150	6	0 to 800000 kg/h	0 to 29400 lb/min
250	10	0 to 2200000 kg/h	0 to 80860 lb/min
350	14	0 to 4100 t/h	0 to 4520 tn. sh./h

FB = Full bore versions of Promass I

Measuring ranges for gases, general, (except Promass H (Zr))

The full scale values depend on the density of the gas. Use the formula below to calculate the full scale values:

$$\dot{m}_{\max(G)} = \dot{m}_{\max(F)} \cdot \rho_{(G)} : x \text{ [kg/m}^3 \text{ (lb/ft}^3\text{)]}$$

$\dot{m}_{\max(G)}$ = Max. full scale value for gas [kg/h (lb/min)]

$\dot{m}_{\max(F)}$ = Max. full scale value for liquid [kg/h (lb/min)]

$\rho_{(G)}$ = Gas density in [kg/m³ (lb/ft³)] for process conditions

Here, $\dot{m}_{\max(G)}$ can never be greater than $\dot{m}_{\max(F)}$

Measuring ranges for gases (Promass F, O):

DN		x
[mm]	[inch]	
8	3/8	60
15	1/2	80
25	1	90
40	1 1/2	90
50	2	90
80	3	110
100	4	130
150	6	200
250	10	200

Measuring ranges for gases (Promass E)

DN		x
[mm]	[inch]	
8	3/8	85
15	1/2	110
25	1	125
40	1 1/2	125
50	2	125
80	3	155

Measuring ranges for gases (Promass P, S, H (Ta))

DN		x
[mm]	[inch]	
8	3/8	60
15	1/2	80
25	1	90
40 ¹⁾	1 1/2 ¹⁾	90
50 ¹⁾	2 ¹⁾	90

¹⁾ only Promass P, S

Measuring ranges for gases (Promass A)

DN		x
[mm]	[inch]	
1	1/24	32
2	1/12	32
4	1/8	32

Measuring ranges for gases (Promass I)

DN		x
[mm]	[inch]	
8	3/8	60
15	1/2	80
15 FB	1/2 FB	90
25	1	90
25 FB	1 FB	90
40	1 1/2	90
40 FB	1 1/2 FB	90
50	2	90
50 FB	2 FB	110
80	3	110

FB = Full bore versions of Promass I

Measuring ranges for gases (Promass X)

DN		x
[mm]	[inch]	
350	14	200

Calculation example for gas:

- Sensor type: Promass F, DN 50
- Gas: air with a density of 60.3 kg/m³ (at 20 °C and 50 bar)
- Measuring range (liquid): 70 000 kg/h
- x = 90 (for Promass F DN 50)

Max. possible full scale value:

$$\dot{m}_{\max(G)} = \dot{m}_{\max(F)} \cdot \rho_{(G)} \div x \text{ [kg/m}^3\text{]} = 70\,000 \text{ kg/h} \cdot 60.3 \text{ kg/m}^3 \div 90 \text{ kg/m}^3 = 46\,900 \text{ kg/h}$$

Recommended full scale values

See → Page 127 ff. ("Limiting flow")

Operable flow range

Greater than 1000 : 1. Flows above the preset full scale value do not overload the amplifier, i.e. totalizer values are registered correctly.

10.1.4 Output

Output signal	<i>Physical data transmission (Physical Layer Type):</i> <ul style="list-style-type: none"> ■ Fieldbus interface in accordance with IEC 61158-2 ■ Corresponds to device version type 512 of the FOUNDATION Fieldbus specification: <ul style="list-style-type: none"> type 512 – standard data transfer (± 9 mA, symmetrical), separate supply to field device (4-wire), intrinsically safe version of the FF interface, FISCO ■ With integrated reverse polarity protection
Signal on alarm	Status messages as per FOUNDATION Fieldbus specification
Link Master (LM) support	Yes
Link Master	Selectable
Basic Device	Factory setting
Device basic current	12 mA
Device starting current	<12 mA
Device error current (FDE)	0 mA
Device (lift off) min. voltage	9 V (H1-segment)
Permissible fieldbus supply voltage	9 to 32 V
Integrated reverse polarity protection	Yes
ITK Version	5.01
Number of VCRs (total)	38
Number of link objects in VFD	40
Device capacitance	In accordance with IEC 60079-27, FISCO/FNICO
Galvanic isolation	All circuits for inputs, outputs and power supply are galvanically isolated from each other.
Data transmission rate	31.25 kbit/s, voltage mode
Signal coding	Manchester II

Bus times

Min. idle time between two telegrams:

MIN_INTER_PDU_DELAY = 6 octet time (transfer time per octet)

Block information,
execution time

Block	Base index	Execution time [ms]	Functionality
Resource Block	400	–	Enhanced
"Flow" Transducer Block	1400	–	Vendor specific
"Diagnosis" Transducer Block	1600	–	Vendor specific
"Display" Transducer Block	1800	–	Vendor specific
"Totalizer" Transducer Block	1900	–	Vendor specific
"Calculated Density" Transducer Block	2000	–	Vendor specific
"Viscosity" Transducer Block	2100	–	Vendor specific
"Advanced Diagnostics" Transducer Block	2200	–	Vendor specific
Analog Input Function Block 1	500	18	Standard
Analog Input Function Block 2	550	18	Standard
Analog Input Function Block 3	600	18	Standard
Analog Input Function Block 4	650	18	Standard
Analog Input Function Block 5	700	18	Standard
Analog Input Function Block 6	750	18	Standard
Analog Input Function Block 7	800	18	Standard
Analog Input Function Block 8	850	18	Standard
Discrete Output Function Block (DO)	900	18	Standard
PID Function Block (PID)	1000	25	Standard
Arithmetic Function Block (ARTH)	1100	20	Standard
Input Selector Function Block (ISEL)	1150	20	Standard
Signal Characterizer Function Block (CHAR)	1200	20	Standard
Integrator Function Block (INTG)	1250	18	Standard

Output data

Transducer Blocks / Analog Input Function Blocks

Block	Process variable	Channel parameter (AI Block)
"Flow" Transducer Block	Mass flow	1
	Volume flow	2
	Corrected volume flow	3
	Density	4
	Reference density	5
	Temperature	6
"Totalizer" Transducer Block	Totalizer 1	7
	Totalizer 2	8
	Totalizer 3	9
The following measured variables are available if the "Concentration measurement" add-on is installed in the measuring device (order option)		
"Concentration" Transducer Block	Target fluid mass flow	40
	Target fluid % mass	41
	Target fluid volume flow	42
	Target fluid % volume	43
	Target fluid corrected volume flow	44
	Carrier fluid mass flow	45
	Carrier fluid % mass	46
	Carrier fluid volume flow	47
	Carrier fluid % volume	48
	Carrier fluid corrected volume flow	49
	% Black liquor	41
	°Baume	50
	°API	
	°Plato	
°Balling		
°Brix		
Flexible		
The following measured variables are available if the "Viscosity" add-on is installed in the measuring device (order option)		
"Viscosity" Transducer Block	Dynamic viscosity	90
	Kinematic viscosity	91
	Temperature-compensated dynamic viscosity	92
	Temperature-compensated kinematic viscosity	93
The following measured variables are available if the "Advanced diagnostics" add-on is installed in the measuring device (order option)		
"Advanced Diagnostics" Transducer Block	Mass flow deviation	70
	Density deviation	71
	Reference density deviation	72
	Temperature deviation	73
	Tube damping deviation	74
	Electrodynamic sensor deviation	75
	Deviation of operating frequency fluctuation	76
	Deviation of tube damping fluctuation	77

Input data

Discrete Output Function Block (channel 16)

Status change	Action
Discrete state 0 → Discrete state 1	reserved
Discrete state 0 → Discrete state 2	Positive zero return ON
Discrete state 0 → Discrete state 3	Positive zero return OFF
Discrete state 0 → Discrete state 4	Zero point adjustment
Discrete state 0 → Discrete state 5	reserved
Discrete state 0 → Discrete state 6	reserved
Discrete state 0 → Discrete state 7	Reset Totalizer 1, 2, 3
Discrete state 0 → Discrete state 8	Reset Totalizer 1
Discrete state 0 → Discrete state 9	Reset Totalizer 2
Discrete state 0 → Discrete state 10	Reset Totalizer 3
Discrete state 0 → Discrete state 27	Permanent storage: Off
Discrete state 0 → Discrete state 28	Permanent storage: On
The following measured variables are available if the "Concentration measurement" add-on is installed in the measuring device (order option)	
Discrete state 0 → Discrete state 60	Select concentration specification 1
Discrete state 0 → Discrete state 61	Select concentration specification 2
Discrete state 0 → Discrete state 62	Select concentration specification 3
Discrete state 0 → Discrete state 63	Select concentration specification 4
The following measured variables are available if the "Advanced diagnostics" add-on is installed in the measuring device (order option)	
Discrete state 0 → Discrete state 25	Warning mode: OFF
Discrete state 0 → Discrete state 26	Warning mode: ON
Discrete state 0 → Discrete state 70	Start determining user reference status
Discrete state 0 → Discrete state 71	reserved
Discrete state 0 → Discrete state 72	reserved
Discrete state 0 → Discrete state 73	reserved
Discrete state 0 → Discrete state 74	Acquisition mode: Off
Discrete state 0 → Discrete state 75	Acquisition mode: Periodic
Discrete state 0 → Discrete state 76	Acquisition mode: Manual
Discrete state 0 → Discrete state 77	Reset history
Discrete state 0 → Discrete state 78	Start manual determination of diag. parameter

VCRs

VCRs (total 48)	Quantity
Permanent Entries	1
Client VCRs	0
Server VCRs	24
Source VCRs	23
Sink VCRs	0
Subscriber VCRs	23
Publisher VCRs	23

10.1.5 Power supply

Electrical connections →  26

Supply voltage 85 to 260 V AC, 45 to 65 Hz
20 to 55 V AC, 45 to 65 Hz
16 to 62 V DC

Cable entries *Power supply and signal cables (inputs/outputs):*

- Cable entry M20 × 1.5 (8 to 12 mm)
- Threads for cable entries, 1/2" NPT, G 1/2"

Connecting cable for remote version:

- Cable entry M20 × 1.5 (8 to 12 mm)
- Threads for cable entries, 1/2" NPT, G 1/2"

Cable specifications →  30
remote version

Power consumption AC: <15 VA (including sensor)
DC: <15 W (including sensor)

Switch-on current:

- max. 13.5 A (< 50 ms) at 24 V DC
- max. 3 A (< 5 ms) at 260 V AC

Power supply failure Lasting min. 1 power cycle:

- EEPROM and T-DAT save measuring system data if power supply fails.
- HistoROM/S-DAT: exchangeable data storage chip with sensor-specific data (nominal diameter, serial number, calibration factor, zero point, etc.)

Potential equalization No measures necessary.

10.1.6 Performance characteristics

Reference operating conditions

- Error limits following ISO/DIN 11631
- Water, typically +15 to +45 °C (+59 to +113 °F); 2 to 6 bar (29 to 87 psi)
- Data according to calibration protocol ±5 °C (±9 °F) and ±2 bar (±29 psi)
- Accuracy based on accredited calibration rigs according to ISO 17025

Performance characteristic Promass A

o.r. = of reading; 1 g/cm³ = 1 kg/l; T = medium temperature

Maximum measured error

The following values refer to the pulse/frequency output.
 The additional measured error at the current output is typically ±5 µA.
 Design fundamentals → 108.

- Mass flow and volume flow (liquids): ±0.10% o.r.
- Mass flow (gases): ±0.50% o.r.
- Density (liquids)
 - Reference conditions: ±0.0005 g/cm³
 - Field density calibration: ±0.0005 g/cm³
(valid after field density calibration under process conditions)
 - Standard density calibration: ±0.02 g/cm³
(valid over the entire temperature range and density range → 128)
 - Special density calibration: ±0.002 g/cm³
(optional, valid range: +5 to +80 °C (+41 to +176 °F) and 0.0 to 2.0 g/cm³)
- Temperature: ±0.5 °C ± 0.005 · T °C; ±1 °F ± 0.003 · (T - 32) °F

Zero point stability

DN		Max. full scale value		Zero point stability	
[mm]	[inch]	[kg/h] or [l/h]	[lb/min]	[kg/h] or [l/h]	[lb/min]
1	1/24	20	0.73	0.0010	0.000036
2	1/12	100	3.70	0.0050	0.00018
4	1/8	450	16.5	0.0225	0.0008

Example for max. measured error

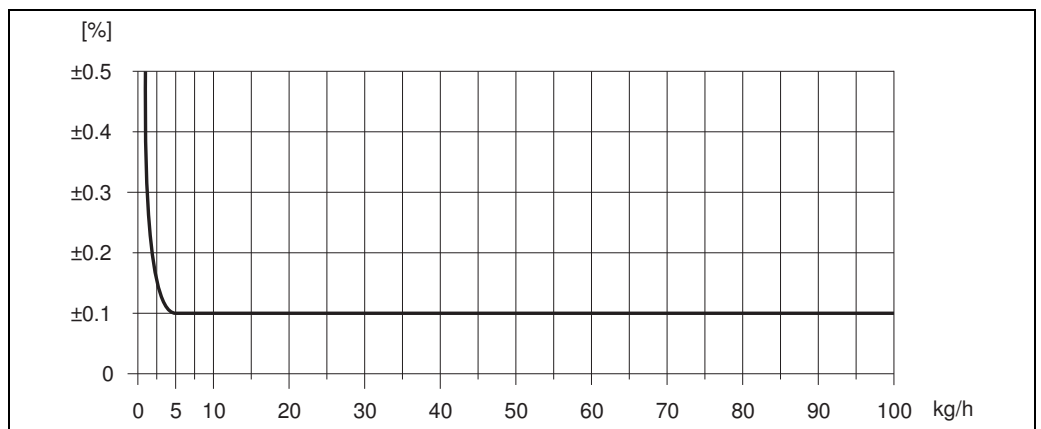

Fig. 40: Max. measured error in % o.r. (example: Promass A, DN 2)

Flow values (example)

Turn down	Flow		Max. measured error [% o.r.]
	[kg/h]	[lb/min.]	
250:1	0.4	0.0147	1.250
100:1	1.0	0.0368	0.500
25:1	4.0	0.1470	0.125
10:1	10	0.3675	0.100
2:1	50	1.8375	0.100

Design fundamentals → 108

Repeatability

Design fundamentals → 108

- Mass flow and volume flow (liquids): ±0.05% o.r.
- Mass flow (gases): ±0.25% o.r.
- Density (liquids): ±0.00025 g/cm³
- Temperature: ±0.25 °C ± 0.0025 · T °C; ±0.5 °F ± 0.0015 · (T - 32) °F

Influence of medium temperature

When there is a difference between the temperature for zero point adjustment and the process temperature, the typical measured error of the sensor is ±0.0002% of the full scale value / °C (±0.0001% of the full scale value/°F).

Influence of medium pressure

A difference in pressure between the calibration pressure and the process pressure does not have any effect on the accuracy.

Design fundamentals

Dependent on the flow:

- Flow ≥ Zero point stability ÷ (Base accuracy ÷ 100)
 - Max. measured error: ±Base accuracy in % o.r.
 - Repeatability: ± ½ · Base accuracy in % o.r.
- Flow < Zero point stability ÷ (Base accuracy ÷ 100)
 - Max. measured error: ± (Zero point stability ÷ measured value) · 100% o.r.
 - Repeatability: ± ½ · (Zero point stability ÷ measured value) · 100% o.r.

Base accuracy for	
Mass flow liquids	0.10
Volume flow liquids	0.10
Mass flow gases	0.50

Performance characteristic Promass E o.r. = of reading; $1 \text{ g/cm}^3 = 1 \text{ kg/l}$; T = medium temperature

Maximum measured error

The following values refer to the pulse/frequency output.
 The additional measured error at the current output is typically $\pm 5 \mu\text{A}$.
 Design fundamentals →  111.

- Mass flow and volume flow (liquids): $\pm 0.25\%$ o.r.
- Mass flow (gases): $\pm 0.75\%$ o.r.
- Density (liquids)
 - Reference conditions: $\pm 0.0005 \text{ g/cm}^3$
 - Field density calibration: $\pm 0.0005 \text{ g/cm}^3$
 (valid after field density calibration under process conditions)
 - Standard density calibration: $\pm 0.02 \text{ g/cm}^3$
 (valid over the entire temperature range and density range →  128)
- Temperature: $\pm 0.5 \text{ }^\circ\text{C} \pm 0.005 \cdot T \text{ }^\circ\text{C}$; $\pm 1 \text{ }^\circ\text{F} \pm 0.003 \cdot (T - 32) \text{ }^\circ\text{F}$

Zero point stability

DN		Zero point stability	
[mm]	[inch]	[kg/h] or [l/h]	[lb/min]
8	3/8	0.20	0.0074
15	1/2	0.65	0.0239
25	1	1.80	0.0662
40	1 1/2	4.50	0.1654
50	2	7.00	0.2573
80	3	18.00	0.6615

Example for max. measured error

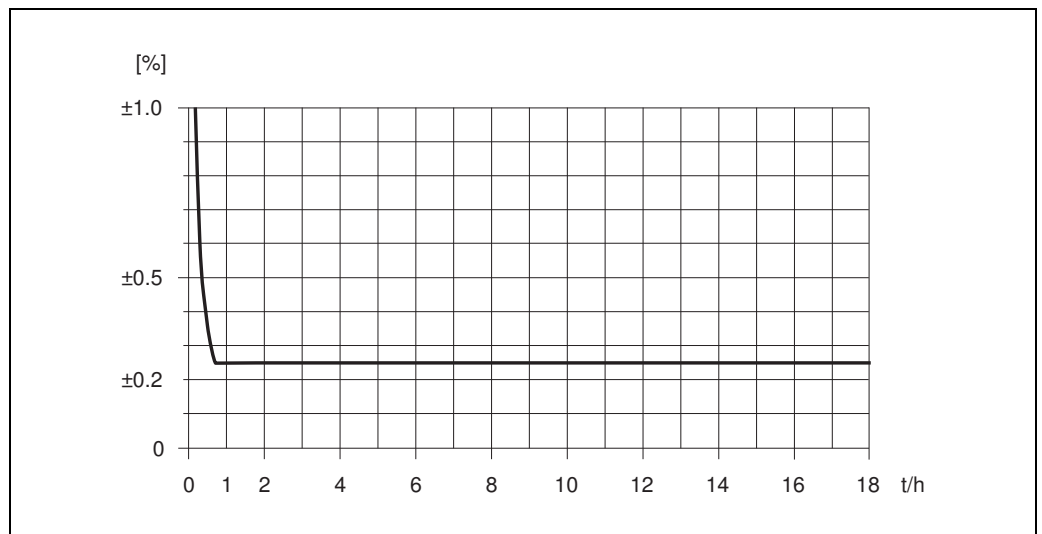

Fig. 41: Max. measured error in % o.r. (example: Promass E, DN 25)

Flow values (example)

Turn down	Flow		Maximum measured error [% o.r.]
	[kg/h]	[lb/min]	
250 : 1	72	2.646	2.50
100 : 1	180	6.615	1.00
25 : 1	720	26.46	0.25
10 : 1	1800	66.15	0.25
2 : 1	9000	330.75	0.25

Design fundamentals → 111

Repeatability

Design fundamentals → 111

- Mass flow and volume flow (liquids): ±0.10% o.r.
- Mass flow (gases): ±0.35% o.r.
- Density (liquids): ±0.00025 g/cm³
- Temperature: ±0.25 °C ± 0.0025 · T °C; ±0.5 °F ± 0.0015 · (T - 32) °F

Influence of medium temperature

When there is a difference between the temperature for zero point adjustment and the process temperature, the typical measured error of the sensor is ±0.0002% of the full scale value / °C (±0.0001% of the full scale value/°F).

Influence of medium pressure

The table below shows the effect on accuracy of mass flow due to a difference between calibration pressure and process pressure.

DN		[% o.r./bar]
[mm]	[inch]	
8	3/8	no influence
15	½	no influence
25	1	no influence
40	1½	no influence
50	2	-0.009
80	3	-0.020

Design fundamentals

Dependent on the flow:

- Flow \geq Zero point stability \div (Base accuracy \div 100)
 - Max. measured error: \pm Base accuracy in % o.r.
 - Repeatability: $\pm \frac{1}{2} \cdot$ Base accuracy in % o.r.
- Flow $<$ Zero point stability \div (Base accuracy \div 100)
 - Max. measured error: \pm (Zero point stability \div measured value) \cdot 100% o.r.
 - Repeatability: $\pm \frac{1}{2} \cdot$ (Zero point stability \div measured value) \cdot 100% o.r.

Base accuracy for	
Mass flow liquids	0.25
Volume flow liquids	0.25
Mass flow gases	0.75

Performance characteristic
Promass Fo.r. = of reading; $1 \text{ g/cm}^3 = 1 \text{ kg/l}$; T = medium temperature*Maximum measured error*

The following values refer to the pulse/frequency output.

The additional measured error at the current output is typically $\pm 5 \mu\text{A}$.Design fundamentals \rightarrow  113.

- Mass flow and volume flow (liquids):
 - $\pm 0.05\%$ o.r. (PremiumCal, for mass flow)
 - $\pm 0.10\%$ o.r.
- Mass flow (gases): $\pm 0.35\%$ o.r.
- Density (liquids)
 - Reference conditions: $\pm 0.0005 \text{ g/cm}^3$
 - Field density calibration: $\pm 0.0005 \text{ g/cm}^3$
(valid after field density calibration under process conditions)
 - Standard density calibration: $\pm 0.01 \text{ g/cm}^3$
(valid over the entire temperature range and density range \rightarrow  128)
 - Special density calibration: $\pm 0.001 \text{ g/cm}^3$
(optional, valid range: $+5$ to $+80 \text{ }^\circ\text{C}$ ($+41$ to $+176 \text{ }^\circ\text{F}$) and 0.0 to 2.0 g/cm^3)
- Temperature: $\pm 0.5 \text{ }^\circ\text{C} \pm 0.005 \cdot T \text{ }^\circ\text{C}$; $\pm 1 \text{ }^\circ\text{F} \pm 0.003 \cdot (T - 32) \text{ }^\circ\text{F}$

Zero point stability Promass F (standard)

DN		Zero point stability Promass F (Standard)	
[mm]	[inch]	[kg/h] or [l/h]	[lb/min]
8	3/8	0.030	0.001
15	1/2	0.200	0.007
25	1	0.540	0.019
40	1 1/2	2.25	0.083
50	2	3.50	0.129
80	3	9.00	0.330
100	4	14.00	0.514
150	6	32.00	1.17
250	10	88.00	3.23

Zero point stability Promass F (high-temperature version)

DN		Zero point stability Promass F (high-temperature version)	
[mm]	[inch]	[kg/h] or [l/h]	[lb/min]
25	1	1.80	0.0661
50	2	7.00	0.2572
80	3	18.0	0.6610

Example for max. measured error

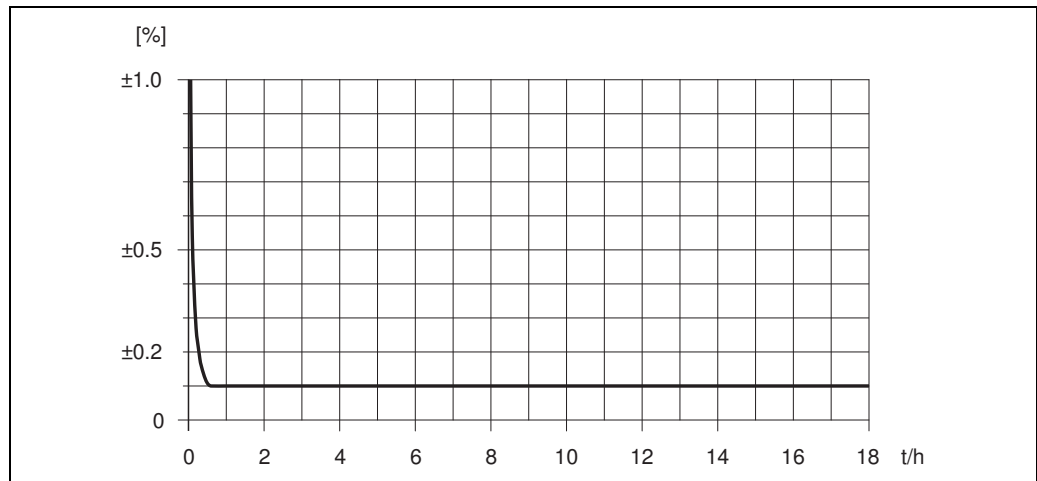

Fig. 42: Max. measured error in % o.r. (example: Promass F, DN 25)

Flow values (example)

Turn down	Flow		Maximum measured error [% o.r.]
	[kg/h]	[lb/min]	
500 : 1	36	1.323	1.5
100 : 1	180	6.615	0.3
25 : 1	720	26.46	0.1
10 : 1	1800	66.15	0.1
2 : 1	9000	330.75	0.1

Design fundamentals → 113

Repeatability

Design fundamentals → 113.

- Mass flow and volume flow (liquids):
 ±0.025% o.r. (PremiumCal, for mass flow)
 ±0.05% o.r.
- Mass flow (gases): ±0.25% o.r.
- Density (liquids): ±0.00025 g/cm³
- Temperature: ±0.25 °C ± 0.0025 · T °C; ±0.5 °F ± 0.0015 · (T - 32) °F

Influence of medium temperature

When there is a difference between the temperature for zero point adjustment and the process temperature, the typical measured error of the sensor is $\pm 0.0002\%$ of the full scale value / °C ($\pm 0.0001\%$ of the full scale value/°F).

Influence of medium pressure

The table below shows the effect on accuracy of mass flow due to a difference between calibration pressure and process pressure.

DN		Promass F (standard)	Promass F (high-temperature version)
[mm]	[inch]	[% o.r./bar]	[% o.r./bar]
8	3/8	no influence	–
15	1/2	no influence	–
25	1	no influence	no influence
40	1 1/2	–0.003	–
50	2	–0.008	–0.008
80	3	–0.009	–0.009
100	4	–0.007	–
150	6	–0.009	–
250	10	–0.009	–

Design fundamentals

Dependent on the flow:

- Flow \geq Zero point stability \div (Base accuracy \div 100)
 - Max. measured error: \pm Base accuracy in % o.r.
 - Repeatability: $\pm 1/2 \cdot$ Base accuracy in % o.r.
- Flow $<$ Zero point stability \div (Base accuracy \div 100)
 - Max. measured error: \pm (Zero point stability \div measured value) \cdot 100% o.r.
 - Repeatability: $\pm 1/2 \cdot$ (Zero point stability \div measured value) \cdot 100% o.r.

Base accuracy for	
Mass flow liquids, PremiumCal	0.05
Mass flow liquids	0.10
Volume flow liquids	0.10
Mass flow gases	0.35

Performance characteristic
Promass H

o.r. = of reading; $1 \text{ g/cm}^3 = 1 \text{ kg/l}$; T = medium temperature

Maximum measured error

The following values refer to the pulse/frequency output.
The additional measured error at the current output is typically $\pm 5 \mu\text{A}$.
Design fundamentals → 116.

- Mass flow and volume flow (liquids)
Zirconium 702/R 60702 and Tantalum 2.5W: $\pm 0.10\%$ o.r.
- Mass flow (gases)
Tantalum 2.5W: $\pm 0.50\%$ o.r.
- Density (liquids)
Zirconium 702/R 60702 and Tantalum 2.5W
 - Reference conditions: $\pm 0.0005 \text{ g/cm}^3$
 - Field density calibration: $\pm 0.0005 \text{ g/cm}^3$
(valid after field density calibration under process conditions)
 - Standard density calibration: $\pm 0.02 \text{ g/cm}^3$
(valid over the entire temperature range and density range → 128)
 - Special density calibration: $\pm 0.002 \text{ g/cm}^3$
(optional, valid range: $+10$ to $+80 \text{ }^\circ\text{C}$ ($+50$ to $+176 \text{ }^\circ\text{F}$) and 0.0 to 2.0 g/cm^3)
- Temperature: $\pm 0.5 \text{ }^\circ\text{C} \pm 0.005 \cdot T \text{ }^\circ\text{C}$; $\pm 1 \text{ }^\circ\text{F} \pm 0.003 \cdot (T - 32) \text{ }^\circ\text{F}$

Zero point stability

DN		Zero point stability	
[mm]	[inch]	[kg/h] or [l/h]	[lb/min]
8	3/8	0.20	0.007
15	1/2	0.65	0.024
25	1	1.80	0.066
40	1 1/2	4.50	0.165
50	2	7.00	0.257

Example for max. measured error

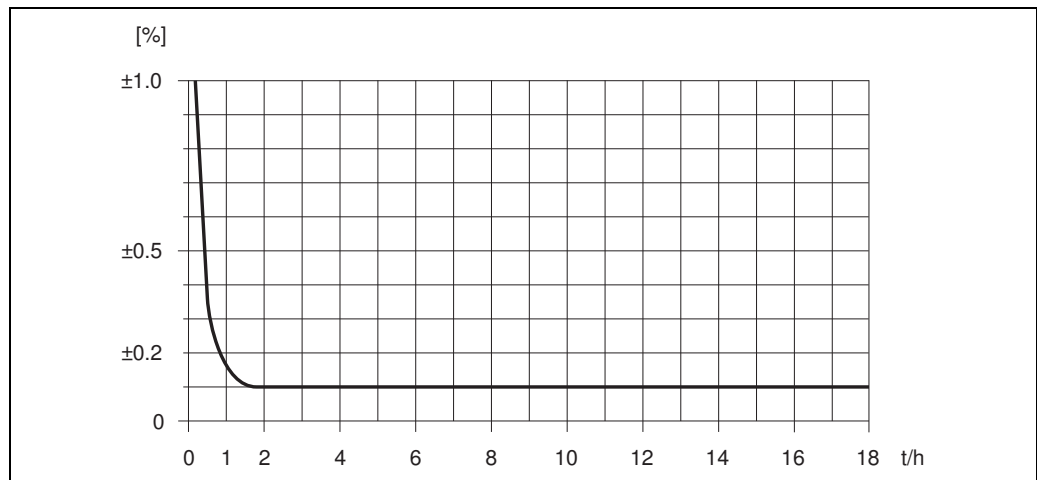

Fig. 43: Max. measured error in % o.r. (example: Promass H, DN 25)

Flow values (example)

Turn down	Flow		Maximum measured error [% o.r.]
	[kg/h]	[lb/min]	
250 : 1	72	2.646	2.50
100 : 1	180	6.615	1.00
25 : 1	720	26.46	0.25
10 : 1	1800	66.15	0.10
2 : 1	9000	330.75	0.10

Design fundamentals →  116

Repeatability

Design fundamentals →  116.

Material measuring tube: Zirconium 702/R 60702

- Mass flow and volume flow (liquids): $\pm 0.05\%$ o.r.
- Density (liquids): ± 0.00025 g/cm³
- Temperature: ± 0.25 °C $\pm 0.0025 \cdot T$ °C; ± 0.5 °F $\pm 0.0015 \cdot (T - 32)$ °F

Material measuring tube: Tantalum 2.5W

- Mass flow and volume flow (liquids): $\pm 0.05\%$ o.r.
- Mass flow (gases): $\pm 0.25\%$ o.r.
- Density (liquids): ± 0.0005 g/cm³
- Temperature: ± 0.25 °C $\pm 0.0025 \cdot T$ °C; ± 0.5 °F $\pm 0.0015 \cdot (T - 32)$ °F

Influence of medium temperature

When there is a difference between the temperature for zero point adjustment and the process temperature, the typical measured error of the sensor is $\pm 0.0002\%$ of the full scale value / °C ($\pm 0.0001\%$ of the full scale value/°F).

Influence of medium pressure

The table below shows the effect on accuracy of mass flow due to a difference between calibration pressure and process pressure.

DN		Promass H Zirconium 702/R 60702	Promass H Tantalum 2.5W
[mm]	[inch]	[% o.r./bar]	[% o.r./bar]
8	3/8	-0.017	-0.010
15	1/2	-0.021	-0.010
25	1	-0.013	-0.012
40	1 1/2	-0.018	-
50	2	-0.020	-

Design fundamentals

Dependent on the flow:

- Flow \geq Zero point stability \div (Base accuracy \div 100)
 - Max. measured error: \pm Base accuracy in % o.r.
 - Repeatability: $\pm 1/2 \cdot$ Base accuracy in % o.r.
- Flow $<$ Zero point stability \div (Base accuracy \div 100)
 - Max. measured error: \pm (Zero point stability \div measured value) \cdot 100% o.r.
 - Repeatability: $\pm 1/2 \cdot$ (Zero point stability \div measured value) \cdot 100% o.r.

Base accuracy for	
Mass flow liquids	0.10
Volume flow liquids	0.10
Mass flow gases	0.50

Performance characteristic
Promass I

o.r. = of reading; $1 \text{ g/cm}^3 = 1 \text{ kg/l}$; T = medium temperature

Maximum measured error

The following values refer to the pulse/frequency output.
The additional measured error at the current output is typically $\pm 5 \mu\text{A}$.
Design fundamentals \rightarrow 118.

- Mass flow and volume flow (liquids): $\pm 0.10\%$ o.r.
- Mass flow (gases): $\pm 0.50\%$ o.r.
- Density (liquids)
 - Reference conditions: $\pm 0.0005 \text{ g/cm}^3$
 - Field density calibration: $\pm 0.0005 \text{ g/cm}^3$
(valid after field density calibration under process conditions)
 - Standard density calibration: $\pm 0.02 \text{ g/cm}^3$
(valid over the entire temperature range and density range \rightarrow 128)
 - Special density calibration: $\pm 0.004 \text{ g/cm}^3$
(optional, valid range: $+10$ to $+80 \text{ }^\circ\text{C}$ ($+50$ to $+176 \text{ }^\circ\text{F}$) and 0.0 to 2.0 g/cm^3)
- Temperature: $\pm 0.5 \text{ }^\circ\text{C} \pm 0.005 \cdot T \text{ }^\circ\text{C}$; $\pm 1 \text{ }^\circ\text{F} \pm 0.003 \cdot (T - 32) \text{ }^\circ\text{F}$

Zero point stability

DN		Zero point stability	
[mm]	[inch]	[kg/h] or [l/h]	[lb/min]
8	3/8	0.150	0.0055
15	1/2	0.488	0.0179
15 FB	1/2 FB	1.350	0.0496
25	1	1.350	0.0496
25 FB	1 FB	3.375	0.124
40	1 1/2	3.375	0.124
40 FB	1 1/2 FB	5.250	0.193
50	2	5.250	0.193
50 FB	2 FB	13.50	0.496
80	3	13.50	0.496

FB = Full bore

Example for max. measured error

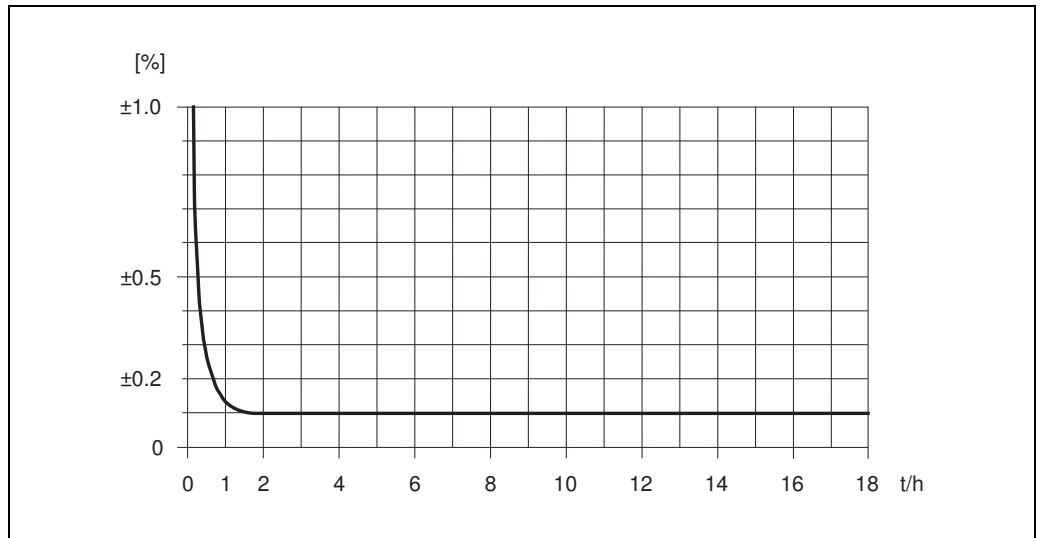

Fig. 44: Max. measured error in % o.r. (example: Promass I, DN 25)

Flow values (example)

Turn down	Flow		Maximum measured error [% o.r.]
	[kg/h]	[lb/min]	
250 : 1	72	2.646	1.875
100 : 1	180	6.615	0.750
25 : 1	720	26.46	0.188
10 : 1	1800	66.15	0.100
2 : 1	9000	330.75	0.100

Design fundamentals → 118

Repeatability

Design fundamentals → 118

- Mass flow and volume flow (liquids): ±0.05% o.r.
- Mass flow (gases): ±0.25% o.r.
- Density (liquids): ±0.00025 g/cm³
- Temperature: ±0.25 °C ± 0.0025 · T °C; ±0.5 °F ± 0.0015 · (T - 32) °F

Influence of medium temperature

When there is a difference between the temperature for zero point adjustment and the process temperature, the typical measured error of the sensor is ±0.0002% of the full scale value / °C (±0.0001% of the full scale value/°F).

Influence of medium pressure

The table below shows the effect on accuracy of mass flow due to a difference between calibration pressure and process pressure.

DN		[% o.r./bar]
[mm]	[inch]	
8	3/8	0.006
15	1/2	0.004
15 FB	1/2 FB	0.006
25	1	0.006
25 FB	1 FB	no influence
40	1 1/2	no influence
40 FB	1 1/2 FB	-0.003
50	2	-0.003
50 FB	2 FB	0.003
80	3	0.003

FB = Full bore

Design fundamentals

Dependent on the flow:

- Flow ≥ Zero point stability ÷ (Base accuracy ÷ 100)
 - Max. measured error: ±Base accuracy in % o.r.
 - Repeatability: ± 1/2 · Base accuracy in % o.r.
- Flow < Zero point stability ÷ (Base accuracy ÷ 100)
 - Max. measured error: ± (Zero point stability ÷ measured value) · 100% o.r.
 - Repeatability: ± 1/2 · (Zero point stability ÷ measured value) · 100% o.r.

Base accuracy for	
Mass flow liquids	0.10
Volume flow liquids	0.10
Mass flow gases	0.50

Performance characteristic
Promass O

o.r. = of reading; 1 g/cm³ = 1 kg/l; T = medium temperature

Maximum measured error

The following values refer to the pulse/frequency output.
The additional measured error at the current output is typically ±5 µA.
Design fundamentals →  120.

- Mass flow and volume flow (liquids):
 - ±0.05% o.r. (PremiumCal, for mass flow)
 - ±0.10% o.r.
- Mass flow (gases): ±0.35% o.r.
- Density (liquids)
 - Reference conditions: ±0.0005 g/cm³
 - Field density calibration: ±0.0005 g/cm³
(valid after field density calibration under process conditions)
 - Standard density calibration: ±0.01 g/cm³
(valid over the entire temperature range and density range →  128)

- Special density calibration: $\pm 0.001 \text{ g/cm}^3$
(optional, valid range: $+5$ to $+80 \text{ }^\circ\text{C}$ ($+41$ to $+176 \text{ }^\circ\text{F}$) and 0.0 to 2.0 g/cm^3)
- Temperature: $\pm 0.5 \text{ }^\circ\text{C} \pm 0.005 \cdot T \text{ }^\circ\text{C}$; $\pm 1 \text{ }^\circ\text{F} \pm 0.003 \cdot (T - 32) \text{ }^\circ\text{F}$

Zero point stability

DN		Zero point stability Promass F (Standard)	
[mm]	[inch]	[kg/h] or [l/h]	[lb/min]
80	3	9.00	0.330
100	4	14.00	0.514
150	6	32.00	1.17

Example for max. measured error

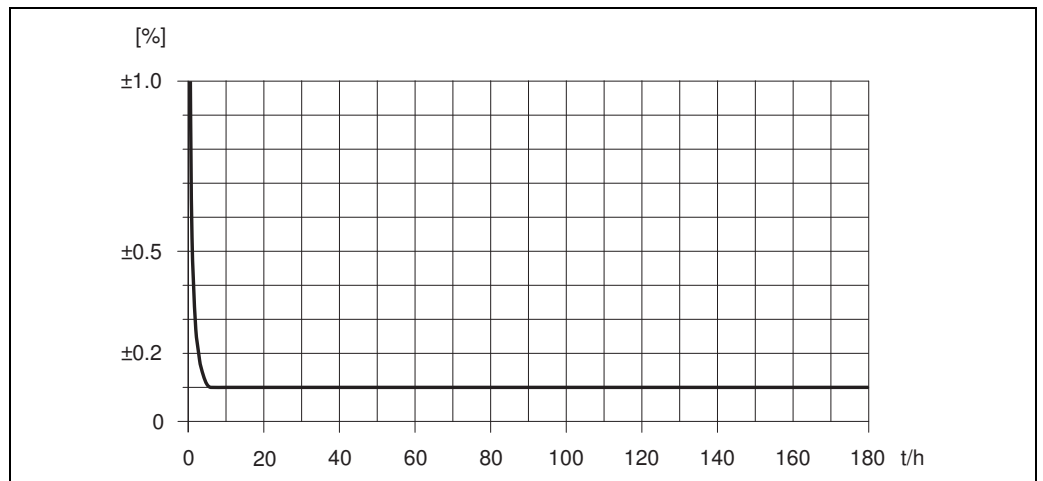

Fig. 45: Max. measured error in % o.r. (example DN 80)

Flow values (example DN 80)

Turn down	Flow		Maximum measured error [% o.r.]
	[kg/h]	[lb/min]	
500 : 1	360	13.23	1.5
100 : 1	1800	66.15	0.3
25 : 1	7200	264.6	0.1
10 : 1	18000	661.5	0.1
2 : 1	90000	3307.5	0.1

Design fundamentals → 120

Repeatability

Design fundamentals → 120.

- Mass flow and volume flow (liquids):
 ±0.025% o.r. (PremiumCal, for mass flow)
 ±0.05% o.r.
- Mass flow (gases): ±0.25% o.r.
- Density (liquids): ±0.00025 g/cm³
- Temperature: ±0.25 °C ± 0.0025 · T °C; ±0.5 °F ± 0.0015 · (T - 32) °F

Influence of medium temperature

When there is a difference between the temperature for zero point adjustment and the process temperature, the typical measured error of the sensor is ±0.0002% of the full scale value / °C (±0.0001% of the full scale value/°F).

Influence of medium pressure

The table below shows the effect on accuracy of mass flow due to a difference between calibration pressure and process pressure.

DN		Promass F (standard)
[mm]	[inch]	[% o.r./bar]
80	3	-0.0055
100	4	-0.0035
150	6	-0.002

Design fundamentals

Dependent on the flow:

- Flow ≥ Zero point stability ÷ (Base accuracy ÷ 100)
 - Max. measured error: ±Base accuracy in % o.r.
 - Repeatability: ± ½ · Base accuracy in % o.r.
- Flow < Zero point stability ÷ (Base accuracy ÷ 100)
 - Max. measured error: ± (Zero point stability ÷ measured value) · 100% o.r.
 - Repeatability: ± ½ · (Zero point stability ÷ measured value) · 100% o.r.

Base accuracy for	
Mass flow liquids, PremiumCal	0.05
Mass flow liquids	0.10
Volume flow liquids	0.10
Mass flow gases	0.35

Performance characteristic Promass P o.r. = of reading; $1 \text{ g/cm}^3 = 1 \text{ kg/l}$; T = medium temperature

Maximum measured error

The following values refer to the pulse/frequency output.
 The additional measured error at the current output is typically $\pm 5 \mu\text{A}$.
 Design fundamentals → 122.

- Mass flow and volume flow (liquids): $\pm 0.10\%$ o.r.
- Mass flow (gases): $\pm 0.50\%$ o.r.
- Density (liquids)
 - Reference conditions: $\pm 0.0005 \text{ g/cm}^3$
 - Field density calibration: $\pm 0.0005 \text{ g/cm}^3$
(valid after field density calibration under process conditions)
 - Standard density calibration: $\pm 0.01 \text{ g/cm}^3$
(valid over the entire temperature range and density range → 128)
 - Special density calibration: $\pm 0.002 \text{ g/cm}^3$
(optional, valid range: $+5$ to $+80 \text{ }^\circ\text{C}$ ($+41$ to $+176 \text{ }^\circ\text{F}$) and 0.0 to 2.0 g/cm^3)
- Temperature: $\pm 0.5 \text{ }^\circ\text{C} \pm 0.005 \cdot T \text{ }^\circ\text{C}$; $\pm 1 \text{ }^\circ\text{F} \pm 0.003 \cdot (T - 32) \text{ }^\circ\text{F}$

Zero point stability

DN		Zero point stability	
[mm]	[inch]	[kg/h] or [l/h]	[lb/min]
8	3/8	0.20	0.007
15	1/2	0.65	0.024
25	1	1.80	0.066
40	1 1/2	4.50	0.165
50	2	7.00	0.257

Example for max. measured error

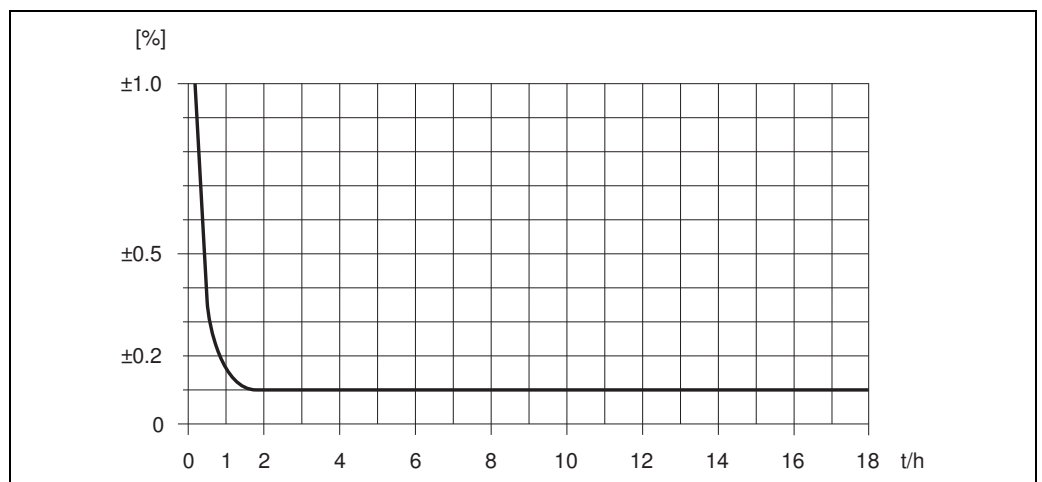

Fig. 46: Max. measured error in % o.r. (example: Promass P, DN 25)

Flow values (example)

Turn down	Flow		Maximum measured error [% o.r.]
	[kg/h]	[lb/min]	
250 : 1	72	2.646	2.50
100 : 1	180	6.615	1.00
25 : 1	720	26.46	0.25
10 : 1	1800	66.15	0.10
2 : 1	9000	330.75	0.10

Design fundamentals → 122

Repeatability

Design fundamentals → 122.

- Mass flow and volume flow (liquids): ±0.05% o.r.
- Mass flow (gases): ±0.25% o.r.
- Density (liquids): ±0.00025 g/cm³
- Temperature: ±0.25 °C ± 0.0025 · T °C; ±0.5 °F ± 0.0015 · (T - 32) °F

Influence of medium temperature

When there is a difference between the temperature for zero point adjustment and the process temperature, the typical measured error of the sensor is ±0.0002% of the full scale value / °C (±0.0001% of the full scale value/°F).

Influence of medium pressure

The table below shows the effect on accuracy of mass flow due to a difference between calibration pressure and process pressure.

DN		[% o.r./bar]
[mm]	[inch]	
8	3/8	-0.002
15	½	-0.006
25	1	-0.005
40	1½	-0.005
50	2	-0.005

Design fundamentals

Dependent on the flow:

- Flow ≥ Zero point stability ÷ (Base accuracy ÷ 100)
 - Max. measured error: ±Base accuracy in % o.r.
 - Repeatability: ± ½ · Base accuracy in % o.r.
- Flow < Zero point stability ÷ (Base accuracy ÷ 100)
 - Max. measured error: ± (Zero point stability ÷ measured value) · 100% o.r.
 - Repeatability: ± ½ · (Zero point stability ÷ measured value) · 100% o.r.

Base accuracy for	
Mass flow liquids	0.10
Volume flow liquids	0.10
Mass flow gases	0.50

Performance characteristic
Promass S

o.r. = of reading; $1 \text{ g/cm}^3 = 1 \text{ kg/l}$; T = medium temperature

Maximum measured error

The following values refer to the pulse/frequency output.
The additional measured error at the current output is typically $\pm 5 \mu\text{A}$.
Design fundamentals → 124.

- Mass flow and volume flow (liquids): $\pm 0.10\%$ o.r.
- Mass flow (gases): $\pm 0.50\%$ o.r.
- Density (liquids)
 - Reference conditions: $\pm 0.0005 \text{ g/cm}^3$
 - Field density calibration: $\pm 0.0005 \text{ g/cm}^3$
(valid after field density calibration under process conditions)
 - Standard density calibration: $\pm 0.01 \text{ g/cm}^3$
(valid over the entire temperature range and density range → 128)
 - Special density calibration: $\pm 0.002 \text{ g/cm}^3$
(optional, valid range: $+5$ to $+80 \text{ }^\circ\text{C}$ ($+41$ to $+176 \text{ }^\circ\text{F}$) and 0.0 to 2.0 g/cm^3)
- Temperature: $\pm 0.5 \text{ }^\circ\text{C} \pm 0.005 \cdot T \text{ }^\circ\text{C}$; $\pm 1 \text{ }^\circ\text{F} \pm 0.003 \cdot (T - 32) \text{ }^\circ\text{F}$

Zero point stability

DN		Zero point stability	
[mm]	[inch]	[kg/h] or [l/h]	[lb/min]
8	3/8	0.20	0.007
15	1/2	0.65	0.024
25	1	1.80	0.066
40	1 1/2	4.50	0.165
50	2	7.00	0.257

Example for max. measured error

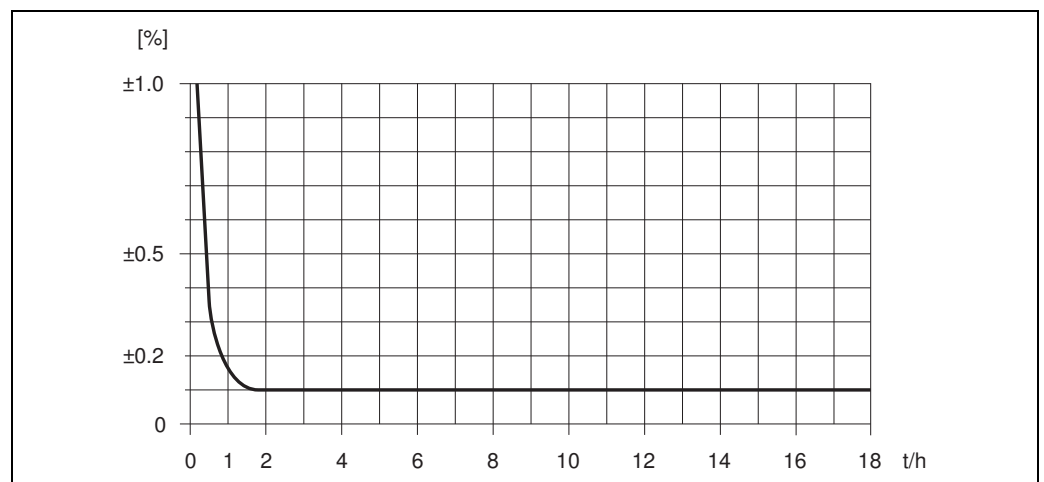

Fig. 47: Max. measured error in % o.r. (example: Promass S, DN 25)

Flow values (example)

Turn down	Flow		Maximum measured error [% o.r.]
	[kg/h]	[lb/min]	
250 : 1	72	2.646	2.50
100 : 1	180	6.615	1.00
25 : 1	720	26.46	0.25
10 : 1	1800	66.15	0.10
2 : 1	9000	330.75	0.10

Design fundamentals → 124

Repeatability

Design fundamentals → 124.

- Mass flow and volume flow (liquids): ±0.05% o.r.
- Mass flow (gases): ±0.25% o.r.
- Density (liquids): ±0.00025 g/cm³
- Temperature: ±0.25 °C ± 0.0025 · T °C; ±0.5 °F ± 0.0015 · (T - 32) °F

Influence of medium temperature

When there is a difference between the temperature for zero point adjustment and the process temperature, the typical measured error of the sensor is ±0.0002% of the full scale value / °C (±0.0001% of the full scale value/°F).

Influence of medium pressure

The table below shows the effect on accuracy of mass flow due to a difference between calibration pressure and process pressure.

DN		[% o.r./bar]
[mm]	[inch]	
8	3/8	-0.002
15	½	-0.006
25	1	-0.005
40	1½	-0.005
50	2	-0.005

Design fundamentals

Dependent on the flow:

- Flow ≥ Zero point stability ÷ (Base accuracy ÷ 100)
 - Max. measured error: ±Base accuracy in % o.r.
 - Repeatability: ± ½ · Base accuracy in % o.r.
- Flow < Zero point stability ÷ (Base accuracy ÷ 100)
 - Max. measured error: ± (Zero point stability ÷ measured value) · 100% o.r.
 - Repeatability: ± ½ · (Zero point stability ÷ measured value) · 100% o.r.

Base accuracy for	
Mass flow liquids	0.10
Volume flow liquids	0.10
Mass flow gases	0.50

Performance characteristic
Promass X

o.r. = of reading; $1 \text{ g/cm}^3 = 1 \text{ kg/l}$; T = medium temperature

Maximum measured error

The following values refer to the pulse/frequency output.
The additional measured error at the current output is typically $\pm 5 \mu\text{A}$.
Design fundamentals → 126.

- Mass flow and volume flow (liquids):
 - ±0.05% o.r. (PremiumCal, for mass flow)
 - ±0.10% o.r.
- Density (liquids)
 - Reference conditions: $\pm 0.0005 \text{ g/cm}^3$
 - Field density calibration: $\pm 0.0005 \text{ g/cm}^3$
(valid after field density calibration under process conditions)
 - Standard density calibration: $\pm 0.01 \text{ g/cm}^3$
(valid over the entire temperature range and density range → 128)
 - Special density calibration: $\pm 0.001 \text{ g/cm}^3$
(optional, valid range: +5 to +80 °C (+41 to +176 °F) and 0.0 to 2.0 g/cm³)
- Temperature: $\pm 0.5 \text{ °C} \pm 0.005 \cdot T \text{ °C}$; $\pm 1 \text{ °F} \pm 0.003 \cdot (T - 32) \text{ °F}$

Zero point stability

DN		Zero point stability Promass F (Standard)	
[mm]	[inch]	[kg/h] or [l/h]	[lb/min]
350	14	175	6.42

Example for max. measured error

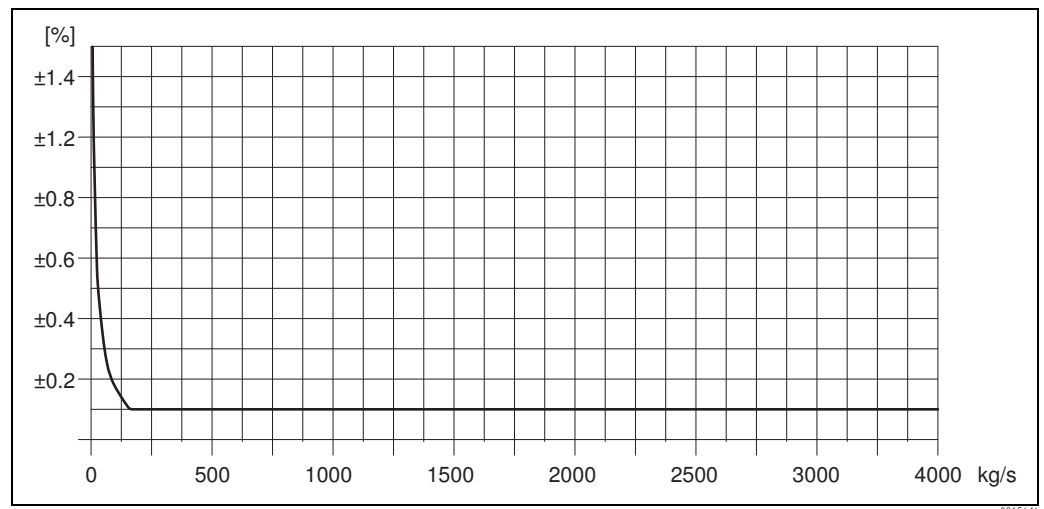

Fig. 48: Max. measured error in % o.r. (example: Promass 83X, DN 350)

Flow values (example)

Turn down	Flow		Maximum measured error [% o.r.]
	[kg/h]	[lb/min]	
500 : 1	8200	1.323	2.1
100 : 1	41 000	6.615	0.4
25 : 1	164 000	26.46	0.1
10 : 1	410 000	66.15	0.1
2 : 1	2 050 000	330.75	0.1

Design fundamentals → 126

Repeatability

Design fundamentals → 126.

- Mass flow and volume flow (liquids):
±0.025% o.r. (PremiumCal, for mass flow)
±0.05% o.r.
- Density (liquids): ±0.00025 g/cm³
- Temperature: ±0.25 °C ± 0.0025 · T °C; ±0.5 °F ± 0.0015 · (T - 32) °F

Influence of medium temperature

When there is a difference between the temperature for zero point adjustment and the process temperature, the typical measured error of the sensor is ±0.0002% of the full scale value / °C (±0.0001% of the full scale value/°F).

Influence of medium pressure

The table below shows the effect on accuracy of mass flow due to a difference between calibration pressure and process pressure.

DN		Promass F (standard) [% o.r./bar]
[mm]	[inch]	
350	14	-0.009



Design fundamentals

Dependent on the flow:

- Flow ≥ Zero point stability ÷ (Base accuracy ÷ 100)
 - Max. measured error: ±Base accuracy in % o.r.
 - Repeatability: ± ½ · Base accuracy in % o.r.
- Flow < Zero point stability ÷ (Base accuracy ÷ 100)
 - Max. measured error: ± (Zero point stability ÷ measured value) · 100% o.r.
 - Repeatability: ± ½ · (Zero point stability ÷ measured value) · 100% o.r.

Base accuracy for	
Mass flow liquids, PremiumCal	0.05
Mass flow liquids	0.10
Volume flow liquids	0.10

10.1.7 Operating conditions: Installation

Installation instructions	→  14
Inlet and outlet runs	There are no installation requirements regarding inlet and outlet runs.
Length of connecting cable, remote version	max. 20 m (65 ft)
System pressure	→  15

10.1.8 Operating conditions: Environment

Ambient temperature range	<p>Sensor and transmitter</p> <ul style="list-style-type: none"> ■ Standard: -20 to +60 °C (-4 to +140 °F) ■ Optional: -40 to +60 °C (-40 to +140 °F) <p> Note!</p> <ul style="list-style-type: none"> ■ Install the device at a shady location. Avoid direct sunlight, particularly in warm climatic regions. ■ At ambient temperatures below -20 °C (-4 °F) the readability of the display may be impaired.
Storage temperature	-40 to +80 °C (-40 to +175 °F); preferably at +20 °C (+68 °F)
Degree of protection	Standard: IP 67 (NEMA 4X) for transmitter and sensor
Shock resistance	According to IEC 60068-2-31
Vibration resistance	Acceleration up to 1 g, 10 to 150 Hz, following IEC 60068-2-6
CIP cleaning	Yes
SIP cleaning	Yes
Electromagnetic compatibility (EMC)	To IEC/EN 61326 and NAMUR Recommendation NE 21

10.1.9 Operating conditions: Process

Medium temperature range

Sensor:

Promass F, A, P:

–50 to +200 °C (–58 to +392 °F)

Promass F (high-temperature version):

–50 to +350 °C (–58 to +662 °F)

Promass H:

■ Zirconium 702/R 60702: –50 to +200 °C (–58 to +392 °F)

■ Tantalum 2.5W: –50 to +150 °C (–58 to +302 °F)

Promass I, S:

–50 to +150 °C (–58 to +302 °F)

Promass E:

–40 to +140 °C (–40 to +284 °F)

Promass O

–40 to +200 °C (–40 to +392 °F)

Promass X

–50 to +180 °C (–40 to +356 °F)

Seals:

Promass F, E, H, I, S, P, O, X:

No internal seals

Promass A

No seals inlying.

Only for mounting sets with threaded connections:

Viton: –15 to +200 °C (–5 to +392 °F)

EPDM: –40 to +160 °C (–40 to +320 °F)

Silicon: –60 to +200 °C (–76 to +392 °F)

Kalrez: –20 to +275 °C (–4 to +527 °F);

Fluid density range

0 to 5000 kg/m³ (0 to 312 lb/cf)

Limiting medium pressure range (rated pressure) The material load diagrams (pressure-temperature diagrams) for the process connections are provided in the separate "Technical Information" document on the device in question. This can be downloaded as a PDF file from www.endress.com. A list of the "Technical Information" documents available is provided in the "Documentation" section → [☰ 147](#).

Pressure ranges of secondary containment:

Promass A:

25 bar (362) psi

Promass E:

No secondary containment

Promass F:

DN 8 to 50 (3/8" to 2"): 40 bar (580 psi)

DN 80 (3"): 25 bar (362 psi)

DN 100 to 150 (4" to 6"): 16 bar (232 psi)

DN 250(10"): 10 bar (145 psi)

Promass H:

■ Zirconium 702/R 60702:

DN 8 to 15 (3/8" to 1/2"): 25 bar (362 psi)

DN 25 to 50 (1" to 2"): 16 bar (232 psi)

■ Tantalum 2.5W:

DN 8 to 25 (3/8" to 1"): 25 bar (362 psi)

DN 40 to 50 (1 1/2" to 2"): 16 bar (232 psi)

Promass I:

40 bar (580 psi)

Promass P:

DN 8 to 25 (3/8" to 1"): 25 bar (362 psi)

DN 40 (1 1/2"): 16 bar (232 psi)

DN 50 (2"): 10 bar (145 psi)

Promass S:

DN 8 to 40 (3/8" to 1 1/2"): 16 bar (232 psi)

DN 50 (2"): 10 bar (145 psi)

Promass O:

16 bar (232 psi)

Promass X:

Type approved, maximum allowable pressure according to ASME BPVC: 6 bar (87 psi)

Limiting flow

See the "Measuring range" section → Page 101 ff.

Select nominal diameter by optimizing between required flow range and permissible pressure loss. See the "Measuring range" section for a list of max. possible full scale values.

- The minimum recommended full scale value is approx. 1/20 of the max. full scale value.
- In most applications, 20 to 50% of the maximum full scale value can be considered ideal.
- Select a lower full scale value for abrasive substances such as liquids with entrained solids (flow velocity < 1 m/s (3 ft/s)).
- For gas measurement the following rules apply:
 - Flow velocity in the measuring tubes should not be more than half the sonic velocity (0.5 Mach).
 - The maximum mass flow depends on the density of the gas: formula → 100

Pressure loss (SI units)

Pressure loss depends on the properties of the fluid and on its flow. The following formulas can be used to approximately calculate the pressure loss:

Pressure loss formulas for Promass F, E

Reynolds number	$Re = \frac{2 \cdot \dot{m}}{\pi \cdot d \cdot v \cdot \rho}$	a0004623
Re ≥ 2300 ¹⁾	$\Delta p = K \cdot v^{0.25} \cdot \dot{m}^{1.85} \cdot \rho^{-0.86}$	a0004626
	Promass F DN 250 $\Delta p = K \cdot \left[1 - a + \frac{a}{e^{b \cdot (v - 10^{-6})}} \right] \cdot v^{0.25} \cdot \dot{m}^{1.85} \cdot \rho^{-0.86}$	a0012135
Re < 2300	$\Delta p = K1 \cdot v \cdot \dot{m} + \frac{K2 \cdot v^{0.25} \cdot \dot{m}^2}{\rho}$	a0004628
Δp = pressure loss [mbar] v = kinematic viscosity [m ² /s] \dot{m} = mass flow [kg/s] ρ = fluid density [kg/m ³] d = inside diameter of measuring tubes [m] K to K2 = constants (depending on nominal diameter) a = 0.3 b = 91000 ¹⁾ To compute the pressure loss for gases, always use the formula for Re ≥ 2300.		

Pressure loss formulas for Promass H, I, S, P

Reynolds number	$Re = \frac{4 \cdot \dot{m}}{\pi \cdot d \cdot v \cdot \rho}$	a0003381
Re ≥ 2300 ¹⁾	$\Delta p = K \cdot v^{0.25} \cdot \dot{m}^{1.75} \cdot \rho^{-0.75} + \frac{K3 \cdot \dot{m}^2}{\rho}$	a0004631
Re < 2300	$\Delta p = K1 \cdot v \cdot \dot{m} + \frac{K3 \cdot \dot{m}^2}{\rho}$	a0004633
Δp = pressure loss [mbar] v = kinematic viscosity [m ² /s] \dot{m} = mass flow [kg/s] ρ = fluid density [kg/m ³] d = inside diameter of measuring tubes [m] K to K3 = constants (depending on nominal diameter) ¹⁾ To compute the pressure loss for gases, always use the formula for Re ≥ 2300.		

Pressure loss formulas for Promass A

Reynolds number	$Re = \frac{4 \cdot \dot{m}}{\pi \cdot d \cdot v \cdot \rho}$	A0003381
$Re \geq 2300^{1)}$	$\Delta p = K \cdot v^{0.25} \cdot \dot{m}^{1.75} \cdot \rho^{-0.75}$	A0003380
$Re < 2300$	$\Delta p = K1 \cdot v \cdot \dot{m}$	A0003379
<p>Δp = pressure loss [mbar] ρ = density [kg/m³] v = kinematic viscosity [m²/s] d = inside diameter of measuring tubes [m] \dot{m} = mass flow [kg/s] K to $K1$ = constants (depending on nominal diameter)</p> <p>¹⁾ To compute the pressure loss for gases, always use the formula for $Re \geq 2300$.</p>		

Pressure loss formulas for Promass O, X

Reynolds number	$Re = \frac{4 \cdot \dot{m}}{\pi \cdot d \cdot v \cdot \rho \cdot n}$	A0015582
Pressure loss	$\Delta p = (A_0 + A_1 \cdot Re^{A_2})^{1/A_3} \cdot \frac{1}{\rho} \cdot \left(\frac{2 \cdot \dot{m}}{5 \cdot \pi \cdot n \cdot d^2} \right)^2$	A0015583
<p>Δp = pressure loss [mbar] d = inside diameter of measuring tubes [m] v = kinematic viscosity [m²/s] A_0 to A_3 = constants (depending on nominal diameter) \dot{m} = mass flow [kg/s] n = number of tubes ρ = density [kg/m³]</p>		

Pressure loss coefficient for Promass F

DN	d[m]	K	K1	K2
8	$5.35 \cdot 10^{-3}$	$5.70 \cdot 10^7$	$9.60 \cdot 10^7$	$1.90 \cdot 10^7$
15	$8.30 \cdot 10^{-3}$	$5.80 \cdot 10^6$	$1.90 \cdot 10^7$	$10.60 \cdot 10^5$
25	$12.00 \cdot 10^{-3}$	$1.90 \cdot 10^6$	$6.40 \cdot 10^6$	$4.50 \cdot 10^5$
40	$17.60 \cdot 10^{-3}$	$3.50 \cdot 10^5$	$1.30 \cdot 10^6$	$1.30 \cdot 10^5$
50	$26.00 \cdot 10^{-3}$	$7.00 \cdot 10^4$	$5.00 \cdot 10^5$	$1.40 \cdot 10^4$
80	$40.50 \cdot 10^{-3}$	$1.10 \cdot 10^4$	$7.71 \cdot 10^4$	$1.42 \cdot 10^4$
100	$51.20 \cdot 10^{-3}$	$3.54 \cdot 10^3$	$3.54 \cdot 10^4$	$5.40 \cdot 10^3$
150	$68.90 \cdot 10^{-3}$	$1.36 \cdot 10^3$	$2.04 \cdot 10^4$	$6.46 \cdot 10^2$
250	$102.26 \cdot 10^{-3}$	$3.00 \cdot 10^2$	$6.10 \cdot 10^3$	$1.33 \cdot 10^2$

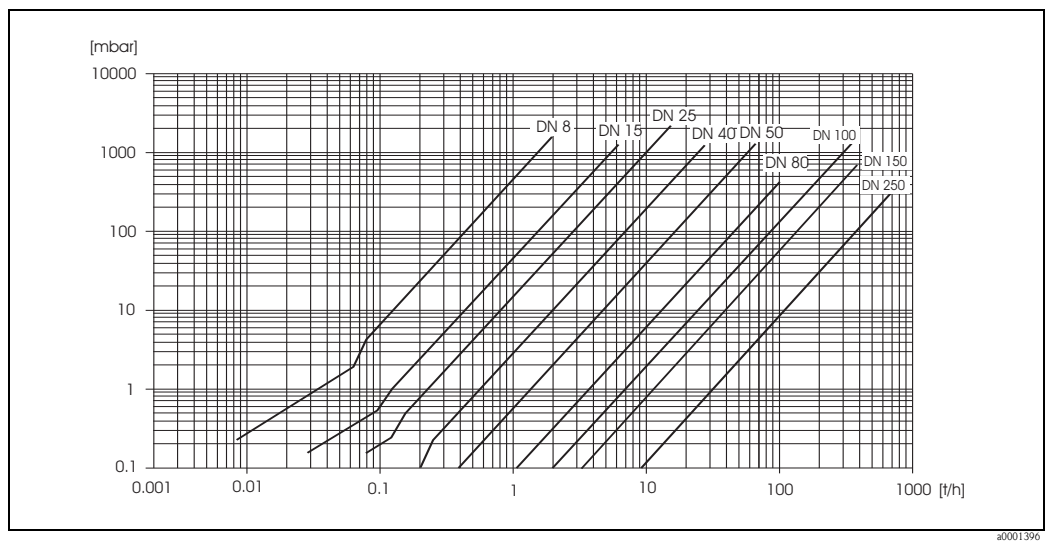

Fig. 49: Pressure loss diagram for water

Pressure loss coefficient for Promass E

DN	d[m]	K	K1	K2
8	$5.35 \cdot 10^{-3}$	$5.70 \cdot 10^7$	$7.91 \cdot 10^7$	$2.10 \cdot 10^7$
15	$8.30 \cdot 10^{-3}$	$7.62 \cdot 10^6$	$1.73 \cdot 10^7$	$2.13 \cdot 10^6$
25	$12.00 \cdot 10^{-3}$	$1.89 \cdot 10^6$	$4.66 \cdot 10^6$	$6.11 \cdot 10^5$
40	$17.60 \cdot 10^{-3}$	$4.42 \cdot 10^5$	$1.35 \cdot 10^6$	$1.38 \cdot 10^5$
50	$26.00 \cdot 10^{-3}$	$8.54 \cdot 10^4$	$4.02 \cdot 10^5$	$2.31 \cdot 10^4$
80	$40.50 \cdot 10^{-3}$	$1.44 \cdot 10^4$	$5.00 \cdot 10^4$	$2.30 \cdot 10^4$

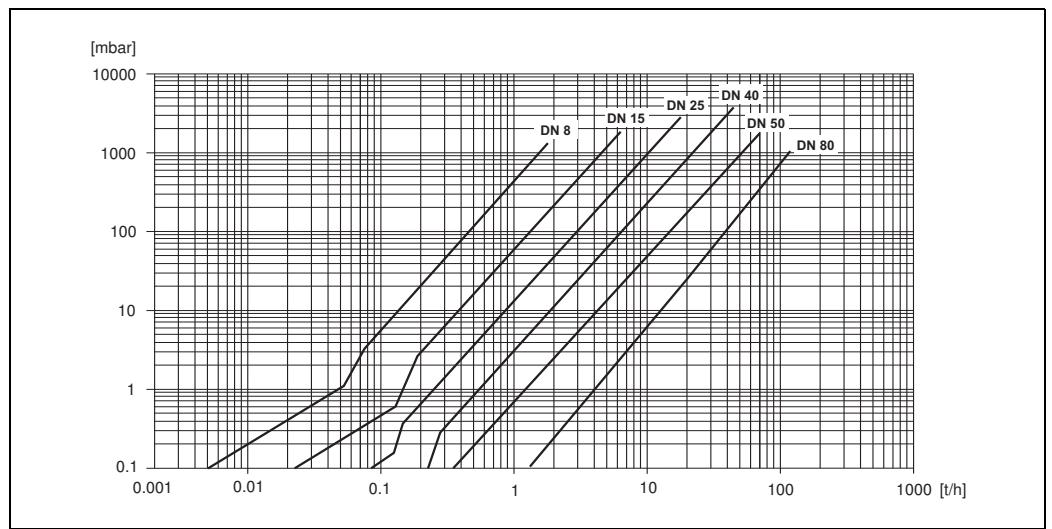

Fig. 50: Pressure loss diagram for water

Pressure loss coefficient for Promass A

DN	d[m]	K	K1
1	$1.1 \cdot 10^{-3}$	$1.2 \cdot 10^{11}$	$1.3 \cdot 10^{11}$
2	$1.8 \cdot 10^{-3}$	$1.6 \cdot 10^{10}$	$2.4 \cdot 10^{10}$
4	$3.5 \cdot 10^{-3}$	$9.4 \cdot 10^8$	$2.3 \cdot 10^9$
High pressure version			
2	$1.4 \cdot 10^{-3}$	$5.4 \cdot 10^{10}$	$6.6 \cdot 10^{10}$
4	$3.0 \cdot 10^{-3}$	$2.0 \cdot 10^9$	$4.3 \cdot 10^9$

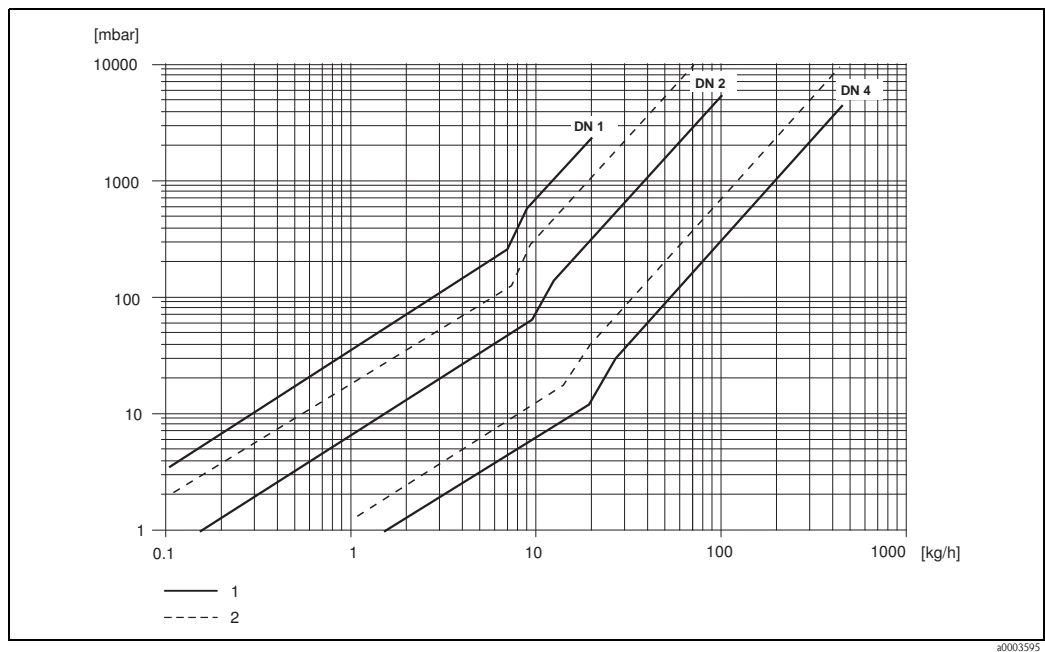

Fig. 51: Pressure loss diagram for water

- 1 Standard version
- 2 High pressure version

Pressure loss coefficient for Promass H

DN	d[m]	K	K1	K3
8	$8.51 \cdot 10^{-3}$	$8.04 \cdot 10^6$	$3.28 \cdot 10^7$	$1.15 \cdot 10^6$
15	$12.00 \cdot 10^{-3}$	$1.81 \cdot 10^6$	$9.99 \cdot 10^6$	$1.87 \cdot 10^5$
25	$17.60 \cdot 10^{-3}$	$3.67 \cdot 10^5$	$2.76 \cdot 10^6$	$4.99 \cdot 10^4$
40	$25.50 \cdot 10^{-3}$	$8.75 \cdot 10^4$	$8.67 \cdot 10^5$	$1.22 \cdot 10^4$
50	$40.5 \cdot 10^{-3}$	$1.35 \cdot 10^4$	$1.72 \cdot 10^5$	$1.20 \cdot 10^3$

Pressure loss data includes interface between measuring tube and piping

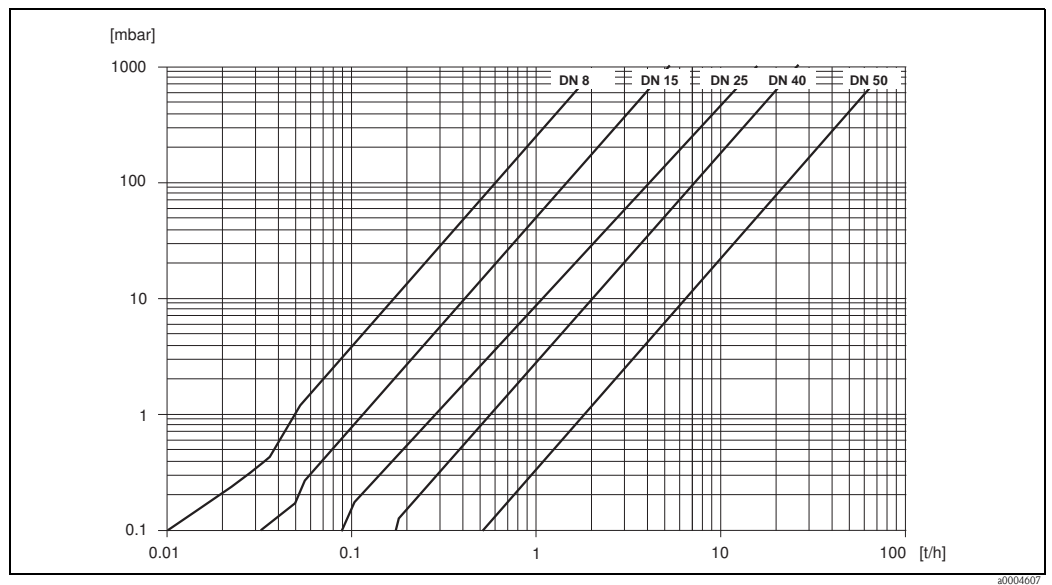

Fig. 52: *Pressure loss diagram for water*

Pressure loss coefficient for Promass I

DN	d[m]	K	K1	K3
8	$8.55 \cdot 10^{-3}$	$8.1 \cdot 10^6$	$3.9 \cdot 10^7$	$129.95 \cdot 10^4$
15	$11.38 \cdot 10^{-3}$	$2.3 \cdot 10^6$	$1.3 \cdot 10^7$	$23.33 \cdot 10^4$
15 ¹⁾	$17.07 \cdot 10^{-3}$	$4.1 \cdot 10^5$	$3.3 \cdot 10^6$	$0.01 \cdot 10^4$
25	$17.07 \cdot 10^{-3}$	$4.1 \cdot 10^5$	$3.3 \cdot 10^6$	$5.89 \cdot 10^4$
25 ¹⁾	$26.4 \cdot 10^{-3}$	$7.8 \cdot 10^4$	$8.5 \cdot 10^5$	$0.11 \cdot 10^4$
40	$26.4 \cdot 10^{-3}$	$7.8 \cdot 10^4$	$8.5 \cdot 10^5$	$1.19 \cdot 10^4$
40 ¹⁾	$35.62 \cdot 10^{-3}$	$1.3 \cdot 10^4$	$2.0 \cdot 10^5$	$0.08 \cdot 10^4$
50	$35.62 \cdot 10^{-3}$	$1.3 \cdot 10^4$	$2.0 \cdot 10^5$	$0.25 \cdot 10^4$
50 ¹⁾	$54.8 \cdot 10^{-3}$	$2.3 \cdot 10^3$	$5.5 \cdot 10^4$	$1.0 \cdot 10^2$
80	$54.8 \cdot 10^{-3}$	$2.3 \cdot 10^3$	$5.5 \cdot 10^4$	$3.5 \cdot 10^2$

Pressure loss data includes interface between measuring tube and piping

¹⁾ DN 15, 25, 40, 50 "FB" = Full bore versions of Promass I

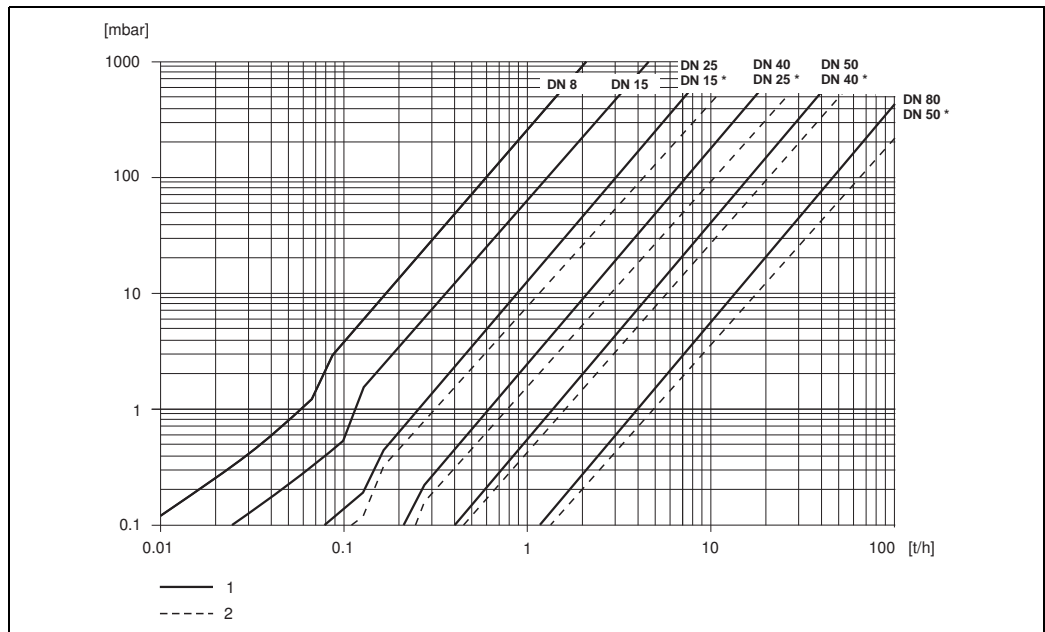

Fig. 53: Pressure loss diagram for water

- 1 Standard versions
- 2 Full bore versions (*)

Pressure loss coefficient for Promass S, P

DN	d[m]	K	K1	K3
8	$8.31 \cdot 10^{-3}$	$8.78 \cdot 10^6$	$3.53 \cdot 10^7$	$1.30 \cdot 10^6$
15	$12.00 \cdot 10^{-3}$	$1.81 \cdot 10^6$	$9.99 \cdot 10^6$	$1.87 \cdot 10^5$
25	$17.60 \cdot 10^{-3}$	$3.67 \cdot 10^5$	$2.76 \cdot 10^6$	$4.99 \cdot 10^4$
40	$26.00 \cdot 10^{-3}$	$8.00 \cdot 10^4$	$7.96 \cdot 10^5$	$1.09 \cdot 10^4$
50	$40.50 \cdot 10^{-3}$	$1.41 \cdot 10^4$	$1.85 \cdot 10^5$	$1.20 \cdot 10^3$

Pressure loss data includes interface between measuring tube and piping

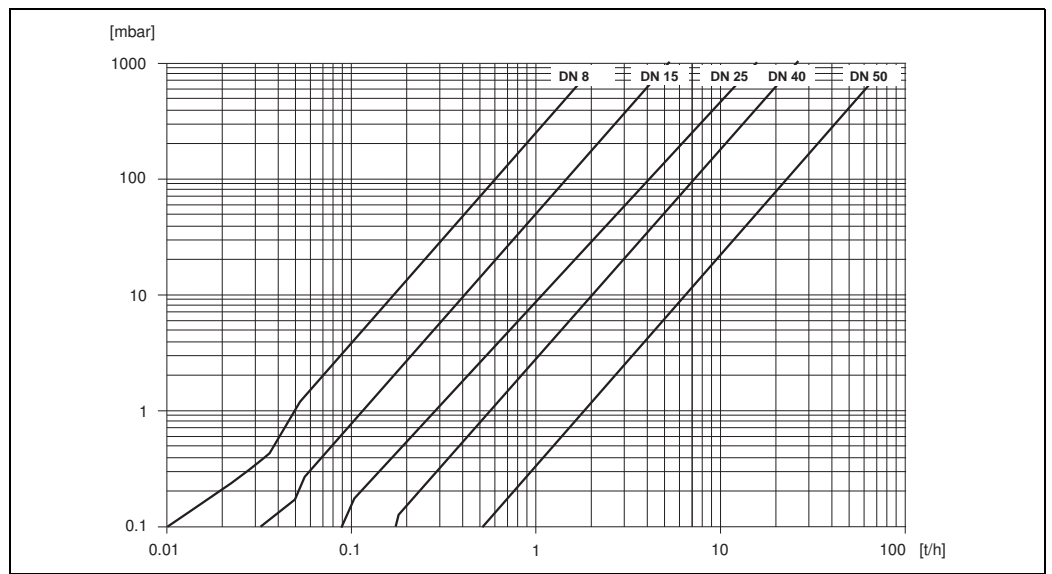

Fig. 54: Pressure loss diagram for water

Pressure loss coefficient for Promass O

DN		d[mm]	A ₀	A ₁	A ₂	A ₃
[mm]	[inch]					
80	3	38.5	0.72	4.28	- 0.36	0.24
100	4	49.0	0.70	3.75	- 0.35	0.22
150	6	66.1	0.75	2.81	- 0.33	0.19

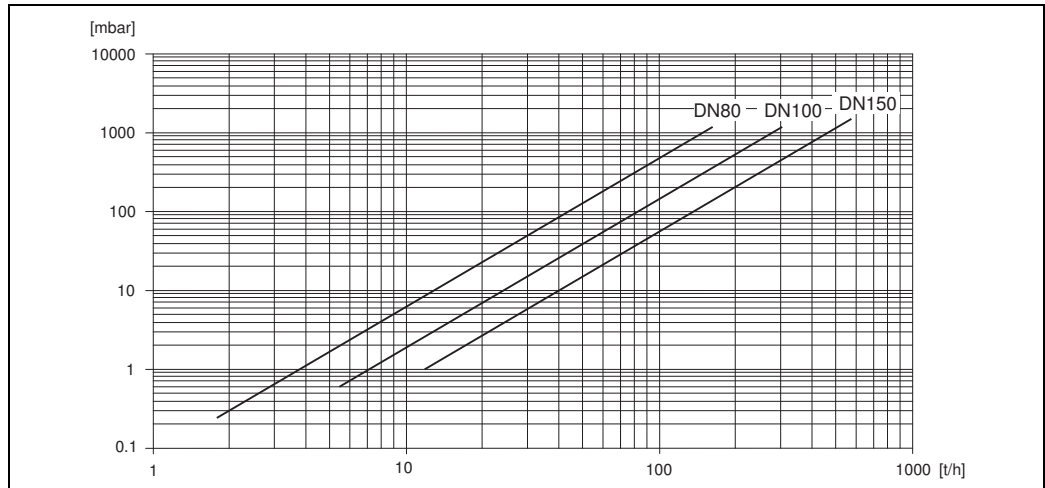

Fig. 55: *Pressure loss diagram for water*

Pressure loss coefficient for Promass X

DN		d[mm]	A ₀	A ₁	A ₂	A ₃
[mm]	[inch]					
350	14	102.3	0.76	3.80	- 0.33	0.23

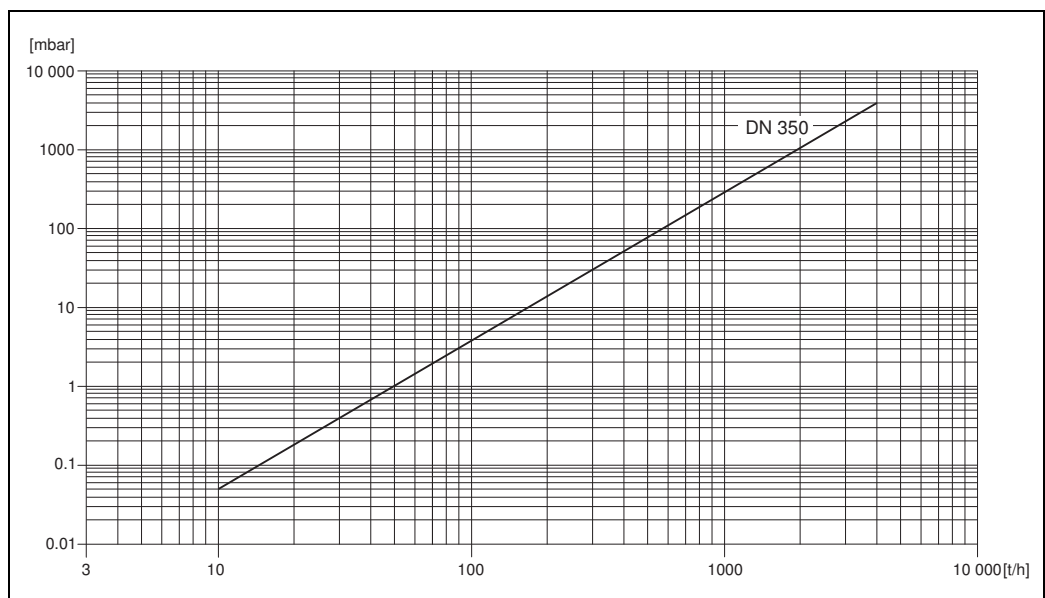

Fig. 56: *Pressure loss diagram for water*

Pressure loss (US units)

Pressure loss is dependent on fluid properties nominal diameter. Consult Endress+Hauser for Applicator PC software to determine pressure loss in US units. All important instrument data is contained in the Applicator software program in order to optimize the design of measuring system. The software is used for following calculations:

- Nominal diameter of the sensor with fluid characteristics such as viscosity, density, etc.
- Pressure loss downstream of the measuring point.
- Converting mass flow to volume flow, etc.
- Simultaneous display of various meter size.
- Determining measuring ranges.

The Applicator runs on any IBM compatible PC with windows.

10.1.10 Mechanical construction

Design / dimensions

The dimensions and lengths of the sensor and transmitter are provided in the separate "Technical Information" document on the device in question. This can be downloaded as a PDF file from www.endress.com. A list of the "Technical Information" documents available is provided in the "Documentation" section → [147](#).

Weight

- Compact version: see table below
- Remote version
 - Sensor: see table below
 - Wall-mount housing: 5 kg (11 lb)

Weight (SI units)

All values (weight) refer to devices with flanges according to EN/DIN PN 40. Weight data in [lb].

Promass F / DN	8	15	25	40	50	80	100	150	250*
Compact version	11	12	14	19	30	55	96	154	400
Compact version, high-temperature	–	–	14.7	–	30.7	55.7	–	–	–
Remote version	9	10	12	17	28	53	94	152	398
Remote version, high-temperature	–	–	13.5	–	29.5	54.5	–	–	–

* With 10" according to ASME B16.5 Cl 300 flanges

Promass E / DN	8	15	25	40	50	80
Compact version	8	8	10	15	22	31
Remote version	6	6	8	13	20	29

Promass A / DN	1	2	4
Compact version	10	11	15
Remote version	8	9	13

Promass H / DN	8	15	25	40	50
Compact version	12	13	19	36	69
Remote version	10	11	17	34	67

Promass I / DN	8	15	15FB	25	25FB	40	40FB	50	50FB	80
Compact version	13	15	21	22	41	42	67	69	120	124
Remote version	11	13	19	20	38	40	65	67	118	122

"FB" = Full bore versions of Promass I

Promass S / DN	8	15	25	40	50
Compact version	13	15	21	43	80
Remote version	11	13	19	41	78

Promass P / DN	8	15	25	40	50
Compact version	13	15	21	43	80
Remote version	11	13	19	41	78

Promass O / DN ¹⁾	80	100	150
Compact version	75	141	246
Remote version	73	139	244

¹⁾ with CI 900 flanges according to ASME

Promass X / DN ¹⁾	350
Compact version	555
Remote version	553

¹⁾ with 12" according to ASME B16.5 CI 150 flanges

Weight (US units)

All values (weight) refer to devices with EN/DIN PN 40 flanges.
Weight data in [lb].

Promass F / DN	3/8"	1/2"	1"	1 1/2"	2"	3"	4"	6"	10"*
Compact version	24	26	31	42	66	121	212	340	882
Compact version, high-temperature	–	–	32	–	68	123	–	–	–
Remote version	20	22	26	37	62	117	207	335	878
Remote version, high-temperature	–	–	30	–	65	120	–	–	–

* With 10" according to ASME B16.5 CI 300 flanges

Promass E / DN	3/8"	1/2"	1	1 1/2"	2"	3"
Compact version	18	18	22	33	49	69
Remote version	13	13	18	29	44	64

Promass A / DN	1/24"	1/12"	1/8"
Compact version	22	24	33
Remote version	18	20	29

Promass H / DN	3/8"	1/2"	1	1 1/2"	2"
Compact version	26	29	42	79	152
Remote version	22	24	37	75	148

Promass I / DN	3/8"	1/2"	1/2"FB	1 1/2"	1 1/2"FB	3/8"	3/8"FB	1	1FB	2"
Compact version	29	33	46	49	90	93	148	152	265	273
Remote version	24	29	42	44	86	88	143	148	260	269

"FB" = Full bore versions of Promass I

Promass S / DN	3/8"	1/2"	1	1 ½"	2"
Compact version	29	33	46	95	176
Remote version	24	29	42	90	172

Promass P / DN	3/8"	1/2"	1	1 ½"	2"
Compact version	29	33	46	95	176
Remote version	24	29	42	90	172

Promass O / DN ¹⁾	3"	4"	6"
Compact version	165	311	542
Remote version	161	306	538

¹⁾ with Cl 900 flanges according to ASME

Promass X / DN ¹⁾	350
Compact version	1224
Remote version	1219

¹⁾ with 12" according to ASME B16.5 Cl 150 flanges

Material

Transmitter housing:

- Compact version
 - Compact version: powder coated die-cast aluminum
 - Stainless steel housing: stainless steel 1.4404/CF3M
 - Window material: glass or polycarbonate
- Remote version
 - Remote field housing: powder coated die-cast aluminum
 - Wall-mount housing: powder coated die-cast aluminum
 - Window material: glass

Sensor housing / containment:

Promass F:

- Acid- and alkali-resistant outer surface
- Stainless steel 1.4301/1.4307/304L

Promass E, A, H, I, S, P:

- Acid- and alkali-resistant outer surface
- Stainless steel 1.4301/304

Promass X, O:

- Acid- and alkali-resistant outer surface
- Stainless steel 1.4404/316L

Connection housing, sensor (remote version):

- Stainless steel 1.4301/304 (standard, not Promass X)
- Powder coated die-cast aluminum (high-temperature version and version for heating)

Process connections*Promass F:*

- Flanges according to EN 1092-1 (DIN 2501) / according to ASME B16.5 / JIS B2220
→ stainless steel 1.4404/316L
- Flanges according to EN 1092-1 (DIN 2501) / according to ASME B16.5 / JIS B2220
→ Alloy C-22 2.4602/N 06022
- DIN 11864-2 Form A (flat flange with groove) → stainless steel 1.4404/316L
- Threaded hygienic connections DIN 11851 / DIN 11864-1, Form A / ISO 2853 / SMS 1145
→ stainless steel 1.4404/316L
- Tri-Clamp (OD-tubes) → stainless steel 1.4404/316L
- VCO connection → stainless steel 1.4404/316L

Promass F (high-temperature version):

- Flanges according to EN 1092-1 (DIN 2501) / according to ASME B16.5 / JIS B2220
→ stainless steel 1.4404/316L
- Flanges according to EN 1092-1 (DIN 2501) / according to ASME B16.5 / JIS B2220
→ Alloy C-22 2.4602 (N 06022)

Promass E:

- Flanges according to EN 1092-1 (DIN 2501) / according to ASME B16.5 / JIS B2220
→ stainless steel 1.4404/316L
- DIN 11864-2 Form A (flat flange with groove) → stainless steel 1.4404/316L
- VCO connection → stainless steel 1.4404/316L
- Threaded hygienic connections DIN 11851 / DIN 11864-1, Form A / ISO 2853 / SMS 1145
→ stainless steel 1.4404/316L
- Tri-Clamp (OD-tubes) → stainless steel 1.4404/316L

Promass A:

- Mounting set for flanges EN 1092-1 (DIN 2501) / ASME B16.5 / JIS B2220
→ stainless steel 1.4539/904L, Alloy C-22 2.4602/N 06022.
Loose flanges → stainless steel 1.4404/316L
- VCO coupling → stainless steel 1.4539/904L, Alloy C-22 2.4602/N 06022
- Tri-Clamp (OD-tubes) (1/2") → stainless steel 1.4539/904L
- Mounting set for SWAGELOK (1/4", 1/8") → stainless steel 1.4401/316
- Mounting set for NPT-F (1/4") → stainless steel 1.4539/904L, 1.4539/904L,
Alloy C-22 2.4602/N 06022

Promass H:

- Flanges EN 1092-1 (DIN 2501) / according to ASME B16.5 / JIS B2220
→ stainless steel 1.4301/304, parts in contact with medium: zirconium 702/R 60702 or
tantalum 2.5W

Promass I:

- Flanges EN 1092-1 (DIN 2501) / according to ASME B16.5 / JIS B2220
→ stainless steel 1.4301/304
- DIN 11864-2 Form A (flat flange with groove) → titanium grade 2
- Threaded hygienic connection DIN 11851 / SMS 1145 → titanium grade 2
- Threaded hygienic connection ISO 2853 / DIN 11864-1 → titanium grade 2
- Tri-Clamp (OD-tubes) → titanium grade 2

Promass S:

- Flanges EN 1092-1 (DIN 2501) / JIS B2220 → stainless steel 1.4404/316/316L
- Flanges according to ASME B16.5 → stainless steel 1.4404/316/316L
- DIN 11864-2 Form A (flat flange with groove) → stainless steel 1.4435/316L
- Threaded hygienic connections DIN 11851/ DIN 11864-1, Form A / ISO 2853 / SMS 1145 → stainless steel 1.4404/316L
- Tri-Clamp (OD-Tubes) → stainless steel 1.4435/316L
- Clamp aseptic connection DIN 11864-3, Form A → stainless steel 1.4435/316L
- Clamp pipe connection DIN 32676/ISO 2852 → stainless steel 1.4435/316L

Promass P:

- Flanges EN 1092-1 (DIN 2501) / JIS B2220 → stainless steel 1.4404/316/316L
- Flanges according to ASME B16.5 → stainless steel 1.4404/316/316L
- DIN 11864-2 Form A (flat flange with groove), BioConnect® → stainless steel 1.4435/316L
- Threaded hygienic connections DIN 11851/ DIN 11864-1, Form A / ISO 2853 / SMS 1145 → stainless steel 1.4435/316L
- Tri-Clamp (OD-Tubes) → stainless steel 1.4435/316L
- Clamp aseptic connection DIN 11864-3, Form A → stainless steel 1.4435/316L
- Clamp pipe connection DIN 32676/ISO 2852, BioConnect® → stainless steel 1.4435/316L

Promass O:

- Flanges according to EN 1092-1 (DIN 2501) / according to ASME B16.5 → stainless steel 25Cr duplex F53/EN 1.4410 (superduplex)

Promass X:

- Flanges according to EN 1092-1 (DIN 2501) / according to ASME B16.5 → stainless steel 1.4404/316/316L

Measuring tube(s):*Promass F:*

- DN 8 to 100 (3/8" to 4"): stainless steel 1.4539/904L; manifold: 1.4404/316L
- DN 150 (6"): stainless steel 1.4404/316L/1.4432
- DN 250 (10"): stainless steel 1.4404/316L/1.4432; manifold: CF3M
- DN 8 to 150 (3/8" to 6"): Alloy C-22 2.4602/N 06022

Promass F (high-temperature version):

- DN 25, 50, 80 (1", 2", 3"): Alloy C-22 2.4602/N 06022

Promass E, S:

- Stainless steel 1.4539/904L

Promass A:

- Stainless steel 1.4539/904L, Alloy C-22 2.4602/N 06022

Promass H:

- Zirconium 702/R 60702
- Tantalum 2.5W

Promass I:

- Titanium grade 9
- Titanium grade 2 (flange disks)

Promass P:

Stainless steel 1.4435/316L

Promass O:

- Stainless steel 25Cr Duplex EN 1.4410/UNS S32750 (superduplex)

Promass X:

- Stainless steel 1.4404/316/316L; manifold: 1.4404/316/316L

Seals:*Promass F, E, H, I, S, P, O, X:*

Welded process connections without internal seals

Promass A:

Welded process connections without internal seals.



Only for mounting sets with threaded connections: Viton, EPDM, Silikon, Kalrez

Material load diagram	The material load diagrams (pressure-temperature diagrams) for the process connections are provided in the separate "Technical Information" document on the device in question. This can be downloaded as a PDF file from www.endress.com . A list of the "Technical Information" documents available is provided in the "Documentation" section →  147.
-----------------------	-----------------------------------------------------------------------------------------------------------------------------------------------------------------------------------------------------------------------------------------------------------------------------------------------------------------------------------------------------------------------------------------------------------------------------------------------------------------------------------

Process connections	→ Page 138 ff.
---------------------	----------------

10.1.11 Operability

Display elements	<ul style="list-style-type: none"> ■ Liquid crystal display: illuminated, four lines with 16 characters per line ■ Selectable display of different measured values and status variables ■ At ambient temperatures below -20 °C (-4 °F) the readability of the display may be impaired.
------------------	-----------------------------------------------------------------------------------------------------------------------------------------------------------------------------------------------------------------------------------------------------------------------------------------------------------------------------------------------------------------

Operating elements	<ul style="list-style-type: none"> ■ Local operation with three optical sensors (// ■ Application-specific Quick Setup menus for straightforward commissioning
--------------------	----------------------------------------------------------------------------------------------------------------------------------------------------------------------------------------------------------------------------------------------------------------------------------------------------------------------------------------------------------------------------------------------------------------------------------------------------

Language groups	<p>Language groups available for operation in different countries:</p> <ul style="list-style-type: none"> ■ Western Europe and America (WEA): English, German, Spanish, Italian, French, Dutch and Portuguese ■ Eastern Europe and Scandinavia (EES): English, Russian, Polish, Norwegian, Finnish, Swedish and Czech. ■ South and East Asia (SEA): English, Japanese, Indonesian ■ China (CN): English, Chinese
-----------------	--------------------------------------------------------------------------------------------------------------------------------------------------------------------------------------------------------------------------------------------------------------------------------------------------------------------------------------------------------------------------------------------------------------------------------------------------------------------



Note!

You can change the language group via the operating program "FieldCare".

10.1.12 Certificates and approvals

CE mark	The measuring system is in conformity with the statutory requirements of the EC Directives. Endress+Hauser confirms successful testing of the device by affixing to it the CE mark.
C-tick mark	The measuring system meets the EMC requirements of the "Australian Communications and Media Authority (ACMA)".
Ex approval	Information about currently available Ex versions (ATEX, FM, CSA, IECEx, NEPSI) can be supplied by your Endress+Hauser Sales Center on request. All explosion protection data are given in a separate documentation which is also available upon request.
Sanitary compatibility	<ul style="list-style-type: none"> ■ 3A authorization (all measuring systems, except Promass H, O and X) ■ EHEDG-tested (all measuring systems, except Promass E, H, O and X)
Certification FOUNDATION Fieldbus	<p>The flowmeter has passed all the test procedures implemented and has been certified and registered by the Fieldbus Foundation. The flowmeter thus meets all the requirements of the specifications listed below:</p> <ul style="list-style-type: none"> ■ Certified to FOUNDATION Fieldbus specification ■ The flowmeter meets all the specifications of the FOUNDATION Fieldbus-H1. ■ Interoperability Test Kit (ITK), revision 5.01: <ul style="list-style-type: none"> – The device can also be operated in conjunction with other-make certified devices. ■ Physical Layer Conformance Test by Fieldbus Foundation
Pressure measuring device approval	<p>The measuring devices can be ordered with or without PED (Pressure Equipment Directive). If a device with PED is required, this must be ordered explicitly. For devices with nominal diameters less than or equal to DN 25 (1"), this is neither possible nor necessary.</p> <ul style="list-style-type: none"> ■ With the identification PED/G1/III on the sensor nameplate, Endress+Hauser confirms conformity with the "Basic safety requirements" of Appendix I of the Pressure Equipment Directive 97/23/EC. ■ Devices with this identification (with PED) are suitable for the following types of fluid: <ul style="list-style-type: none"> – Fluids of Group 1 and 2 with a steam pressure of greater or less than 0.5 bar (7.3 psi) – Unstable gases ■ Devices without this identification (without PED) are designed and manufactured according to good engineering practice. They correspond to the requirements of Art. 3, Section 3 of the Pressure Equipment Directive 97/23/EC. Their application is illustrated in Diagrams 6 to 9 in Appendix II of the Pressure Equipment Directive 97/23/EC.
Functional safety	SIL -2: In accordance with IEC 61508/IEC 61511-1 (FDIS)

Other standards and guidelines

- EN 60529
Degrees of protection by housing (IP code).
- EN 61010-1
Protection Measures for Electrical Equipment for Measurement, Control, Regulation and Laboratory Procedures.
- IEC/EN 61326
"Emission in accordance with requirements for Class A".
Electromagnetic compatibility (EMC-requirements).
- NAMUR NE 21
Electromagnetic compatibility (EMC) of industrial process and laboratory control equipment.
- NAMUR NE 43
Standardization of the signal level for the breakdown information of digital transmitters with analog output signal.
- NAMUR NE 53
Software of field devices and signal-processing devices with digital electronics.

10.1.13 Ordering information

The Endress+Hauser service organization can provide detailed ordering information and information on specific order codes on request.

10.1.14 Accessories

Various accessories, which can be ordered separately from Endress+Hauser, are available for the transmitter and the sensor →  73.

10.1.15 Supplementary documentation

- Flow measuring technology (FA00005D)
- Description of Device Functions Promass 83
- Supplementary documentation on Ex-ratings: ATEX, FM, CSA, IECEx NEPSI
- Technical Information
 - Promass 80A, 83A (TI00054D)
 - Promass 80E, 83E (TI00061D)
 - Promass 80F, 83F (TI00101D)
 - Promass 80H, 83H (TI00074D)
 - Promass 80I, 83I (TI00075D)
 - Promass 80P, 83P (TI00078D)
 - Promass 80S, 83S (TI00076D)
 - Promass 83O (TI00112D)
 - Promass 83X (TI00110D)

Index

A

Accessories	73
Ambient temperature range	127
Applications	5
Applicator (selection and configuration software)	74
Approvals	11

C

Cable entries	
Degree of protection	33
Technical data	106
Cable specifications (remote version)	30
CE mark (declaration of conformity)	11
Certificates	11
CFF file	43
CIP cleaning	72
Cleaning	
CIP cleaning	72, 127
Exterior cleaning	72
SIP cleaning	72
Code entry (function matrix)	41
Commissioning	
Quick Setup "Commissioning"	53
Zero point adjustment	64
CommuBox FXA193	43
Connection	
See Electrical connection	
C-tick mark	11
Current output	
Technical data	102

D

Data backup	56
Declaration of conformity (CE mark)	11
Degree of protection	33, 127
Designated use	5
Device description files	43
Device designation	7
Device functions	
See "Description of Device Functions" manual	
Display	
Local display	36
Turning the display	25
Disposal	96

E

Electrical connection	
Cable specifications (FOUNDATION Fieldbus)	26
Cable specifications (remote version)	30
Degree of protection	33
Error messages	
Confirming error messages	42
Process errors (device errors)	87
System errors (device errors)	79–80
Error types (system and process errors)	42, 79
European Pressure Equipment Directive	146
Ex approval	146

Exterior cleaning	72
-------------------	----

F

F-Chip	71
FieldCare	43
FieldCheck (tester and simulator)	74
Flow direction	16–17
FOUNDATION Fieldbus	
configuration programs	43
Device certification	11
Hardware write protection	45
Terminal assignment	30
Function check	46
Function descriptions	
See "Description of Device Functions" manual	
Functions	40
Fuse, replacing	95
FXA193	74

G

Galvanic isolation	102
--------------------	-----

H

Hardware write protection	
FOUNDATION Fieldbus	45
Hazardous substances	96
HOME position (operating mode)	36

I

Incoming acceptance	12
Inlet run	127
Inlet runs	21
Installation	
See Installation conditions	
Installation conditions	
Dimensions	14
Inlet and outlet runs	21
Mounting location	14
Orientation (vertical, horizontal)	16
System pressure	15
Vertical pipe	15
Vibrations	21
Installation instructions	127
Special instructions for Promass F, E, H, P and S	18
Special instructions for Promass I and P with Eccentric Tri-clamps	18
Special instructions for Promass I and P with hygienic connections	19
Installing the wall-mount housing	23
Insulation of sensors	21

J

Jumper	45
--------	----

L

Language groups	145
Length of connecting cable	127

- Life Cycle Management 74
- Limiting flow
 - See Measuring range
- Local display
 - See Display
- M**
- Maintenance 72
- Material 142
- Material load diagram 129, 145
- Measured variables 99
- Measuring principle 99
- Measuring range 99–101
- Measuring system 7
- Medium pressure range 129
- Medium temperature range 128
- N**
- Nameplate
 - Connections 10
 - Sensor 9
- Nominal pressure
 - See Medium pressure range
- O**
- Operable flow range 101
- Operating conditions 127
- Operation
 - FieldCare 43
 - FOUNDATION Fieldbus configuration programs 43
 - Function matrix 40
- Operational safety 6
- Ordering code
 - Accessories 73
- Ordering information 147
- Outlet run 127
- Outlet runs 21
- Output signal 102
- P**
- Performance characteristic
 - Promass A 107
 - Promass E 109
 - Promass F 111, 125
 - Promass H 114
 - Promass I 116
 - Promass O 118
 - Promass P 121
 - Promass S 123
- Post-installation check (checklist) 25
- Power consumption 106
- Power supply (supply voltage) 106
- Power supply failure 106
- Pressure loss 139
- Pressure loss (formulas, pressure loss diagrams) 130
- Pressure measuring device approval 146
- Pressure monitoring connections 70
- Process connections 145
- Process error
 - Definition 42
- Process error messages 87
- Programming mode
 - Disabling 42
 - Enabling 41
- Pumps, mounting location, system pressure 15
- Purge connections 70
- Q**
- Quick Setup
 - Commissioning 53
- R**
- Reference operating conditions 107
- Registered trademarks 11
- Repair 96
- Replacement
 - Seals 72
- Returning devices 96
- S**
- Safety icons 6
- Safety instructions 6
- Sanitary compatibility 146
- S-DAT (HistoROM) 71
- Seals
 - Material 145
 - Medium temperature range 128
 - Replacing, replacement seals 72
- Secondary containment
 - Gas purging, pressure monitoring connections 70
 - Pressure range 129
- Sensor heating 20
- Sensor mounting
 - See Sensor installation
- Service interface
 - Commubox FXA193 43
 - Commubox FXA291 74
- SIL (functional safety) 6, 146
- SIP cleaning 72
- Software
 - Amplifier display 46
- Spare parts 90
- Standards, guidelines 146
- Storage 13
- Supplementary Ex documentation 6
- Supply voltage (power supply) 106
- System error
 - Definition 42
 - System error messages 79
- System error messages 80
- System files 43
- T**
- T-DAT
 - Save/load (data backup, device replacement) 56
- T-DAT (HistoROM) 71
- Technical data at a glance 99
- Temperature ranges
 - Ambient temperature range 127
 - Medium temperature range 128

Storage temperature.....	127
Terminal assignment	
FOUNDATION Fieldbus	30
Thermal insulation, general notes	21
Transmitter	
Installing the wall-mount housing	23
Turning the field housing (aluminum)	22
Turning the field housing (stainless steel)	22
Transporting the sensor	12
Troubleshooting and remedy	75
V	
Vertical pipe	15
Vibration resistance	127
Vibrations	21, 127
W	
W@M.....	74
Wall-mount housing, installing	23
Weight	140
Wiring	
See Electrical connection	
Write protection	45
Z	
Zero point adjustment	64

Declaration of Hazardous Material and De-Contamination *Erklärung zur Kontamination und Reinigung*

RA No.

Please reference the Return Authorization Number (RA#), obtained from Endress+Hauser, on all paperwork and mark the RA# clearly on the outside of the box. If this procedure is not followed, it may result in the refusal of the package at our facility.
Bitte geben Sie die von E+H mitgeteilte Rücklieferungsnummer (RA#) auf allen Lieferpapieren an und vermerken Sie diese auch außen auf der Verpackung. Nichtbeachtung dieser Anweisung führt zur Ablehnung ihrer Lieferung.

Because of legal regulations and for the safety of our employees and operating equipment, we need the "Declaration of Hazardous Material and De-Contamination", with your signature, before your order can be handled. Please make absolutely sure to attach it to the outside of the packaging.

Aufgrund der gesetzlichen Vorschriften und zum Schutz unserer Mitarbeiter und Betriebseinrichtungen, benötigen wir die unterschriebene "Erklärung zur Kontamination und Reinigung", bevor Ihr Auftrag bearbeitet werden kann. Bringen Sie diese unbedingt außen an der Verpackung an.

Type of instrument / sensor
Geräte-/Sensortyp _____

Serial number
Seriennummer _____

Used as SIL device in a Safety Instrumented System / Einsatz als SIL Gerät in Schutzeinrichtungen

Process data / Prozessdaten
Temperature / *Temperatur* _____ [°F] _____ [°C] Pressure / *Druck* _____ [psi] _____ [Pa]
Conductivity / *Leitfähigkeit* _____ [µS/cm] Viscosity / *Viskosität* _____ [cp] _____ [mm²/s]

Medium and warnings
Warnhinweise zum Medium



	Medium / concentration <i>Medium / Konzentration</i>	Identification CAS No.	flammable <i>entzündlich</i>	toxic <i>giftig</i>	corrosive <i>ätzend</i>	harmful/ irritant <i>gesundheitsschädlich/ reizend</i>	other * <i>sonstiges*</i>	harmless <i>unbedenklich</i>
Process medium <i>Medium im Prozess</i>								
Medium for process cleaning <i>Medium zur Prozessreinigung</i>								
Returned part cleaned with <i>Medium zur Endreinigung</i>								

* explosive; oxidizing; dangerous for the environment; biological risk; radioactive

* *explosiv; brandfördernd; umweltgefährlich; biogefährlich; radioaktiv*

Please tick should one of the above be applicable, include safety data sheet and, if necessary, special handling instructions.

Zutreffendes ankreuzen; trifft einer der Warnhinweise zu, Sicherheitsdatenblatt und ggf. spezielle Handhabungsvorschriften beilegen.

Description of failure / Fehlerbeschreibung _____

Company data / Angaben zum Absender

Company / <i>Firma</i> _____	Phone number of contact person / <i>Telefon-Nr. Ansprechpartner:</i> _____
Address / <i>Adresse</i> _____	Fax / E-Mail _____
Your order No. / <i>Ihre Auftragsnr.</i> _____	

"We hereby certify that this declaration is filled out truthfully and completely to the best of our knowledge. We further certify that the returned parts have been carefully cleaned. To the best of our knowledge they are free of any residues in dangerous quantities."

"Wir bestätigen, die vorliegende Erklärung nach unserem besten Wissen wahrheitsgetreu und vollständig ausgefüllt zu haben. Wir bestätigen weiter, dass die zurückgesandten Teile sorgfältig gereinigt wurden und nach unserem besten Wissen frei von Rückständen in gefahrbringender Menge sind."

(place, date / Ort, Datum)

Name, dept./Abt. (please print / bitte Druckschrift)

Signature / Unterschrift

www.endress.com/worldwide

Endress + Hauser 
People for Process Automation
