

valid as of:
software version 2.70

Operating Instructions

Liquisys M CPM223/253

Transmitter for pH and ORP

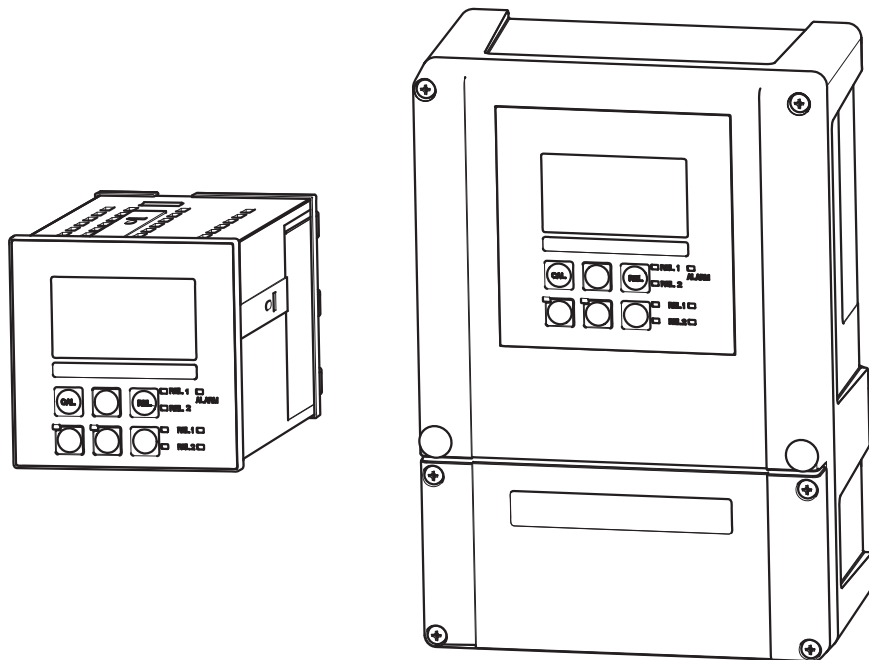

About this document

Safety messages

The structure, signal words and safety colors of the signs comply with the specifications of ANSI Z535.6 ("Product safety information in product manuals, instructions and other collateral materials").

Safety message structure	Meaning
⚠ DANGER Cause (/consequences) Consequences if safety message is not heeded ▶ Corrective action	This symbol alerts you to a dangerous situation. Failure to avoid the situation will result in a fatal or serious injury.
⚠ WARNING Cause (/consequences) Consequences if safety message is not heeded ▶ Corrective action	This symbol alerts you to a dangerous situation. Failure to avoid the situation can result in a fatal or serious injury.
⚠ CAUTION Cause (/consequences) Consequences if safety message is not heeded ▶ Corrective action	This symbol alerts you to a dangerous situation. Failure to avoid this situation can result in minor or medium injury.
NOTICE Cause/situation Consequences if safety message is not heeded ▶ Action/note	This symbol alerts you to situations that can result in damage to property and equipment.

Symbols



-  Additional information, tips
-  Permitted or recommended
-  Forbidden or not recommended

Table of contents

1	Basic safety instructions	5	5	Operability	29
1.1	Requirements for the personnel	5	5.1	Quick operation guide	29
1.2	Designated use	5	5.2	Display and operating elements	29
1.3	Workplace safety	5	5.2.1	Display	29
1.4	Operational safety	5	5.2.2	Operating elements	30
1.5	Product safety	6	5.2.3	Key assignment	31
1.6	Electrical symbols	6	5.3	Local Operation	33
2	Incoming acceptance and product identification	7	5.3.1	Automatic/manual mode	33
2.1	Incoming acceptance	7	5.3.2	Operating concept	34
2.2	Scope of delivery	7	6	Commissioning	36
2.3	Product identification	8	6.1	Things to note when commissioning digital sensors	36
2.3.1	Nameplate	8	6.2	Things to note when commissioning ISFET sensors	36
2.3.2	Identifying the product	8	6.3	Function check	36
2.4	Certificates and approvals	8	6.4	Switching on	37
2.4.1	CE mark	8	6.5	Quick start-up	39
2.4.2	CSA general purpose	8	6.6	System configuration	41
3	Installation	9	6.6.1	Setup 1 (pH / ORP)	41
3.1	Quick installation guide	9	6.6.2	Setup 2 (temperature)	43
3.1.1	Measuring system	9	6.6.3	Current input	44
3.2	Installation conditions	10	6.6.4	Current outputs	47
3.2.1	Field instrument	10	6.6.5	Monitoring functions	51
3.2.2	Panel-mounted instrument	11	6.6.6	Relay contact configuration	56
3.3	Installation instructions	12	6.6.7	Service	69
3.3.1	Field instrument	12	6.6.8	E+H Service	71
3.3.2	Panel-mounted instrument	15	6.6.9	Interfaces	72
3.4	Post-installation check	15	6.7	Communication	72
4	Electrical connection	16	6.8	Calibration	73
4.1	Wiring	16	7	Diagnostics and troubleshooting	79
4.2	Electrical connection without Memosens functionality	17	7.1	Troubleshooting instructions	79
4.2.1	Connection diagram	17	7.2	System error messages	79
4.2.2	Measuring cable and sensor connection	20	7.3	Process specific errors	83
4.3	Electrical connection with Memosens functionality	24	7.4	Instrument specific errors	86
4.3.1	Connection diagram	24	8	Maintenance	88
4.3.2	Measuring cable and sensor connection	26	8.1	Maintenance of the entire measuring point	88
4.4	Alarm contact	28	8.1.1	Cleaning the transmitter	88
4.5	Post-connection check	28	8.1.2	Cleaning the pH/ORP sensors	89
			8.1.3	Maintaining digital sensors	90
			8.1.4	Liquid KCl supply	90
			8.1.5	Assembly	90
			8.1.6	Connecting lines and junction boxes	91
			9	Repair	92
			9.1	Spare parts	92
			9.2	Dismantling the panel-mounted instrument	92
			9.3	Dismantling the field instrument	95
			9.4	Replacing the central module	98
			9.5	Return	99
			9.6	Disposal	99

10	Accessories	100
10.1	Sensors	100
10.2	Connection accessories	102
10.3	Mounting accessories	103
10.4	Software and hardware add-ons	104
10.5	Calibration solutions	105
11	Technical data	106
11.1	Input	106
11.2	Output	106
11.3	Power supply	109
11.4	Performance characteristics	110
11.5	Environment	111
11.6	Mechanical construction	111
12	Appendix	112
	Index	117

1 Basic safety instructions

1.1 Requirements for the personnel

- ▶ Installation, commissioning, operation and maintenance of the measuring system must only be carried out by trained technical personnel.
 - ▶ The technical personnel must be authorized by the plant operator to carry out the specified activities.
 - ▶ The electrical connection may only be performed by an electrical technician.
 - ▶ The technical personnel must have read and understood these Operating Instructions and must follow the instructions they contain.
 - ▶ Measuring point faults may only be rectified by authorized and specially trained personnel.
-  Repairs not described in the enclosed Operating Instructions may only be carried out directly at the manufacturer's or by the service organization.

1.2 Designated use

Liquisys M is a transmitter for determining the pH value and/or the ORP.

The transmitter is particularly suited for use in the following areas:

- Chemical industry
- Pharmaceutical industry
- Food industry
- Drinking water treatment
- Condensate treatment
- Municipal sewage treatment plants
- Water treatment
- Electroplating

Any other use than the one described here compromises the safety of persons and the entire measuring system and is not permitted.

The manufacturer is not liable for damage caused by improper or non-designated use.

1.3 Workplace safety

As the user, you are responsible for complying with the following safety conditions:

- Regulations for explosion protection
- Installation instructions
- Local standards and regulations

Electromagnetic compatibility

With regard to electromagnetic compatibility, this device has been tested in accordance with the applicable European standards for industrial applications.

The electromagnetic compatibility indicated only applies to a device that has been connected in accordance with the instructions in these Operating Instructions.

1.4 Operational safety

- ▶ Before commissioning the entire measuring point, make sure all the connections are correct. Ensure that electrical cables and hose connections are not damaged.
- ▶ Do not operate damaged products, and safeguard them to ensure that they are not operated inadvertently. Mark the damaged product as defective.
- ▶ If faults cannot be rectified, the products must be taken out of service and secured against unintentional commissioning.

1.5 Product safety

The product is designed to meet state-of-the-art safety requirements, has been tested and left the factory in a condition in which it is safe to operate. Relevant regulations and European standards have been observed.

1.6 Electrical symbols



Direct Current (DC)

A terminal at which DC is applied or through which DC flows.



Alternating Current (AC)

A terminal at which (sine-form) AC is applied or through which AC flows.



Ground connecting

A terminal which, from the user's point of view, is already grounded using a grounding system.



Protective ground terminal

A terminal which must be grounded before other connections may be set up.



Class II (isolated) device

Double insulation



Alarm relay



Input



Output



DC voltage source



Temperature sensor

2 Incoming acceptance and product identification

2.1 Incoming acceptance

- ▶ Make sure the packaging is undamaged!
- ▶ Inform the supplier about any damage to the packaging.
Keep the damaged packaging until the matter has been settled.
- ▶ Make sure the contents are undamaged!
- ▶ Inform the supplier about damage to the contents. Keep the damaged products until the matter has been settled.
- ▶ Check that the order is complete and agrees with your shipping documents.
- ▶ The packaging material used to store or to transport the product must provide shock protection and humidity protection. The original packaging offers the best protection. Also, keep to the approved ambient conditions (see "Technical data").
- ▶ If you have any questions, please contact your supplier or your local sales center.

2.2 Scope of delivery

The delivery of the field instrument includes:

- 1 transmitter CPM253
- 1 plug-in screw terminal
- 1 cable gland Pg 7
- 1 cable gland Pg 16 reduced
- 2 cable glands Pg 13.5
- 1 Operating Instructions BA00194C/07/EN
- 1 Operating Instructions
 - versions with HART communication:
 - 1 Operating Instructions Field Communication with HART, BA00208C/07/EN
 - versions with PROFIBUS communication:
 - 1 Operating Instructions Field Communication with PROFIBUS PA/DP, BA00209C/07/EN

The delivery of the panel mounted instrument includes:

- 1 transmitter CPM223
- 1 set of plug-in screw terminals
- 2 tensioning screws
- 1 BNC-plug (solder-free)
- 1 Operating Instructions BA00194C/07/EN
- 1 Operating Instructions
 - versions with HART communication:
 - 1 Operating Instructions Field Communication with HART, BA00208C/07/EN
 - versions with PROFIBUS communication:
 - 1 Operating Instructions Field Communication with PROFIBUS PA/DP, BA00209C/07/EN

If you have any questions, please contact your supplier or your sales centre responsible.

2.3 Product identification

2.3.1 Nameplate

The nameplate contains the following information:

- Manufacturer data
- Order code
- Extended order code
- Serial number
- Operating conditions
- Safety icons

Compare the order code on the nameplate with your order.

2.3.2 Identifying the product

The order code and serial number of your device can be found in the following locations:

- On the nameplate
- In the delivery papers

 To find out the version of your device, enter the order code indicated on the nameplate in the search screen at the following address: www.products.endress.com/order-ident

2.4 Certificates and approvals

2.4.1 CE mark

Declaration of conformity

The product meets the requirements of the harmonized European standards. It thus complies with the legal requirements of the EC directives.

The manufacturer confirms successful testing of the product by affixing the **CE** symbol.

2.4.2 CSA general purpose

CSA General Purpose

The products listed below are eligible to bear the CSA Mark shown with adjacent indicators "C" and "US":

Version	Approval
CPM253-..2... CPM253-..3... CPM253-..7...	CSA Mark for Canada and USA
CPM223-..2... CPM223-..3... CPM223-..7...	CSA Mark for Canada and USA

3 Installation

3.1 Quick installation guide

Proceed as follows to completely install the measuring point:

- Install the transmitter (see "Installation instructions" section).
- If the sensor is not yet installed in the measuring point, install it (see Technical Information of the sensor).
- Connect the sensor to the transmitter as illustrated in the "Electrical connection" section.
- Connect the transmitter as illustrated in the "Electrical connection" section.
- Commission the transmitter as explained in the "Commissioning" section.

3.1.1 Measuring system

A complete measuring systems comprises:

- The transmitter Liquisys M CPM223 or CPM253
- A pH/ORP electrode with or without an integrated temperature sensor
- An immersible, flow or retractable assembly
- A measuring cable(e.g. CPK9)

Options: extension cable, junction box VBA or VBM

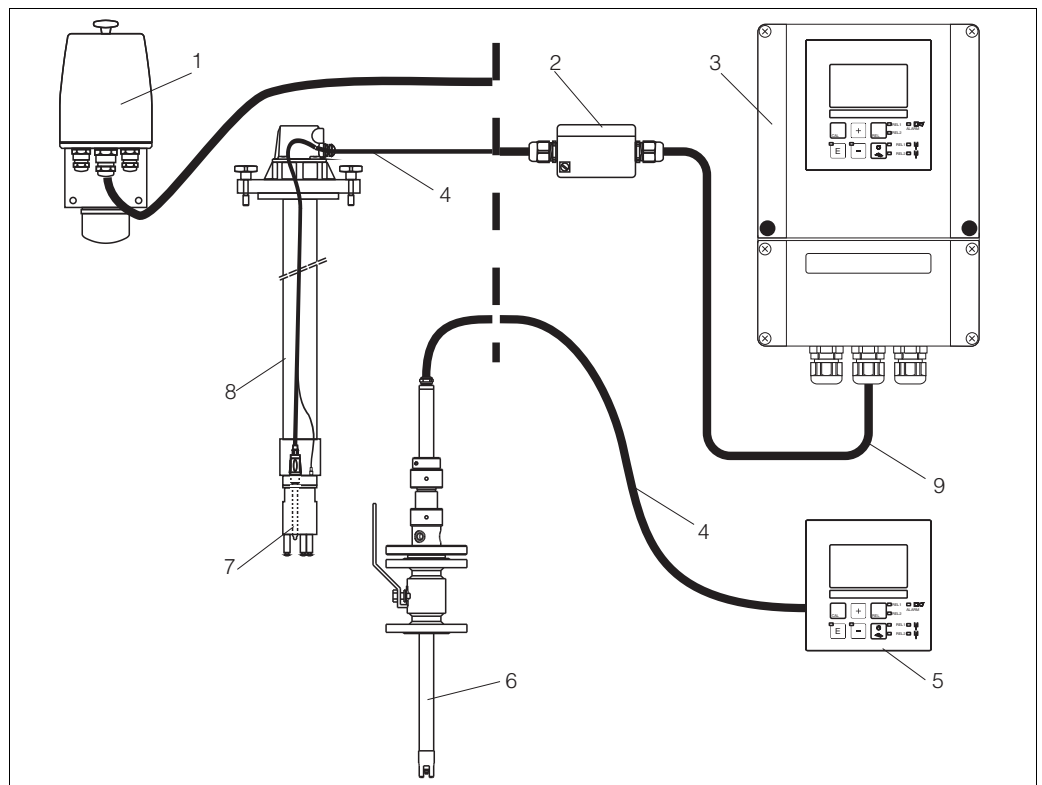

Fig. 1: Complete measuring system Liquisys M CPM223/253

1 Flow assembly CPA250

2 Junction box VBA

3 Liquisys M CPM253

4 Measuring cable e.g. CPK9

5 Liquisys M CPM223

6 Retractable assembly Cleanfit W CPA450

7 Electrode, e.g. Orbisint CPS11

8 Immersion assembly CPA111

9 Extension cable

a0007781

3.2 Installation conditions

3.2.1 Field instrument

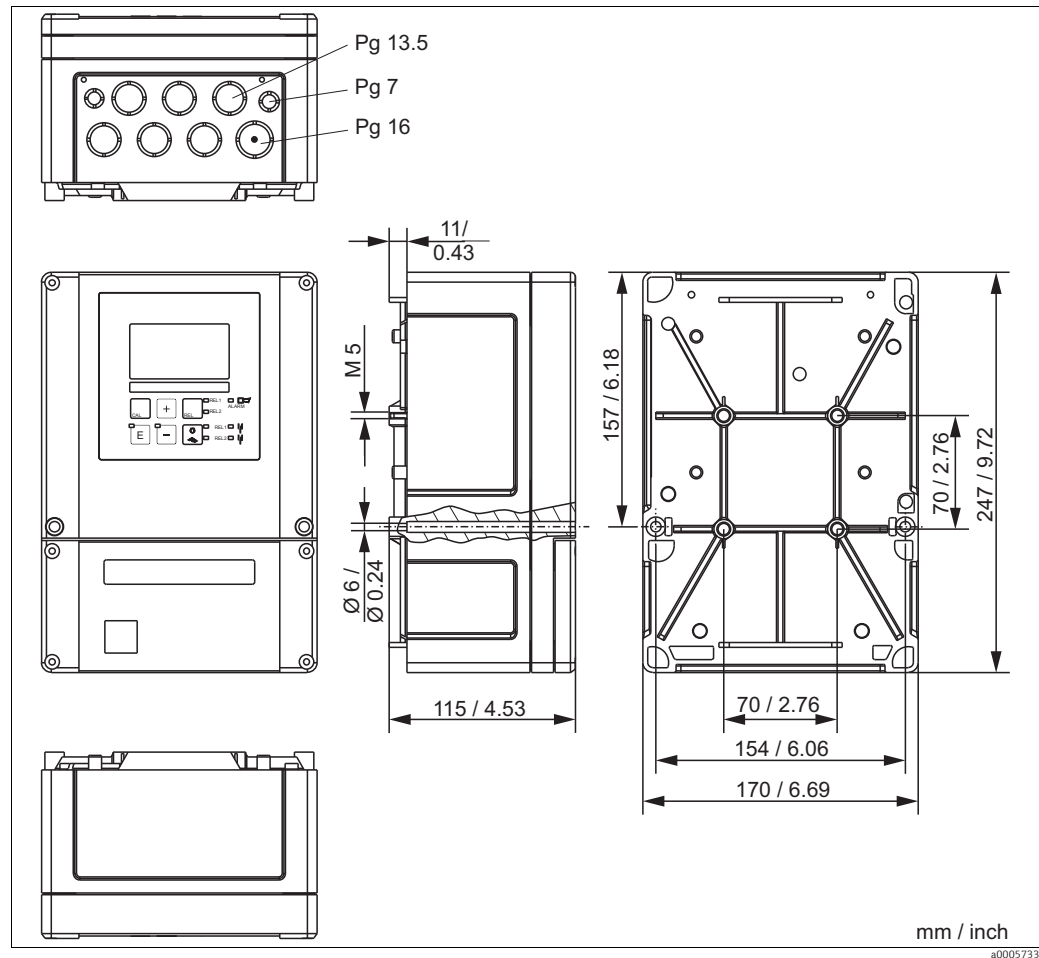
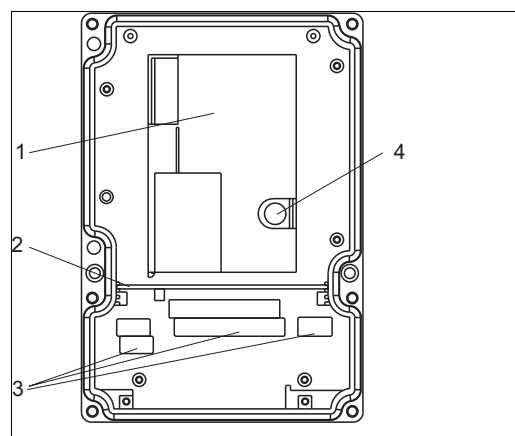

Fig. 2: Field instrument

i There is a hole in the punching for the cable entry (connection of supply voltage). It serves as a pressure balance during air freight dispatching. Make sure no moisture penetrates the inside of the housing before the cable installation. The housing is completely air-tight after the cable installation.



- 1 Removable electronics box
- 2 Partition plate
- 3 Terminals
- 4 Fuse

Fig. 3: View into the field housing

3.2.2 Panel-mounted instrument

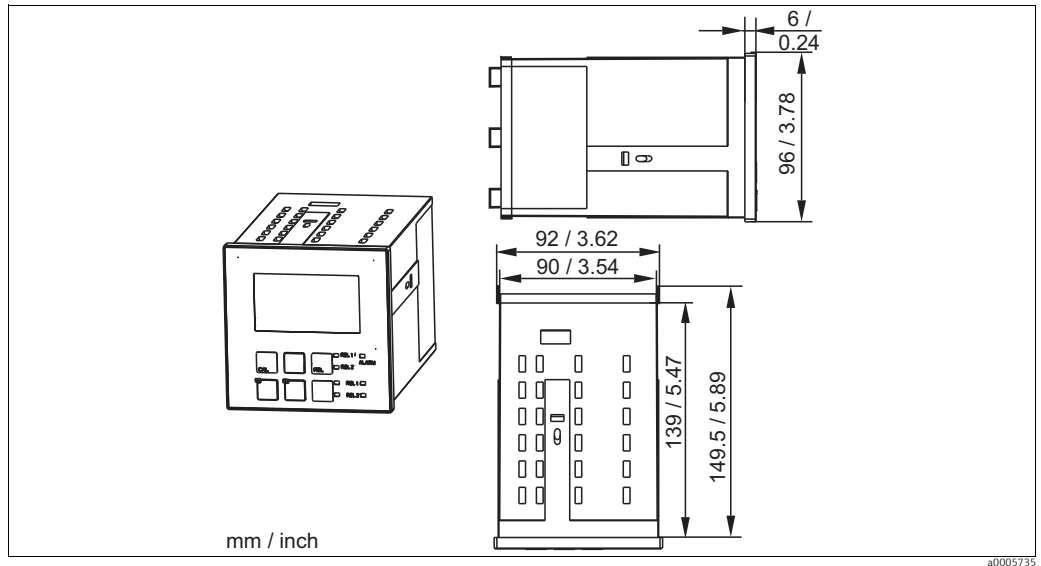

Fig. 4: Panel-mounted instrument

3.3 Installation instructions

3.3.1 Field instrument

There are several ways of securing the field housing:

- Wall mounting with fixing screws
- Post mounting to cylindrical pipes
- Post mounting to square securing masts

NOTICE

Effect of climate conditions (rain, snow, direct sun etc.)

Impaired operation to complete transmitter failure

- ▶ When installing outside, always use the weather protection cover (accessory).

Transmitter wall mounting

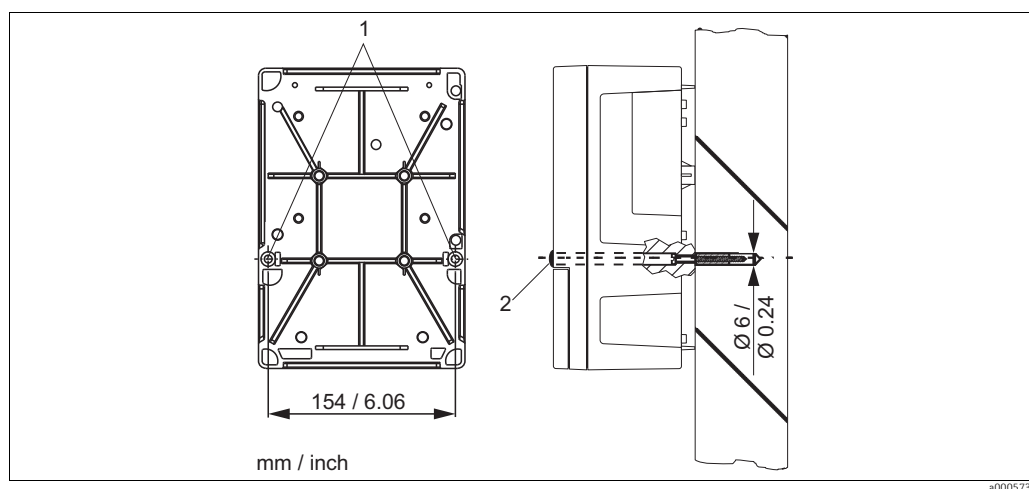



Fig. 5: Wall mounting field device

For wall mounting the transmitter, proceed as follows:

1. Drill the bores as shown in →  5.
2. Drive the two fixing screws through the securing bores (1) from the front.
3. Mount the transmitter on the wall as shown.
4. Cover the bores with plastic caps (2).

Transmitter post mounting

- i** You require a post mounting kit to secure the field device to horizontal and vertical posts or pipes (max. \varnothing 60 mm (2.36")). The kit can be acquired as an accessory (see "Accessories" section).

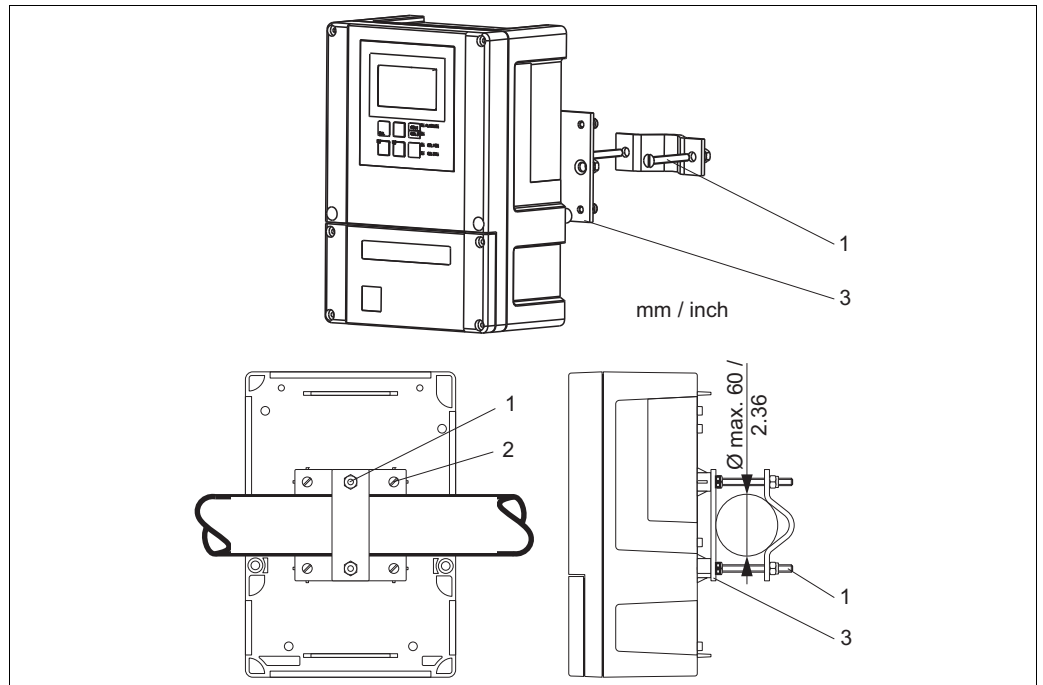

Fig. 6: Post mounting field device to cylindrical pipes

For post mounting the transmitter, proceed as follows:

1. Guide the two securing screws (1) of the mounting kit through the openings of the securing plate (3).
2. Screw the securing plate onto the transmitter using the four fixing screws (2).
3. Secure the retainer with the field device on the post or pipe using the clip.

You can also secure the field device to a square universal post in conjunction with the weather protection cover. These can be acquired as accessories, see "Accessories" section.

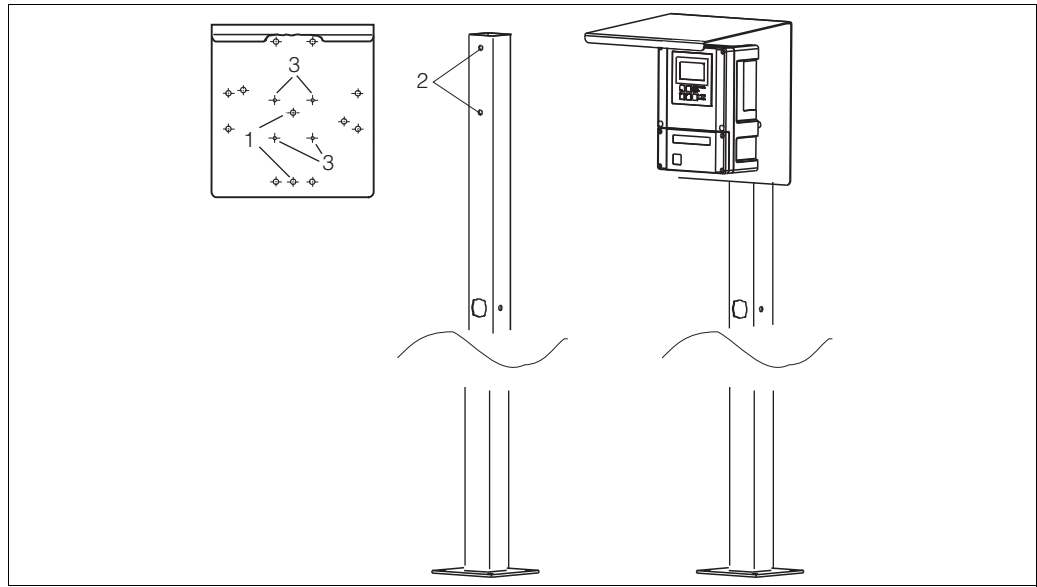



Fig. 7: Mounting field device with universal posts and weather protection cover

For mounting the weather protection cover, proceed as follows:

1. Screw the weather protection cover with 2 screws (bores 1) to the upright post (bores 2).
2. Secure the field device to the weather protection cover. To do so, use the bores (3).

3.3.2 Panel-mounted instrument

The panel-mounted instrument is secured with the clamping screws supplied (see →  8). The necessary installation depth is approx. 165 mm (6.50").

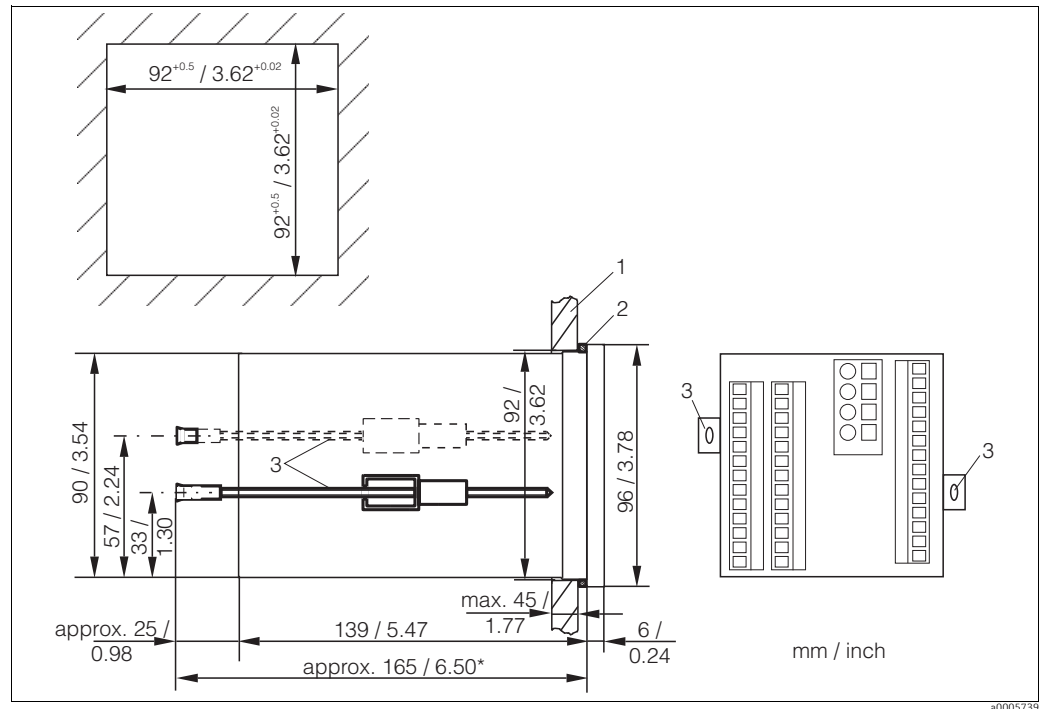

Fig. 8: Securing the panel-mounted instrument

- 1 Wall of the cabinet
- 2 Seal
- 3 Clamping screws
- * Required installation depth

3.4 Post-installation check

- After installation, check the transmitter for damage.
- Check whether the transmitter is protected against moisture and direct sunlight (e.g. by the weather protection cover).

4 Electrical connection

⚠ WARNING

Device is energized

Improper connection can cause injury or death.

- ▶ The electrical connection must only be carried out by a certified electrician.
- ▶ Technical personnel must have read and understood the instructions in this manual and must adhere to them.
- ▶ **Prior to beginning** any wiring work, make sure voltage is not applied to any of the cables.

4.1 Wiring

NOTICE

The device does not have a power switch

- ▶ You must provide a protected circuit breaker in the vicinity of the device.
- ▶ This must be a switch or a power-circuit breaker and you must label it as the circuit breaker for the device.
- ▶ At the supply point, the power supply for the 24 V versions must be isolated from dangerous live cables by double or reinforced insulation.

The electrical connection of the transmitter differs depending on the device version:

- If you are using a device without Memosens functionality, please read the instructions in the "Electrical connection without Memosens functionality" section.
- If you are using a device with Memosens functionality, please read the instructions in the "Electrical connection with Memosens functionality" section.

4.2 Electrical connection without Memosens functionality

4.2.1 Connection diagram

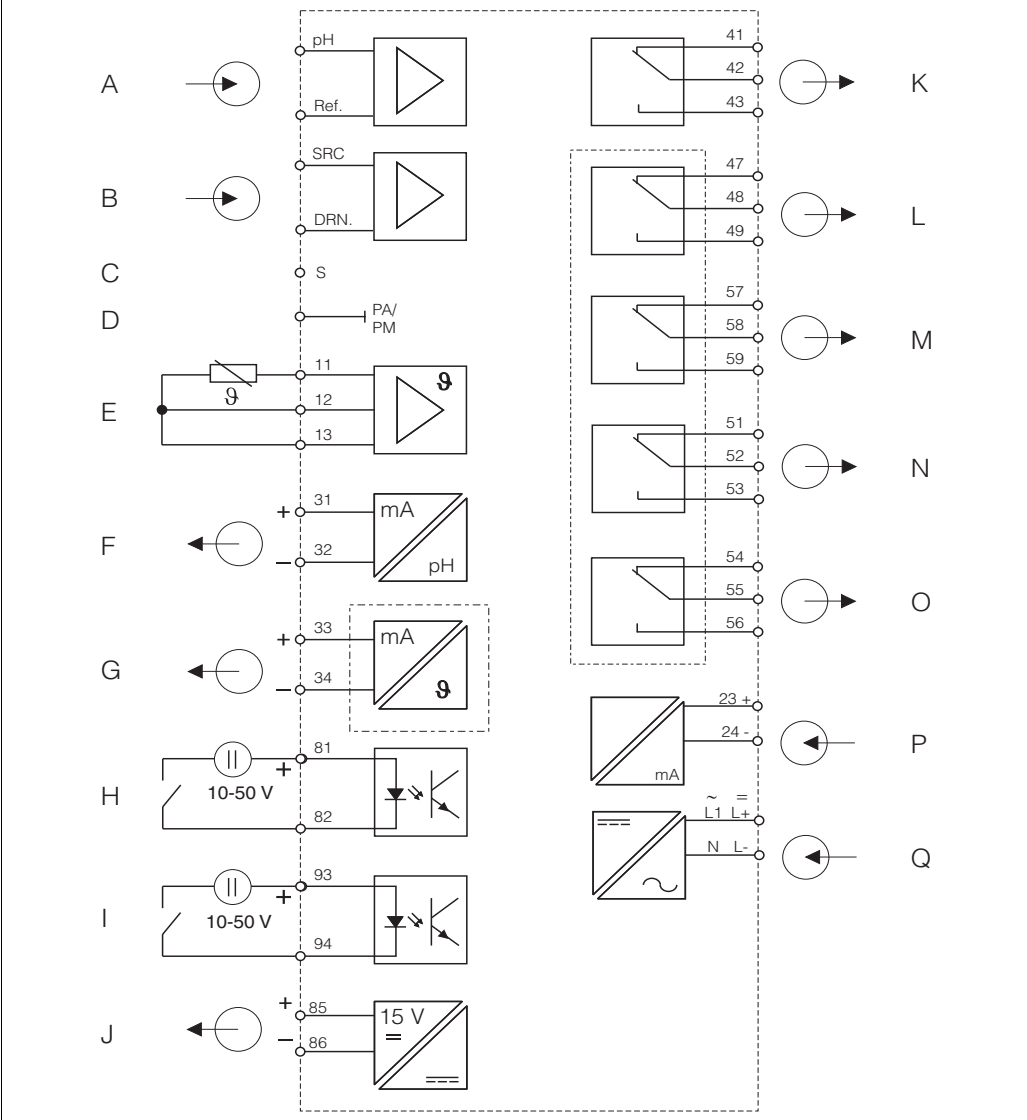
The wiring diagram depicted in →  9 shows the connections of an instrument equipped with all the options. Connecting the sensors to the various measuring cables is explained in more detail in the "Measuring cables and sensor connection" section.

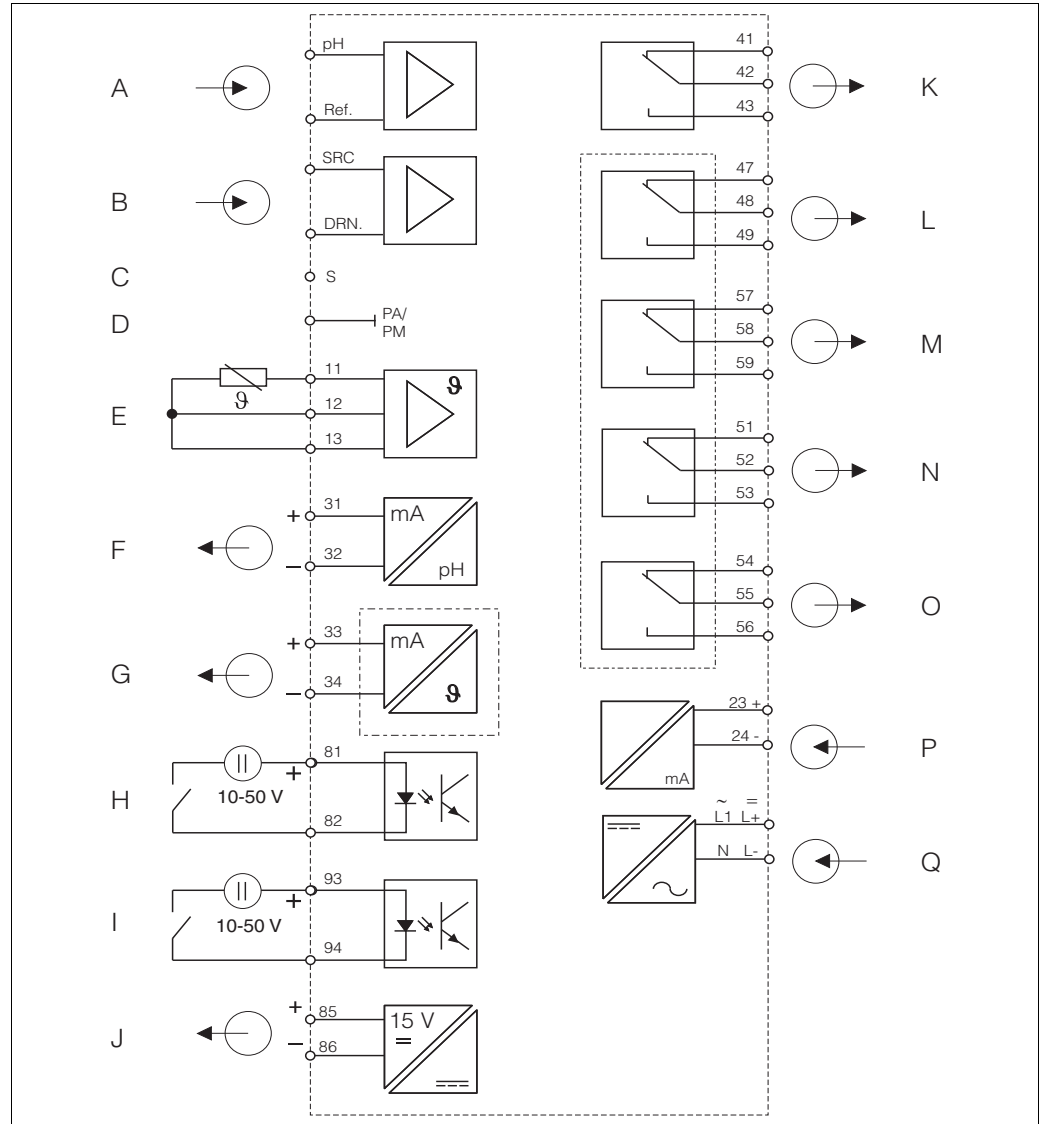

Fig. 9: Transmitter electrical connection without Memosens functionality

- | | | | |
|---|---|---|--|
| A | Standard sensor | J | Auxiliary voltage output |
| B | ISFET sensor | K | Alarm (contact position currentless) |
| C | Outer screen connection for glass electrodes | L | Relay 1 (contact position currentless) |
| D | Potential matching | M | Relay 2 (contact position currentless) |
| E | Temperature sensor | N | Relay 3 (contact position currentless) |
| F | Signal output 1 pH/ORP | O | Relay 4 (contact position currentless) |
| G | Signal output 2 temperature, pH/ORP or controller | P | Current input 4 ... 20 mA |
| H | Binary input 1 (Hold) | Q | Power supply |
| I | Binary input 2 (Chemoclean) | | |

Pay attention to the following:

- The device is approved for protection class II and is generally operated without a protective earth connection.
- To guarantee measuring stability and functional safety, you have to ground the outer screen of the sensor cable:
 - Glass electrodes (PR/PS device version): terminal "S"
 - ISFET sensors (IS device version): PE distributor rail
 This is on the cover frame for panel-mounted instruments and in the connection compartment for field devices.
- Ground the PE distributor rail or the ground terminal.

Field instrument connection

Guide the measuring cables through the PG glands into the housing. Connect the measuring cables in accordance with the terminal assignment (→  10).

NOTICE

Nonobservance could cause incorrect measurement

- ▶ Make sure to protect the connectors, cable ends and terminals against moisture.
- ▶ Terminals marked NC may not be wired.
- ▶ Unmarked terminals may not be wired.

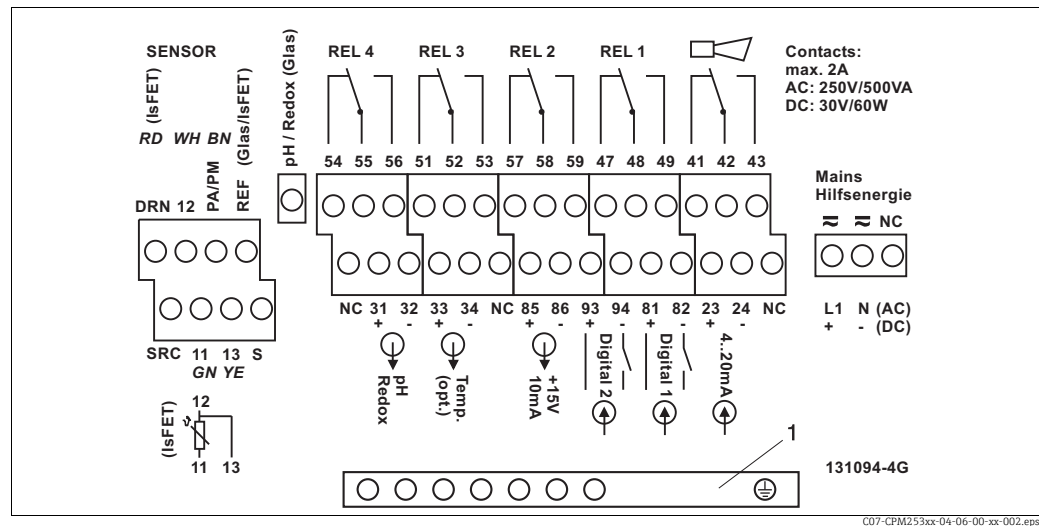

Fig. 10: Field instrument connection compartment sticker

1 PE distributor rail for IS device version

Panel-mounted instrument connection

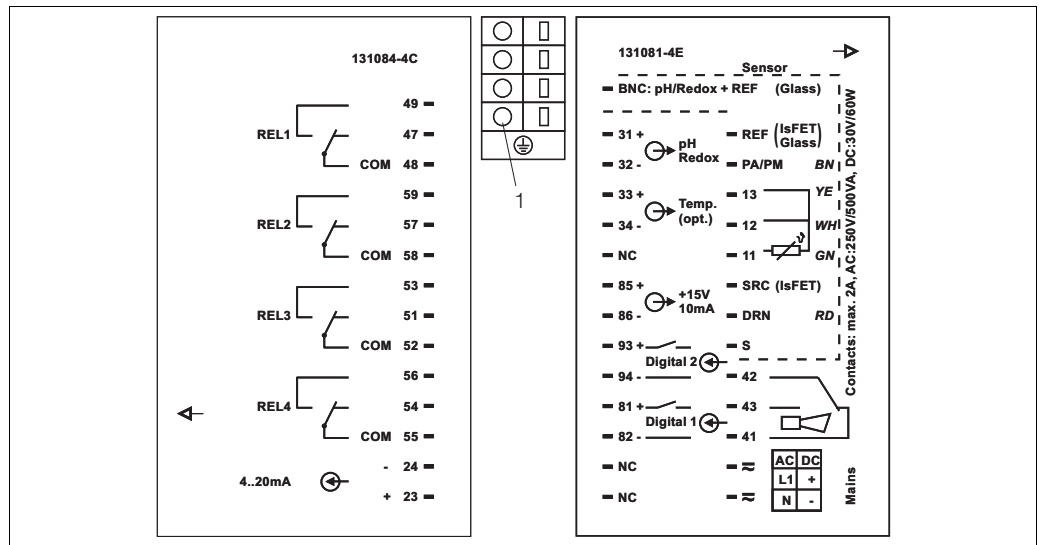

Fig. 11: Panel-mounted instrument connection sticker

1 Ground terminal for IS device version

NOTICE

Nonobservance could cause incorrect measurement

- ▶ Make sure to protect the connectors, cable ends and terminals against moisture.
- ▶ Terminals marked NC may not be wired.
- ▶ Unmarked terminals may not be wired.

Please label the sensor terminal block with the sticker provided.

4.2.2 Measuring cable and sensor connection

You require screened special measuring cables to connect pH and ORP electrodes to the transmitter. The following multi-core and ready-to-use cable types can be used:

Sensor type	Cable	Extension
Electrode without temperature sensor	CPK1	VBA / VBM box + CYK71 cable
Electrode with temperature sensor Pt 100 and TOP 68 plug-in head	CPK9	VBA / VBM box + CYK71 cable
ISFET sensor with temperature sensor Pt 100 / Pt 1000 and TOP 68 plug-in head	CPK12	VBA / VBM box + CYK12 cable
pH individual electrode with separate reference electrode and separate temperature sensor	CPK2	VBA / VBM box + PMK cable

Structure and termination of the measuring cables

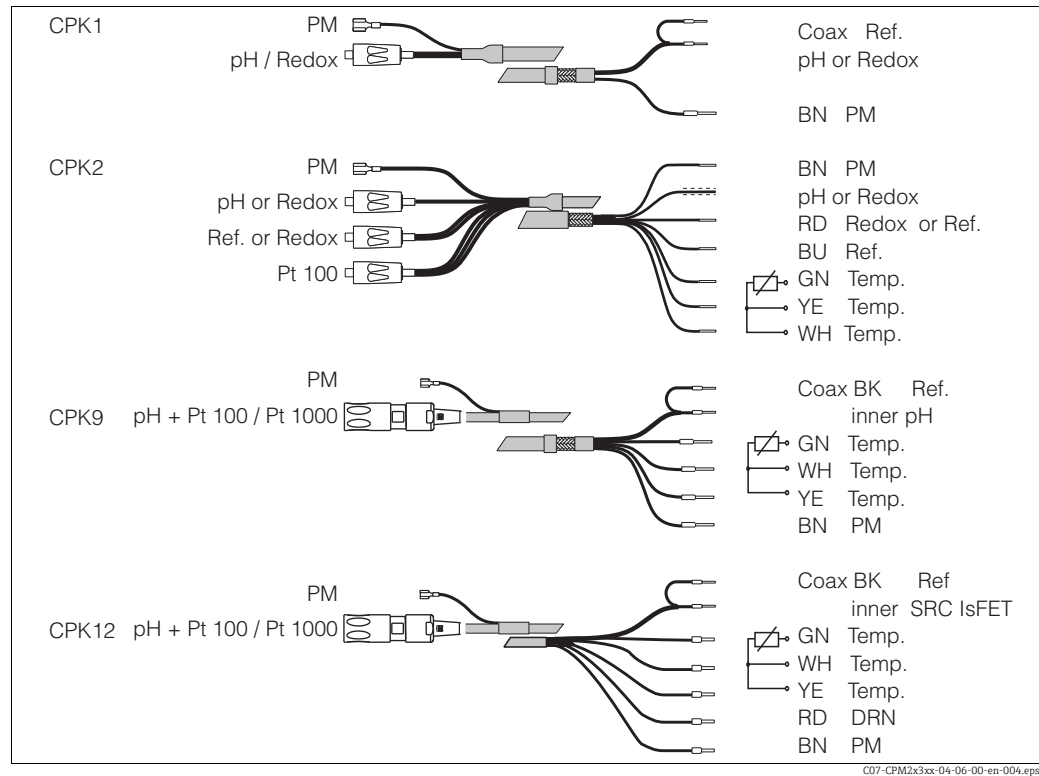

Fig. 12: Structure of the special measuring cables

i For further information on the cables and junction boxes, please refer to the "Accessories" section.

Field instrument measuring cable connection

Proceed as follows to connect a pH-electrode to the field instrument:

1. Open the housing cover to access the terminal block in the connection compartment.
2. Break the punching of a cable gland from the housing, mount a PG gland and guide the cable through this Pg gland.
3. Connect the cable in accordance with the terminal assignment .
4. Tighten the Pg gland.

NOTICE

Moisture could cause incorrect measurement

- Protect the connectors, cable ends and terminals against moisture.

Panel-mounted instrument measuring cable connection

To connect a pH electrode to the panel-mounted instrument, connect the cable in accordance with the terminal assignment to the terminals on the rear of the device.

If you are using glass electrodes with the panel-mounted instrument, you have to terminate the measuring cable with a BNC connector. A solder-free BNC connector is supplied with the device.

Proceed as follows:

1. Cut off end sleeves 2 and 3 of the coaxial cable (→  13).

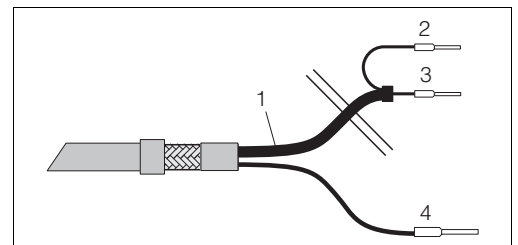

C07-CPM223xx-04-06-00-xx-013.eps

Fig. 13: Cable CPK1: device connection

- | | |
|---|------------------------|
| 1 | Coaxial cable |
| 2 | Inner screen BK (ref.) |
| 3 | Inner coax (pH / mV) |
| 4 | Strand BN (PM) |

2. Push the cable gland 5 and the washer 6 onto the coaxial cable.
3. Remove the insulation (13 mm (0.51")) and screw the clamping ring 7 onto the insulation.

-  Parts 5 to 7 are supplied with the BNC connector for cable diameters 3.2 mm (0.13") and 5 mm (0.20").

4. Fold the braided screen 8 of the screen over the clamping ring and cut off the excess material.

5. There is a semi-conductor layer 14 (conductive foil) between the inner insulation and the braided screen 8. Strip this semi-conductor layer to the braided screen.

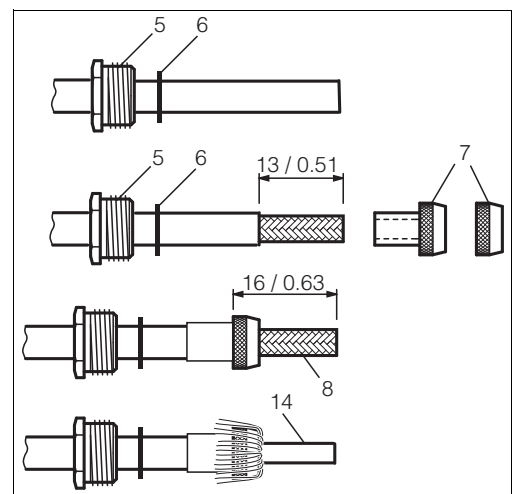

C07-CPM223xx-04-06-00-en-014.eps

Fig. 14: Terminating the pH connecting cable for mounting the BNC elbow plug

6. Remove the inner insulation (4 mm (0.16")).
7. Position end sleeve 13 onto the stripped inner conductor and secure the end sleeve with a crimping pliers.

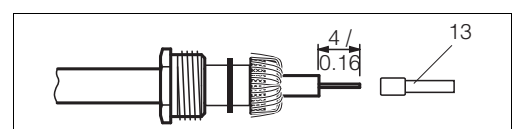

C07-CPM223xx-04-06-00-en-015.eps

Fig. 15: Terminating the pH connecting cable for mounting the BNC elbow plug

8. Push the BNC connector housing 9 over the cable. The inner conductor must be located at clamping surface 10 of the connector.
9. Tighten the cable gland 5.
10. Insert the clamp element 11 and screw in the connector cover 12. This creates a safe connection between the inner conductor and the connector pin.

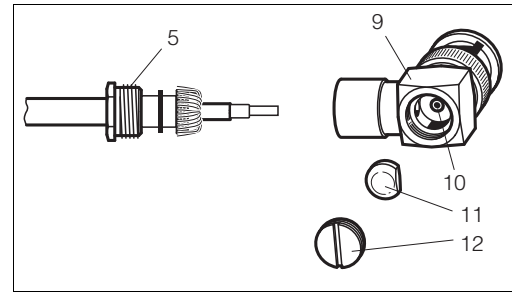

C07-CPM223xx-04-06-00-xx-016.eps

Fig. 16: Mounting the pH connecting cable in the BNC elbow plug

Examples for connecting pH and ORP sensors

The following diagrams show the connection of various pH and ORP sensors.

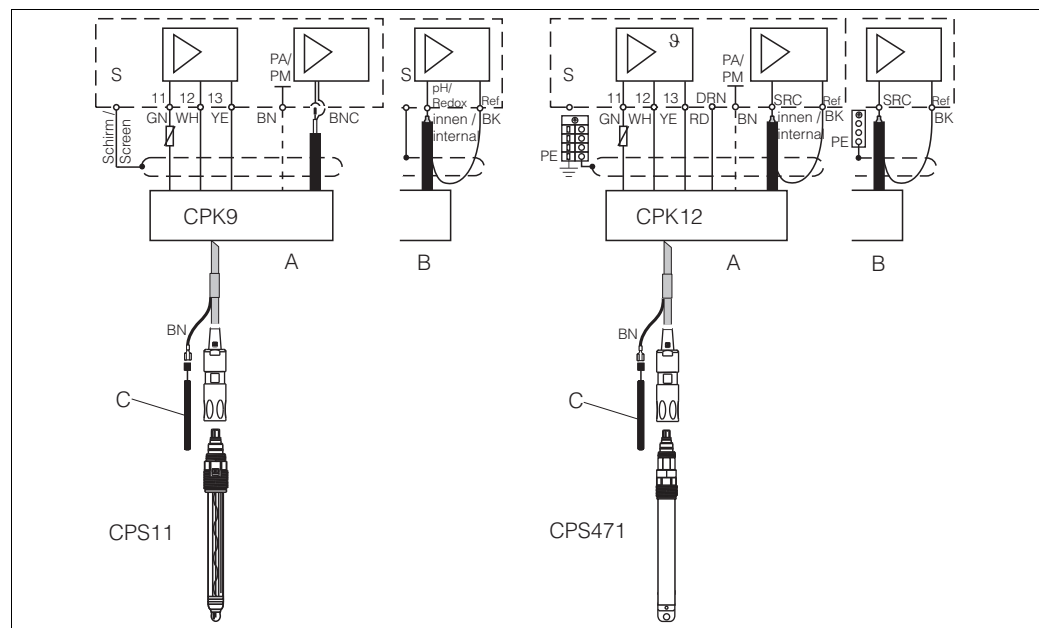

C07-CPM2x3xx-04-06-00-xx-010.eps

Fig. 17: Connecting glass electrode CPS11 with CPK9 (left) and ISFET sensor CPS471 with CPK12 (right) to Liquisys M

- A Panel-mounted instrument
- B Field instrument
- C Potential matching PM for symmetrical connection

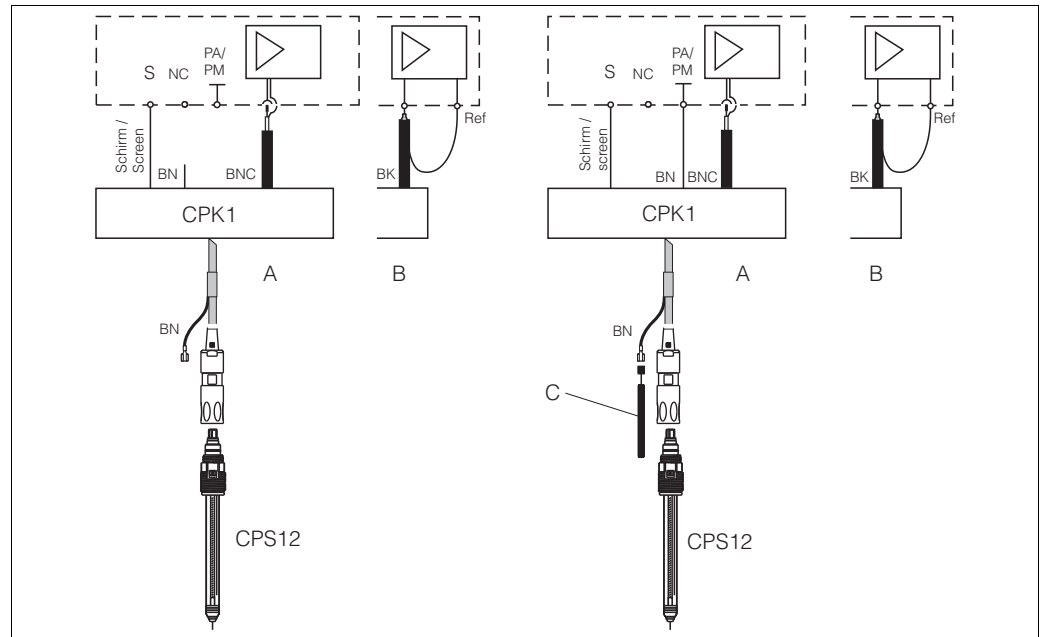

Fig. 18: Asymmetrical (without PML) and symmetrical (with PML) connection of ORP electrodes

- A Panel-mounted instrument
 B Field instrument
 C Potential matching (PM) in the medium for symmetrical connection

The pH and ORP sensors can be connected both symmetrically and asymmetrically. Generally, the following applies:

- No potential matching connection present: asymmetrical connection
- Potential matching connection present: symmetrical connection

The decision can also depend on the operating conditions.

Pay attention to the following:

- Liquisys M is pre-programmed for symmetrical measurement with potential matching. If you want asymmetrical measurement, you have to change the configuration in the A2 field.
- If the "asymmetrical" software setting was selected for a symmetrical connection, the operating time of the reference electrode is reduced.

i In the case of a symmetrical connection, the potential matching pin must be connected and always immersed in the medium.

Advantages of symmetrical vs. asymmetrical:

- Symmetrical measurement:
 - No leak current since the reference and the pH/ORP electrode is connected with high resistance
 - Safe measurement under difficult process conditions (strong flowing and high-resistance media, partially soiled diaphragm)
- Asymmetrical measurement:
 - Use of assemblies without potential matching possible

4.3 Electrical connection with Memosens functionality

4.3.1 Connection diagram

The wiring diagram depicted in →  19 shows the connections of an instrument equipped with all the options. Connecting the sensors is explained in more detail in the "Measuring cables and sensor connection" section.

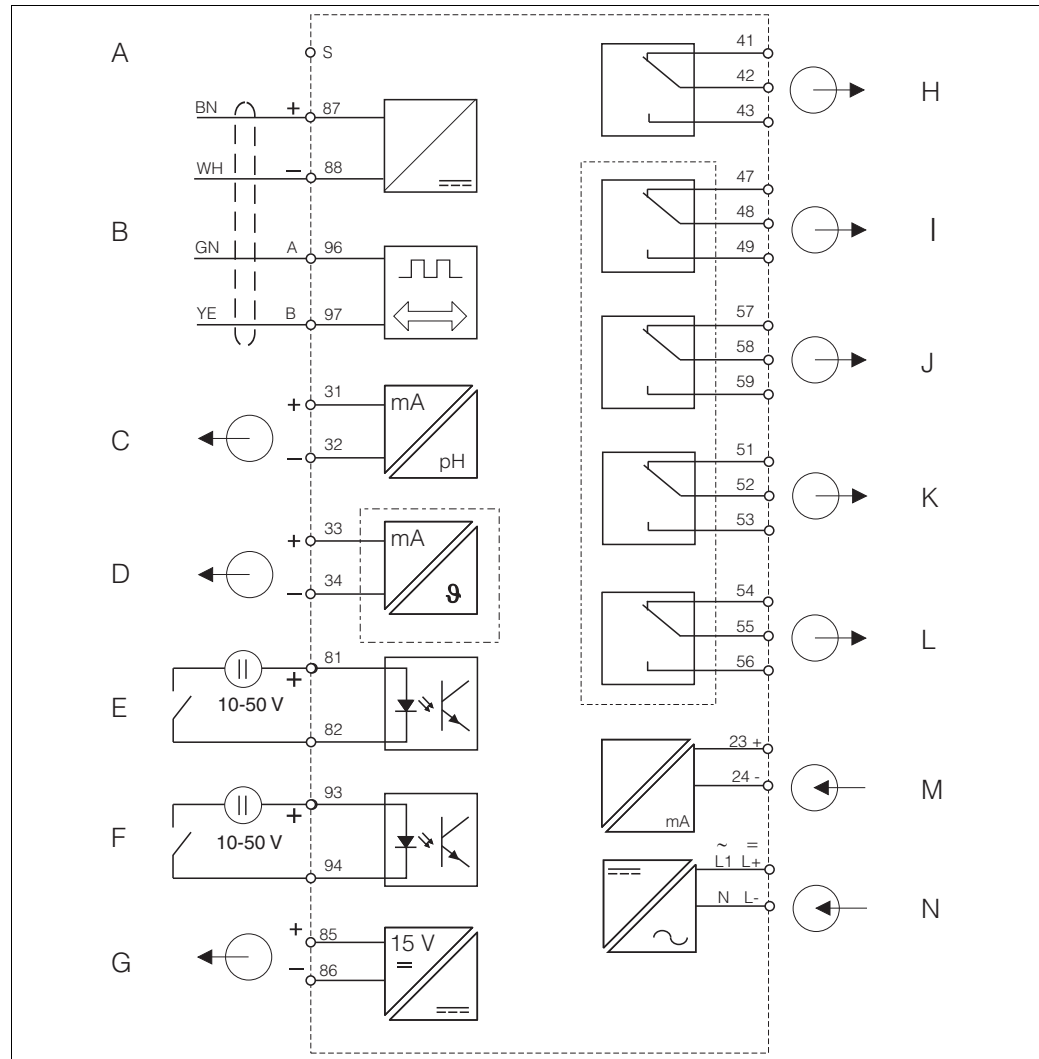

C07-CPM2x3xx-04-06-00-xx-002.esp

Fig. 19: Transmitter electrical connection with Memosens technology

A	Screen	H	Alarm (contact position currentless)
B	Sensor	I	Relay 1 (contact position currentless)
C	Signal output 1 pH/ORP	J	Relay 2 (contact position currentless)
D	Signal output 2 temperature, pH/ORP or controller	K	Relay 3 (contact position currentless)
E	Binary input 1 (Hold)	L	Relay 4 (contact position currentless)
F	Binary input 2 (Chemoclean)	M	Current input 4 ... 20 mA
G	Auxiliary voltage output	N	Power supply

 The device is approved for protection class II and is generally operated without a protective earth connection.
Do not connect the sensor screen at the transmitter.

Field instrument connection with Memosens functionality

Guide the measuring cables through the PG glands into the housing. Connect the measuring cables in accordance with the terminal assignment (→ 20).

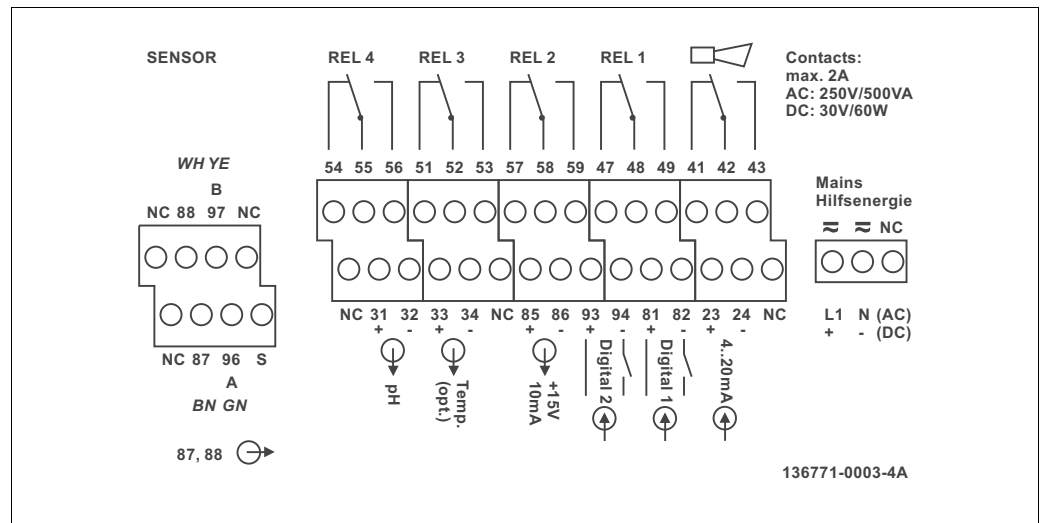

Fig. 20: Field instrument connection compartment sticker with Memosens functionality

NOTICE

Nonobservance could cause incorrect measurement

- ▶ Terminals marked NC may not be switched.
- ▶ Unmarked terminals may not be switched.

Panel-mounted instrument connection with Memosens functionality

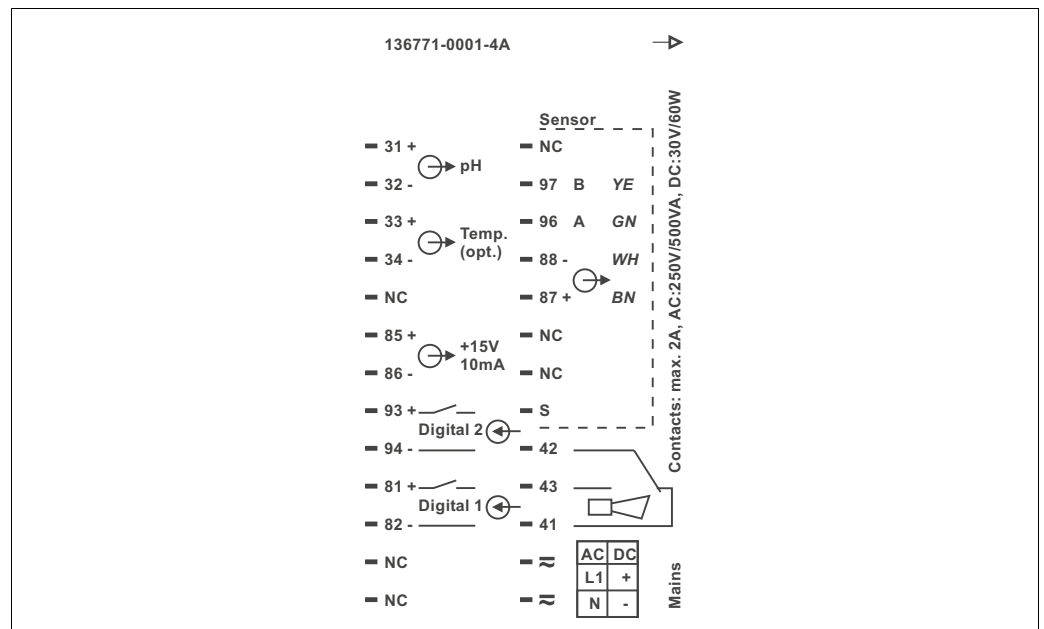

Fig. 21: Panel-mounted instrument connection sticker with Memosens functionality

NOTICE

Nonobservance could cause incorrect measurement

- ▶ Terminals marked NC may not be switched.
- ▶ Unmarked terminals may not be switched.

Please label the sensor terminal block with the TU-sticker provided. Do not use the pH-sticker.

4.3.2 Measuring cable and sensor connection

To connect pH electrodes with MemoSens functionality to the transmitter, you require the terminated data transmission cable CYK10 with 2x2 cores, twisted pair, screen and PVC jacket.

Structure of the measuring cable

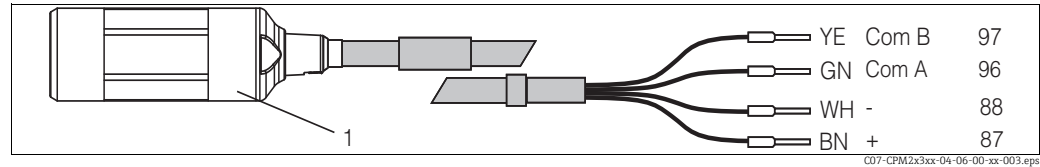

Fig. 22: Structure of the CYK10 measuring cable

1 Coupling (to connect to the sensor) with integrated electronics

i For further information on the cable, please refer to the "Accessories" section.

To plug the cable coupling onto the sensor plug-in head, proceed as follows:

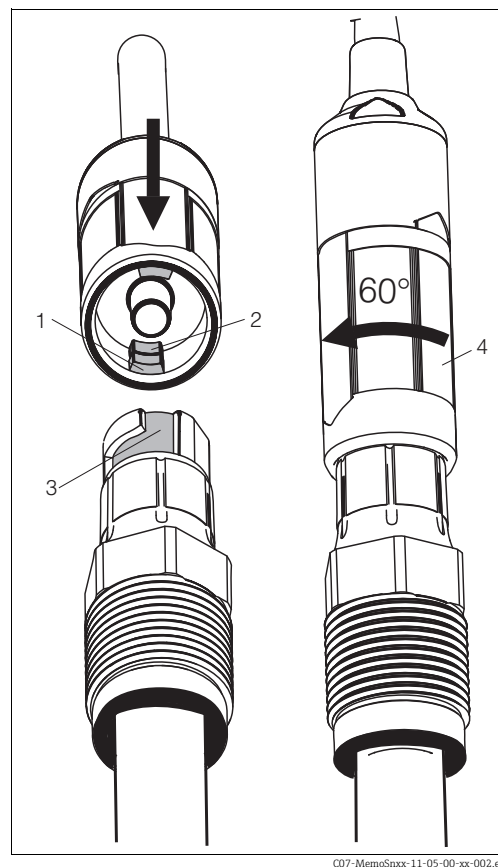

Fig. 23: Handling of sensor plug-in head and cable coupling

1. Rotate the lower part of the coupling in such a way that the two pairs of keys (pos. 1, 2) are located above each other.
2. Plug the coupling onto the plug-in head so that the keys engage in the slots of the plug-in head (pos. 3).
3. Turn the lower part of the coupling (pos. 4) clockwise as far as possible (approx. 60°). Doing so locks the coupling and prevents the connection from opening inadvertently.

Open the connection in the reverse sequence of operations.

Field instrument measuring cable connection

Proceed as follows to connect a pH-electrode with Memosens functionality to the field instrument:

1. Open the housing cover to access the terminal block in the connection compartment.
2. Break the punching of a cable gland from the housing, mount a PG gland and guide the cable through this Pg gland.
3. Connect the cable in accordance with the terminal assignment (see connection compartment sticker).
4. Tighten the Pg gland.

Panel-mounted instrument measuring cable connection

To connect a pH electrode with Memosens functionality, connect the CYK10 cable in accordance with the terminal assignment to the terminals on the rear of the device (see connection sticker).

Example of connecting pH electrode

The following diagram shows the connection of a pH-electrode with Memosens functionality.

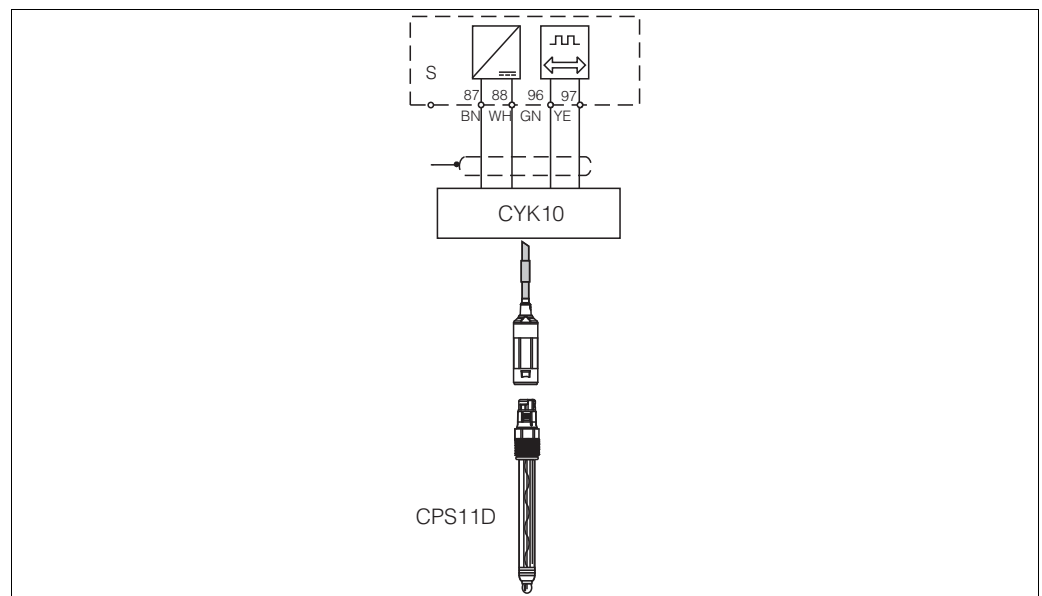

Fig. 24: Connecting CPS11D with CYK10

C07-CPM2x3xx-04-06-00-xx-012.eps

Signal transmission between the Memosens electrode and the coupling of the CYK10 cable takes place contact free and via completely encapsulated coils. This offers the following advantages:

- Thanks to the fact that the electrode and transmitter are galvanically isolated, the signals are not affected by secondary potential. As a result, in contrast to sensors without Memosens functionality, no symmetrically high-resistance connection is required to guarantee safe measurement.
- The Memosens plug-in head and the Memosens coupling are completely water-proof.
- There are no open contacts. Contact corrosion, creepage currents and shunts are ruled out.

4.4 Alarm contact

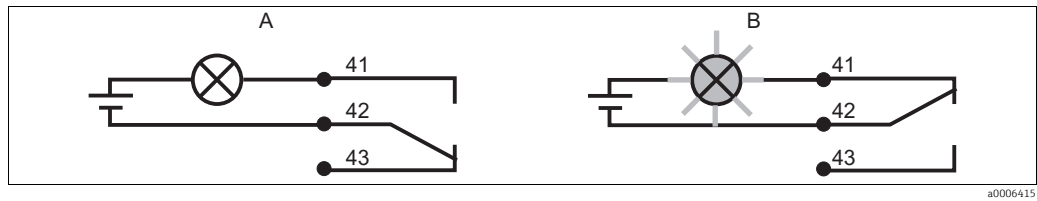

Fig. 25: Recommended fail-safe switching for the alarm contact
 A Normal operating status

B Alarm condition

Normal operating status:

Device in operation and no error message present (alarm LED off)

- Relay energized
- Contact 42/43 closed

Alarm condition

Error message present (alarm LED red) or device defective or voltage-free (alarm LED off)

- Relay de-energized
- Contact 41/42 closed

4.5 Post-connection check

After wiring up the electrical connection, carry out the following checks:

Device status and specifications	Remarks
Are the transmitter or the cable externally damaged?	Visual inspection

Electrical connection	Remarks
Are the installed cables strain-relieved?	
No loops and cross-overs in the cable run?	
Are the signal cables correctly connected acc. to the wiring diagram?	
Are all screw terminals tightened?	
Are all cable entries installed, tightened and sealed?	
Are the PE distributor rails grounded (if present)?	Grounding at place of installation

5 Operability

5.1 Quick operation guide

You have the following ways of operating the transmitter:

- On site via the key field
- Via the HART interface (optional, with corresponding order version) per:
 - HART handheld terminal or
 - PC with HART modem and the FieldCare software package
- Via PROFIBUS PA/DP (optional, with corresponding order version) with:
 - PC with corresponding interface and the FieldCare software package (see Accessories) or
 - via a programmable logic controller (PLC)

 For operation via HART or PROFIBUS PA/DP, please read the relevant sections in the additional Operating Instructions:



- PROFIBUS PA/DP, field communication for Liquisys M CXM223/253, BA00209C/07/EN
- HART, field communication for Liquisys M CXM223/253, BA00208C/07/EN

The following section only explains operation via the keys.

5.2 Display and operating elements

5.2.1 Display

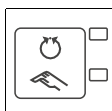
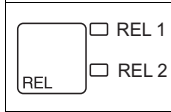
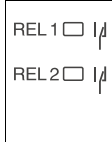
LED display

	Indicates the current operating mode, "Auto" (green LED) or "Manual" (yellow LED)
	Indicates the activated relay in the "Manual" mode (red LED)
	Indicates the working status of relay 1 and 2 LED green: measured value within the permitted limit, relay inactive LED red: measured value outside the permitted limit, relay active
	Alarm display, e.g. for continuous limit value overshoot. Temperature sensor failure or system error (see error list)

LC display

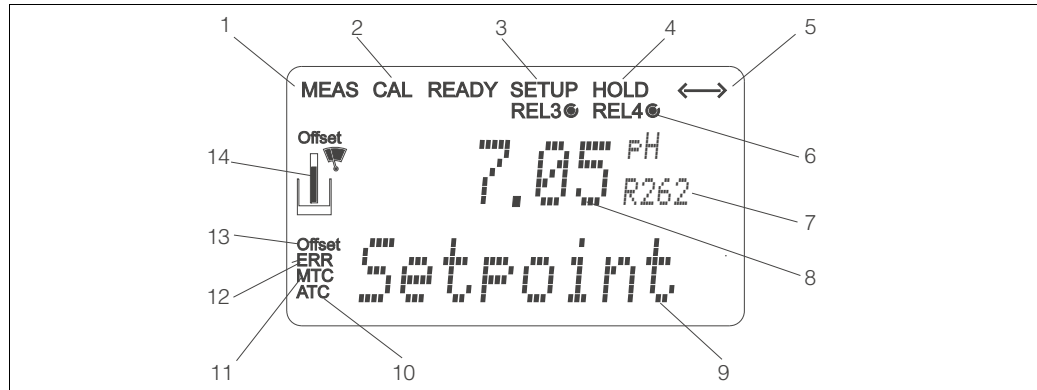

C07-C2M2x3xx-07-06-00-en-004.eps

Fig. 26: Transmitter LC display

- | | | | |
|---|--|----|--|
| 1 | Indicator for measuring mode (normal operation) | 8 | In measuring mode: measured variable
In setup mode: configured variable |
| 2 | Indicator for calibration mode | 9 | In measuring mode: secondary measured value
In setup/calibr. mode: e.g. setting value |
| 3 | Indicator for setup mode (configuration) | 10 | Indicator for autom. temperature compensation |
| 4 | Indicator for "Hold" mode (current outputs remain at last current state) | 11 | Indicator for man. temperature compensation |
| 5 | Indicator for receipt of a message for devices with communication | 12 | "Error": error display |
| 6 | Indicator of working status of relays 3/4:
○ inactive, ● active | 13 | Temperature offset |
| 7 | Function code display | 14 | Sensor symbol |

5.2.2 Operating elements

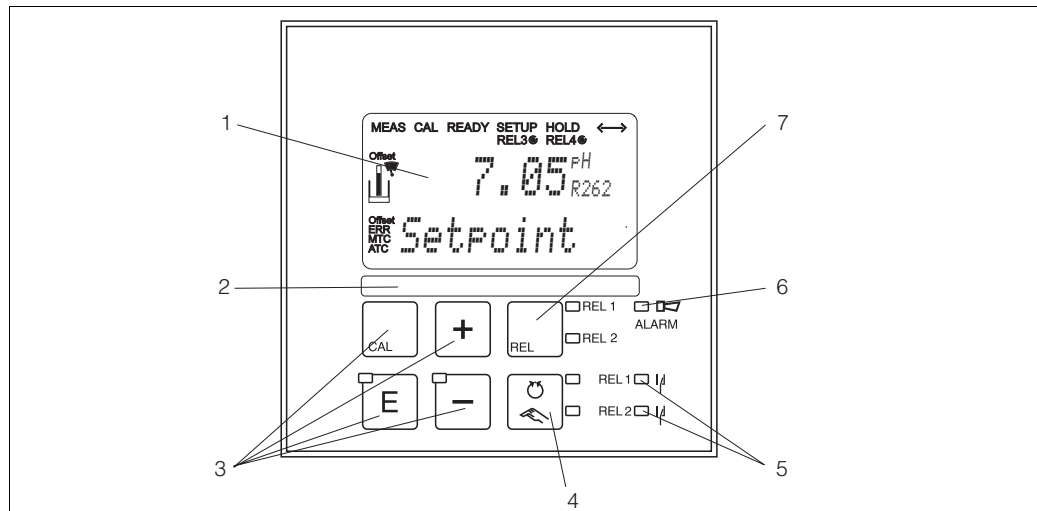









C07-CPM2x3xx-19-06-00-en-001.eps

Fig. 27: Operating elements

- | | |
|---|---|
| 1 | LC display for displaying the measuring values and configuration data |
| 2 | Field for user labelling |
| 3 | 4 main operating keys for calibration and device configuration |
| 4 | Changeover switch for automatic/manual mode |
| 5 | LEDs for limit contactor relay (switch status) |
| 6 | LED for alarm function |
| 7 | Display of the active contact and key for relay changeover in manual mode |

5.2.3 Key assignment

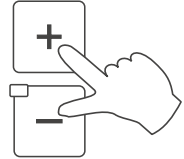
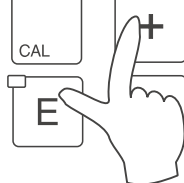
	<p>CAL key When you press the CAL key, the device first prompts you for the calibration access code:</p> <ul style="list-style-type: none"> ▪ Code 22 for calibration ▪ Code 0 or any other code for reading the last calibration data <p>Use the CAL key to accept the calibration data or to switch from field to field within the calibration menu.</p>
	<p>ENTER key When you press the ENTER key, the device first prompts you for the setup mode access code:</p> <ul style="list-style-type: none"> ▪ Code 22 for setup and configuration ▪ Code 0 or any other code for reading all the configuration data. <p>The ENTER key has several functions:</p> <ul style="list-style-type: none"> ▪ Calls up the Setup menu from the measuring mode ▪ Saves (confirms) data entered in the setup mode ▪ Moves on within function groups.
 	<p>PLUS key and MINUS key In the setup mode, the PLUS and MINUS keys have the following functions:</p> <ul style="list-style-type: none"> ▪ Selection of function groups. <ul style="list-style-type: none">  Press the MINUS key to select the function groups in the order given in the "System configuration" section. ▪ Configuration of parameters and numerical values ▪ Operation of the relay in manual mode <p>In the measuring mode, you get the following sequence of functions by repeatedly pressing the PLUS key:</p> <ol style="list-style-type: none"> 1. Temperature display in F 2. Temperature display hidden 3. Measured value display in mV 4. Current input signal in % 5. Current input signal in mA 6. Return to basic settings <p>In the measuring mode, the following is displayed in sequence by repeatedly pressing the MINUS key:</p> <ol style="list-style-type: none"> 1. Current errors are displayed in rotation (max. 10). 2. Once all the errors have been displayed, the standard measurement display appears. In the function group F, an alarm can be defined separately for each error code.
 <ul style="list-style-type: none"> <input type="checkbox"/> REL 1 <input type="checkbox"/> REL 2 	<p>REL key In the manual mode, you can use the REL key to switch between the relay and the manual start of cleaning. In the automatic mode, you can use the REL key to read out the switch-on points (for limit contactor) or set points (for PID controller) assigned to the relay in question. Press the PLUS key to jump to the settings of the next relay. Use the REL key to get back to the display mode (automatic return after 30 s).</p>





	<p>AUTO key You can use the AUTO key to switch between automatic mode and manual mode.</p>
	<p>Escape function If you press the PLUS and MINUS key simultaneously, you return to the main menu or are taken to the end of calibration if calibrating. If you press the PLUS and MINUS key again, you return to the measuring mode.</p>
	<p>Locking the keyboard Press the PLUS and ENTER key for at least 3 s to lock the keyboard against any unauthorized data entry. All the settings can continue to be read. The code prompt displays the code 9999.</p>
	<p>Unlocking the keyboard Press the CAL and MINUS key for at least 3 s to unlock the keyboard. The code prompt displays the code 0.</p>

5.3 Local Operation

5.3.1 Automatic/manual mode

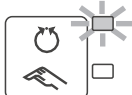
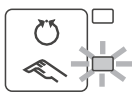
The transmitter normally operates in automatic mode. Here, the relays are triggered by the transmitter. In the manual mode, you can trigger the relays using the REL key or start the cleaning function.

How to change the operating mode:

	<p>1. The transmitter is in Automatic mode. The top LED beside the AUTO key is lit.</p>
	<p>2. Press the AUTO key.</p>
	<p>3. To enable the manual mode, enter the code 22 via the PLUS and MINUS keys. The bottom LED beside the AUTO key lights up.</p>
	<p>4. Select the relay or the function. You can use the REL key to switch between the relays. The relay selected and the switch status (ON/OFF) is displayed on the second line of the display. In the manual mode, the measured value is displayed continuously (e.g. for measured value monitoring for dosing functions).</p>
	<p>5. Switch the relay. It is switched on with PLUS and switched off with MINUS. The relay remains in its switched state until it is switched over again.</p>
	<p>6. Press the AUTO key to return to the measuring mode, i.e. to the automatic mode. All the relays are triggered again by the transmitter.</p>

Pay attention to the following:

- The selected operating mode remains in effect even after a power failure.
- The manual mode has priority over all automatic functions (Hold).
- Hardware locking is not possible in the manual mode.
- The manual settings are kept until they are actively reset.
- Error code E102 is signalled in the manual mode.

5.3.2 Operating concept

Operating modes

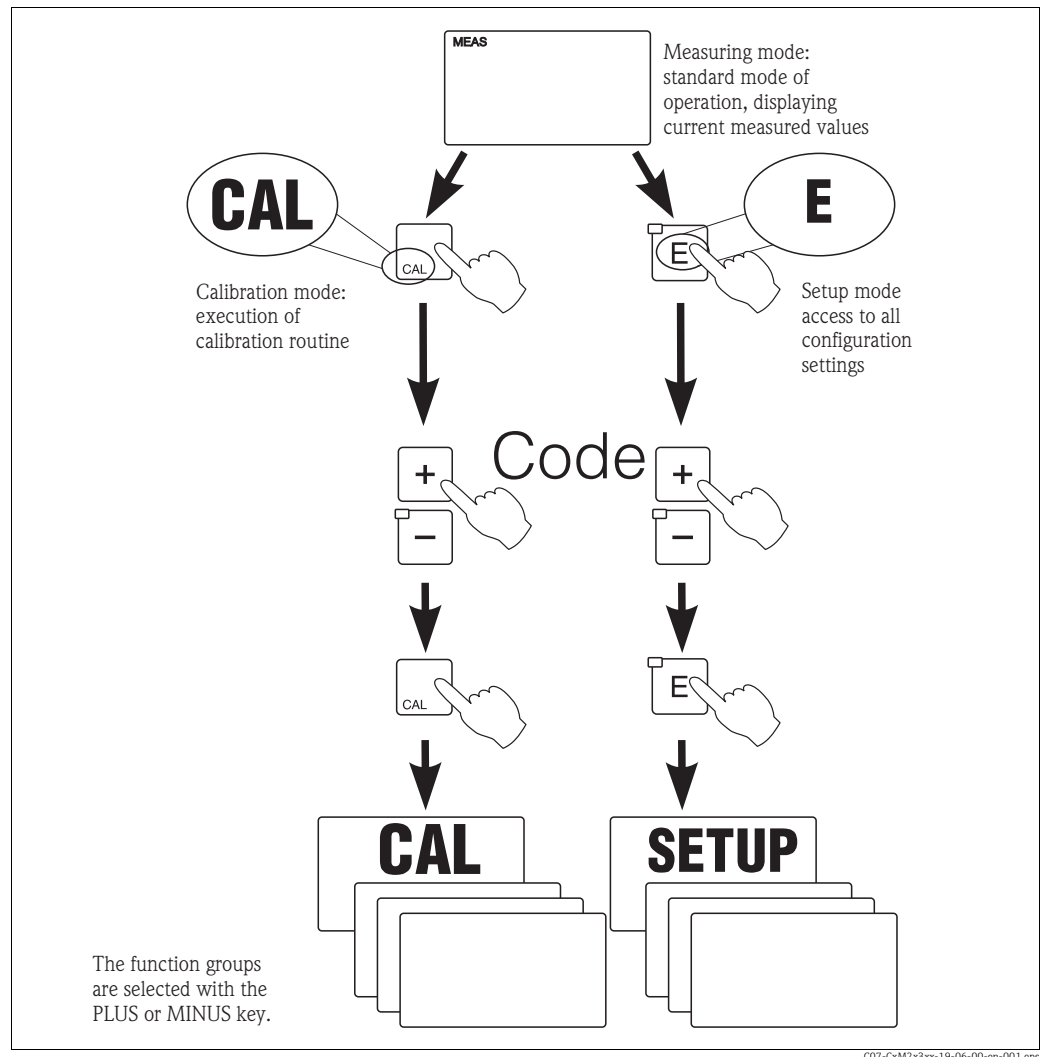

Fig. 28: Description of the possible operating modes

- i** If no key is pressed in the setup mode for approx. 15 min, the device automatically returns to the measuring mode. Any active Hold (Hold during setup) is reset.

Access codes

All device access codes are fixed and cannot be altered. When the device requests the access code, it distinguishes between different codes.

- **Key CAL + Code 22:** access to Calibration and Offset menu
- **Key ENTER + Code 22:** access to the setup menus
- **Keys PLUS + ENTER:** locks the keyboard
- **Keys CAL + MINUS:** unlocks the keyboard
- **Key CAL or ENTER + any code:** access to read mode, i.e. all the settings can be read but not modified.

The device continues measuring in the read mode. It does not shift to the Hold status. The current output and the controllers remain active.

Menu structure

The configuration and calibration functions are arranged in function groups.

- In setup mode, select a function group with the PLUS and MINUS keys.
 - In the function group itself, switch from function to function with the ENTER key.
 - Within the function, select the desired option with the PLUS and MINUS keys or edit the settings with these keys. Then confirm with the ENTER key and continue.
 - Press the PLUS and MINUS keys simultaneously (Escape function) to exit programming (return to the main menu).
 - Press the PLUS and MINUS simultaneously keys again to switch to the measuring mode.
- i** If a modified setting is not confirmed with ENTER, the old setting is retained.
An overview of the menu structure is provided in the Appendix to these Operating Instructions.

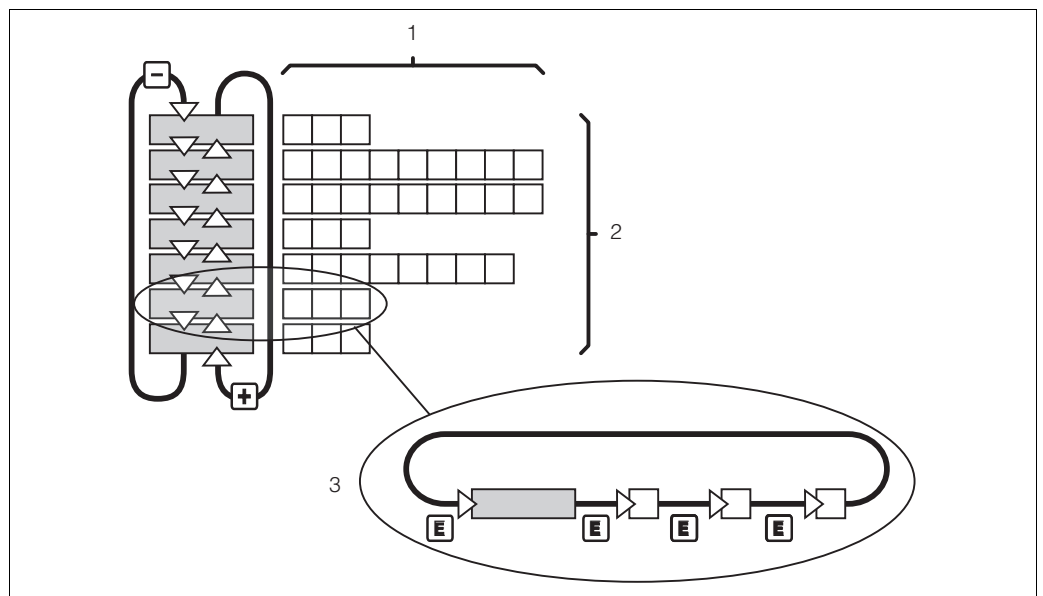

Fig. 29: Diagram of the menu structure

- 1 Functions (parameters selected, numbers entered)
- 2 Function groups, scroll backwards and forwards with the PLUS and MINUS keys
- 3 Switch from function to function with the ENTER key

Hold function: "freezing" of the outputs

During setup and calibration, the current output can be "frozen". It constantly retains its current status. "HOLD" appears on the display. If the controller actuating variable (steady control 4 to 20 mA) is output via current output 2, it is set to 0/4 mA in Hold.

Pay attention to the following:

- Hold settings can be found in the "Service" section.
- During Hold, all contacts will go to their normal positions.
- An active Hold has priority over all other functions.
- With every Hold, the I-component of the controller is set to zero.
- Any alarm delay is reset to "0".
- This function can also be activated externally via the Hold input (see Wiring diagram; binary input 1).
- The manual Hold (field S3) remains active even after a power failure.

6 Commissioning

6.1 Things to note when commissioning digital sensors

pH sensors with Memosens functionality save the calibration data. For this reason, commissioning these sensors is different to commissioning standard electrodes.

Proceed as follows:

1. Install the transmitter and the assembly.
2. Connect the transmitter and the sensor cable.
3. Configure the transmitter for your specific requirements (see "System configuration" section).
4. Connect the sensor with the Memosens functionality, which was precalibrated at the factory, and immerse it into the medium or the buffer.
5. The saved sensor-specific calibration data are automatically transmitted to the transmitter.
6. The measured value is displayed.
Normally, you can accept this value without calibrating the sensor. A calibration is only necessary in the following instances:
 - Where there are strict requirements in terms of accuracy
 - When the sensor has been in storage for more than 3 months
7. Check the measured value transfer to the process control system or the signal processing unit.

6.2 Things to note when commissioning ISFET sensors

Switch-on behaviour

A control circuit is created when the measuring system is switched on. During this time (approx. 5 to 8 minutes), the measured value adjusts to the real value. This settling behaviour occurs every time the liquid film between the pH-sensitive semi-conductor and the reference lead is interrupted (e.g. caused by dry storage or intensive cleaning with compressed air). The settling time depends on the length of the interruption.

Sensitivity to light

Like all semi-conductor elements, the ISFET chip is sensitive to light (measured value fluctuations). However, this only affects the measured value if the sensor is directly exposed to sunlight. For this reason, avoid direct sunlight when calibrating. Normal ambient light does not have any effect on the measurement.

6.3 Function check

▲ WARNING

Incorrect connection, incorrect supply voltage

Safety risks for staff and incorrect operation of the device

- ▶ Check that all connections have been established correctly in accordance with the wiring diagram.
- ▶ Make sure that the supply voltage matches the voltage indicated on the nameplate.

6.4 Switching on

Familiarize yourself with the operation of the transmitter before it is first switched on. Please refer in particular to the "Safety instructions" and "Operation" sections. After power-up, the device performs a self-test and then goes to the measuring mode. Now calibrate the sensor in accordance with the instructions in the "Calibration" section.

i During commissioning, the sensors (except digital sensors) must be calibrated so that the measuring system can return precise measurement data.

Then perform the first configuration in accordance with the instructions in the "Quick start-up" section. The values set by the user are kept even in the event of a power failure. The following function groups are available in the transmitter (the groups only available in the Plus Package are marked accordingly in the functional description):

Setup mode

- SETUP 1 (A)
- SETUP 2 (B)
- CURRENT INPUT (Z)
- CURRENT OUTPUT (O)
- ALARM (F)
- CHECK (P)
- RELAY (R)
- SERVICE (S)
- E+H SERVICE (E)
- INTERFACE (I)

Calibration and offset mode

- CALIBRATION (C)
- NUMERIC (N)
- OFFSET (V)

i A detailed explanation of the function groups available in the transmitter can be found in the "System configuration" section.

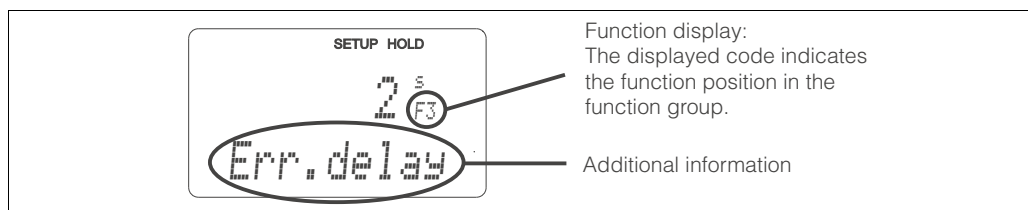

Fig. 30: Example for display in setup mode

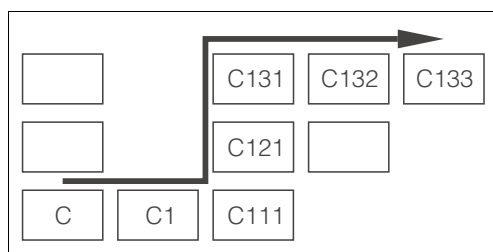

Fig. 31: Function coding

Selecting and locating functions is facilitated by a code displayed for each function in a special display field → 30.

The structure of this coding is given in → 31.

The first column indicates the function group as a letter (see group designations). The functions in the individual groups are counted from the top to the bottom and from the left to the right.

Factory settings

The first time it is switched on, the device has the factory setting for all functions. The table below provides an overview of the most important settings.

All other factory settings can be found in the description of the individual function groups in the "System configuration" section (the factory setting is highlighted in **bold**).

Function	Factory setting
Type of measurement	pH or ORP absolute, Temperature measurement in C
Type of measurement compensation	Linear with reference temperature 25 °C (77 °F)
Temperature compensation	Automatic (ATC on)
Limit value for controller 1	pH 16 (ORP: -1500 mV or 0 %)
Limit value for controller 2	pH 16 (ORP: +1500 mV or 100 %)
Hold	Active during configuration and calibration
Contact 1 to 4	Limit contactor pH, function off
Current outputs 1* and 2*	4 to 20 mA
Current output 1: measured value for 4 mA signal current*	pH 2
Current output 1: measured value for 20 mA signal current*	pH 12
Current output 2: temperature value for 4 mA signal current*	0.0 °C (32 °F)
Current output 2: temperature value for 20 mA signal current*	100.0 °C (212 °F)

* For corresponding version

6.5 Quick start-up

After power-up, you must make some settings to configure the most important functions of the transmitter which are required for correct measurement. The following section gives an example of this.

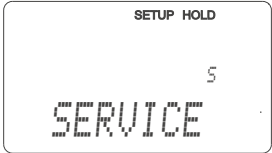
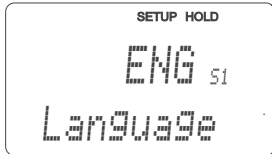
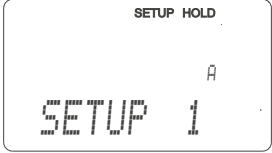
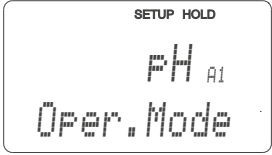
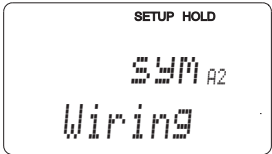
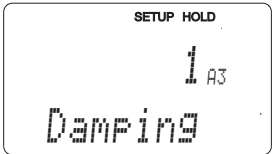
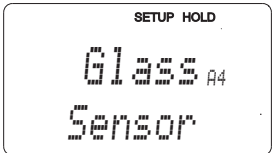
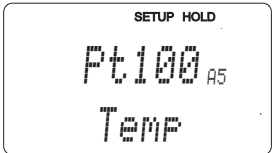
User input	Setting range (Factory settings, bold)	Display
1. Press the [E] key. 2. Enter the code 22 to edit the setup. Press [E] .		
3. Press [−] until you get to the "Service" function group. 4. Press [E] to be able to make your settings.		 <p>SETUP HOLD 5 SERVICE</p>
5. In S1, select your language, e.g. "ENG" for English. Press [E] to confirm.	ENG = English GER = German FRA = French ITA = Italian NEL = Dutch ESP = Spanish	 <p>SETUP HOLD ENG S1 Language</p>
6. Press [+] simultaneously to exit the "Service" function group.		
7. Press [−] until you get to the "Setup 1" function group. 8. Press [E] to be able to make your settings for "Setup 1".		 <p>SETUP HOLD A SETUP 1</p>
9. In A1, select the desired mode of operation, e.g. "pH". Press [E] to confirm.	pH ORP (= redox) mV ORP (= redox) %	 <p>SETUP HOLD pH A1 Oper. Mode</p>
10. In A2, select the type of connection for your sensor. See the "Sensor connection" section for this. Press [E] to confirm.	sym = symmetrical asym = asymmetrical	 <p>SETUP HOLD sym A2 Wiring</p>
11. In A3, enter the damping factor. Measured value damping averages the individual measured values and serves to stabilise the display and the signal output. Enter "1" if no measured value damping is required. Press [E] to confirm.	1 1 to 60	 <p>SETUP HOLD 1 A3 Damping</p>
12. In A4, specify the type of sensor that you are using, e.g. "Glass" for glass electrode. Press [E] to confirm.	Glass ISFET	 <p>SETUP HOLD Glass A4 Sensor</p>
13. In A5, select the temperature sensor the electrode used has, e.g. "Pt 100" for a glass electrode. Press [E] to confirm your entries. The display returns to the initial display of the "Setup 1" function group.	Pt 100 Pt 1K NTC 30K None	 <p>SETUP HOLD Pt100 A5 Temp</p>

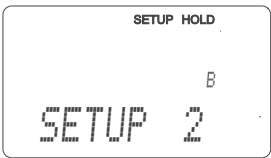
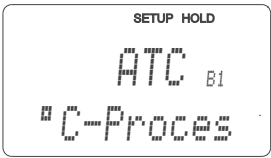
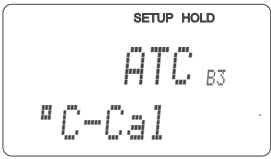
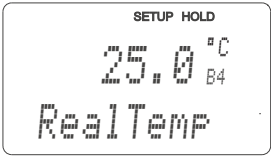
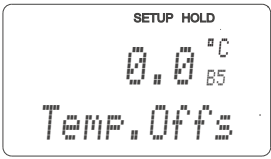
User input	Setting range (Factory settings, bold)	Display
<p>14. Press [] to get to the "Setup 2" function group.</p> <p>15. Press [E] to make your settings for "Setup 2".</p>		
<p>16. In B1, select the type of temperature compensation for the process, e.g. ATC for automatic temperature compensation. Press [E] to confirm. If you have chosen ATC, the menu jumps automatically to field B3.</p>	<p>ATC MTC</p>	
<p>17. In B3, select the type of temperature compensation for the calibration, e.g. ATC for automatic temperature compensation. Press [E] to confirm.</p>	<p>ATC MTC</p>	
<p>18. The current temperature is displayed in B4. If necessary, calibrate the temperature sensor to an external measurement. Press [E] to confirm.</p>	<p>Actual value displayed and entered -50.0 to 150.0 °C</p>	
<p>19. The difference between the measured and entered temperature is displayed. Press [E]. The display returns to the initial display of the "Setup 2" function group.</p>	<p>0.0 C -5.0 to 5.0 °C</p>	
<p>20. Press [+/-] simultaneously to switch to the measurement mode.</p>		





6.6 System configuration

6.6.1 Setup 1 (pH / ORP)

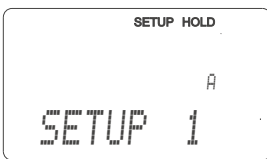
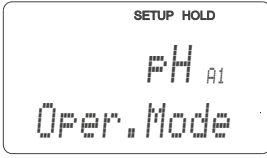

In the SETUP 1 function group, change the settings for the measuring mode and the sensor. All the settings in this menu are made during initial commissioning. However, you can change the settings at any time.

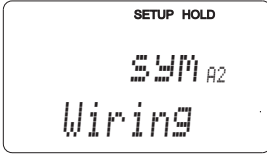
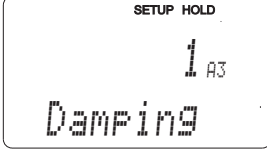
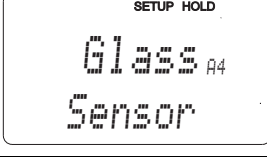
 An error message (E010) is output if the temperature sensor is defective. Measuring continues at a process temperature of 25°C (77 °F).

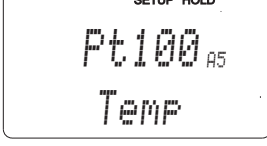
Setup 1 for ISFET and standard sensors

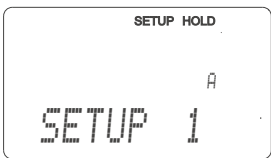
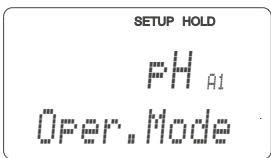
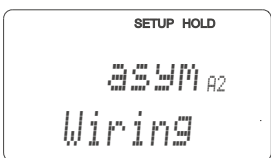
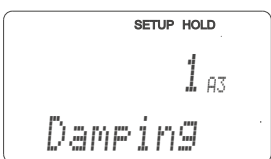
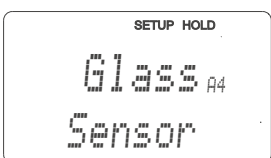

Coding	Field	Setting range (Factory settings, bold)	Display	Info
A	SETUP 1 function group			Configuration of basic functions
A1	Select operating mode	pH ORP (= redox) mV ORP (= redox) %		 When the operating mode is changed, all user settings are automatically reset to the factory settings.
A2	Select connection mode	Sym = symmetrical Asym = asymmetrical		Detailed information on symmetrical or asymmetrical connections can be found in the "Sensor connection" section.
A3	Enter measured value damping	1 1 to 60		Measured value damping causes averaging over the number of individual measured values entered. This is used, for example, to stabilise the display if the measurement is unstable. There is no damping if "1" is entered.
A4	Select sensor	Glass Antimony ISFET		For glass electrodes: glass For ISFET sensors: ISFET  Glass electrodes may only be used with zero point pH 7.
A5	Select temperature sensor	Pt 100 Pt 1K NTC 30 K None		Field only available for version "IS" For ISFET sensors: Pt 1K (Pt 1000) For glass electrodes: Pt 100 NTC 30k not used No temperature sensor: Select MTC in B1

Setup 1 for digital sensors

Coding	Field	Setting range (Factory settings, bold)	Display	Info
A	SETUP 1 function group			Configuration of basic functions
A1	Operating mode	pH		No edit option.
A2	Type of connection	asym = asymmetrical		No edit option. Thanks to the non-contact, galvanically isolated signal transmission, only simple asymmetrical connection necessary.
A3	Enter measured value damping	1 1 to 60		Measured value damping causes averaging over the number of individual measured values entered. This is used, for example, to stabilise the display if the measurement is unstable. There is no damping if "1" is entered.
A4	Sensor	Glass		No edit option.  Glass electrodes may only be used with zero point pH 7.

6.6.2 Setup 2 (temperature)

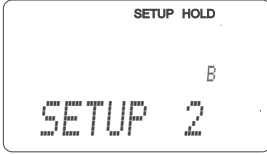
Use this function group to change the settings for temperature measurement. You already made all the settings of this function group during initial commissioning. However, you can change the values chosen at any time.

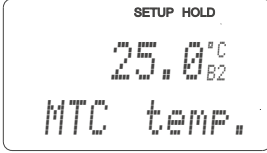
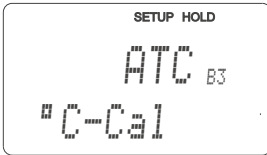
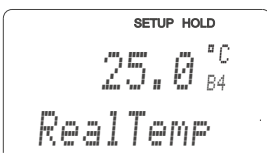
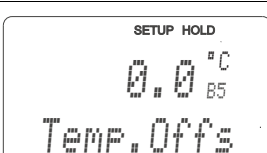
Coding	Field	Setting range (Factory settings, bold)	Display	Info
B	SETUP 2 function group			Settings for temperature measurement.
B1	pH Type of temperature compensation for the process ORP Temperature measurement	<ul style="list-style-type: none"> For pH operating mode: ATC MTC For ORP operating mode: Off On 		For B1 = ATC: jump to B3. For B1 = MTC: in B2, enter the process temperature which is to be used for compensation.
B2	Enter process temperature	25,0 °C -50.0 to 150.0 °C		Only if A1 = pH and B1 = MTC. You can edit the displayed value. The value entered can only be in °C.
B3	Select the type of temperature compensation for the calibration	ATC MTC		For B1 = ATC: edit possible. For B1 = MTC: only display B3 = MTC, return to B. A separate temperature sensor must also be immersed in the buffer solution.
B4	Enter temperature	25 °C -50.0 to 150.0 °C		Only for B1 = ATC. You can edit the displayed value. The value entered can only be in °C.
B5	Temperature difference (offset) is displayed	0,0 °C -5.0 to 5.0 °C		Only for B1 = ATC. The difference between the measured and entered temperature is displayed.

6.6.3 Current input

With the "Current input" function group, you can monitor process parameters and use these for feedforward control. For this purpose, you must connect the current output of an external measured variable (e.g. flowmeter) to the 4 to 20 mA input of the transmitter. The following assignment applies:

	Flow in main stream	Current signal in mA	Current input signal in %
Current input lower range limit	Flowmeter lower setting value	4	0
Current input upper range limit	Flowmeter upper setting value	20	100

Monitoring of flow in main stream

This arrangement is particularly practical if the sample flow through a flow assembly in an open outlet is completely independent of the flow in the main stream.

This permits signalling of an alarm condition in the main stream (flow too low or has completely stopped) and triggers dosing switch-off even if the medium flow is retained due to the method of installation.

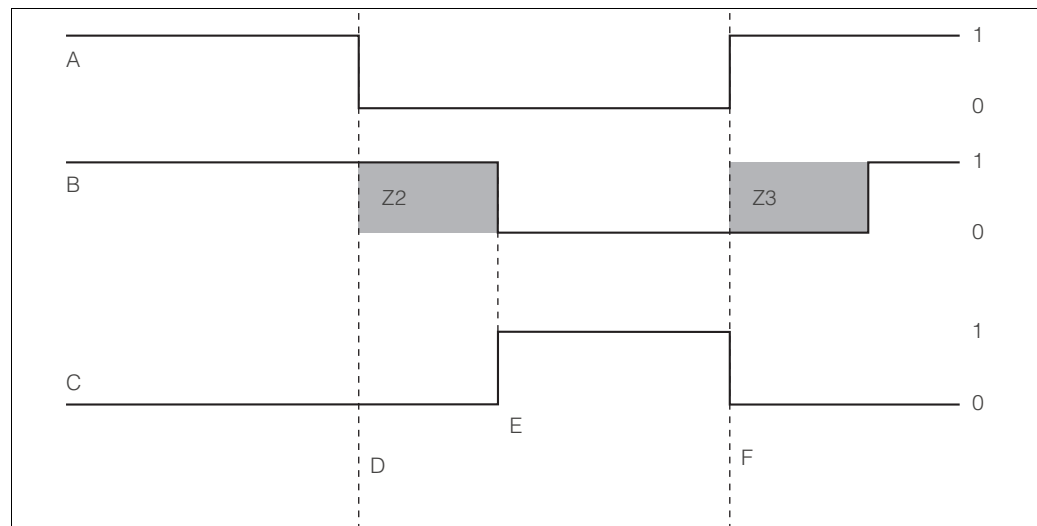

C07-CPM2x3xx-05-06-00-xx-001.eps

Fig. 32: Alarm signalling and dosing switch-off by the main stream

A	Flow in main stream	F	Flow restoration
B	Relay contacts of PID controller	Z2	Delay for controller switch-off, see field Z2
C	Alarm relay	Z3	Delay for controller switch-up, see field Z3
D	Flow below switch-off limit Z 4 or flow failure	0	Off
E	Flow alarm	1	On

Feedforward control to PID controller

For control systems with very short reaction times, it can be useful to also apply the flow rate, if it is fluctuating, to the controller to optimize the control process.

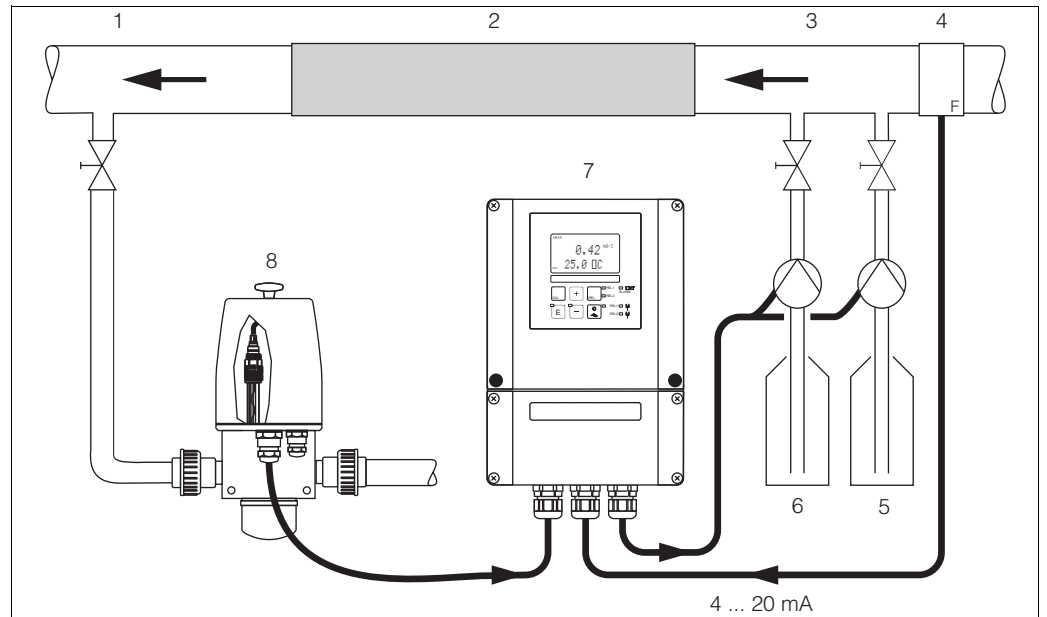

Fig. 33: Sample arrangement for feedforward control of the flow in the main stream to the PID controller

- | | |
|------------------------------------|---------------------|
| 1 Measuring water extraction point | 5 Alkali |
| 2 Static mixer | 6 Acid |
| 3 Injection points | 7 Liquisys M CPM253 |
| 4 Flowmeter | 8 CPA250 with CPS11 |

Feedforward control is a multiplying function as illustrated in the figure below (example with factory setting):

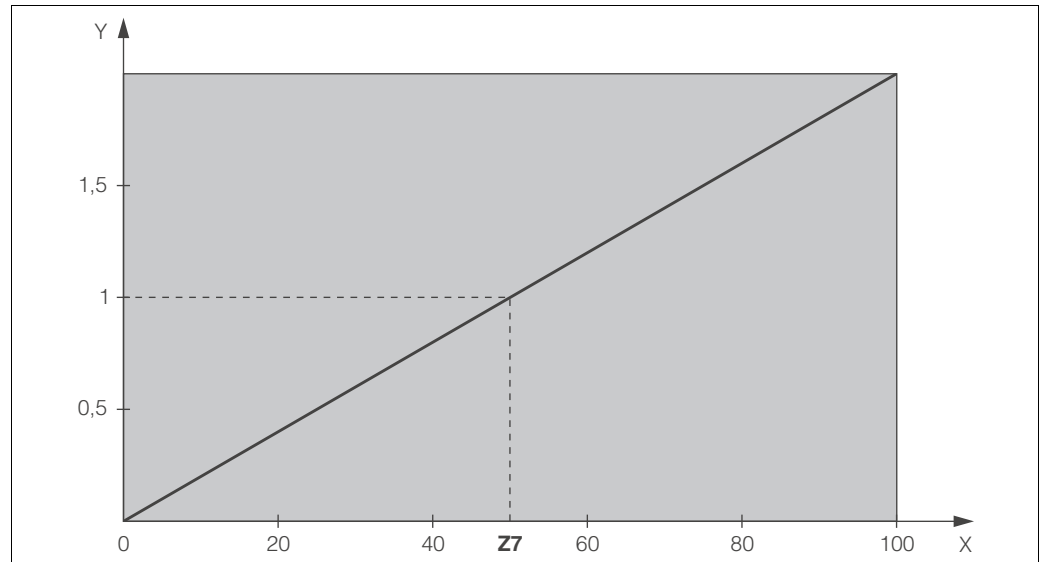
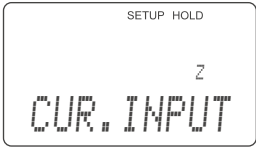
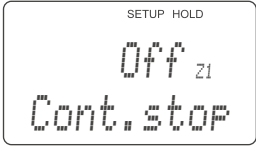
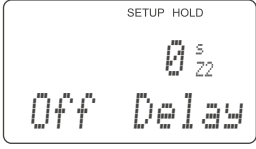
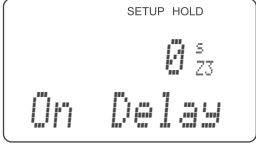
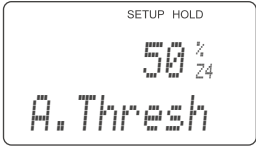
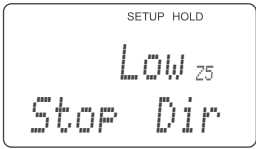
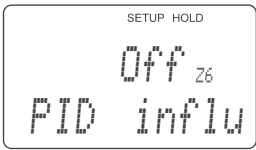
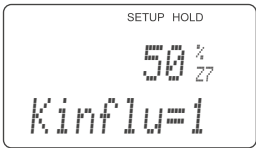

Fig. 34: Multiplying feedforward control

- | | |
|---|--------------------------|
| Y | Gain K_{mffl} |
| X | Current input signal [%] |

Coding	Field	Setting range (Factory settings, bold)	Display	Info
Z	CURRENT INPUT function group			Current input settings.
Z1	Select flow monitoring of main stream (with controller switch-off)	Off On		Flow monitoring may only be switched on if the flowmeter is connected in the main stream. If Z1 = off, fields Z2 to Z5 are not available.
Z2	Enter the delay for controller switch-off through current input	0 s 0 to 2000 s		Brief flow shortfalls can be suppressed by a delay and do not result in controller switch-off.
Z3	Enter the delay for controller switch-on through current input	0 s 0 to 2000 s		In the case of a controller, a delay until a representative measured value is received is useful if the flow fails for an extended period.
Z4	Enter the switch-off limit value for the current input	50% 0 to 100%		0 to 100% corresponds to 4 to 20 mA at the current input. Observe measured value assignment to the current output of the flowmeter.
Z5	Enter the switch-off direction for the current input	Low High		The controller is switched off if the value entered in Z4 is undershot or overshoot.
Z6	Select feedforward control to PID controller	Off Lin = linear Basic		If Z6 = off, the field Z7 is not available. Z6 = basic: disturbance variable only affects the basic load (alternatively dosing in proportion to quantity, if usual PID controller not possible, e.g. defective sensor).
Z7	Enter value for feedforward control at which gain = 1 applies	50% 0 to 100%		When the value is set, the controller actuating variable is the same size when feedforward control is switched on as when feedforward control is switched off.

6.6.4 Current outputs

Use the "Current output" function group to configure the individual outputs. You can enter either a linear characteristic (O3 (1)) or a user-defined current output characteristic in conjunction with the Plus Package (O3 (3)). Exception: if you have chosen a "continuous controller" for current output 2, you cannot enter a user-defined current output characteristic for this current output.

In addition, you can also simulate a current output value (O3 (2)) to check the current outputs.

If a second current output is present, you can output the controller actuating variable in accordance with field R 237 / R 266 via the current output.

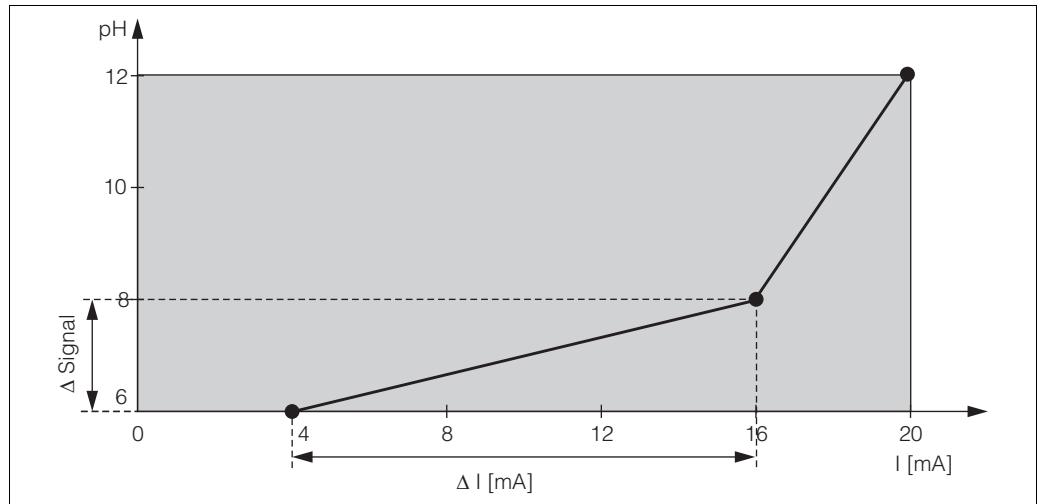

Fig. 35: User-defined current output characteristic (example)

The current output characteristic must be extremely monotonic increasing or extremely monotonic decreasing.

The distance per mA between two table value pairs must be greater than:

- pH: 0.03
- ORP: 5 mV
- Temperature: 0.25 °C

The values for the sample characteristic (→ 35) are entered in the following table. The distance per mA can be calculated from $\Delta \text{ signal} / \Delta \text{ mA}$.

Value pair	Current output 1			Current output 2		
	pH / mV / % / °C	Current [mA]	Distance per mA	pH / mV / % / °C	Current [mA]	Distance per mA
1	6	4				
2	8	16	0.166			
3	12	20	1.000			

First enter the desired current output configuration into the following blank table with a pencil. Calculate the resulting signal distance per mA to observe the necessary minimum slope. Then enter the values in the device.

Value pair	Current output 1			Current output 2		
	pH / mV / % / °C	Current [mA]	Distance per mA	pH / mV / % / °C	Current [mA]	Distance per mA
1						
2						
3						
4						
5						
6						
7						
8						
9						

Coding		Field	Setting range (Factory settings, bold)	Display	Info
0		CURRENT OUTPUT function group			Configuration of the current output (does not apply for PROFIBUS).
01		Select current output	Out1 Out 2		A characteristic can be selected for every output.
02		Select measured variable for 2nd current output	°C pH mV Contr		R237/R 266 = curr (current output 2) can only be selected if O2 = Contr is selected (relay board required).
03	03 (1)	Enter or output linear characteristic	Lin = linear (1) Sim = simulation (2) Tab = table (3)		The characteristic can have a positive or negative slope for the measured value output. In the case of actuating variable output (O2 = Contr), an increasing current corresponds to an increasing actuating variable.
		0311 Select current range	4 to 20 mA 0 to 20 mA		
		0312 0/4 mA value: Enter associated pH (ORP) or temperature value	pH 2.00 pH -2.00 to 16.00 -1500 mV -1500 to 1500 mV 0.0 % 0.0 to 100.0 % 0.0 °C -20 to 150.0 °C		Here you can enter the measured value at which the min. current value (0/4 mA) is applied at the transmitter output. (Spreading: see Technical data.)
		0313 20 mA value: Enter associated pH (ORP) or temperature value	pH 12.0 pH -2.00 to 16.00 1500 mV -1500 mV to 1500 mV 100.0 % 0.0 to 100.0 % 100.0 °C -20.0 to 150.0 °C		Here you can enter the measured value at which the max. current value (20 mA) is applied at the transmitter output. (Spreading: see Technical data.)
		03 (2)	Simulate current output	Lin = linear (1) Sim = simulation (2) Tab = table (3)	
		0321 Enter simulation value	Current value 0.00 to 22.00 mA		Entering a current value results in this value being directly output at the current output.

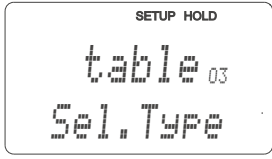
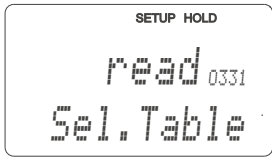
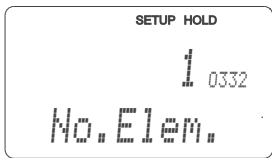
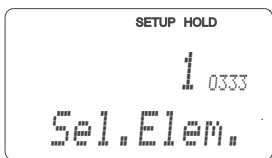
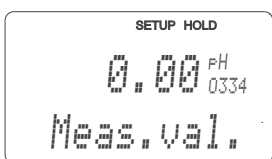
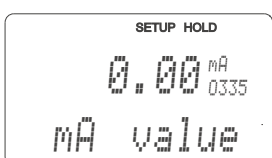
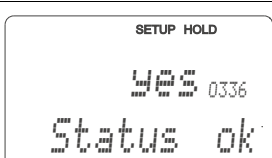
Coding	Field	Setting range (Factory settings, bold)	Display	Info
O3 (3)	Enter current output table (only for Plus Package)	Lin = linear (1) Sim = simulation (2) Tab = table (3)		Values can also be added or altered at a later stage. The values entered are automatically sorted by increasing current value. For further characteristics, see O3 (1), O3 (2).
	0331 Select table options	Read Edit		
	0332 Enter number of table value pairs	1 1 to 10		Enter the number of pairs from the x and y value (measured value and current value) here.
	0333 Select table value pair	1 1 to No. elem. Assign		
	0334 Enter x value	pH 0.00 pH -2.00 to 16.00 0 mV -1500 to 1500 mV 0.0 % 0.0 to 100.0 %		x value = measured value specified by user.
	0335 Enter y value	0.00 mA 0.00 to 20.00 mA		y value = current value belonging to O334 specified by user. Return to O333 until all values are entered.
	0336 Message as to whether table status is OK	yes no		Back to O3. If status = no, correct table (all settings made up until now are retained) or back to measuring mode (table is deleted).



6.6.5 Monitoring functions

You can use the monitoring functions to define various alarms and configure output contacts.

Each individual error can be defined to be effective or not (at the contact or as an error current). Moreover, the electrode can be checked for glass breakage or leak current (P1, P2, P7). In the event of an alarm, a cleaning function can also be activated (F8).

 You can only check for glass breakage or leak current and avail of the cleaning function in the Plus package.

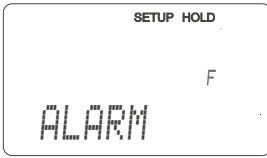
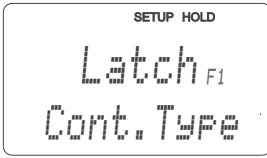
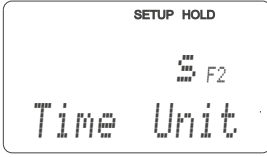
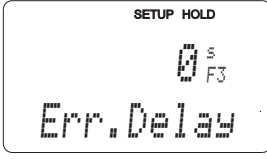
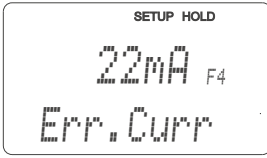
Alarm

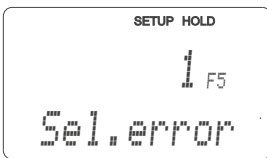
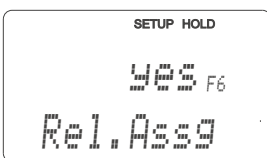
Coding	Field	Setting range (Factory settings, bold)	Display	Info
F	ALARM function group			Alarm function settings.
F1	Select contact type	Latch = latching contact Momen = momentary contact		The contact type selected only applies to the alarm contact.
F2	Select time unit	s min		
F3	Enter alarm delay	0 s (min) 0 to 2000 s (min)		Depending on the option selected in F2, the alarm delay is entered in s or min.
F4	Select error current	22 mA 2.4 mA		This selection must be made even if all error reporting is switched off in F5.  If "0-20 mA" was selected in O311, "2.4 mA" may not be used.
F5	Select error	1 1 to 255		Here you can select all the errors which should trigger an alarm. The errors are selected via the error numbers. Please refer to the table in section 9.2 "System error messages" for the meaning of the individual error numbers. The factory settings remain in effect for all errors not edited.
F6	Set alarm contact to be effective for the selected error	yes no		If "no" is selected, all the other alarm settings are deactivated (e.g. alarm delay). The settings themselves are retained. This setting only applies to the error selected in F5.

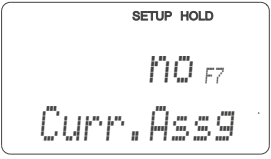
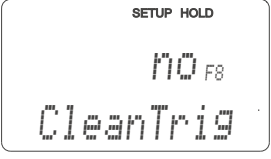
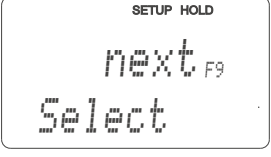
Coding		Field	Setting range (Factory settings, bold)	Display	Info
	F7	Set error current to be effective for the selected error	no yes		The option selected in F4 is effective or ineffective in the event of an error. This setting only applies to the error selected in F5.
	F8	<i>Automatic cleaning function start</i>	no yes		This field is not available for certain errors, see "Trouble-shooting and fault elimination" section.
	F9	Select return to menu or next error	next = next error ←R		If ←R is selected, you return to F, if next is selected, you go to F5.

Check

The CHECK function group is only available for devices with a Plus Package. In the CHECK function group, you can select two different monitoring functions for the measurement:

SCS electrode monitoring

The Sensor Check System monitors the pH and reference electrode for incorrect measurement and complete failure.

SCS identifies the following reasons for incorrect measurement:

- Electrode glass breakage
- Fine short circuits in the pH measuring circuit, also e.g. moisture or dirt bridges at terminal points
- Contamination or clogging of the reference electrode
- Leak current for ISFET sensor

The following three monitoring methods are used:

- Monitoring the pH electrode for high resistance (alarm if a minimum impedance is undershot, approx. 500 k Ω).
This function cannot be selected for antimony and ISFET electrodes (A4).
- Monitoring of impedance of the reference electrode (alarm if set threshold value overshoot).
This function can only be selected for symmetrically high-resistance measurement.
- Monitoring of leak current for ISFET sensors (pre-alert E168 at $I_{LEAK} > 200$ nA, error E008 at $I_{LEAK} > 400$ nA).

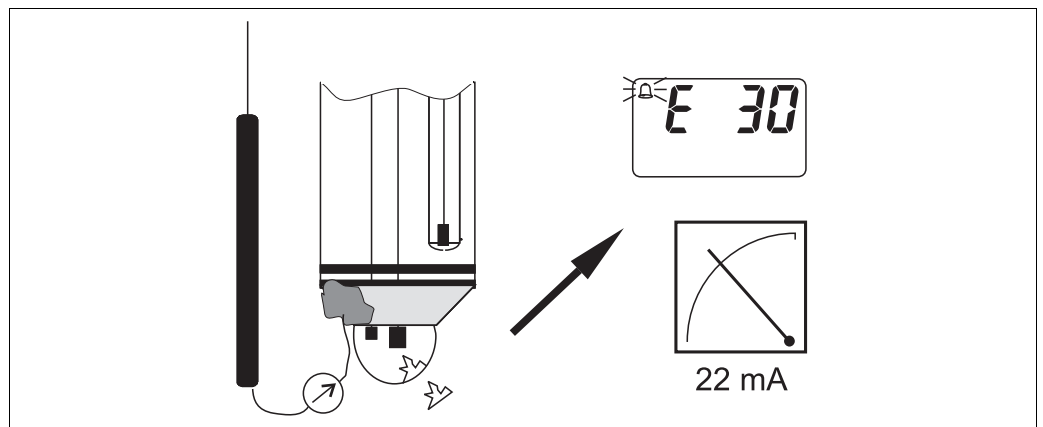

Fig. 36: SCS alarm

- i Do not remove the standard electrode from the process without Hold! Since SCS is measured against PML, no contact between the inner conductor and PML triggers an alarm. Digital sensors do not use PML.

PCS alarm (Process Check System)

The function AC is used to check measuring signals for deviations. If the measuring signal change within an hour is smaller than 0.5% (of full scale value of the selected measuring range), an alarm (E152) is triggered. The reason for such sensor behaviour can be contamination, cable rupture or similar.

You can monitor the controller activity with the function CC. A malfunction of the controller is detected and reported thanks to freely adjustable monitoring times (E154 - E157).

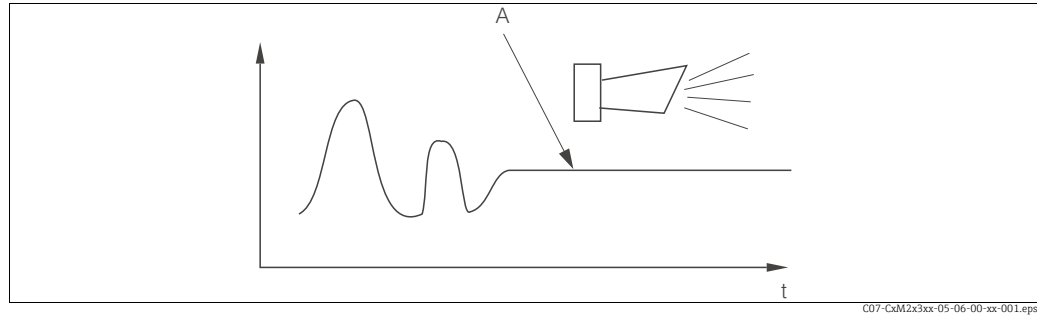

Fig. 37: PCS alarm (live check)

A Constant measuring signal = alarm triggered after PCS alarm time has elapsed

Pay attention to the following:

- The electrode must be symmetrically connected (with PML) to monitor the reference.
- Any PCS alarm pending is automatically deleted as soon as the sensor signal changes.
- Due to its semiconductor component, the ISFET sensor is sensitive to light and reacts with measured value fluctuations. For this reason, avoid direct sunlight when calibrating and operating. Normal ambient light does not have any effect on the measurement.

Alarm threshold monitoring

You can use this function to monitor the measured value for permissible upper and lower limits and trigger an alarm.

Coding	Field	Setting range (Factory settings, bold)	Display	Info
P	CHECK function group			Settings for electrode and process monitoring
P1	Switch SCS alarm for the measuring electrode on or off	Off On		Monitoring of electrode for glass breakage (error no.: E008). Response time approx. 30 s SCS glass warning (error no.: E175) SCS monitoring is not active during calibration.
P2	Switch SCS alarm for the reference electrode on or off	Off On		Monitoring of reference electrode for contamination or clogging (error no.: E030). Response time approx. 60 s SCS ref warning (error no.: E177) Only for A2 = sym.
P3	Enter SCS alarm threshold for reference electrode	50.0 kΩ 0.0 to 50 kΩ		The measurement result also contains the resistance of the medium. The impedance of the reference electrode increases with the degree of contamination. Not for Memosens
P4	Leak current display for ISFET sensor	Display only! 0.0 to 9.9 μA		Only if A4 = ISFET. Leak currents > 0.4 μA indicate damage to the ISFET sensor.

Coding	Field	Setting range (Factory settings, bold)	Display	Info
P5	Select alarm threshold monitoring	Off Low High LoHi = low + high Low! High! LoHi!		Alarm possible with or without controller switch-off. xxxx = without controller switch-off xxxx! = with controller switch-off
P6	Enter alarm delay	0 s (min) 0 to 2000 s (min)		Depending on the option selected in F2, the alarm delay is entered in s or min. Only once this time has elapsed does undershooting/overshooting in accordance with field P7 / P8 result in an alarm.
P7	Enter lower alarm threshold	-2.00 pH -2.00 to 16.00 pH		Not applicable when P5 = off.
P8	Enter upper alarm threshold	16.00 pH -2.00 to 16.00 pH		Not applicable when P5 = off.
P9	Select process monitoring (PCS alarm)	Off AC CC AC CC AC! CC! ACCC!		AC = sensor activity monitoring CC = controller monitoring Alarm possible with or without simultaneous controller switch-off. xxxx = without controller switch-off xxxx! = with controller switch-off
P10	Enter maximum permissible duration for alarm threshold undershoot	60 min 0 to 2000 min		Only for P9 = CC or AC CC.
P11	Enter maximum permissible duration for alarm threshold overshoot	120 min 0 to 2000 min		Only for P9 = CC or AC CC.
P12	Enter alarm threshold (for P10 / P11)	1.00 pH -2.00 to 16.00 pH		Set value is an absolute value. This function is primarily suited to batch operation and single-sided limit switches.

SCS operating voltage for pH sensors with Memosens functionality

If the connection between the pH sensor with Memosens functionality and cable is just connected but not locked, the supply voltage can drop below the required voltage value due to the poor coupling. This results in incorrect measurement.

With the SCS operating voltage, the supply voltage of a pH sensors with Memosens functionality is monitored.

If this value drops below the safety limit, the measured value is ignored and the error E 127 is output.

6.6.6 Relay contact configuration

To use the RELAY function group you need a relay board which is not part of the basic version.

The following relay contacts can be selected and configured as desired (max. four contacts, depending on options installed):

- Limit contactor for pH / ORP: R2 (1)
- Limit contactor for temperature: R2 (2)
- PID controller: R2 (3)
- Timer for cleaning function: R2 (4)
- Chemoclean function: R2 (5)
- Neutralization controller: R2 (6) (for Plus Package)

Limit contactor for measured pH / ORP and temperature

The transmitter has different ways of assigning a relay contact.

Switch-on and switch-off points and pick-up and drop-out delays can be assigned to the limit contactor. In addition, you can configure an alarm threshold to output an error message and to start a cleaning function in conjunction with this.

These functions can be used both for pH/ORP measurement and for temperature measurement.

Please refer to →  38 for a clear illustration of the relay contact states.

- When the measured values increase (maximum function), the relay contact is closed as of t_2 after the switch-on point (t_1) has been overshoot and the pick-up delay has elapsed ($t_2 - t_1$).
The alarm contact switches if the alarm threshold (t_3) is reached and the alarm delay ($t_4 - t_3$) has also elapsed.
- When the measured values decrease, the alarm contact is reset when the alarm threshold (t_5) is undershot as is the relay contact (t_7) after the drop-out delay ($t_7 - t_6$).
- If the pick-up and drop-out delays are set to 0 s, the switch-on and switch-off points are also switch points of the contacts.

Settings can also be made for a minimum function in the same way as for a maximum function.

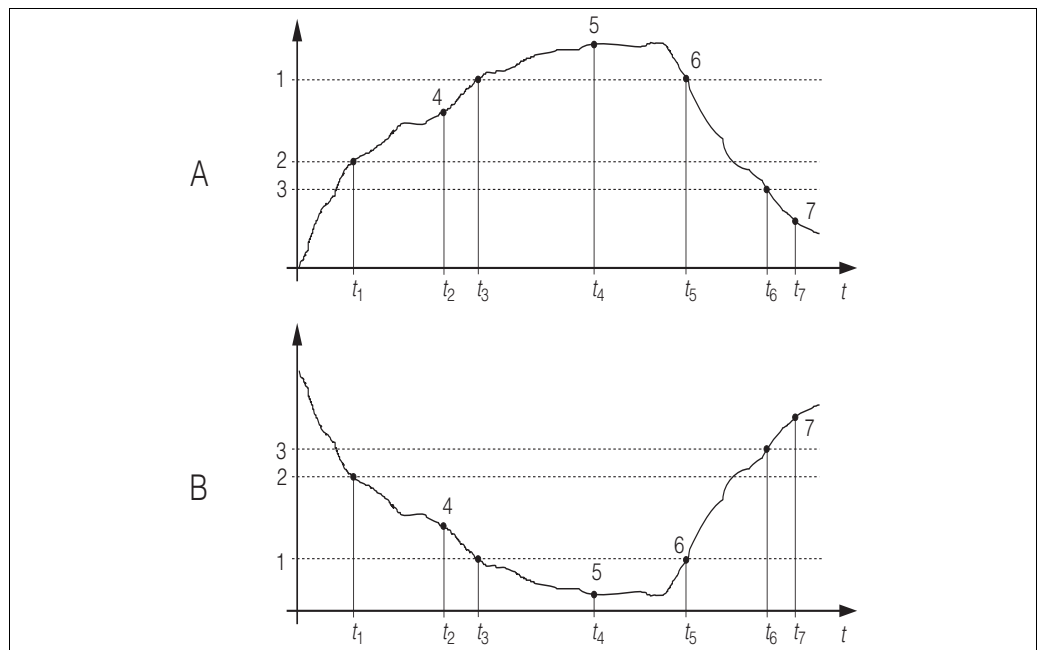

Fig. 38: Illustration of the alarm and limit value functions

A	Switch-on point > switch-off point: Max. function	1	Alarm threshold
B	Switch-on point < switch-off point: Min. function	2	Switch-on point
		3	Switch-off point
		4	Contact ON
		5	Alarm ON
		6	Alarm OFF
		7	Contact OFF

P(ID) controller

You can define various controller functions for the transmitter. On the basis of the PID controller, P, PI, PD and PID controllers can be implemented. For an optimum control system, use the controller that best suits your application. Depending on the option selected in the R 237/R 266 field, the actuating signal can be output via relays or via current output 2 (if available).

■ P controller

Used for simple linear control purposes with small system deviations. Where major changes are to be controlled, overshooting may occur. In addition, a lasting control deviation is to be expected.

■ PI controller

Is used for control systems where overshooting is to be avoided and no lasting control deviation should occur.

■ PD controller

Is used for processes that require quick changes and where peaks are to be corrected.

■ PID controller

Is used for processes where a P, PI or PD controller does not control sufficiently.

Configuration options of the PID controller

The following configuration options are available for a PID controller:

- Change control gain K_p (P influence)
- Set integral action time T_n (I influence)
- Set derivative action time T_v (D influence)

Basic load dosing (Basic)

The basic load dosing (field R231) is used to set a constant dosage (field R2311)

PID controlling plus basic load dosing

If you select this function (PID + Basic) in field R231 the PID controlled dosage will not be lower than the basic load value entered in field R2311.

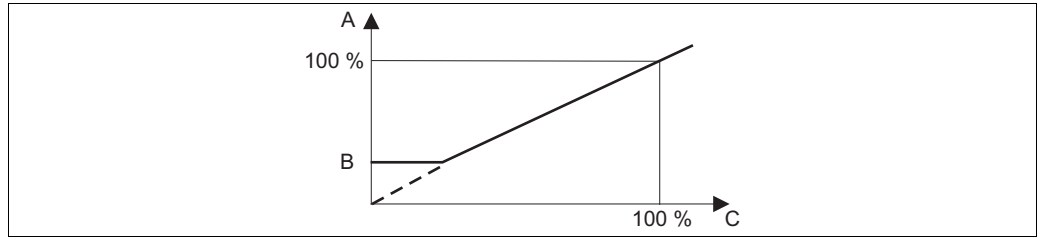

Fig. 39: Control characteristic PID controller with basic load dosing

- A PID with basic load
- B Basic load
- C PID

Commissioning

If you do not yet have any experience for setting the control parameters, set the values that yield the greatest possible stability in the control circuit. Proceed as follows to optimize the control circuit further:

- Increase the control gain K_p until the controlled variable just starts to overshoot.
- Reduce K_p slightly and then reduce the integral action time T_n so that the shortest possible correction time without overshooting is achieved.
- To reduce the response time of the controller, also set the derivative action time T_v .

Control and fine optimization of the set parameters with a recorder

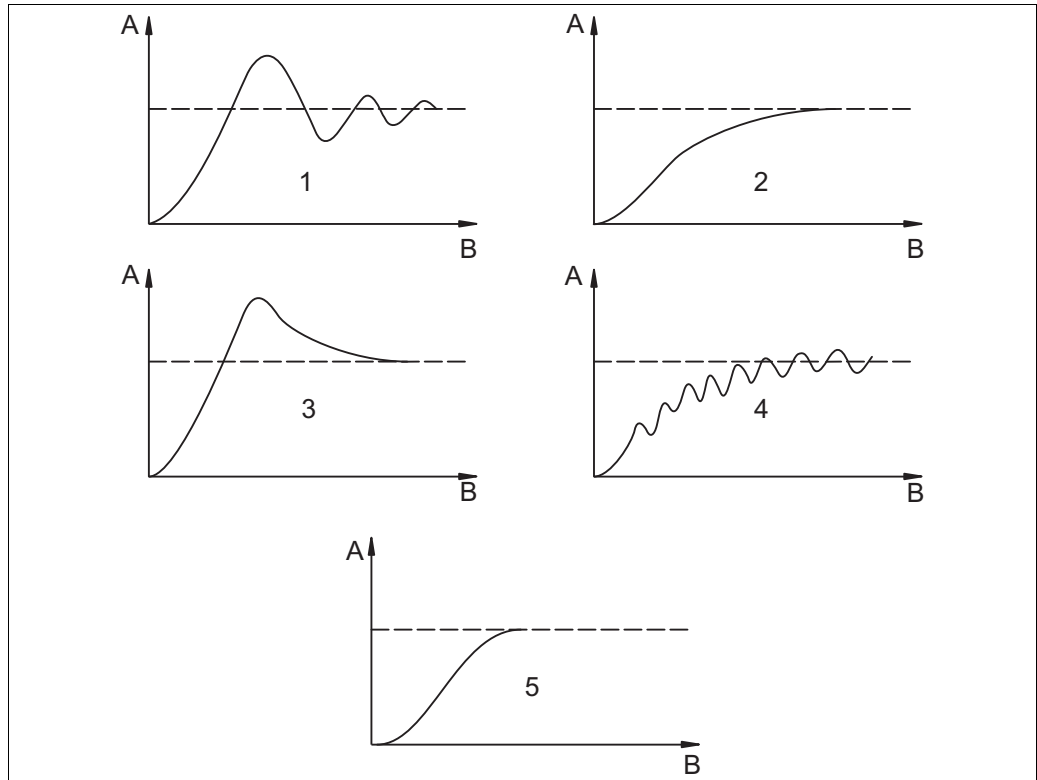

Optimization of settings T_n and K_p

- | | | | | | |
|---|--------------|---|-----------------|---|-----------------|
| A | Actual value | 1 | T_n too small | 4 | K_p too small |
| B | Time | 2 | T_n too large | 5 | Optimum setting |
| | | 3 | K_p too large | | |

Actuating signal outputs (R237 to R2310)

Each control contact outputs a cyclical signal whose intensity corresponds to the controller's manipulated variable. A distinction is made according to the type of signal cycle:

- Pulse length modulation
The bigger the calculated manipulated variable is, the longer the contact affected remains picked up. The period T can be adjusted between 0.5 and 99 s (field R238). Outputs with pulse length modulation are used to activate solenoid valves.
- Pulse frequency modulation
The bigger the calculated manipulated variable is, the higher the switching frequency of the contact affected. The maximum switching frequency $1/T$ can be set between 60 and 180 min^{-1} . The on-time t_{ON} is constant. It depends on the set maximum frequency and is approx. 0.5 s for 60 min^{-1} and approx. 170 ms for 180 min^{-1} . Outputs with pulse frequency modulation are used to activate directly controlled solenoid dosing pumps.

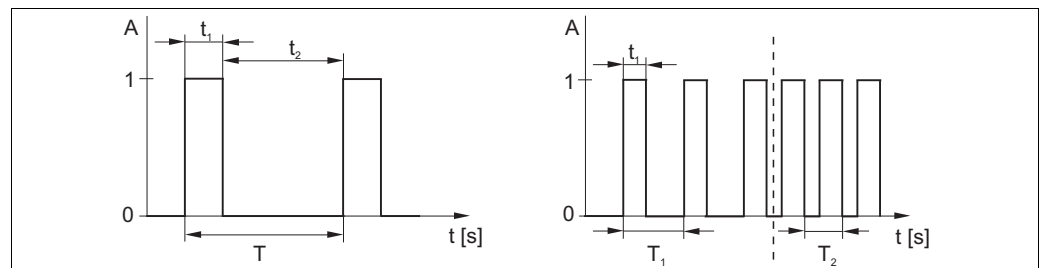

Fig. 40: Signal of a pulse-length modulated controller contact (left) and of a pulse-frequency modulated controller contact (right)
 A Contact 1 = on, 0 = off
 T Period length
 B Time [s] $t_1 = t_{on}$ $t_2 = t_{off}$
 T_1 T_2 Impulse period length (impulse freq. $1/T_1$ and $1/T_2$)

Constant controller

Via the current output 2, the minimum actuating variable (0 %) of the controller is output with 0/4 mA and the maximum actuating variable (100%) of the controller is output with 20 mA.

Control characteristic for direct and inverse control action

You can choose between two control characteristics in the R236 field:

- Direct control action = maximum function
- Inverse control action = minimum function

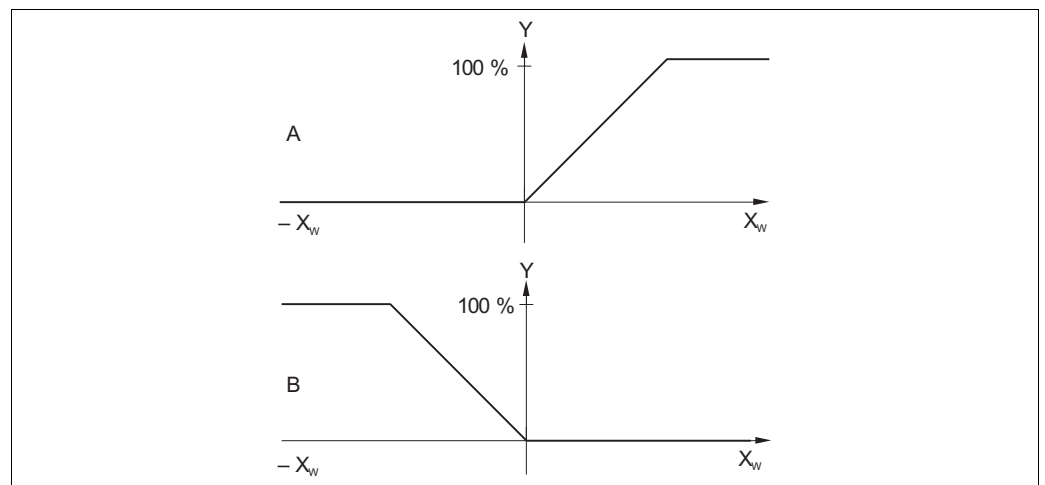

Fig. 41: Control characteristic of a proportional controller with direct and inverse control action
 A Direct = max. function
 B Inverse = min. function

Timer for cleaning function

This function includes a simple cleaning option. You can set the time interval after which cleaning should start. So you can only select a constant interval sequence. Other cleaning functions are available for selection in conjunction with the Chemoclean function (version with four contacts, see "Chemoclean function" section).

i Timer and Chemoclean do not work independently of one another. While one of the two functions is active, the other cannot be started.

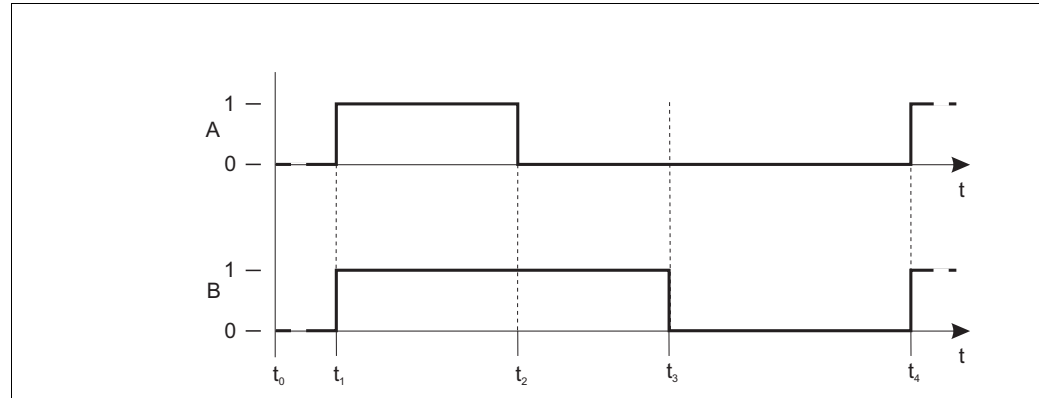

Fig. 42: Correlation of cleaning time, pause time and hold dwell period

A	Wiper and/or spray cleaning system	t_0	Normal mode
B	Hold function	t_1	Cleaning start
0	Inactive	$t_2 - t_1$	Cleaning time
1	Active	$t_3 - t_2$	Clean hold dwell period (0 to 999 s)
		$t_4 - t_3$	Pause time between two cleaning intervals (1 to 7200 min)

Chemoclean function

Just like the timer function, Chemoclean can also be used to start a cleaning cycle. However, Chemoclean also gives you the added option of defining different cleaning and rinsing intervals.

As a result, it is possible to clean irregularly with different repeat cycles and to separately set the cleaning times with post rinse times.

Pay attention to the following:

- To use the Chemoclean function the transmitter has to be equipped with a designated relay board (see product structure or chapter "accessories").
- Timer and Chemoclean do not work independently of one another. While one of the two functions is active, the other cannot be started.
- For the Chemoclean function, the relays 3 (water) and 4 (cleaner) are used.
- If cleaning is prematurely aborted, a post rinse time always follows.
- If the setting is "Economy", cleaning only takes place with water.

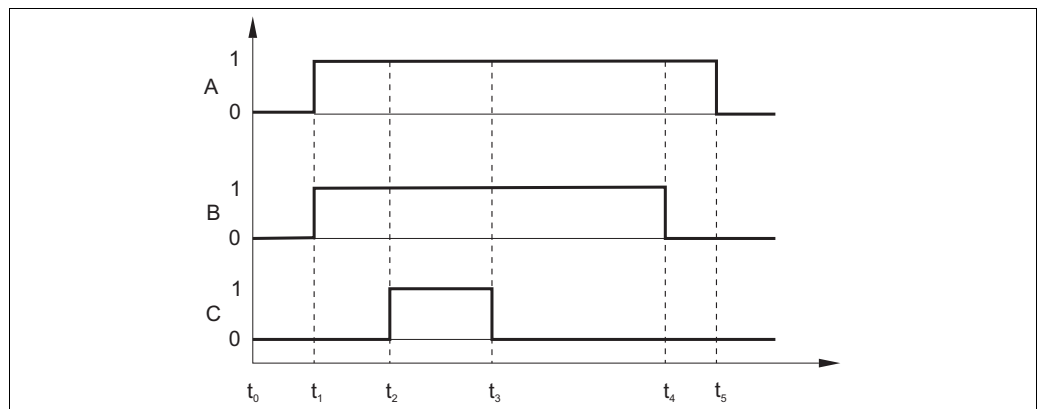

Fig. 43: Sequence of a cleaning cycle

- | | | | |
|---|-------------|-------------|-------------------|
| A | Hold | t_0 | Normal mode |
| B | Water | t_1 | Cleaning start |
| C | Cleaner | $t_2 - t_1$ | Pre-rinse time |
| 0 | Contact on | $t_3 - t_2$ | Cleaning time |
| 1 | Contact off | $t_4 - t_3$ | Post rinse time |
| | | $t_5 - t_4$ | Hold dwell period |

Neutralization controller

During neutralization control, the pH value of a medium is kept constant by dosing acid and alkali. Two separate actuating signals are required for this task, one for acid and one for alkali.

The neutralization controller is a controller with two relay contacts and is specially designed for this task. The P(ID) controller is available as the controller.

The values for the control gain K_p for acid and alkali can be set separately. Integral action time T_n and derivative action time T_v apply to both controllers (see "P(ID) controller" section). The "neutral Zone" is located between the set values 1 and 2. There is no acid or alkali dosing ($Y = 0$, see Fig. 44) in the "neutral zone" with a controller without integral components (P, PD). In the case of a controller with an integral component (PI, PID), there is constant alkali/acid dosing ($Y_{new} = Y_{old}$). The behaviour of the I-component within the neutral zone depends on the process type (inline/batch).

The "neutral zone" can be shifted as desired in the X direction via set point 1 and 2.

i Neutralisation control is only possible with relays 1 and 2.

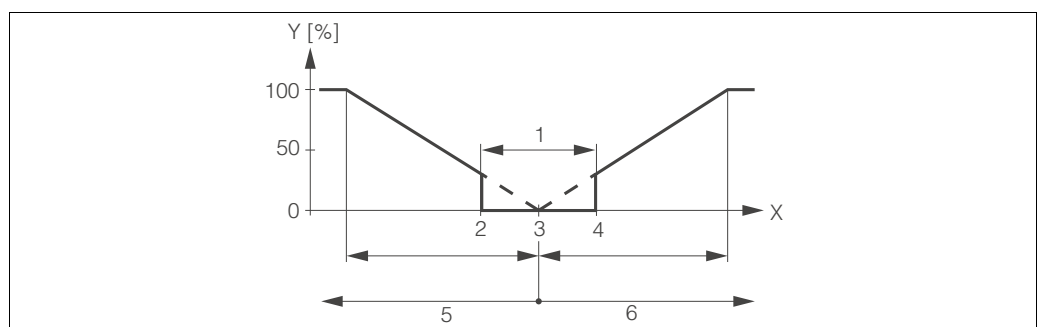

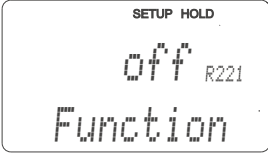
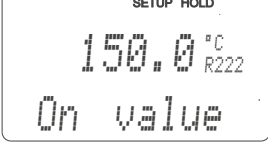
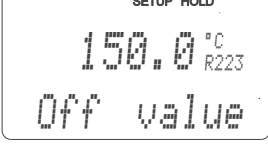
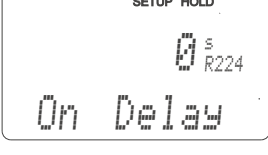
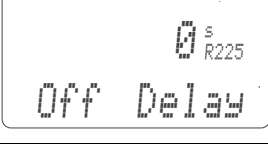
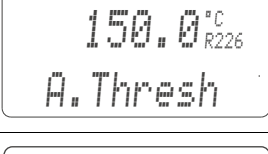
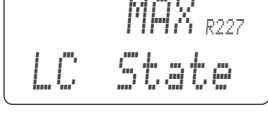

Fig. 44: Control characteristic of a proportional neutralization controller





- | | | | |
|---|--------------|---|------------------------------|
| 1 | Neutral zone | 4 | Set point 2 |
| 2 | Set point 1 | 5 | Control contact 1 for alkali |
| 3 | Set point | 6 | Control contact 2 for acid |

Coding	Field	Setting range (Factory settings, bold)	Display	Info
R	RELAY function group			Relay contact settings.
R1	Select contact to be configured	Rel1 Rel2 Rel3 Rel4		Rel3 (water) and Rel4 (cleaner) are only available with the relevant version of the transmitter. If Chemoclean is used as the cleaning method, Rel4 is not available.
R2 (1)	Configure limit contactor for pH/ORP measurement	LC PV = limit contactor pH/ORP (1) LC C = limit contactor T (2) PID controller (3) Timer (4) <i>Clean = Chemoclean (5)</i> <i>Neutra controller (6)</i>		PV = process value If Rel4 is selected in the R1 field, Clean = Chemoclean cannot be selected. By confirming with ENTER, another relay function already switched on is switched off and its settings are reset to the factory settings.
R211	Switch function of R2 (1) off or on	Off On		All the settings are retained.
R212	Enter the switch-on point of the contact	pH 16.00 pH -2.00 to 16.00 1500 mV -1500 to 1500 mV 100.0 % 0.0 to 100.0 %		Never set the switch-on point and the switch-off point to the same value! (Only the operating mode selected in A1 is displayed.)
R213	Enter the switch-off point of the contact	pH 16.00 pH -2.00 to 16.00 1500 mV -1500 mV to 1500 mV 100.0 % 0.0 to 100.0 %		Entering a switch-off point selects either a Max contact (switch-off point < switch-on point) or a Min contact (switch-off point > switch-on point), thereby implementing a hysteresis that is constantly required (see "Illustration of the alarm and limit functions" figure).
R214	Enter pick-up delay	0 s 0 to 2000 s		
R215	Enter drop-out delay	0 s 0 to 2000 s		
R216	Enter alarm threshold	pH 16.00 pH -2.00 to 16.00 1500 mV -1500 to 1500 mV 100.0 % 0.0 to 100.0 %		If the alarm threshold is undershot/overshot, this triggers an alarm with the error message and error current at the transmitter (note alarm delay in field F3). If defined as a Min contact, the alarm threshold must be < switch-off point.

Coding		Field	Setting range (Factory settings, bold)	Display	Info
	R217	Display status for limit contactor	MAX MIN		Display only.
	R2 (2)	Configure limit contactor for temperature measurement	LC PV = limit contactor pH/ ORP (1) LC C = limit contactor T (2) PID controller (3) Timer (4) <i>Clean = Chemoclean (5)</i> <i>Neutra controller</i>		By confirming with ENTER, another relay function already switched on is switched off and its settings are reset to the factory settings.
	R221	Switch function of R2 (2) off or on	Off On		
	R222	Enter switch-on temperature	150.0 °C -50.0 to 150.0 °C		Never set the switch-on point and the switch-off point to the same value!
	R223	Enter switch-off temperature	150.0 °C -50.0 to 150.0 °C		Entering a switch-off point selects either a Max contact (switch-off point < switch-on point) or a Min contact (switch-off point > switch-on point), thereby implementing a hysteresis that is constantly required (see "Illustration of the alarm and limit functions" figure).
	R224	Enter pick-up delay	0 s 0 to 2000 s		
	R225	Enter drop-out delay	0 s 0 to 2000 s		
	R226	Enter alarm threshold (as absolute value)	150.0 °C -50.0 to 150.0 °C		If the alarm threshold is undershot/overshot, this triggers an alarm with the error message and error current at the transmitter (note alarm delay in field F3). If defined as a Min contact, the alarm threshold must be < switch-off point.
	R227	Display status for limit contactor	MAX MIN		Display only.

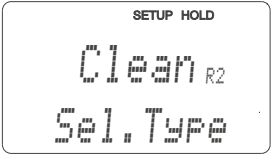
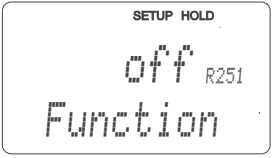
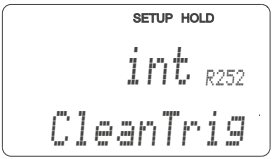
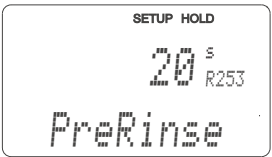
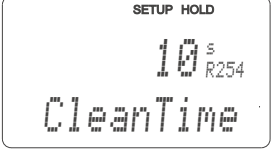
Coding	Field	Setting range (Factory settings, bold)	Display	Info
R2 (3)	Configure P(ID) controller	LC PV = limit contactor pH/ORP (1) LC C = limit contactor T (2) PID controller (3) Timer (4) <i>Clean = Chemoclean (5)</i> <i>Neutra controller</i>	<p>SETUP HOLD PID R2 Sel.Type</p>	By confirming with ENTER, another relay function already switched on is switched off and its settings are reset to the factory settings.
R231	Switch function of R2 (3) off or on	Off On Basic PID+B	<p>SETUP HOLD off R231 Function</p>	On = PID controller Basic = basic load dosing PID+B = PID controller + basic load dosing
R232	Enter set point	pH 16.00 pH -2.00 to 16.00 1500 mV -1500 to 1500 mV 0.0 % 0.0 to 100.0 %	<p>SETUP HOLD 16.00^{pH} R232 Setpoint</p>	The set point is the value to be maintained by the control system. Using this control process, this value is restored upwards or downwards when a deviation occurs.
R233	Enter control gain K _p	1.00 0.01 to 20.00	<p>SETUP HOLD 1.00 R233 Kp</p>	See "P(ID) controller" section.
R234	Enter integral action time T _n (0.0 = no I-component)	0.0 min 0.0 to 999.9 min	<p>SETUP HOLD 0.0^{min} R234 Time Tn</p>	See "P(ID) controller" section. With every Hold, the I-component is set to zero. Although Hold can be deactivated in field S2, this does not apply for Chemoclean and timer!
R235	Enter derivative action time T _v (0.0 = no D-component)	0.0 min 0.0 to 999.9 min	<p>SETUP HOLD 0.0^{min} R235 Time Tv</p>	See "P(ID) controller" section.
R236	Select controller characteristic	dir = direct Inv = inverse	<p>SETUP HOLD dir R236 Direction</p>	The setting is required depending on the control deviation (upward or downward deviation, see "Chemoclean function" section).
R237	Select pulse length or pulse frequency	len = pulse length Freq = pulse frequency Curr = current output 2	<p>SETUP HOLD len R237 Oper.Mode</p>	Pulse length e.g. for solenoid valve, pulse frequency e.g. for solenoid dosing pump, see "Actuating signal outputs" section. Curr = current output 2 can only be selected if O2 = Contr.
R238	Enter pulse interval	10.0 s 0.5 to 999.9 s	<p>SETUP HOLD 10.0^s R238 PulsePer.</p>	This field only appears if pulse length is selected in R237. If pulse frequency is selected, R238 is skipped and entries continue with R239.

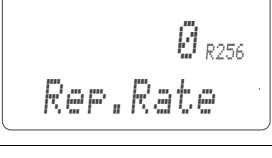
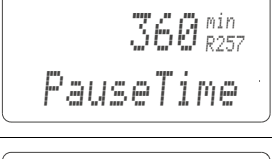
Coding		Field	Setting range (Factory settings, bold)	Display	Info
	R239	Enter maximum pulse frequency of the adjuster	120 min⁻¹ 60 to 180 min ⁻¹		This field only appears if pulse frequency is selected in R237. If pulse length is selected, R239 is skipped and entries continue with R2310.
	R2310	Enter minimum switch-on time t _{ON}	0.3 s 0.1 to 5.0 s		This field only appears if pulse length is selected in R237.
	R2311	Enter basic load	0 % 0 to 40 %		When you select the basic load, you enter the desired dosing quantity. 100% basic load corresponds to: - Constantly on for R237 = len - Fmax at R237 = feq - 20 mA at R237 = curr
	R2312	Enter process type	Batch Inlne		Batch = discontinuous process Inlne = continuous process There is no further dosing in the setting range in batch mode. The I-component is decreased. Dosing continues in the setting range in inline mode. The I-component is effective.
R2 (4)		Configure cleaning function (timer)	LC PV = limit contactor pH/ ORP (1) LC C = limit contactor T (2) PID controller (3) Timer (4) Clean = Chemoclean (5) Neutra controller (6)		Cleaning only takes place with a cleaning agent (usually water); see Fig. 41). By confirming with ENTER, another relay function already switched on is switched off and its settings are reset to the factory settings.
	R241	Switch function of R2 (4) off or on	Off On		
	R242	Enter rinsing/cleaning time	30 s 0 to 999 s		Settings for Hold and relay are active for this time.
	R243	Enter pause time	360 min 1 to 7200 min		The pause time is the time between two cleaning cycles (see "Timer for cleaning function" section).
	R244	Enter minimum pause time	120 min 1 to R243 min		The minimum pause time prevents constant cleaning if a cleaning trigger is present.

Coding	Field	Setting range (Factory settings, bold)	Display	Info
R2 (5)	Configure cleaning with Chemoclean (for version with four contacts and contacts 3 and 4 assigned)	LC PV = limit contactor pH/ORP (1) LC C = limit contactor T (2) PID controller (3) Timer (4) Clean = Chemoclean (5) Neutra controller (6)		See "Chemoclean function" section. By confirming with ENTER, another relay function already switched on is switched off and its settings are reset to the factory settings.
R251	Switch function of R2 (5) off or on	Off On		
R252	Select type of start pulse	Int = internal (time-controlled) Ext = external (digital input 2) I+ext = internal + external I+stp = internal, suppressed by external		The cycle for the "int" function is started by the end of the pause time (R257). No real time clock is available. External suppression is required for irregular time intervals (e.g. weekends).
R253	Enter pre-rinse time	20 s 0 to 999 s		Rinsing with water takes place.
R254	Enter cleaning time	10 s 0 to 999 s		Cleaning with cleaning agent and water takes place.
R255	Enter post rinse time	20 s 0 to 999 s		Rinsing with water takes place.
R256	Enter number of repeat cycles	0 0 to 5		R253 to R255 is repeated.
R257	Enter pause time	360 min 1 to 7200 min		The pause time is the time between two cleaning cycles (see "Timer function" section).
R258	Enter minimum pause time	120 min 1 to R257 min		The minimum pause time prevents constant cleaning if an external cleaning start is present.

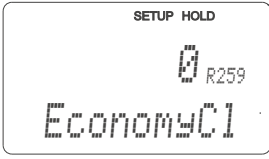
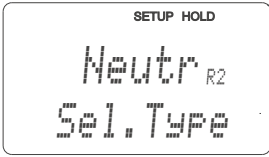
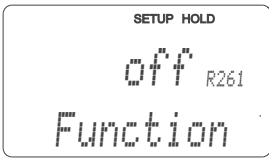
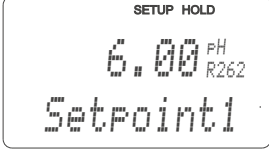
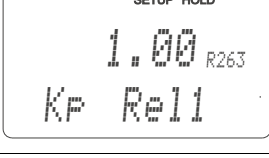
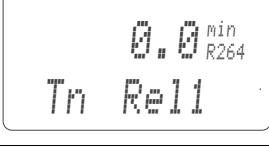
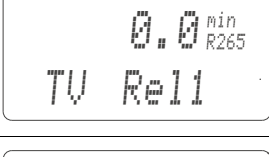
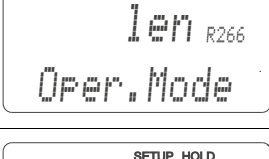
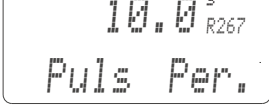
Coding		Field	Setting range (Factory settings, bold)	Display	Info
	R259	Enter number of cleaning cycles without cleaning agent (economy function)	0 0 to 9		After cleaning with cleaner, up to 9 cleaning sessions can be carried out with water only until the next cleaning session with cleaner takes place.
	R2 (6)	Configure neutralisation controller	LC PV = limit contactor pH/ORP (1) LC C = limit contactor T (2) PID controller (3) Timer (4) <i>Clean = Chemoclean (5)</i> Neutra controller (6)		Only for A1 = pH. If neutra controller is selected for Rel1, only neutra controller is offered for Rel2. By confirming with ENTER, another relay function already switched on is switched off and its settings are reset to the factory settings.
	R261	Switch function of R2 (6) off or on	Off On		
	R262	Enter set point 1 (or 2)	pH 6.00 pH -2.00 to 16.00		Relay assignment 1 and 2 for neutra controller: Rel1 = set point 1 Rel2 = set point 2
	R263	Enter relay switching capacity K _p 1 (or K _p 2)	1.00 0.10 to 20.00		Relay assignment 1 and 2 for neutra controller: Rel1 = Kp1 Rel2 = Kp2
	R264	Enter integral action time T _n 1 (or T _n 2) (0.0 = no I-component)	0.0 min 0.0 to 999.9 min		Relay assignment 1 and 2 for neutra controller: Rel1 = Tn1 Rel2 = Tn2
	R265	Enter derivative action time T _v 1 (or T _v 2) (0.0 = no D-component)	0.0 min 0.0 to 999.9 min		Relay assignment 1 and 2 for neutra controller: Rel1 = Tv1 Rel2 = Tv2
	R266	Select pulse length or pulse frequency	Len = pulse length Freq = pulse frequency Curr = current output 2		Pulse length e.g. for solenoid valve, pulse frequency e.g. for solenoid dosing pump, see "Actuating signal outputs" section. Curr = current output 2 can only be selected if O2 = Contr.
	R267	Enter pulse interval	10.0 s 0.5 to 999.9 s		This field only appears if pulse length is selected in R266. If pulse frequency is selected, R267 is skipped and entries continue with R268.

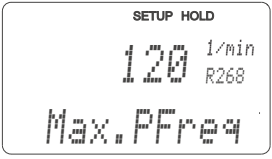
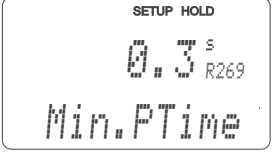
Coding		Field	Setting range (Factory settings, bold)	Display	Info
	R268	Enter maximum pulse frequency of the adjuster	120 min⁻¹ 60 to 180 min ⁻¹		This field only appears if pulse frequency is selected in R266. If pulse length is selected, R268 is skipped and entries continue with R269.
	R269	Enter minimum switch-on time t_{ON}	0.3 s 0.1 to 5.0 s		This field only appears if pulse length is selected in R266.
	R2610	Enter process type	Batch Inlne		Batch = discontinuous process Inlne = continuous process There is no further dosing in the setting range in batch mode. The I-component is decreased. Dosing continues in the setting range in inline mode. The I-component is effective.

6.6.7 Service

Coding	Field	Setting range (Factory settings, bold)	Display	Info
S	SERVICE function group			Service function settings.
S1	Select language	ENG = English GER = German FRA = French ITA = Italian NL = Dutch ESP = Spanish		This field has to be configured once during device configuration. Then you can exit S1 and continue.
S2	Configure Hold	S+C = Hold during configuration and calibration Cal = Hold during calibration Setup = Hold during configuration None = no Hold		S = setup C = calibration
S3	Manual Hold	Off On		The setting is retained even in the event of a power failure.
S4	Enter Hold dwell period	10 s 0 to 999 s		
S5	Enter SW upgrade release code (Plus Package)	0000 0000 to 9999		If an incorrect code is entered, you are taken back to the measurement menu. The number is edited with the PLUS or MINUS key and confirmed with the ENTER key. "1" is displayed if the code is active.
S6	Enter SW upgrade release code Chemoclean	0000 0000 to 9999		If an incorrect code is entered, you are taken back to the measurement menu. The number is edited with the PLUS or MINUS key and confirmed with the ENTER key. "1" is displayed if the code is active.
S7	Order number is displayed			If the device is upgraded, the order code is automatically adjusted.
S8	Serial number is displayed			

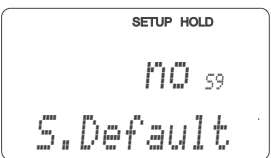
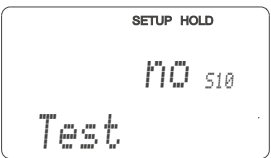
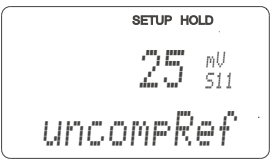
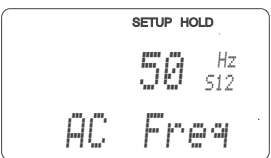
Coding	Field	Setting range (Factory settings, bold)	Display	Info
S9	Reset the device to the basic settings 	No Sens = sensor data Facyt = factory settings		Sens = last calibration is deleted and is reset to factory setting. Facyt = all data (apart from A1 a. S1) are deleted and reset to the factory setting!
S10	Perform device test	No Displ = display test		
S11	Reference voltage is displayed	Current value in mV		This is used to check the reference potential. Value > 50 mV indicates galvanic voltage in the medium. High values (> 1000 mV) may falsify the measured value.
S12	Select AC frequency	50 Hz 60 Hz		Only select 60 Hz if the frequency of the voltage at the place of use is 60 Hz, the measured value is fluctuating or sporadic SCS errors are reported.

6.6.8 E+H Service

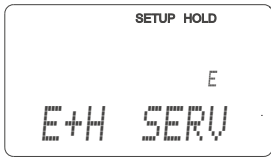
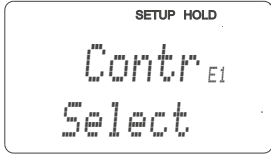
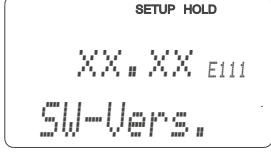
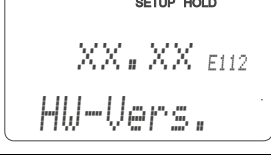
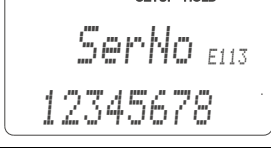
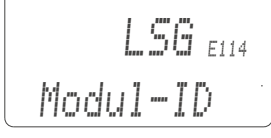
Coding	Field	Setting range (Factory settings, bold)	Display	Note
E	E+H SERVICE function group			Information on the device version
E1	Select module	Contr = controller (1) Trans = transmitter (2) Main = power unit (3) Rel = relay module (4) Sens = sensor (5)		The "Sens = sensor" option is only available on devices with Memosens functionality.
	E111 E121 E131 E141 E151	Software version is displayed		If E1 = contr: instrument software If E1 = trans, main, rel: module firmware If E1 = sens: sensor software
	E112 E122 E132 E142 E152	Hardware version is displayed		Only display function
	E113 E123 E133 E143 E153	Serial number is displayed		Only display function
	E114 E124 E134 E144 E154	Module ID is displayed		Only display function

6.6.9 Interfaces

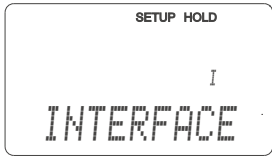
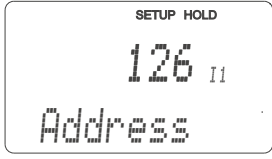
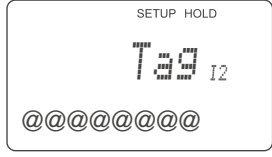
Coding	Field	Setting range (Factory settings, bold)	Display	Info
I	INTERFACE function group			Communication settings (only for device version HART or PROFIBUS).
I1	Enter bus address	Address HART: 0 to 15 or PROFIBUS: 0 to 126		Each address may only be used once in a network. If a device address ≠ 0 is selected, the current output is automatically set to 4 mA and the device is set to multi-drop operation.
I2	Display of measuring point			

6.7 Communication

For devices with a communication interface, please also refer to the separate Operating Instructions BA00208C/07/EN (HART) or BA00209C/07/EN (PROFIBUS).

6.8 Calibration

Use the CAL key to access the calibration function group.

Use this function group to calibrate the sensor. The calibration can take place in a number of ways:

- By measuring in two calibration solutions with known pH value.
- By entering data for the slope and zero point
- In the case of ORP measurement, by entering the mV value or two different % values

Pay attention to the following:

- During commissioning, calibration is absolutely essential (except for sensors with Memosens functionality) so that the measuring system can return precise measurement data.
- If the calibration is aborted by simultaneously pressing the PLUS and MINUS keys (return to C19, C25 or C36), or if the calibration is faulty, the original calibration data are used again. A calibration error is indicated by "ERR" and the sensor symbol flashes on the display.
Repeat calibration!
- For each calibration, the device automatically switches to Hold (factory setting).
- Any offset set is automatically deleted after the calibration is accepted.
- If the slope or zero point are outside the ranges given in C16 and C17, error 32 becomes active for slope or error 33 becomes active for zero point. The electrode must then be checked and replaced if necessary.
- If precalibrated digital sensors (Memosens functionality) are connected, the calibration data are automatically transmitted to the transmitter.

Things to note elements when calibrating ISFET sensors

Switch-on behaviour

A control circuit is created when the measuring system is switched on. During this time (approx. 5 to 8 minutes), the measured value adjusts to the real value. This settling behaviour occurs every time the liquid film between the pH-sensitive semi-conductor and the reference lead is interrupted (e.g. caused by dry storage or intensive cleaning with compressed air). The settling time depends on the length of the interruption.

Sensitivity to light

Like all semi-conductor elements, the ISFET chip is sensitive to light (measured value fluctuations). However, this only affects the measured value if the sensor is directly exposed to sunlight. For this reason, avoid direct sunlight when calibrating. Normal ambient light does not have any effect on the measurement.

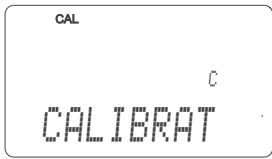
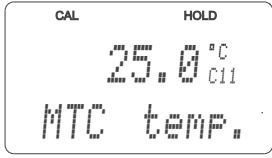
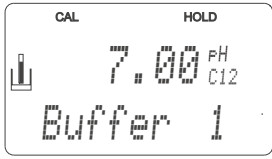
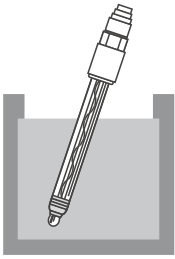
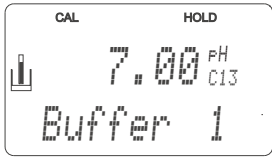
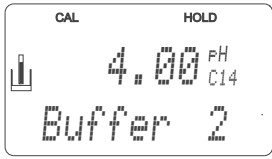
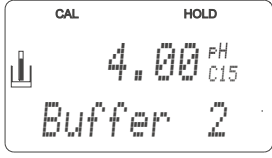
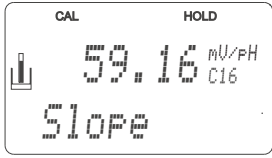
Coding		Field	Setting range (Factory settings, bold)	Display	Info
C (1)		CALIBRATION function group	Calibration pH		Only for A1 = pH. Calibration with two different buffer solutions.
	C11	Enter calibration temperature	25.0 °C -50.0 to 150.0 °C		Only for B1 = MTC.
	C12	Enter pH value of the first buffer solution	Buffer value of the last calibration pH 0.00 to 14.00		You can edit the displayed value. The value is given by the corresponding buffer solution.
Insert the electrode into the buffer indicated. In the case of ATC operation, the temperature sensor must also be immersed in the buffer solution. Press CAL for the current measured value to be displayed. Then start the calibration by pressing CAL again.					In the case of symmetrical measuring operation, the potential matching pin must also be immersed in the buffer.
	C13	Calibration is performed Display flashes			Stability check: The value is accepted in the event of stability $\leq \pm\text{pH } 0.05$ for more than 10 s.
<ol style="list-style-type: none"> Manual continuation: if the value becomes stable, you can accept the calibration for buffer solution 1 with the CAL key. Automatic continuation: takes place if the value is stable (difference between measured values ≤ 0.05 and constant value over 10 s). If the value does not stabilise within 5 min, error 44 is set and the calibration is aborted. 					
	C14	Enter pH value of the second buffer solution	Buffer value of the last calibration pH 0.00 to 14.00		The buffer must have another pH value than buffer 1. A plausibility check takes place.
Proceed with buffer 2 as with buffer 1.					
	C15	Calibration is performed Display flashes			Accepted in the event of stability $\leq \pm\text{pH } 0.05$ for more than 10 s.
	C16	Slope is displayed	Usual values Glass: 59.16 mV/pH 38.00 to 65.00 mV/pH Antimony: 59.16 mV/pH 25.00 to 65.00 mV/pH ISFET: 59.16 mV/pH 38.00 to 65.00 mV/pH		
Press CAL.					

Coding		Field	Setting range (Factory settings, bold)	Display	Info
	C17	Zero point (zero point / U _{is}) is displayed	Usual values Glass: pH 7.00 pH 5.00 to 9.00 Antimony: pH 1.00 pH -1.00 to 3.00 ISFET: current value -500 to +500 mV		For ISFET, the zero point is displayed in mV.
Press CAL.					
	C18	Calibration status is displayed	Display: o.k. or error code		
Press CAL.					
	C19	Store calibration result?	yes no New		If C18 = E xx, then only No or New. If New, return to C. If Yes/No, return to "Measurement".
The electrode can now be reinstalled in the process.					
C (2)		CALIBRATION function group: Calibration for ORP mV	Calibration ORP mV		Only for A1 = ORP (mV).
The measuring transmitter has a calibrated mV display range. An absolute mV value with a single buffer solution (adjustment of measuring chain offset) is set. Here, a buffer solution is used, preferably with 225 or 475 mV.					The maximum permitted calibration offset is ±100 mV.
	C21	Enter the mV value belonging to the ORP buffer used	Current measured value 1500 to 1500 mV		In the case of symmetrical measuring operation, the potential matching pin must also be immersed in the buffer.
	C22	Calibration is performed Display flashes	mV value		Stability check: The value is accepted in the event of stability ≤ ±1 mV for more than 10 s.
	C23	Zero point is displayed	-100 to 100 mV		
	C24	Calibration status is displayed	Display: o.k. or error code		
Press CAL.					

Coding		Field	Setting range (Factory settings, bold)	Display	Info
	C25	Store calibration result?	yes no new		If C24 = E xxx, then only No or New . If New, return to C. If Yes/No, return to "Measurement".
	C (3)	CALIBRATION function group: Calibration for ORP %	Calibration ORP %		Sensor adjustment with compensation for wall effects.
<p>For the calibration, a sample of the medium is placed in two containers. The contents of the first container is detoxified. The contents of the second container remains unchanged. A relative value of 80 % is set with the "toxic" sample. A relative value of 20 % is set with the "non-toxic" sample.</p>				<p>Default values: 0 % = -1000 mV 100 % = +1000 mV</p>	<p>The calibration range is ±1500 mV, the minimum difference should be 60 mV.</p>
	C31	Determine 80% value of the "toxic" sample	80% 0 to 100%		Start the calibration of the "toxic" sample by pressing the CAL key. The value is accepted provided it is stable or confirmed with the CAL key (see calibration pH).
	C32	Calibration is performed Display flashes	mV value is displayed		Accepted in the event of stability ≤ ±5 mV for more than 10 s.
	C33	Determine 20% value of the "non-toxic" sample	20% 0 to 100%		The procedure for C31 is repeated with the "non-toxic" sample to calibrate value 2.
	C34	Calibration is performed Display flashes	mV value is displayed		Stability check: The value is accepted in the event of stability ≤ ±5 mV for more than 10 s.
	C35	Calibration status is displayed	Display: o.k. or error code		
Press CAL.					
	C36	Store calibration result?	yes no new		If C35 = E xxx, then only No or New . If New, return to C. If Yes/No, return to "Measurement".
The electrode can now be reinstalled in the process.					

Numeric calibration

During numerical calibration, the slope and zero point can be corrected manually.

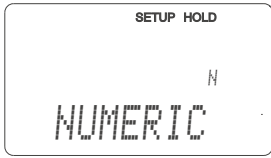
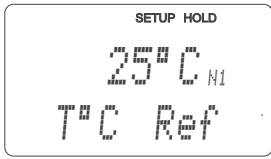
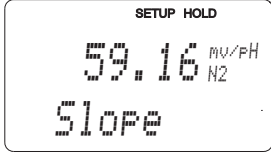
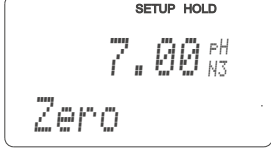
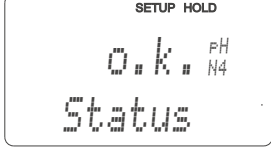
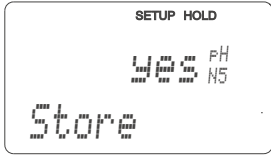
Coding	Field	Setting range (Factory settings, bold)	Display	Info
N	NUMERIC CALIBRATION function group			
N1	Enter reference temperature	25.0° C -50.0 to 150.0° C		
N2	Enter slope	Glass: 59.16 mV/pH 38.00 to 65.00 mV/pH Antimony: 59.16 mV/pH 25.00 to 65.00 mV/pH ISFET: 59.16 mV/pH 38.00 to 65.00 mV/pH		For A4 = ISFET: enter the slope from the quality certificate.
N3	Enter zero point	Glass: 7.00 pH 5.00 to 9.00 pH Antimony: 1.00 pH -1.00 to 3.00 pH ISFET: 0 mV -500 to +500 mV		For A4 = ISFET: enter the voltage U_{IS} from the quality certificate.
N4	Calibration status is displayed	Display: o.k. or error code		
Press CAL.				
N5	Store calibration result?	yes no new		

Offset

The settings in the OFFSET function group can be used to calibrate the measurement to a reference measurement. This requires a linear shift of all the measured values, i.e. the adjustment is determined for one measured value, and all others are calculated using the same adjustment.

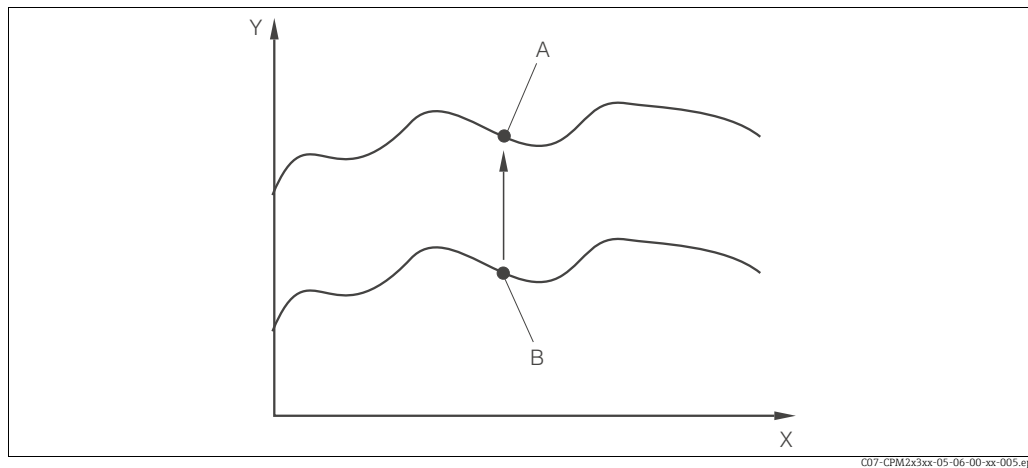

Fig. 45: Offset
 X Time
 Y Measured value
 A Calibrated value
 B Current measured value

i Following a calibration, the offset is automatically set to zero.

Coding	Field	Setting range (Factory settings, bold)	Display	Info
V	OFFSET function group for pH or ORP			Depending on the operating mode selected, either pH or ORP appears (i.e. no direct selection can be made)
V1	Enter desired measured value	Current measured value pH -2.00 to 16.00 -1500 to 1500 mV 0.0 to 100.0 %		You can edit the display. The entry can differ from the actual value by max. ±2.0 pH / ±120 mV / ±50 %.
V2	Current offset is displayed	pH 0.00 pH -2.00 to 2.00 0 mV -120 to 120 mV 0.0 % -50.0 to 50.0 %		
V3	Calibration status is displayed	Display: o.k. or error code		
Press CAL.				
V4	Store calibration result?	yes no new		If V3 = E xxx, then only No or New. If New, return to V. If Yes/No, return to "Measurement".

7 Diagnostics and troubleshooting

7.1 Troubleshooting instructions

The transmitter constantly monitors its functions itself. If an error occurs which the device recognizes, this is indicated on the display. The error number is shown below the display of the main measured value. If more than one error occurs, you can call these up with the MINUS key.

Refer to the "System error messages" table for the possible error numbers and remedial measures.

Should a malfunction occur without any transmitter error message, please refer to the "Process-specific errors" or the "Device-specific errors" tables to localize and rectify the error. These tables provide you with additional information on any spare parts required.

7.2 System error messages

You can display and select the error messages with the MINUS key.

Error no.	Display	Tests and/or remedial measures	Alarm contact		Error current		Autom. cleaning start		PROFIBUS Status	
			Facty	User	Facty	User	Facty	User	pH	Temp
E001	EEPROM memory error	1. Switch device off and then on again.	Yes		No		—	— ¹⁾	OC	OC
E002	Instrument not calibrated, calibration data invalid, no user data invalid (EEPROM error), instrument software not suitable to hardware (controller)	2. Load device software compatible with the hardware (with optoscope, see "Optoscope service tool" section). 3. Load measurement-parameter specific device software. 4. If the error persists, send in the device for repair to your local Endress+Hauser subsidiary or replace the device.	Yes		No		—	— ¹⁾	OC	OC
E003	Download error	Invalid configuration. Repeat download, check optoscope.	Yes		No		No		OC	OC
E004	Instrument software version not compatible with module hardware version	Load software compatible with hardware	Yes		No		No		OC	OC
E007	Transmitter malfunction, instrument software not compatible with transmitter version	Load measurement-parameter specific device software.	Yes		No		—	— ¹⁾	OC	OC
E008	SCS alarm: Glass electrode: glass breakage ISFET: leakage current > 400 nA	Check glass electrode for glass breakage or hair-line cracks; Inspect electrode plug-in head for moisture and dry if necessary; Check medium temperature. Replace ISFET.	Yes		No		No		OC	80
E010	Temperature sensor defective, not connected or short-circuited	Check temperature sensor and connections; check device and measuring cable with temperature simulator if necessary. Check correct option selected in field A5.	Yes		No		No		80	OC
E029	SCS reference electrode warning	Error detected during sensor self test. Check sensor. If necessary, replace it.	Yes		No		—		OC	OC
E030	SCS reference electrode warning	Check reference electrode for contamination and damage; clean electrode.	Yes		No		No		OC	80

Error no.	Display	Tests and/or remedial measures	Alarm contact		Error current		Autom. cleaning start		PROFIBUS Status	
			Facty	User	Facty	User	Facty	User	pH	Temp
E032	Slope range exceeded or below range	Repeat calibration and renew buffer solution; replace electrode if necessary, check device and measuring cable with simulator.	No		No		—	— ¹	80	80
E033	pH value zero too low or too high		No		No		—	— ¹	80	80
E034	ORP offset range exceeded or below range		No		No		—	— ¹	80	80
E041	Calculation of calibration parameters aborted	Repeat calibration and renew buffer solution; replace electrode if necessary, check device and measuring cable with simulator.	No		No		—	— ¹	80	80
E042	Distance of calibration value for buffer pH 2 from zero (pH 7) too short	Use buffer solution that is at least Δ pH = 2 from electrode zero point.	No		No		—	— ¹	80	80
E043	Distance between calibration values for pH 1 and pH 2 too short	Use buffer solutions that are at least Δ pH = 2 apart.	No		No		—	— ¹	80	80
E044	Stability requirement for calibration not fulfilled	Repeat calibration and renew buffer solution; replace electrode if necessary, check device and measuring cable with simulator.	No		No		—	— ¹	80	80
E045	Calibration aborted	Repeat calibration and renew buffer solution; replace electrode if necessary, check device and measuring cable with simulator.	No		No		—	— ¹	80	80
E046	Parameter limits of current output 1 mixed up	Correct your settings	Yes		No		—	— ¹	80	80
E047	Parameter limits of current output 2 mixed up		Yes		No		—	— ¹	80	80
E055	SCS reference electrode warning	Check electrode for contamination and damage; clean electrode; measuring can continue until the error occurs.	Yes		No		No		44	80
E057	Main parameter measuring range exceeded		Yes		No		No		44	80
E059	Below temperature measuring range		Yes		No		No		80	44
E061	Temperature measuring range exceeded		Yes		No		No		80	44
E063	Below current output range 1	Check configuration in the "Current outputs" menu; check measurement and connections; check device and measuring cable with simulator if necessary.	Yes		No		No		80	80
E064	Current output range 1 exceeded		Yes		No		No		80	80
E065	Below current output range 2		Yes		No		No		80	80
E066	Current output range 2 exceeded		Yes		No		No		80	80
E067	Set point exceeded controller 1	Check configuration.	Yes		No		No		80	80
E068	Set point exceeded controller 2		Yes		No		No		80	80
E069	Set point exceeded controller 3		Yes		No		No		80	80
E070	Set point exceeded controller 4		Yes		No		No		80	80

Error no.	Display	Tests and/or remedial measures	Alarm contact		Error current		Autom. cleaning start		PROFIBUS Status	
			Facty	User	Facty	User	Facty	User	pH	Temp
E080	Current output 1 range too small	Increase range in "Current outputs" menu.	Yes		No		—	— ¹	80	80
E081	Current output 2 range too small		Yes		No		—	— ¹	80	80
E085	Incorrect setting for error current	If the current range "0 to 20 mA" was selected in field O311, the error current "2.4 mA" may not be set.	Yes		No		No		80	80
E094	Incompatible sensor version	Digital sensor and transmitter are not compatible. Possibly, Ex version of sensor is used with non-Ex version of transmitter or vice versa.	Yes		No		No		0C	0C
E100	Current simulation active		No		No		—	— ¹	80	80
E101	Service function active	Switch off service function or switch device off and then on again.	No		No		—	— ¹	80	80
E102	Manual mode active		No		No		—	— ¹	80	80
E106	Download active	Wait for download to finish.	No		No		—	— ¹	80	80
E116	Download error	Repeat download.	Yes		No		—	— ¹	0C	0C
E127	Memosens powerfail; sensor communication present but sensor has too little current	Check whether the Memosens connection is correctly inserted and locked.	Yes		No		No		0C	0C
E147	Sensor communication faulty	Check that the sensor is correctly connected, the cable ends are correctly wired at the terminals and the cable is not damaged.	Yes		No		No		0C	0C
E152	PCS alarm	Check sensor and connection.	Yes		No		No		44	44
E153	Calibration offset out of limits	1. Repeat calibration. 2. Check calibration solutions. 3. Replace sensor.	No		No		No		80	80
E154	Below lower alarm threshold for period exceeding alarm delay	Perform manual comparison measurement if necessary. Service sensor and recalibrate.	Yes		No		No		— ²⁾	-
E155	Above upper alarm threshold for period exceeding alarm delay		Yes		No		No		-	-
E156	Actual value undershoots alarm threshold for longer than the set permissible maximum period		Yes		No		No		-	-
E157	Actual value exceeds alarm threshold for longer than the set permissible maximum period		Yes		No		No		-	-
E162	Dosage stop	Check settings in the CURRENT INPUT and CHECK function groups.	Yes		No		No		-	-
E164	Dynamic range of pH converter exceeded	Check cable and sensor.	Yes		No		—		-	-
E166	Dynamic range of reference converter exceeded	Check cable and sensor.	Yes		No		—		-	-
E168	Warning: ISFET leakage current > 200 nA	Check ISFET for abrasion and airtightness, replace as soon as possible.	No		No		No		-	-
E171	Flow in main stream too low or zero	Restore flow.	Yes		No		No		-	-

Error no.	Display	Tests and/or remedial measures	Alarm contact		Error current		Autom. cleaning start		PROFIBUS Status	
			Facty	User	Facty	User	Facty	User	pH	Temp
E172	Switch-off limit for current input exceeded	Check process variables at sending measuring instrument. Change range assignment if necessary.	Yes		No		No		-	-
E173	Current input < 4 mA	Check process variables at sending measuring instrument.	Yes		No		No		-	-
E174	Current input > 20 mA	Check process variables at sending measuring instrument. Change range assignment if necessary.	Yes		No		No		-	-
E175	SCS glass warning	Check electrode for glass breakage or hair-line cracks; Check medium temperature. Measurement can continue until the error occurs.	No		No		No		44	80
E177	SCS reference electrode warning	Check electrode for contamination and damage; clean electrode; measuring can continue until the error occurs.	No		No		No		44	80
E180	Data error sensor	No measured value from the digital sensor. Check that the sensor is correctly connected.	Yes		No		No		0C	0C

- 1) If this error occurs, there is no possibility of starting a cleaning session (field F8 not applicable with this error).
- 2) Current error messages not applicable via PROFIBUS

7.3 Process specific errors

Use the following table to localize and rectify any errors occurring.

Errors	Possible cause	Tests and/or remedial measures	Tools, spare parts
Device cannot be operated, display value 9999	Operation locked	Press CAL and MINUS keys simultaneously	See "Function of keys" section.
Measuring chain zero-point cannot be adjusted	Reference system toxified	Test with new sensor	pH/ORP sensor
	Diaphragm clogged	Clean or grind down diaphragm	HCl 3 %, use file (only file in one direction)
	Measuring line open	Short-circuit pH input on instrument ⇒ display pH 7	
	Sensor asymmetry voltage too high	Clean diaphragm or test with another sensor	HCl 3 %, use file (only file in one direction); sensor
	Potential matching (PA/PM) transmitter ⇔ wrong medium	Asymm.: no PM or PM at PE Symm.: PM connection mandatory	See "Electrode installation and measuring cable connection" section
No or creeping change of display	Sensor contaminated	Clean sensor.	See "Cleaning pH/ORP electrodes" section.
	Sensor ageing	Replace sensor.	New sensor
	Sensor defective (reference lead)	Replace sensor.	New sensor
	No internal buffer	Check KCl supply (0.8 bar (11.6 psi) above medium pressure).	KCl (CPY 4-x)
Measuring chain slope not adjustable/slope too small	No high-impedance connection (moisture, dirt)	Check cable, plug connector and junction boxes.	pH simulator, insulation, see "Checking the connecting lines and boxes" section
	Device input defective	Check device directly.	pH simulator
	Sensor ageing	Renew sensor.	pH sensor
Measuring chain slope not adjustable/no slope	Hair-line crack in the glass membrane	Renew sensor.	pH sensor
	No high-impedance connection (moisture, dirt)	Check cable, plug connector and junction boxes.	pH simulator, insulation, see "Checking the connecting lines and boxes" section
Permanent, incorrect measured value	Sensor not immersing or protection cap not removed	Check installation position, remove protection cap.	
	Air cushion in assembly	Check assembly and orientation.	
	Ground connection at or in device	Perform test measurement in insulated vessel, poss. with buffer solution.	Plastic vessel, buffer solutions
	Hair-line crack in the glass membrane	Renew sensor.	pH sensor
	Impermissible device operating status (no reaction to key actuation)	Switch device off and then on again.	EMC problem: if this persists, check the grounding, screens and line routing or have checked by Endress+Hauser Service.
Incorrect temperature value	Incorrect sensor connection	Check connections using wiring diagram.	Wiring diagram "Electrical connection" section
	Measuring cable defective	Check cables for interruptions/short-circuit/shunt.	Ohmmeter
	Incorrect sensor type	Set type of temperature sensor at the device (field B1).	Glass electrode: Pt 100 ISFET: Pt 1000

Errors	Possible cause	Tests and/or remedial measures	Tools, spare parts
pH value in process wrong	No/incorrect temperature compensation	ATC: activate function. MTC: adjust process temperature.	
	Conductivity of medium too low	Select pH sensor with liquid KCl.	e.g. Ceraliquid CPS41
	Flow too high	Reduce flow or measure in a bypass.	
	Potential in medium	Poss. ground with or at PM pin (connection PM/PE).	Problem occurs particularly in plastic lines.
	Sensor contaminated or assigned	Clean sensor (see "Cleaning pH/ORP sensors" section).	For heavily contaminated media: Use spray cleaning.
Measured value fluctuations	Interference on measuring cable	Connect cable as per wiring diagram.	See "Electrical connection" section.
	Interference on signal output line	Check line routing, lay line separately if necessary.	Signal output and measuring input lines
	Interference potential in medium	Measure symmetrically (with PML).	Poss. ground medium with PM/PE connection.
	No potential matching (PA/PM) for symmetrical input	Connect PM pin in assembly with devices PA/PM.	
Controller/limit contact does not work	Controller switched off	Activate controller.	See "Relay contact configuration" section or fields R2xx.
	Controller in operating mode "Manual/off"	Select "Auto" or "Manual on" mode.	Keyboard, REL key
	Pick-up delay set too long	Switch off or shorten pick-up delay time.	See fields R2xx.
	"Hold" function active	"Auto hold" for calibration, "Hold" input activated, "Hold" active via keyboard.	See fields S2 to S4.
Controller/limit contact works constantly	Controller in operating mode "Manual/on"	Set controller to "Manual/off" or "Auto".	Keyboard, REL and AUTO keys
	Drop-out delay set too long	Reduce drop-out delay time.	See fields R2xx.
	Control circuit interrupted	Check measured value, current output or relay contacts, adjusters, chemical supply.	
No pH/mV current output signal	Line open or short-circuited	Disconnect line and measure directly at the device.	mA meter 0–20 mA DC
	Output defective	See "Diagnosis" section.	
Fixed pH/mV current output signal	Current simulation active	Switch off simulation.	See field O2.
	Impermissible processor system operating status	Switch device off and then on again.	EMC problem: if it persists, check the installation.
Incorrect current output signal	Incorrect current assignment	Check current assignment: 0–20 mA or 4–20 mA?	Field O211
	Overall burden in the current loop too high (> 500 Ω)	Disconnect output and measure directly at the device.	mA meter for 0–20 mA DC
Current output table is not accepted	Value distance too small	Select practical distances.	
No temperature output signal	Device does not have a second current output	Check version using nameplate, if necessary, replace module LSCH-x1.	Module LSCH-x2, See "Spare parts" section.
	Device with PROFIBUS-PA	PA device does not have any current output!	
Chemoclean function not available	No relay module (LSR1-x) installed or only LSR1-2 available	Install LSR1-4 module. The Chemoclean is enabled using the release code supplied by E+H in the Chemoclean retrofit kit.	Module LSR1-4, see "Spare parts" section.

Errors	Possible cause	Tests and/or remedial measures	Tools, spare parts
No functions from Plus Package available	Plus Package not enabled (enable by entering a code which depends on the serial number and which is supplied by E+H when a Plus Package is ordered)	<ul style="list-style-type: none"> - For Plus Package retrofit: enter code supplied by E+H. - Following replacement of a defective module LSCH/LSCP: first enter device serial number (see nameplate) by hand, then enter existing code number. 	For a detailed description, see "Replacing central module" section.
No HART or PROFIBUS communication	Several devices at the same address	Check addresses and re-enter if necessary.	No communication possible for several devices of the same address.
No HART communication	No HART central module	Check using nameplate: HART = -xxx5xx and -xxx6xx	Retrofit to LSCH-H1 / -H2.
	Current output < 4 mA	For further information, see BA00208C/07/EN, "HART field communication with Liquisys M CxM223/253".	
	No or incorrect DD (device description)		
	HART interface missing		
	Device not registered in HART server		
	Load too small (must be > 230 Ω)		
	HART receiver (e.g. B. FXA195) not connected via load but via power supply		
	Incorrect device address (addr. = 0 for single operation, addr. > 0 for multidrop operation)		
	Line capacitance too high		
Interference on line			
No PROFIBUS communication	No PA/DP central module	Check using nameplate: PA = -xxx3xx /DP = xxx4xx	Retrofit to LSCP module, see "Spare parts" section.
	Incorrect device software version (without PROFIBUS)	Address setting up to 126 in field I1 possible?	
	Incorrect terminals for PROFIBUS DP	Connection of PROFIBUS DP via the relay assembly, see connection scheme	
	No or incorrect DD/DTM	For further information, see BA00209C/07/EN, "PROFIBUS-PA/DP - field communication with Liquisys M CxM223/253".	
	Baudrate for segment coupler incorrectly set in DPV-1 server		
	Bus user (master) has wrong address or address assigned twice		
	Bus user (slave) has wrong address		
	Bus line not terminated		
	Line problems (too long, cross-section too small, not screened, screen not grounded, cores not twisted, not specified PA or DP cable, distance to supply lines too short, spurs too long)		
Bus voltage too low (Bus voltage typ. 24 V DC for non-Ex)	The voltage at the device PA/DP connection must be at least 9 V.		

7.4 Instrument specific errors

The following table helps you during the diagnosis and points to any spare parts required.

Depending on the degree of difficulty and the measuring equipment present, diagnosis is carried out by:

- Trained operator personnel
- The user's trained electrical technicians
- Company responsible for system installation/operation
- Endress+Hauser Service

Information on the exact spare part designations and on how to install these parts can be found in the "Spare parts" section.

Error	Possible cause	Tests and/or remedial measures	Execution, tools, spare parts
Display dark, no light-emitting diode active	No line voltage	Check whether line voltage is present.	Electrical technician/e.g. multimeter
	Supply voltage wrong/too low	Compare actual line voltage and nameplate data.	User (data for energy supply company or multimeter)
	Connection faulty	Terminal not tightened; Insulation jammed; Wrong terminals used.	Electrical technician
	Device fuse defective	Compare line voltage and the nameplate data and replace fuse.	Electrical technician/suitable fuse; see drawing in "Spare parts" section.
	Power unit defective	Replace power unit, note variant.	On-site diagnosis by Endress+Hauser Service, test module necessary
	Central module defective	Replace central module, note variant.	On-site diagnosis by Endress+Hauser Service, test module necessary
	CPM253: ribbon cable item 310 loose or defective	Check ribbon cable, renew if necessary.	See "Spare parts" section.
Display dark, light-emitting diode active	Central module defective (module: LSCH/LSCP)	Renew central module, note variant.	On-site diagnosis by Endress+Hauser Service, test module necessary
Display is on but – No change in display and/or – Device cannot be operated	Device or module in device not correctly mounted	CPM223: reinstall insert. CPM253: remount display module.	Perform with the aid of the installation drawings in the "Spare parts" section.
	Operating system in unpermitted mode	Switch device off and then on again.	Poss. EMC problem: if this persists, check the installation or have checked by Endress+Hauser Service.
Device gets hot	Voltage wrong/too high	Compare line voltage and nameplate data.	User, electrical technician
	Power unit defective	Replace power unit.	Diagnosis only by Endress+Hauser Service
Measured value pH/mV and/or temperature measured value incorrect	Transmitter module defective (module: MKIC), please first carry out tests and take measures as per the "Process errors without messages" section.	Measuring input test: – Connect pH, ref and PM directly at the device with wire jumpers = display pH 7 – Resistance 100 Ω at terminals 11 / 12 + 13 = display 0 °C	If test negative: replace module (note variant). Perform with the aid of the exploded drawings in the "Spare parts" section.
Current output, current value incorrect	Adjustment not correct	Check with installed current simulation, connect mA metre directly to current output.	If simulation value incorrect: adjustment in factory or new module LSCH required. If simulation value correct: check current loop for load and shunts.
	Load too big		
	Shunt/short to ground in current loop		
	Incorrect mode of operation	Check whether 0–20 mA or 4–20 mA is selected.	
No current output signal	Current output stage defective (module LSCH)	Check with installed current simulation, connect mA metre directly to current output.	If test negative: Renew central module LSCH (note variant).
No function of additional relay	CPM253: ribbon cable item 320 loose or defective	Check ribbon cable seating, renew cable if required.	See "Spare parts" section.

Error	Possible cause	Tests and/or remedial measures	Execution, tools, spare parts
Only 2 additional relays can be triggered	Relay module LSR1-2 installed with 2 relays	Upgrade to LSR1-4 with 4 relays.	User or Endress+Hauser Service
Additional functions (S-package) missing	No or incorrect release code used	If retrofitting; check whether the correct serial number was quoted when ordering the S-package.	Handled by Endress+Hauser Sales
	Incorrect device serial number saved in LSCH/LSCP module	Check whether serial number on the nameplate matches SNR in LSCH/ LSCP (field S 8).	The serial number of the device is definitive for the S-package.
Additional functions (S-package and/or Chemoclean) missing after LSCH/LSCP module replaced	Replacement modules LSCH or LSCP have the device serial number 0000 when they leave the factory. The S-package or Chemoclean are not enabled on leaving the factory.	In the case of LSCH/LSCP with SNR 0000, a device serial number can be entered once in fields E114 to E116. Then enter the release code for the S-package and/or Chemoclean.	For a detailed description, see "Replacing central module" section.
No HART or PROFIBUS-PA/-DP interface function	Incorrect central module	HART: LSCH-H1 or H2 module, PROFIBUS-PA: LSCP-PA module, PROFIBUS-DP: LSCP-DP module, see field E112.	Replace central module; User or Endress+Hauser Service
	Wrong software	SW version see field E111.	SW can be modified with optoscope.
	Bus problem	Remove some devices and repeat the test.	Contact Endress+Hauser Service.

8 Maintenance

Take all the necessary measures in time to guarantee the operational safety and reliability of the entire measuring system.

Maintenance work at the transmitter comprises:

- Calibration (see "Calibration" section)
- Cleaning of assembly and sensor
- Cable and connection check

When performing any work on the device, bear in mind any potential impact this may have on the process control system or on the process itself.

NOTICE

Electrostatic discharge (ESD)

Risk of damage to electronic components

- ▶ Take personal protective measures to avoid ESD, such as discharging beforehand at PE or permanent grounding with a wrist strap.
- ▶ For your own safety, use only genuine spare parts. With genuine spare parts, the function, accuracy and reliability are also guaranteed after repair.

8.1 Maintenance of the entire measuring point

8.1.1 Cleaning the transmitter

Clean the front of the housing with usual commercial cleaning agents.

In accordance with DIN 42 115, the front is resistant to:

- Ethanol (short periods)
- Diluted acids (max. 2% HCl)
- Diluted bases (max. 3% NaOH)
- Soap-based household cleaners

NOTICE

Prohibited cleaning agents

Damage to the housing surface or housing seal

- ▶ For cleaning purposes, never use concentrated mineral acids or bases.
- ▶ Never use organic cleaners such as benzyl alcohol, methanol, methylene chloride, xylene or concentrated glycerol cleaner.
- ▶ Never use high-pressure steam for cleaning purposes.

8.1.2 Cleaning the pH/ORP sensors

▲ CAUTION

The cleaning system is not switched off during calibration or maintenance activities

Risk of injury due to medium or cleaning agent

- ▶ If a cleaning system is connected, switch it off before removing a sensor from the medium.
- ▶ If you are not switching off the cleaning system because you wish to test the cleaning function, wear protective clothing, goggles and gloves or take other appropriate measures.

Please clean **contamination on the glass electrodes** as follows:

- Oily and greasy films:
Clean with detergent (grease solvers, such as alcohol, acetone, poss. washing-up liquids).

▲ CAUTION

Risk of injury caused by cleaning agents

- ▶ When using the following cleaning agents, make sure to protect your hands, eyes and clothing!
 - Lime and metal hydroxide layers:
Dissolve layers with diluted hydrochloric acid (3 %) and then rinse carefully with a lot of clear water.
 - Layers containing sulphide (from flue gas desulphurizing or sewage treatment plants):
Use mixture of hydrochloric acid (3 %) and thiocarbamide (usual commercial) and then rinse carefully with a lot of clear water.
 - Layers containing proteins (e.g. food industry):
Use mixture of hydrochloric acid (0.5 %) and pepsin (usual commercial) and then rinse carefully with a lot of clear water.

ORP sensors:

Carefully clean the metal pins or surfaces mechanically.

- After mechanical cleaning, the ORP sensor can require several hours conditioning time. For this reason, check the calibration after a day.

ISFET sensors

- When cleaning ISFET sensors, do not use any acetone as this can damage the material.
- After cleaning with compressed air, ISFET sensors need approx. 5 to 8 minutes until the closed-control loop is reestablished and the measured value is adjusted to the real value.

Clogged diaphragms can be cleaned mechanically (does not apply to Teflon diaphragms and open ring junction electrodes):

- Use a small warding file.
- Only file in one direction.

Air bubbles in the electrode:

- Air bubbles can indicate incorrect mounting. For this reason check the orientation.
- The range 15 to 165 to the horizontal is allowed.
- Not permitted: horizontal installation or installation with the plug-in head pointing downwards.

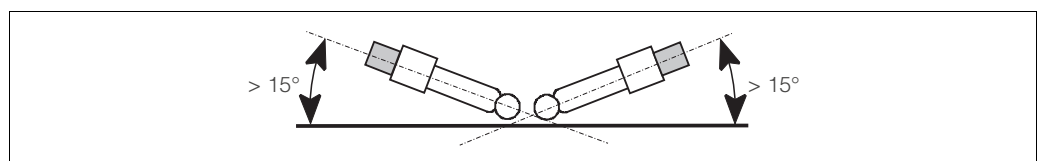

Fig. 46: Permitted angle of installation for glass electrodes

C07-CPM2x3xx-05-06-00-xx-006.eps

Reduced reference system

The inner metal lead of the reference system (Ag/AgCl) of a combination electrode or a separate reference electrode is usually light-brown and matt. A silver-colored reference system is reduced and therefore defective. The cause is a current flowing through the reference element. Possible causes:

- Incorrect operating mode selected for the measuring device (PM pin connected but unsymmetrical operating mode selected ("no PM"). See the function description on "Selecting the type of connection".
- Shunt in measuring cable (e.g. due to humidity) between reference line and grounded screen or PM line.
- Measuring instrument defective (shunt in reference input or entire input amplifier downstream of PE).

8.1.3 Maintaining digital sensors

Proceed as follows to maintain the digital sensors with Memosens functionality:

1. If an error occurs or the sensor has to be replaced according to the maintenance schedule, take a new or precalibrated sensor from the lab.
In the lab, a sensor is calibrated under optimum external conditions to ensure a higher quality of measurement.
2. Remove the contaminated sensor and insert the new sensor.
3. A calibration is necessary if you are using a sensor which was not pre-calibrated.
4. The sensor data are automatically taken by the transmitter. No release code is required.
5. Measurement is continued.
6. Take the used sensor back to the lab. Here you can possibly make the sensor ready for use again without the measuring point having to suffer downtime.
 - Clean the sensor. For this purpose, use the cleaning agent indicated for the sensor.
 - Inspect the sensor for cracks or other damage.
 - Regenerate the sensor if it is not damaged. Store it for 24 hours in a 3M KCl solution.
 - Recalibrate the sensor for the next use.

8.1.4 Liquid KCl supply

- The KCl must be free of bubbles. In the case of an unpressurized version, check whether the cotton thread is present in the hose.
- In the case of counterpressure, check whether the pressure in the KCl tank is min. 0.8 bar (11.6 psi) above the medium pressure.
- The KCl consumption should be low but noticeable. Approx. 1 to 10 ml/day is typical.
- The opening for sensors with a KCl top-up opening at the glass shaft must be clear.

8.1.5 Assembly

Please refer to the corresponding assembly Operating Instructions for information on maintaining and trouble-shooting the assembly. Here you can find a description for assembling and disassembling, sensor replacement, seal replacement, as well as information on stability and spare parts and accessories.

8.1.6 Connecting lines and junction boxes

Check the cables and connections for moisture. Moisture is indicated by a sensor slope that is too small. If no more display is possible or if the display is fixed at pH 7, please check the following components:

- Sensor head
- Sensor connector
- pH measuring cable
- Junction box, if fitted
- Extension cable

NOTICE

Faulty measurement due to moisture in the measuring cable

- ▶ If there is moisture in the measuring cable, the cable must be replaced!

A shunt in the cable of $> 20 \text{ M}\Omega$ can no longer be measured with normal multimeters but is damaging for the pH measurement. A reliable test can be carried out with a usual commercial insulation meter:

- Make sure to disconnect the pH measuring cable from the sensor and device!
- If you are using a junction box, check the infeed and outfeed measuring cable separately.
- Check the cable with 1000 V DC (at least with 500 V DC) testing voltage.
- If the cable is intact, the insulation resistance $> 100 \text{ G}\Omega$.
- If the cable is defective (moist), there is flashover.
The cable must be replaced.

-  The sensor head and junction box can be cleaned and dried with a hot air dryer.

9 Repair

9.1 Spare parts

Spare parts are to be ordered from your sales center responsible. Specify the order numbers listed in the chapter "Spare parts kits".

To be on the safe side, you should **always** specify the following data with your spare part orders:

- Instrument order code (order code)
- Serial number (serial no.)
- Software version where available

Refer to the nameplate for the order code and serial number.

The software version is displayed in the instrument software (see chapter "Instrument configuration") if the instrument processor system is functional.

9.2 Dismantling the panel-mounted instrument

 Please note the effects on the process if the device is taken out of service!

Please refer to the following diagram for the item numbers.

1. Disconnect the terminal block (item 422 b) from the rear of the device to de-energize the device.
2. Then remove the terminal blocks (item 422 a and poss. 430) from the rear of the device. Now you can disassemble the device.
3. Press in the latches of the end frame (item 340) and remove the frame from the rear.
4. Release the special screw (item 400) by turning it counter-clockwise.
5. Remove the entire electronics block from the housing. The modules are only mechanically connected and can be easily separated:
 - Simply remove the processor/display module from the front.
 - Pull out the brackets of the rear plate (item 320) slightly.
 - Now you can remove the side modules.
6. Remove the pH/mV transmitter (item 230) as follows:
 - Bend the screening plate up.
 - Disconnect the connected strand (pH input, strand comes from the BNC connection jack).
 - Using a fine side-cutting pliers, nip off the heads of the synthetic distance holders.
 - Then remove the module from above.

Assembly is the reverse of the disassembly sequence. Tighten the special screw hand-tight without a tool.

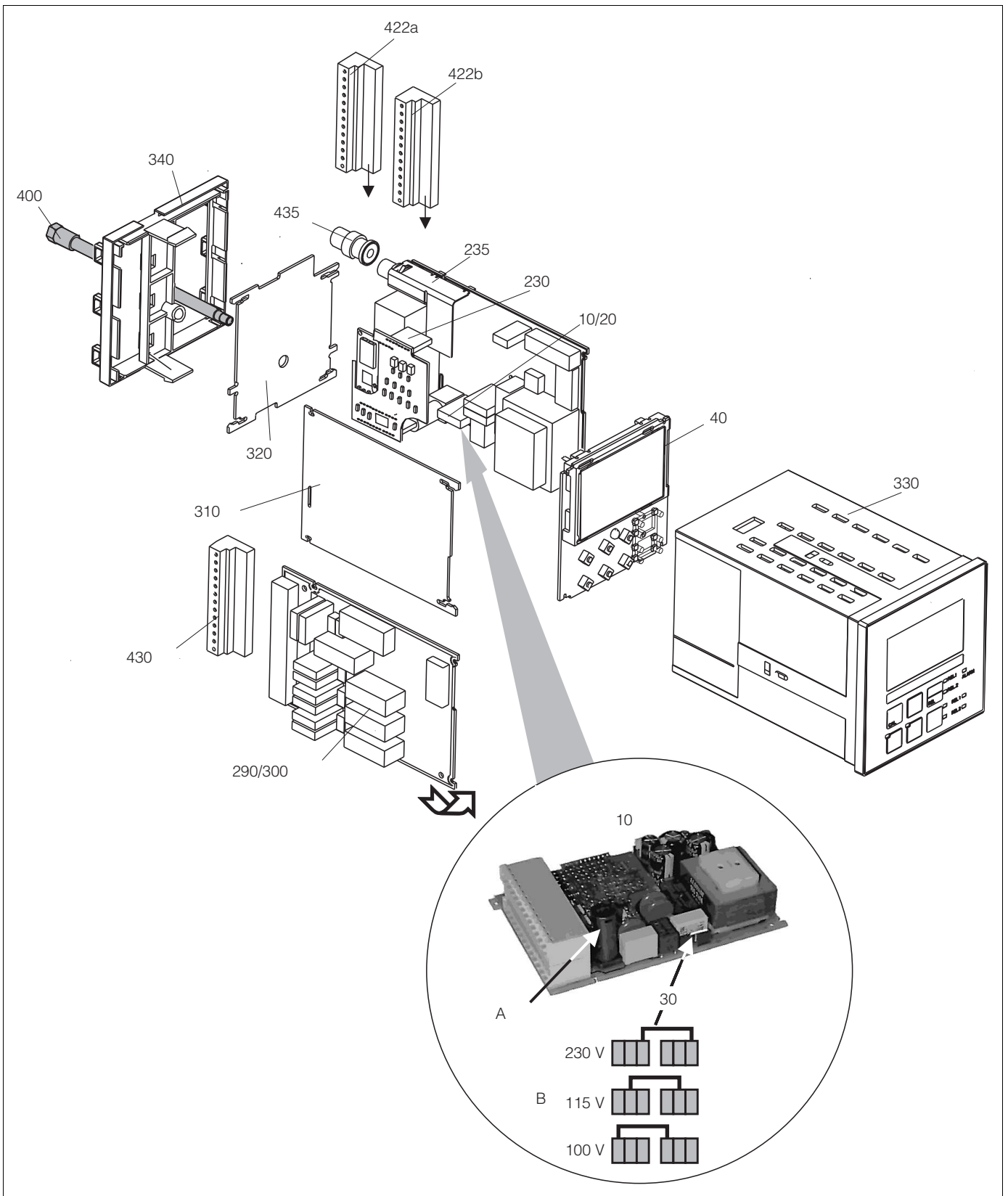

C07-CxM223xx-09-06-06-xx-001.eps

Fig. 47: Exploded drawing of panel-mounted instrument

The exploded drawing contains the components and spare parts of the panel-mounted instrument. You can take the spare parts and the corresponding order number from the following section using the item numbers.

Item	Kit description	Name	Function/contents	Order number
10	Power unit	LSGA	100 / 115 / 230 V AC	51500317
20	Power unit	LSGD	24 V AC + DC	51500318
30	Jumper		Part of power unit, item 10	
40	Central module	LSCH-S1	1 current output	51501081
40	Central module	LSCH-S2	2 current outputs	51501082
40	Central module	LSCH-H1	1 current output + HART	51501083
40	Central module	LSCH-H2	2 current outputs + HART	51501084
40	Central module	LSCP	PROFIBUS PA/no current output	51501085
40	Central module	LSCP	PROFIBUS DP/no current output	51502503
40	Kit CPM2x3 Central module PROFIBUS DP	LSCP-DP	Central module PROFIBUS DP Relay module + 2 relays Current input and terminals valid of: hardware version 2.10	71134724
230	pH/mV transmitter	MKP1	pH/mV + temperature input Glass electrode	51501080
230	pH/mV transmitter	MKP2	pH/mV + temperature input ISFET sensor	51507096
230	pH/mV transmitter	MKP3	pH/mV + temperature input Glass electrode software versions 2.55 HART, 2.33 PROFIBUS or newer	51518244
230	Memosens-transmitter	MKD1	digital input	51514966
235	pH/mV input		BNC connection jack + screening plate	51501070
290	Relay module	LSR1-2	2 relays	51500320
290	Relay module	LSR2-2i	2 relays + current input 4 to 20 mA	51504304
290	Kit CxM2x3 Relay module PROFIBUS DP	LSR2-DP	Relay module + 2 relays Current input and terminals DP valid of: hardware version 2.10	71134732
300	Relay module	LSR1-4	4 relays	51500321
300	Relay module	LSR2-4i	4 relays + current input 4 to 20 mA	51504305
310	Side panel		Kit with 10 parts	51502124
310, 320, 340, 400	Housing mechanical parts		Rear plate, side panel, end frame, special screw	51501076
330, 400	Housing module		Housing with front membrane, sensory tappets, gasket, special screw, tensioning dogs, connection plates and nameplates	51501075
340	End frame		Rear frame for PROFIBUS DP, with D- submin plug connector	51502513
zu 340	PE terminal		PE terminal for screen grounding for IS version	51501086
422a, 422b	Terminal strip set		Complete terminal strip set, standard + HART	51501077
422a, 422b	Terminal strip set		Complete terminal strip set, PROFIBUS PA	51501077
422a, 422b	Terminal strip set		Complete terminal strip set, PROFIBUS DP	51502494
430	Terminal strip		Terminal strip for relay module	51501078
435	BNC connector, elbowed		pH/mV connection	50074961

Item	Kit description	Name	Function/contents	Order number
A	Fuse		Part of power unit, item 10	
B	Choice of line voltage		Position of jumper item 30 on power unit, item 10 depending on line voltage	

9.3 Dismantling the field instrument

 Please note the effects on the process if the device is taken out of service!

Please refer to the diagram for the item numbers.

1. Open and remove the cover of the connection compartment (item 420).
2. Disconnect the mains terminal (item 470) to de-energise the device.
3. Open the display cover (item 410) and loosen the ribbon cables (item 310 / 320) on the side of the electronics box (item 330).
4. To remove the central module (item 40), loosen the screw in the display cover (item 450 b).
5. Proceed as follows to remove the electronics box (item 330):
 - Release the screws in the housing base (item 450 a) in two revolutions.
 - Then push the entire box backwards and remove it from above.
 - Make sure that module locks do not open!
 - Bend the module locks out and remove the modules.
6. To remove the docking module (item 340), remove the screws in the housing base (item 450 c) and remove the entire module from above.
7. Proceed as follows to remove the pH/mV transmitter (item 230):
 - Bend the screening plate up.
 - Disconnect the connected strand (pH input, strand comes from the BNC connection jack).
 - Using a fine side-cutting pliers, nip off the heads of the synthetic distance sleeves.
 - Then remove the module from above.

To assemble, carefully push the modules into the trolley tracks of the electronics box and let them engage in the side box noses.

 Incorrect mounting is not possible. Modules inserted in the electronics box incorrectly are not operable since the ribbon cables cannot be connected.
Make sure the cover seals are intact to guarantee IP 65 ingress protection.

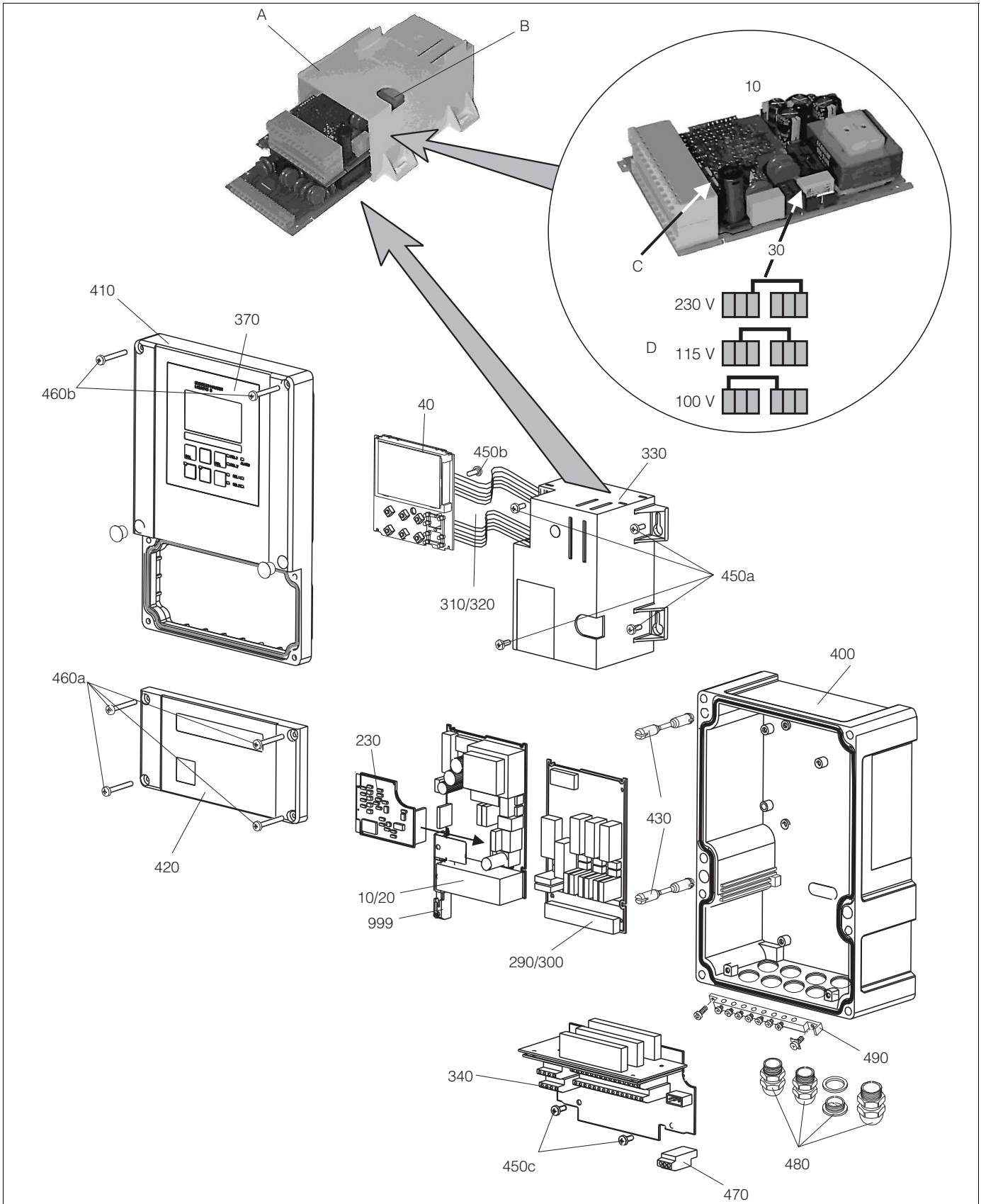

Fig. 48: Field device exploded drawing

C07-CxM253xx-09-06-06-xx-001.eps

The exploded drawing contains the components and spare parts of the field device. You can take the spare parts and the corresponding order number from the following section.

Item	Kit description	Name	Function/contents	Order number
10	Power unit	LSGA	100 / 115 / 230 V AC	51500317
20	Power unit	LSGD	24 V AC + DC	51500318
30	Jumper		Part of power unit, item 10	
40	Central module	LSCH-S1	1 current output	51501081
40	Central module	LSCH-S2	2 current outputs	51501082
40	Central module	LSCH-H1	1 current output + HART	51501083
40	Central module	LSCH-H2	2 current outputs + HART	51501084
40	Central module	LSCP	PROFIBUS PA/no current output	51501085
40	Central module	LSCP	PROFIBUS DP/no current output	51502503
40	Kit CPM2x3 Central module PROFIBUS DP	LSCP-DP	Central module PROFIBUS DP Relay module + 2 relays Current input and terminals valid of: hardware version 2.10	71134724
230	pH/mV transmitter	MKP1	pH/mV + temperature input Glass electrode	51501080
230	pH/mV transmitter	MKP2	pH/mV + temperature input ISFET sensor	51507096
230	pH/mV transmitter	MKP3	pH/mV + temperature input Glass electrode software versions 2.55 HART, 2.33 PROFIBUS or newer	51518244
230	Memosens-transmitter	MKD1	digital input	51514966
290	Relay module	LSR1-2	2 relays	51500320
290	Relay module	LSR2-2i	2 relays + current input 4 to 20 mA	51504304
290	Kit CxM2x3 Relay module PROFIBUS DP	LSR2-DP	Relay module + 2 relays Current input and terminals DP valid of: hardware version 2.10	71134732
300	Relay module	LSR1-4	4 relays	51500321
300	Relay module	LSR2-4i	4 relays + current input 4 to 20 mA	51504305
310, 320	Ribbon cable lines		2 ribbon cable lines	51501074
340, 330, 450	Inner housing fittings		Docking module, empty electronics box, small parts	51501073
450a, 450c	Torx screws K4x10		Part of inner housing fittings	
450b	Torx screw for central module		Part of inner housing fittings	
410, 420, 370, 430, 460	Housing cover		Display cover, connection compartment cover, front membrane, hinges, cover screws	51501068
460a, 460b	Cover screws		Part of housing cover	
430	Hinges		2 pairs of hinges	51501069
400, 480	Housing base		Base, threaded joints	51501072
470	Terminal strip		Terminal strip for connection to mains	51501079
490	PE rail		PE connection rail for screen grounding for IS version	51501087
999	pH/mV terminal module		ph/mV terminal + screening plate	51501071
A	Electronics box with relay module LSR1-x (bottom) and power unit LSGA/LSGD (top)			

Item	Kit description	Name	Function/contents	Order number
B	Fuse also accessible if electronics box installed			
C	Fuse		Part of power unit, item 10	
D	Choice of line voltage		Position of jumper item 30 on power unit, item 10 depending on desired line voltage	

9.4 Replacing the central module

 Generally, when a central module has been replaced, all data which can be changed are set to the factory setting.

Proceed as described below if a central module is replaced:

1. If possible, note the customized settings of the device, such as:
 - Calibration data
 - Current assignment, main parameter and temperature
 - Relay function selections
 - Limit value/controller settings
 - Cleaning settings
 - Monitoring functions
 - Interface parameters
2. Disassemble the device as explained in the "Dismantling the panel-mounted instrument" or "Dismantling the field instrument" section.
3. Use the part number on the central module to check whether the new module has the same part number as the previous module.
4. Assemble the device with the new module.
5. Start up the device again and check the basic functions (e.g. measured value and temperature display, operation via keyboard).
6. Enter the serial number:
 - Read the serial number ("ser-no.") on the nameplate of the device.
 - Enter this number in the fields E115 (year, one-digit), E116 (month, one-digit), E117 (consecutive number, four-digit).
 - In the field E118, the complete number is displayed again so you can check it is correct.
 -  You can only enter the serial number for new modules with the serial number 0000. This can only be done **once!** For this reason, make sure the number entered is correct before you confirm with ENTER!
Entry of an incorrect code will prevent the additional functions from being enabled. An incorrect serial number can only be corrected at the factory!

Press ENTER to confirm the serial number or cancel the entry to enter the number again.
7. If available, enter the release codes for the Plus Package and/or Chemoclean in the "Service" menu.
8. Check the Plus Package release (e.g. by opening the function group CHECK / Code P) or the Chemoclean function.
9. Make the customer device settings again.

9.5 Return

The device must be returned if repairs or a factory calibration are required, or if the wrong device has been ordered or delivered. According to legal regulations, Endress+Hauser, as an ISO-certified company, is required to follow certain procedures when handling returned products that are in contact with medium.

To ensure swift, safe and professional device returns, please read the return procedures and conditions on the internet site:

www.services.endress.com/return-material

9.6 Disposal

The device contains electronic components and must therefore be disposed of in accordance with regulations on the disposal of electronic waste.

Please observe local regulations.

10 Accessories

10.1 Sensors

Orbisint CPS11/CPS11D

- pH sensor for process applications
- Optional SIL version for connection to SIL approved transmitters
- With dirt-repellent PTFE diaphragm
- Ordering per product structure (--> Online configurator, www.products.endress.com/cps11 or www.products.endress.com/cps11d)
- Technical Information TI00028C/07/EN

Orbisint CPS12/CPS12D

- ORP electrode for process applications
- With dirt-repellent PTFE diaphragm
- Ordering per product structure (--> Online configurator, www.products.endress.com/cps12 or www.products.endress.com/cps12d)
- Technical Information TI00367C/07/EN

Ceraliquid CPS41/CPS41D

- pH sensor
- With ceramics diaphragm and liquid KCl electrolyte
- Ordering per product structure (--> Online configurator, www.products.endress.com/cps41 or www.products.endress.com/cps41d)
- Technical Information TI00079C/07/EN

Ceraliquid CPS42/CPS42D

- ORP electrode
- With ceramics diaphragm and liquid KCl electrolyte
- Ordering per product structure (--> Online configurator, www.products.endress.com/cps42 or www.products.endress.com/cps42d)
- Technical Information TI00373C/07/EN

Ceragel CPS71/CPS71D

- pH sensor
- With double chamber reference system and integrated bridge electrolyte
- Ordering per product structure (--> Online configurator, www.products.endress.com/cps71 or www.products.endress.com/cps71d)
- Technical Information TI00245C/07/EN

Ceragel CPS72/CPS72D

- ORP electrode
- With double chamber reference system and integrated bridge electrolyte
- Ordering per product structure (--> Online configurator, www.products.endress.com/cps72 or www.products.endress.com/cps72d)
- Technical Information TI00374C/07/EN

Orbipore CPS91/CPS91D

- pH sensor
- With open aperture for media with high dirt load
- Ordering per product structure (--> Online configurator, www.products.endress.com/cps91 or www.products.endress.com/cps91d)
- Technical Information TI00375C/07/EN

Orbipore CPS92/CPS92D

- ORP sensor
- With open aperture for media with high dirt load
- Ordering per product structure (--> Online configurator, www.products.endress.com/cps92 or www.products.endress.com/cps92d)
- Technical Information TI00435C/07/EN

Memosens CPS31D

- pH sensor with Memosens technology
- Gel-filled reference system with ceramic diaphragm
- Ordering acc. to product structure, www.products.endress.com/cps31d
- Technical Information TI00030C/07/EN

Tophit CPS471

- Sterilizable and autoclavable ISFET sensor
- For food and pharmaceuticals, process technology, water treatment and biotechnology;
- Ordering acc. to product structure, www.products.endress.com/cps471
- Technical Information TI00283C/07/EN

Tophit CPS441

- Sterilizable ISFET sensor for media with low conductivity
- With liquid KCl electrolyte
- Ordering acc. to product structure, www.products.endress.com/cps441
- Technical Information TI00352C/07/EN

Tophit CPS491

- ISFET sensor with open aperture for media with high dirt load
- Ordering acc. to product structure, www.products.endress.com/cps491
- Technical Information TI00377C/07/EN

10.2 Connection accessories

CPK9 measuring cable

- For sensors with TOP68 plug-in head, for high-temperature and high-pressure applications, IP 68
- Ordering acc. to product structure, see Technical Information (TI00118C/07/EN)

CPK1 measuring cable

- For pH/ORP electrodes with GSA plug-in head
- Ordering acc. to product structure, see Technical Information (TI00118C/07/EN)

CPK2 special measuring cable

- For pH/ORP electrodes with GSA plug-in head, with three sensor plugs
- Ordering acc. to product structure, see Technical Information (TI00118C/07/EN)

CPK12 special measuring cable

- For pH/ORP glass electrodes and ISFET sensors with TOP68 plug-in head
- Ordering acc. to product structure, see Technical Information (TI00118C/07/EN)

CYK10 Memosens data cable

- For digital sensors with Memosens technology
- Ordering according to product structure, see below

Certificates	
A	Standard, non-Ex
G	ATEX II 1G Ex ia IIC T6/T4/T3, FM/CSA IS/NI Cl I DIV 1&2 GP A-D
L	LABS free, non-Ex
O	FM IS/NI Cl I DIV 1&2 GP A-D
S	CSA IS/NI Cl I DIV 1&2 GP A-D
T	TIIS
V	ATEX/NEPSI II 3G Ex nL IIC
Cable length	
03	Cable length: 3 m (9.8 ft)
05	Cable length: 5 m (16 ft)
10	Cable length: 10 m (33 ft)
15	Cable length: 15 m (49 ft)
20	Cable length: 20 m (66 ft)
25	Cable length: 25 m (82 ft)
88	... m length
89	... ft length
Ready-made	
1	Wire terminals
2	M12 plug
CYK10-	complete order code

CYK81 measuring cable

- Non-terminated cable for extending the sensor cables (e.g. Memosens)
- 2x2 wires, twisted with shield and PVC sheath (2 x 2 x 0.5 mm² + shield)
- Goods sold by meter, order no.: 51502543

Junction box VBM

- For cable extension with 10 terminals
- Cable entries: 2 x Pg 13.5 or 2 x NPT ½"
- Material: aluminum
- Ingress protection: IP 65 (≅ NEMA 4X)
- Order numbers:
 - cable entries Pg 13.5: 50003987
 - cable entries NPT ½": 51500177

Junction box VBA

- For cable extension of pH/ORP sensors
- 10 terminals, protection class: IP 65 (≅ NEMA 4X)
- Cable entries: 2 x Pg 13.5, 2 x Pg 16
- Material: polycarbonate
- Order no.: 50005276

10.3 Mounting accessories

CYY101 weather protection cover for field devices, absolutely essential if operating the unit outdoors

- Material: stainless steel 1.4031 (AISI 304)
- Order No. CYY101-A

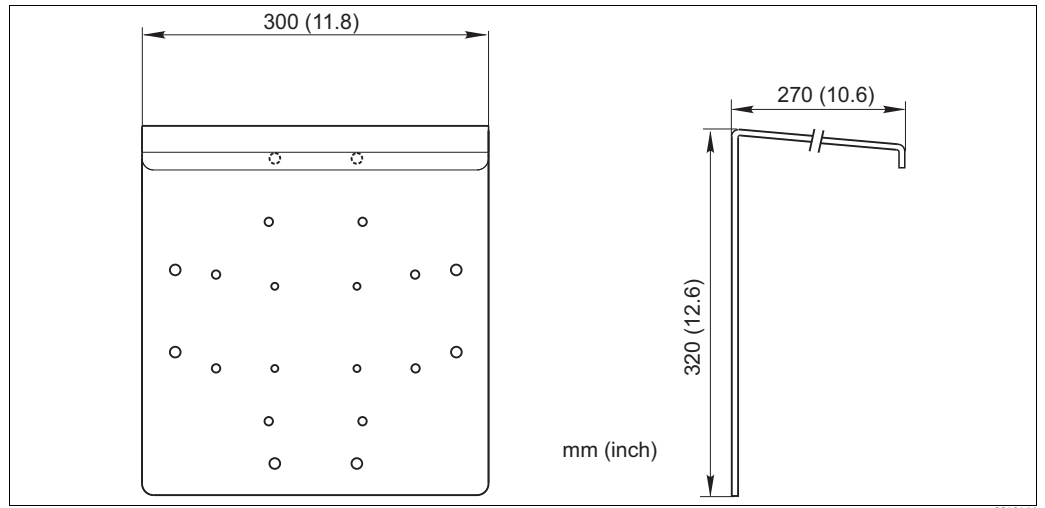

Fig. 49: Weather protection cover for field devices

CYY102 universal post

- Square pipe for mounting transmitters
- Material: stainless steel 1.4301 (AISI 304)
- Order No. CYY102-A

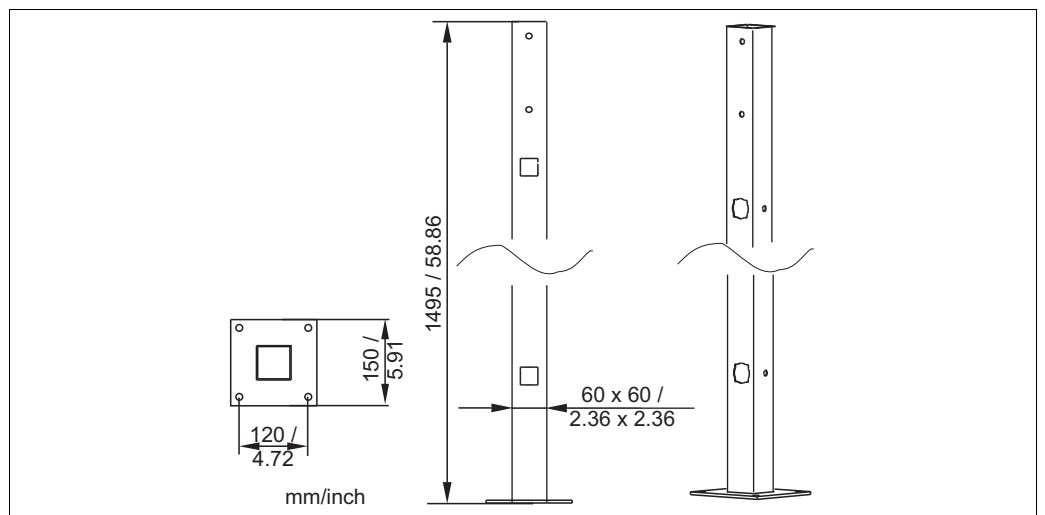

Fig. 50: Universal post

Post mounting kit

- For mounting of field housing on horizontal or vertical pipes (\varnothing max. 60 mm (2.36"))
- Material: stainless steel 1.4301
- order no. 50086842

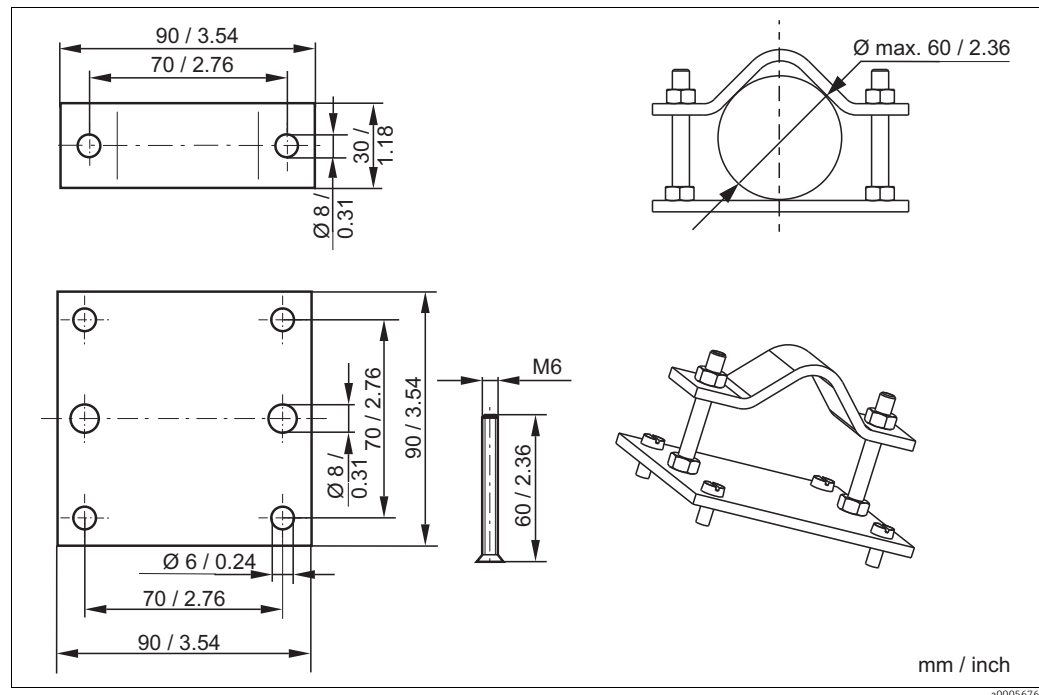

Fig. 51: Post mounting kit

10.4 Software and hardware add-ons

The add-ons can only be ordered by quoting the serial number of the device in question.

- Plus Package
Order no. 51500385
- Chemoclean
Order no. 51500963
- Two-relay card
Order no. 51500320
- Four-relay card
Order no. 51500321
- Two-relay card with current input
Order no. 51504304
- Four-relay card with current input
Order no. 51504305

10.5 Calibration solutions

High-quality buffer solutions of Endress+Hauser - CPY20

The secondary buffer solutions have been referenced to primary reference material of the PTB (German Federal Physico-technical Institute) and to standard reference material of NIST (National Institute of Standards and Technology) according to DIN 19266 by a DKD (German Calibration Service) accredited laboratory.

pH value	
A	pH 2.00 (accuracy ± 0.02 pH)
C	pH 4.00 (accuracy ± 0.02 pH)
E	pH 7.00 (accuracy ± 0.02 pH)
G	pH 9.00 (accuracy ± 0.02 pH)
I	pH 9.20 (accuracy ± 0.02 pH)
K	pH 10.00 (accuracy ± 0.05 pH)
M	pH 12.00 (accuracy ± 0.05 pH)

Quantity	
01	20 x 18 ml (0.68 fl.oz) only buffer solutions pH 4.00 and 7.00
02	250 ml (8.45 fl.oz)
10	1000 ml (0.26 US gal)
50	5000 ml (1.32 US gal) canister for Topcal S

Certificates	
A	Buffer analysis certificate

Version	
1	Standard

CPY20-					complete order code
--------	--	--	--	--	---------------------

Technical buffer solutions for ORP electrodes

- +220 mV, pH 7.0, 100 ml (3.4 fl.oz.); order no. CPY3-0
- +468 mV, pH 0.1, 100 ml (3.4 fl.oz.); order no. CPY3-1

KCl-electrolyte solutions for liquid filled electrodes

- 3.0 mol, T = -10 ... 100 °C (14 ... 212 °F), 100 ml (3.4 fl.oz.), order no. CPY4-1
- 3.0 mol, T = -10 ... 100 °C (14 ... 212 °F), 1000 ml (34 fl.oz.), order no. CPY4-2
- 1.5 mol, T = -30 ... 100 °C (-22 ... 266 °F), 100 ml (3.4 fl.oz.), order no. CPY4-3
- 1.5 mol, T = -30 ... 100 °C (-22 ... 266 °F), 1000 ml (34 fl.oz.), order no. CPY4-4

11 Technical data

11.1 Input

Measured variables	pH (analog or digital sensors) ORP Temperature	
Measuring range	pH:	-2 to 16
	ORP:	-1500 to +1500 mV / 0 to 100 %
	Temperature:	
	Pt 100	-50 to +150 °C (-58 to +302 °F)
	Pt 1000 (versions IS / PS)	-50 to +150 °C (-58 to +302 °F)
	NTC 30K (versions IS / PS)	-20 to +100 °C (-4 to +212 °F)
Input resistance	> 10 ¹² Ω (for nominal operating conditions) for standard sensors	
Cable specification	Length of cable (analog):	max. 50 m (164 ft)
	Length of cable (digital):	max. 100 m (328 ft)
Binary inputs	Voltage:	10 to 50 V
	Power consumption:	max. 10 mA
Current input	4 to 20 mA, galvanically separated Load: 260 Ω at 20 mA (voltage drop 5.2 V)	

11.2 Output

Output signal	0/4 to 20 mA, galvanically separated, active	
HART		
Signal coding	Frequency Shift Keying (FSK) + 0.5 mA via current output signal	
Data transfer rate	1200 Baud	
Galvanic isolation	yes	
PROFIBUS PA		
Signal coding	Manchester Bus Powered (MBP)	
Data transfer rate	31.25 kBit/s, voltage mode	
Galvanic isolation	yes (IO-Module)	
PROFIBUS DP		
Signal coding	RS485	
Data transfer rate	9.6 kBd, 19.2 kBd, 93.75 kBd, 187.5 kBd, 500 kBd, 1.5 MBd	
Galvanic isolation	yes (IO-Module)	

Signal on alarm	2.4 or 22 mA	
Load	maximum 500 Ω	
Output range	pH: ORP: absolute: relative: Temperature:	adjustable, min. Δ 1 pH adjustable, min. Δ 50 mV fixed, 0 to 100 % adjustable, Δ 10 to Δ 100 % of upper range value
Resolution	max. 700 digits/mA	
Min. distance for 0 / 4 to 20 mA signal	10% of measuring range	
Isolation voltage	max. 350 V _{RMS} /500 V DC	
Overvoltage protection	according to EN 61000-4-5	
Auxiliary voltage output	Output voltage: Output current:	15 V \pm 0.6 max. 10 mA
Contact outputs	Switching current with ohmic load ($\cos \varphi = 1$): Switching current with inductive load ($\cos \varphi = 0.4$): Switching voltage: Switching power with ohmic load ($\cos \varphi = 1$): Switching power with inductive load ($\cos \varphi = 0.4$):	max. 2 A max. 2 A max. 250 V AC, 30 V DC max. 500 VA AC, 60 W DC max. 500 VA AC, 60 W DC
Limit contactor	Pickup/dropout delay:	0 to 2000 s
Controller	Function (adjustable): Controller response: Control gain K_p : Integral action time T_n : Derivative action time T_v : Period for pulse length controller: Frequency for pulse frequency controller: Basic load:	pulse length/pulse frequency controller PID 0.01 to 20.00 0.0 to 999.9 min 0.0 to 999.9 min 0.5 to 999.9 s 60 to 180 min ⁻¹ 0 to 40% of max. set value
Alarm	Function (selectable): Alarm threshold adjustment range: Alarm delay:	latching / momentary contact pH / temperature: complete measuring range 0 to 2000 s 0 to 2000 min

Protocol specific data

HART	
Manufacturer ID	11 _h
Device type code	0091 _h
Transmitter specific revision	0001 _h
HART specification	5.0
DD files	www.products.endress.com/hart
Load HART	250 Ω
Device variables	None (dynamic variables PV, SV, only)
Features supported	-

PROFIBUS PA	
Manufacturer ID	11 _h
Ident number	1516 _h
Device revision	11 _h
Profile version	2.0
GSD files	www.products.endress.com/profibus
GSD file version	
Output values	Main value, temperature value
Input values	Display value of PLC
Features supported	Device locking: The device can be locked by hardware or software.

PROFIBUS DP	
Manufacturer ID	11 _h
Ident number	1520 _h
Profile version	2.0
GSD files	www.products.endress.com/profibus
GSD file version	
Output values	Main value, temperature value
Input values	Display value of PLC
Features supported	Device locking: The device can be locked by hardware or software.

11.3 Power supply

Supply voltage Depending on ordered version:
100/115/230 V AC +10/-15 %, 48 to 62 Hz
24 V AC/DC +20/-15 %

Fieldbus connection

HART	
Supply voltage	n/a, active current outputs
Integrated reverse voltage protection	n/a, active current outputs

PROFIBUS PA	
Supply voltage	9 V to 32 V, max. 35 V
Polarity sensitive	no
FISCO/FNICO compliant acc. to IEC 60079-27	no

PROFIBUS DP	
Supply voltage	9 V to 32 V, max. 35 V
Polarity sensitive	n/a
FISCO/FNICO compliant acc. to IEC 60079-27	no

Power consumption max. 7.5 VA

Mains protection Fine-wire fuse, medium-slow blow 250 V/3.15 A

11.4 Performance characteristics

Reference temperature	25 °C (77 °F)	
Resolution	pH: ORP: Temperature:	0.01 pH 1 mV/0.1 % 0.1 °C
Maximum measured error¹⁾	Display pH: ORP: Temperature: Signal output pH: ORP: Temperature:	max. 0.5 % of measuring range max. 0.5 % of measuring range max. 1.0 % of measuring range max. 0.75 % of measuring range max. 0.75 % of measuring range max. 1.25 % of measuring range
Repeatability¹⁾	pH: ORP:	max. 0.2 % of measuring range max. 0.2 % of measuring range
Zero point	Glass: Antimon: ISFET:	pH 5.0 to 9.0 (nominal pH 7.00) pH -1.0 to 3.0 (nominal pH 1.00) -500 to +500 mV
Slope	Glass: Antimon: ISFET:	38.00 to 65.00 mV/pH (nominal 59.16 mV/pH) 25.00 to 65.00 mV/pH (nominal 59.16 mV/pH) 38.00 to 65.00 mV/pH (nominal 59.16 mV/pH)
Offset	pH: ORP: Temperature:	±2 pH ±120 mV/±50 % ±5 °C

1) acc. to IEC 746-1, for nominal operating conditions

11.5 Environment

Ambient temperature	-10 to +55 °C (+14 to +131 °F)	
Storage temperature	-25 to +65 °C (-13 to +149 °F)	
Electromagnetic compatibility	Interference emission and interference immunity as per EN 61326-1:2006, EN 61326-2-3:2006	
Ingress protection	Panel mounted instrument: Field instrument:	IP 54 (front), IP 30 (housing) IP 65 / tightness acc. to NEMA 4X
Electrical safety	according EN/IEC 61010-1:2001, Installation Category II, for use up to 2000 m above sea level	
CSA	Apparatus with CSA General Purpose Approval are certified for indoor use.	
Relative humidity	10 to 95%, non-condensing	
Pollution degree	The product is suitable for pollution degree 2.	

11.6 Mechanical construction

Dimensions	Panel mounted instrument: Field instrument:	96 x 96 x 145 mm (3.78 x 3.78 x 5.71 inches) Mounting depth: approx. 165 mm (6.50") 247 x 170 x 115 mm (9.72 x 6.69 x 4.53 inches)
Weight	Panel mounted instrument: Field instrument:	max. 0.7 kg (1.5 lb) max. 2.3 kg (5.1 lb)
Material	Housing of panel mounted instrument: Field housing: Front membrane:	Polycarbonate ABS PC FR Polyester, UV-resistant
Terminals	Cross section	2.5 mm ² (14 AWG)

12 Appendix

Operating matrix

Function group OFFSET V	Entry of absolute value current measured value -2.00...16 pH -1500...1500 mV 0.0...100.0 %	Current offset is displayed 0.00 pH , -2.00...2.00 pH 0 mV , -120...120 mV 0.0 % , -50.0...50.0 %	Calibration status is displayed o.k. E--	Store offset results yes ; no; new	V1	V2	V3	V4				
Function group NUMERIC CALIBRATION N	Enter reference temperature 25 °C -20.0...150.0 °C	Enter slope Glass 59.18 mV/pH 38.00...65.00 mV/pH Antimon 59.18 mV/pH 25.00...65.00 pH ISFET 59.18 mV/pH 38.00...65.00 mV/pH	Enter zero point Glass 7.00 pH 5.00...9.00 pH Antimon 1.00 pH -1.00...3.00 pH ISFET 0 mV -500...+500 V	Calibration status is displayed o.k. E--	Store calibration results yes ; no; new	N1	N2	N3	N4	N5		
Function group CALIBRATION C	Calibration of 80% value (toxic sample) -1500...1500 mV	Calibration Acceptance when stable at ± 5 mV for more than 5 s	Calibration of 20% value (non-toxic sample) -1500...1500 mV	Calibration Acceptance when stable at ± 5 mV for more than 5 s	Calibration status is displayed o.k. E--	Store calibration results yes ; no; new	C31	C32	C33	C34	C35	C36
	Redox mV calibration Enter value of redox buffer current measured value -1500 mV...1500 mV	Calibration Acceptance when stable ± 1 mV for more than 5 s	Zero point is displayed -100...100 mV	Calibration status is displayed o.k. E--	Store calibration results yes ; no; new	C21	C22	C23	C24	C25		
	pH calibration (displayed calibration type options depend on selection in A1)	Enter calibration temperature (if B3 = MTC) 25.0 °C -20.0...150.0 °C	Enter pH value of first buffer solution Buffer value of last calibration: 0.00...14.00 pH	Calibration Acceptance when stable at ± 0.05 pH for more than 10 s	Enter pH value of the second buffer solution Buffer value of last calibration 0.00 pH...14.00 pH	Calibration Acceptance when stable at ± 0.05 pH for more than 10 s	Display of slope Glass 59.16 mV/pH 38.00...65.00 mV/pH Antimon 59.16 mV/pH 25.00...65.00 mV/pH ISFET 59.16 mV/pH 38.00...65.00 mV/pH	C11	C12	C13	C14	C15
MEAS. VALUE DISPLAY with TEMPERATURE DISPLAY in °C	Temperature display in °F	Temperature display suppressed	Measured value display in mV	Measured value display Current input in %	Measured value display Current input in mA	1st error is displayed (if present)	Other errors are displayed (up to 10 errors)					
Function group SETUP 1 A	Select operating mode pH ; ORP (mV); ORP (%)	Select connection type sym = symmetrical asym = asymmetrical	Enter measured value damping 1 (no damping) 1-60	Select sensor Glass ($E_s = 7.0$) Antim = Antimon ISFET	Select temperature sensor Pt 100 Pt 1k NTC 30K	A1	A2	A3	A4	A5		
Function group SETUP 2 B	Select temperature compensation (for the process) pH : ATC; MTC	Enter MTC temperature (if B1=MTC and A1=pH) 25.0 °C -50.0...+150.0 °C	Select temperature compensation (for the calibration) ATC; MTC	Enter correct process temperature (if B1=ATC) 25.0 °C -50.0 °C...+150.0 °C	Display of temperature difference (Offset) 0.0 °C -5.0...5.0 °C	B1	B2	B3	B4	B5		
Function group CURRENT INPUT Z	Controller switch-off by current input Off ; input	Delay of controller switch-off by current input 0 s 0...2000 s	Delay of controller switch-on by current input 0 s 0...2000 s	Switch-off limit value for current input 50% 0...100%	Switch-off direction for current input Low; high	Feedforward control to PID controller Off ; lin = linear	Z1	Z2	Z3	Z4	Z5	Z6
Function group CURRENT OUTPUT O	Select current output Out 1 ; Out 2	Select measured variable for 2nd current output °C; pH, mV; Contr	Select characteristic Tab = table O3 (3) sim = simulation O3 (2) lin = linear O3 (1)	Select table options read ; edit O331	Enter number of value pairs in table 1 1...10 O332	Select table value pair 1 1... number of table value pairs; assign O333	O1	O2	O311	O312	O313	
	Select current range 4-20 mA ; 0-20 mA	Enter simulation value current value 0...22.00 mA O321	Select current range +2.00 pH ; -2.00...16.00 pH -1500 mV ; -1500...1500 mV 0.0 % ; 0.0...100.0 % 0.0 °C ; -50...150.0 °C	Enter 0/4 mA value 12.00 pH ; -2.00...16.00 pH 1500 mV ; -1500...1500 mV 100.0 % ; 0.0...100 % 100.0 °C ; -50...150.0 °C	Enter 20 mA value 12.00 pH ; -2.00...16.00 pH 1500 mV ; -1500...1500 mV 100.0 % ; 0.0...100 % 100.0 °C ; -50...150.0 °C	O11	O12	O13	O14	O15		
	Select contact type Latch = latching contact; Momen = momentary cont.	Select alarm delay unit s; min	Alarm delay 0 s (min) 0 s...2000 s (min) (depends on F2)	Set error current 22 mA ; 2.4 mA	Select error number 1 1...255	Set alarm contact to be effective yes ; no	F1	F2	F3	F4	F5	F6

Zero point is displayed Glass 7.00 pH 5.00...9.00 pH Antimony 1.00 pH -1.00...3.00 pH ISFET current value -500...+500 mV C17	Calibration status is displayed o.k. E-- C18	Store calibration results yes; no; new C19
---	--	---

Feedforward control = 1 at 50% 0 ... 100% Z7

Enter x value (measured value) 0.00 pH: -2.00...16.00 pH 0 mV: -1500...1500 mV 0.0 %; 0.0...100.0 % O334	Enter y value (current value) 0.00 mA 0.00...20.00 mA O335	Table status o.k. yes; no O336
---	--	--

Activate error current for previously set error no; yes F7	Automatic start of cleaning function no; yes (not always displayed see error messages) F8	Select "next error" or return to menu next = next error; ~R F9
---	--	--

Field for customer settings

Function group CHECK P	SCS alarm Measuring sensor off, on P1	SCS alarm Reference sensor (if A2=sym) off, on P2	SCS alarm threshold 50 kW 1.5...50 kW P3	Leakage current is displayed (ISFET sensors only) 0.0 ... 9.9 mA P4	Select process monitoring Off; Low; High; LoHi; LoI; HiI; LoHI P5	Alarm delay 0 min (s) 0 ... 2000 min (s) P6			
	Function group RELAY R	Select contact to be configured Rel1; Rel2; Rel3; Rel4; R1	Limit contactor configuration Neutr = neutralisation controller (with Rel1 and Rel2 and A1 = pH only) R2 (6)	Function R2 (6) switch off or on off, on R261	Set point 1 (or 2) 6.00 pH -2.00...16.00 pH R262	Enter control gain Kp1 (or Kp2) 1.00 0.01...20.00 R263	Enter integral action time Tn (0.0 = no I component) 0.0 min 0.0...999.9 min R264		
			Clean = Chemoclean (with Rel3 only) R2 (5)	Function R2 (5) switch off or on off, on R251	Select start pulse int = internal; ext = external; i+ext = internal +external; i+stp = internal, suppressed by ext R252	Enter pre-rinse time 30 s 0...999 s R253	Enter cleaning time 10 s 0...999 s R254		
			Timer R2 (4)	Function R2 (4) switch off or on off, on R241	Set rinse time 30 s 0...999 s R242	Set pause time 360 min 1...7200 min R243	Set minimum pause time 120 min 1...3600 min R244		
			PID controller R2 (3)	Function R2 (3) switch off or on off, on; basic; PID+B R231	Enter set point pH 16.00; -2.00...16.00 pH 1500 mV; -1500...1500 mV 100.0 %; 0...100.0 % R232	Enter control gain Kp 1.00 0.01...20.00 R233	Enter integral action time Tn (0.0 = no I component) 0.0 min 0.0...999.9 min R234		
			LC °C = Limit contactor T R2 (2)	Function R2 (2) switch off or on off, on R221	Enter switch-on temperature 150.0 °C -50.0...+150.0°C R222	Enter switch-off temperature 150.0 °C -50.0...+150.0°C R223	Enter pick-up delay 0 s 0...2000 s R224		
			Function group SERVICE S	Select language ENG; GER ITA; FRA ESP; NEL S1	LC PV = Limit contactor pH/Redox R2 (1)	Function R2 (1) switch off or on off, on R211	Select contact switch-on point 16.00 pH; -2.00...16.00 pH 1500 mV; -1500...1500 mV 100.0 %; 0...100.0 % R212	Select contact switch-off point pH 16.00; pH -2.00...16.00 1500 mV; -1500...1500 mV 100.0 %; 0...100.0 % R213	Enter pick-up delay 0 s 0...2000 s R214
					Hold configuration s+c=during setup and calibration CAL=during calibration Setup=during setup none=no hold S2	Manual hold off, on S3	Enter hold dwell period 10 s 0...999 s S4	Enter release code for SW upgrade (Plus package) 0000 0000...9999 S5	Enter release code for SW upgrade ChemoClean 0000 0000...9999 S6
					Select module	Software version	Hardware version	Serial number is displayed	Module name is displayed
					Sens = sensor E1(5)	SW version E151	HW version E152	E153	E154
Rel = relay E1(4)					SW version E141	HW version E142	E143	E144	
MainB = mainboard E1(3)	SW version E131	HW version E132			E133	E134			
Trans = transmitter E1(2)	SW version E121	HW version E122			E123	E124			
Contr = controller E1(1)	SW version E111	HW version E112			E113	E114			
Function group E + H SERVICE E	Enter address HART: 0...15 or PROFIBUS 1...126 I1	Tag is displayed @@@@@@@@ I2							
Function group INTERFACE I									

Set lower alarm threshold pH -2.00 pH -2 ... 16 P7	Set upper alarm threshold pH 16.00 pH -2 ... 16 P8	Select process monitoring Off; AC; CC; AC CC ACI; CC; ACCCI P9	Set max. perm. period of lower limit exceeded 60 min 0 ... 2000 min P10	Set max. perm. period of upper limit exceeded 120 min 0 ... 2000 min P11	Set monitoring value pH 1.00 pH -2... 16 P12
Enter derivative action time Tv (0.0 = no D component) 0.0 min 0.0...999.9 min R265	Select len = pulse length freq = pulse frequency curr = current output 2 R266	Enter pulse interval 10.0 s 0.5...999.9 s R267	Enter maximum pulse frequency 120 1/min 60...180 1/min R268	Enter minimum ON time t _o 0.3 s 0.1...5.0 s R269	Enter process type Batch Inline R2610
Enter post-rinse time 20 s 0...999 s R255	Set number of repeat cycles 0 0...5 R256	Set interval between two cleaning cycles (pause time) 360 min 1...7200 min R257	Enter minimum pause time 120 min 1...R357 min R258	Enter number of cleaning cycles without cleaning agent 0 0...9 R259	

Enter derivative action time Tv (0.0 = no D component) 0.0 min 0.0...999.9 min R235	Select control characteristic dir = direct; inv = inverted; R236	Select len = pulse length freq = pulse frequency curr = current output 2 R237	Enter pulse interval 10.0 s 0.5...999.9 s R238	Enter maximum pulse frequency 120 1/min 60...180 1/min R239	Enter minimum ON time t _o 0.3 s 0.1...5.0 s R2310	Enter basic load 0% 0 ... 40% R2311	Enter process type Batch Inline R2312
Enter dropout delay 0 s 0...2000 s R225	Enter alarm threshold (as an absolute value) 150.0 °C -20.0...+150.0 °C R226	LC status is displayed MAX MIN R227					
Enter dropout delay 0 s 0...2000 s R215	Enter alarm threshold (as an absolute value) 16.00 pH; -2.00...16.00 pH 1500 mV; -1500...1500 mV 100.0 %; 0...100.0 % R216	LC status is displayed MAX MIN R217					
Order number is displayed S7	Serial number is displayed S8	Reset instrument to default values no; Sens = sensor data; Factsy = factory settings. S9	Perform instrument test no; display S10	Reference voltage is displayed S11	Select AC frequency S12		

Index

A

Access codes	34
Accessories	100
Calibration solutions	105
Connection accessories	102
Mounting accessories	103
Sensors	100
Software	104
Alarm	107
Alarm contact	28
Alarm function	51
Ambient temperature	111
Assembly	90
Automatic mode	33
Auxiliary voltage output	107

B

Binary inputs	106
---------------	-----

C

Cable specification	106
Calibration	73
CE mark	8
Central module	98
Check function	53
Checking	
Connection	28
Function	36
Installation	15
Chemoclean function	60
Cleaning	
pH/ORP sensors	89
Transmitter	88
Cleaning function	60
Commissioning	37–39
Digital sensors	36
ISFET sensors	36
Communication	72
Connection diagram	
Memosens	24
Without Memosens	17
Contact outputs	107
Controller	107
CSA	111
CSA general purpose	8
Current	106
Current input	44
Current outputs	47

D

Declaration of conformity	8
Designated use	5
Diagnosis code	79
Diagnostics	79
Dimensions	111
Dismantling	
Field instrument	95
Panel-mounted instrument	92
Display	29
Disposal	99

E

E+H Service menu	71
Electrical safety	111
Electrical connection	17–28
With Memosens	24
Without Memosens	17
Electrical icons	6
Electromagnetic compatibility	5
EMC	111
Environment	111
Errors	
Instrument specific	86
Process specific	83
System error messages	79

F

Factory settings	38
Field device connection	18, 25
Fieldbus	109
Freezing of outputs	35

H

Hold function	35, 69
---------------	--------

I

Icons	6
Electrical	6
Incoming acceptance	7
Ingress protection	111
Input	106
Installation	9–15
Installation conditions	
Field instrument	10
Panel-mounted instrument	11
Installation instructions	
Field instrument	12
Panel-mounted instrument	15
Instrument specific errors	86
Interfaces menu	72
Isolation voltage	107

K

Key assignment	31
----------------	----

L	
Limit	107
Limit contactor	56
Liquid KCl supply	90
Load	107
Local Operation	33
M	
Mains	109
Maintaining digital sensors	90
Manual mode	33
Material	111
Maximum measured error	110
Measured variables	106
Measuring range	106
Measuring cable	
Sensors with Memosens	26
Sensors without Memosens	20
Measuring system	9
Mechanical construction	111
Menu	
Calibration	74
Current input	44
Current outputs	47
E+H Service	71
Interfaces	72
Monitoring functions	51
Relay	56, 62
Service	69
Setup 1	41
Setup 2	43
Menu structure	35
Monitoring functions	51
N	
Nameplate	8
Neutralization	61
Numeric calibration	77
O	
Offset	78, 110
Operating elements	30
Operating modes	34
Operation	
Display	29
Key assignment	31
Operating concept	33
Operating elements	30
Operational safety	5
Output	106–108
Overvoltage protection	107

P	
Performance characteristics	110
PID controller	57
Pollution	111
Post mounting	13
Power consumption	109
Power supply	109
Process specific errors	83
Product identification	8
Product safety	6
Protocol specific data	108
Q	
Quick commissioning	39
Quick setup	39
Quick start-up	39
R	
Reference temperature	110
Relative humidity	111
Relay configuration	56
Repair	92
Repeatability1	110
Requirements for the personnel	5
Resolution	107, 110
Return	99
S	
Safety icons	6
Safety instructions	
Operational safety	5
Scope of delivery	7
Service menu	69
Setup 1	41
Setup 2	43
Signal on alarm	107
Slope	110
Spare parts	92–98
Storage temperature	111
Supply voltage	109
Switching on	37
Symbols	6
System configuration	41
System error messages	79
T	
Technical data	106–111
Terminals	111
Troubleshooting	79
W	
Wall mounting	12
Weight	111
Wiring	16–28
Workplace safety	5
Z	
Zero point	110



71212636

www.addresses.endress.com
