

Operating Instructions

LNGmass

Modbus RS485

Coriolis flowmeter

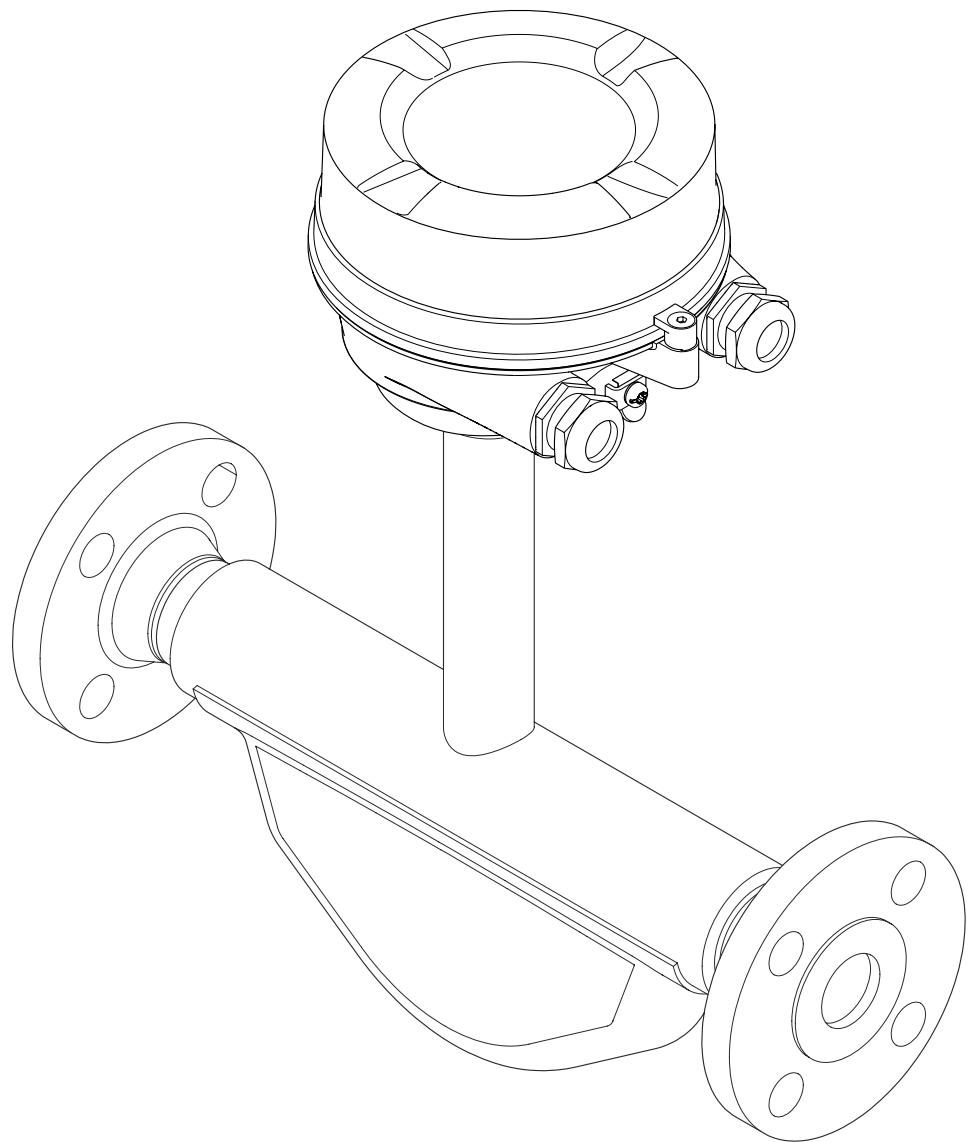

- Make sure the document is stored in a safe place such that it is always available when working on or with the device.
- To avoid danger to individuals or the facility, read the "Basic safety instructions" section carefully, as well as all other safety instructions in the document that are specific to working procedures.
- The manufacturer reserves the right to modify technical data in line with technological developments without prior notice. Your Endress+Hauser sales center will supply you with current information and updates to this manual.

Table of contents

1	Document information	5		
1.1	Document function	5		
1.2	Symbols used	5		
1.2.1	Safety symbols	5		
1.2.2	Electrical symbols	5		
1.2.3	Tool symbols	6		
1.2.4	Symbols for certain types of information	6		
1.2.5	Symbols in graphics	6		
1.3	Documentation	7		
1.3.1	Standard documentation	7		
1.3.2	Supplementary device-dependent documentation	7		
1.4	Registered trademarks	7		
2	Basic safety instructions	8		
2.1	Requirements for the personnel	8		
2.2	Designated use	8		
2.3	Workplace safety	9		
2.4	Operational safety	9		
2.5	Product safety	9		
2.6	IT security	9		
3	Product description	11		
3.1	Product design	11		
3.1.1	Device version with Modbus RS485 communication type	11		
4	Incoming acceptance and product identification	12		
4.1	Incoming acceptance	12		
4.2	Product identification	12		
4.2.1	Transmitter nameplate	13		
4.2.2	Sensor nameplate	14		
4.2.3	Promass 100 safety barrier - nameplate	15		
4.2.4	Symbols on measuring device	15		
5	Storage and transport	16		
5.1	Storage conditions	16		
5.2	Transporting the product	16		
5.3	Packaging disposal	17		
6	Installation	18		
6.1	Installation conditions	18		
6.1.1	Mounting position	18		
6.1.2	Requirements from environment and process	19		
6.1.3	Special mounting instructions	20		
6.2	Mounting the measuring device	20		
6.2.1	Required tools	20		
6.2.2	Preparing the measuring device	20		
6.2.3	Mounting the measuring device	20		
6.3	Post-installation check	21		
7	Electrical connection	22		
7.1	Connection conditions	22		
7.1.1	Required tools	22		
7.1.2	Requirements for connecting cable	22		
7.1.3	Terminal assignment	24		
7.1.4	Shielding and grounding	25		
7.1.5	Preparing the measuring device	25		
7.2	Connecting the measuring device	26		
7.2.1	Connecting the transmitter	26		
7.2.2	Connecting the Safety Barrier Promass 100	27		
7.3	Hardware settings	28		
7.3.1	Enabling the terminating resistor	28		
7.4	Ensuring the degree of protection	29		
7.5	Post-connection check	29		
8	Operability	30		
8.1	Overview of operation options	30		
8.2	Structure and function of the operating menu	31		
8.2.1	Structure of the operating menu	31		
8.2.2	Operating philosophy	32		
8.3	Access to the operating menu via the operating tool	33		
8.3.1	Connecting the operating tool	33		
8.3.2	FieldCare	33		
9	System integration	35		
9.1	Overview of device description files	35		
9.1.1	Current version data for the device	35		
9.1.2	Operating tools	35		
9.2	Modbus RS485 information	35		
9.2.1	Function codes	35		
9.2.2	Register information	36		
9.2.3	Response time	36		
9.2.4	Modbus data map	36		
10	Commissioning	39		
10.1	Function check	39		
10.2	Establishing a connection via FieldCare	39		
10.3	Configuring the measuring device	39		
10.3.1	Defining the tag name	39		
10.3.2	Setting the system units	39		
10.3.3	Configuring the communication interface	41		
10.3.4	Configuring the low flow cut off	43		
10.3.5	Configuring the partial filled pipe detection	44		

10.4	Advanced settings	45	14.4	Return	63
10.4.1	Calculated values	45	14.5	Disposal	63
10.4.2	Carrying out a sensor adjustment	46	14.5.1	Removing the measuring device	63
10.4.3	Configuring the totalizer	46	14.5.2	Disposing of the measuring device	64
10.5	Simulation	47	15	Accessories	65
10.6	Protecting settings from unauthorized access	47	15.1	Communication-specific accessories	65
10.6.1	Write protection via write protection switch	48	15.2	Service-specific accessories	65
11	Operation	49	16	Technical data	66
11.1	Reading device locking status	49	16.1	Application	66
11.2	Reading measured values	49	16.2	Function and system design	66
11.2.1	Process variables	49	16.3	Input	66
11.2.2	Totalizer	50	16.4	Output	67
11.3	Adapting the measuring device to the process conditions	50	16.5	Power supply	68
11.4	Performing a totalizer reset	51	16.6	Performance characteristics	69
12	Diagnostics and troubleshooting	52	16.7	Installation	72
12.1	General troubleshooting	52	16.8	Environment	72
12.2	Diagnostic information via light emitting diodes	52	16.9	Process	73
12.2.1	Transmitter	52	16.10	Mechanical construction	74
12.2.2	Safety Barrier Promass 100	53	16.11	Operability	76
12.3	Diagnostic information in FieldCare	53	16.12	Certificates and approvals	76
12.3.1	Diagnostic options	53	16.13	Application packages	76
12.3.2	Calling up remedy information	54	16.14	Accessories	77
12.4	Diagnostic information via communication interface	54	16.15	Supplementary documentation	77
12.4.1	Reading out diagnostic information	54	17	Appendix	78
12.4.2	Configuring error response mode	55	17.1	Overview of the operating menu	78
12.5	Adapting the diagnostic information	55	Index	89	
12.5.1	Adapting the diagnostic behavior	55			
12.6	Overview of diagnostic information	56			
12.7	Pending diagnostic events	57			
12.8	Diagnostic list	58			
12.9	Event logbook	58			
12.9.1	Event history	58			
12.9.2	Filtering the event logbook	59			
12.9.3	Overview of information events	59			
12.10	Resetting the measuring device	60			
12.11	Device information	60			
12.12	Firmware history	61			
13	Maintenance	62			
13.1	Maintenance tasks	62			
13.1.1	Exterior cleaning	62			
13.1.2	Interior cleaning	62			
13.2	Measuring and test equipment	62			
13.3	Endress+Hauser services	62			
14	Repair	63			
14.1	General notes	63			
14.2	Spare parts	63			
14.3	Endress+Hauser services	63			





1 Document information

1.1 Document function







These Operating Instructions contain all the information that is required in various phases of the life cycle of the device: from product identification, incoming acceptance and storage, to mounting, connection, operation and commissioning through to troubleshooting, maintenance and disposal.

1.2 Symbols used



1.2.1 Safety symbols

Symbol	Meaning
 A0011189-EN	DANGER! This symbol alerts you to a dangerous situation. Failure to avoid this situation will result in serious or fatal injury.
 A0011190-EN	WARNING! This symbol alerts you to a dangerous situation. Failure to avoid this situation can result in serious or fatal injury.
 A0011191-EN	CAUTION! This symbol alerts you to a dangerous situation. Failure to avoid this situation can result in minor or medium injury.
 A0011192-EN	NOTICE! This symbol contains information on procedures and other facts which do not result in personal injury.











1.2.2 Electrical symbols

Symbol	Meaning
 A0011197	Direct current A terminal to which DC voltage is applied or through which direct current flows.
 A0011198	Alternating current A terminal to which alternating voltage is applied or through which alternating current flows.
 A0017381	Direct current and alternating current <ul style="list-style-type: none"> ▪ A terminal to which alternating voltage or DC voltage is applied. ▪ A terminal through which alternating current or direct current flows.
 A0011200	Ground connection A grounded terminal which, as far as the operator is concerned, is grounded via a grounding system.
 A0011199	Protective ground connection A terminal which must be connected to ground prior to establishing any other connections.
 A0011201	Equipotential connection A connection that has to be connected to the plant grounding system: This may be a potential equalization line or a star grounding system depending on national or company codes of practice.





1.2.3 Tool symbols

Symbol	Meaning
 A0011221	Allen key
 A0011222	Open-ended wrench



1.2.4 Symbols for certain types of information

Symbol	Meaning
 A0011182	Allowed Indicates procedures, processes or actions that are allowed.
 A0011183	Preferred Indicates procedures, processes or actions that are preferred.
 A0011184	Forbidden Indicates procedures, processes or actions that are forbidden.
 A0011193	Tip Indicates additional information.
 A0011194	Reference to documentation Refers to the corresponding device documentation.
 A0011195	Reference to page Refers to the corresponding page number.
 A0011196	Reference to graphic Refers to the corresponding graphic number and page number.
	Series of steps
	Result of a sequence of actions
 A0013562	Help in the event of a problem
 A0015502	Visual inspection

1.2.5 Symbols in graphics

Symbol	Meaning
1, 2, 3,...	Item numbers
	Series of steps
A, B, C, ...	Views
A-A, B-B, C-C, ...	Sections
 A0013441	Flow direction
 A0011187	Hazardous area Indicates a hazardous area.
 A0011188	Safe area (non-hazardous area) Indicates a non-hazardous area.

1.3 Documentation

-  For an overview of the scope of the associated Technical Documentation, refer to the following:
- The CD-ROM provided for the device (depending on the device version, the CD-ROM might not be part of the delivery!)
 - The *W@M Device Viewer* : Enter the serial number from the nameplate (www.endress.com/deviceviewer)
 - The *Endress+Hauser Operations App*: Enter the serial number from the nameplate or scan the 2-D matrix code (QR code) on the nameplate.
-  For a detailed list of the individual documents along with the documentation code (→  77)

1.3.1 Standard documentation

Document type	Purpose and content of the document
Technical Information	Planning aid for your device The document contains all the technical data on the device and provides an overview of the accessories and other products that can be ordered for the device.
Brief Operating Instructions	Guide that takes you quickly to the 1st measured value The Brief Operating Instructions contain all the essential information from incoming acceptance to initial commissioning.
Modbus RS485 register information	Reference for Modbus RS485 register information The document provides Modbus-specific information for each individual parameter in the operating menu.

1.3.2 Supplementary device-dependent documentation

Additional documents are supplied depending on the device version ordered: Always comply strictly with the instructions in the supplementary documentation. The supplementary documentation is an integral part of the device documentation.

1.4 Registered trademarks

Modbus®

Registered trademark of SCHNEIDER AUTOMATION, INC.

2 Basic safety instructions

2.1 Requirements for the personnel

The personnel for installation, commissioning, diagnostics and maintenance must fulfill the following requirements:

- ▶ Trained, qualified specialists must have a relevant qualification for this specific function and task
- ▶ Are authorized by the plant owner/operator
- ▶ Are familiar with federal/national regulations
- ▶ Before beginning work, the specialist staff must have read and understood the instructions in the Operating Instructions and supplementary documentation as well as in the certificates (depending on the application)
- ▶ Following instructions and basic conditions

The operating personnel must fulfill the following requirements:

- ▶ Being instructed and authorized according to the requirements of the task by the facility's owner-operator
- ▶ Following the instructions in these Operating Instructions

2.2 Designated use

Application and media

The measuring device described in these Instructions is intended only for flow measurement of liquids and gases.

Depending on the version ordered, the measuring device can also measure potentially explosive, flammable, poisonous and oxidizing media.

Measuring devices for use in hazardous areas, in hygienic applications or in applications where there is an increased risk due to process pressure, are labeled accordingly on the nameplate.

To ensure that the measuring device remains in proper condition for the operation time:

- ▶ Only use the measuring device in full compliance with the data on the nameplate and the general conditions listed in the Operating Instructions and supplementary documentation.
- ▶ Based on the nameplate, check whether the ordered device is permitted for the intended use in the hazardous area (e.g. explosion protection, pressure vessel safety).
- ▶ Use the measuring device only for media against which the process-wetted materials are adequately resistant.
- ▶ If the measuring device is not operated at atmospheric temperature, compliance with the relevant basic conditions specified in the associated device documentation is absolutely essential: "Documentation" section (→  7).

Incorrect use

Non-designated use can compromise safety. The manufacturer is not liable for damage caused by improper or non-designated use.

WARNING

Danger of breakage of the measuring tube due to corrosive or abrasive fluids.

Housing breakage due to mechanical overload possible!

- ▶ Verify the compatibility of the process fluid with the measuring tube material.
- ▶ Ensure the resistance of all fluid-wetted materials in the process.
- ▶ Observe the specified pressure and temperature range.

Verification for borderline cases:

- ▶ For special fluids and fluids for cleaning, Endress+Hauser is glad to provide assistance in verifying the corrosion resistance of fluid-wetted materials, but does not accept any

warranty or liability as minute changes in the temperature, concentration or level of contamination in the process can alter the corrosion resistance properties.

Residual risks

The external surface temperature of the housing can increase by max. 20 K due to the power consumption of the electronic components. Hot process fluids passing through the measuring device will further increase the surface temperature of the housing. The surface of the sensor, in particular, can reach temperatures which are close to the fluid temperature.

Possible burn hazard due to fluid temperatures!

- ▶ For elevated fluid temperature, ensure protection against contact to prevent burns.

2.3 Workplace safety

For work on and with the device:

- ▶ Wear the required personal protective equipment according to federal/national regulations.

For welding work on the piping:

- ▶ Do not ground the welding unit via the measuring device.

If working on and with the device with wet hands:

- ▶ It is recommended to wear gloves on account of the higher risk of electric shock.

2.4 Operational safety

Risk of injury.

- ▶ Operate the device in proper technical condition and fail-safe condition only.
- ▶ The operator is responsible for interference-free operation of the device.

Conversions to the device

Unauthorized modifications to the device are not permitted and can lead to unforeseeable dangers.

- ▶ If, despite this, modifications are required, consult with Endress+Hauser.

Repair

To ensure continued operational safety and reliability,

- ▶ Carry out repairs on the device only if they are expressly permitted.
- ▶ Observe federal/national regulations pertaining to repair of an electrical device.
- ▶ Use original spare parts and accessories from Endress+Hauser only.

2.5 Product safety

This measuring device is designed in accordance with good engineering practice to meet state-of-the-art safety requirements, has been tested, and left the factory in a condition in which it is safe to operate.

It meets general safety standards and legal requirements. It also complies with the EC directives listed in the device-specific EC Declaration of Conformity. Endress+Hauser confirms this by affixing the CE mark to the device.

2.6 IT security

We only provide a warranty if the device is installed and used as described in the Operating Instructions. The device is equipped with security mechanisms to protect it against any inadvertent changes to the device settings.

IT security measures in line with operators' security standards and designed to provide additional protection for the device and device data transfer must be implemented by the operators themselves.

Endress+Hauser can be contacted to provide support in performing this task.

3 Product description

3.1 Product design

3.1.1 Device version with Modbus RS485 communication type

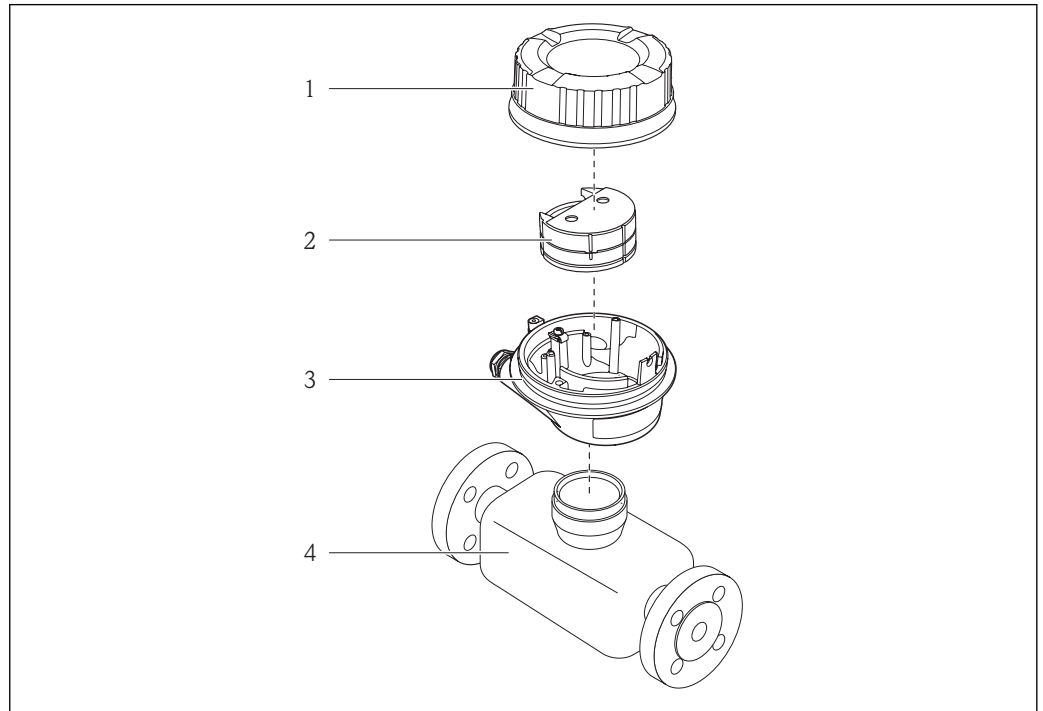

A0017609





1 Important components of a measuring device

- 1 Transmitter housing cover
- 2 Main electronics module
- 3 Transmitter housing
- 4 Sensor

 In the case of the device version with Modbus RS485 intrinsically safe, the Safety Barrier Promass 100 forms part of the scope of supply.

4 Incoming acceptance and product identification

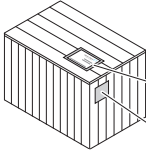
4.1 Incoming acceptance

A0015502

1
+
2



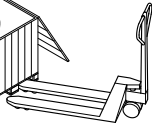

1
+
2

A0013843

Are the order codes on the delivery note (1) and the product sticker (2) identical?

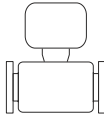
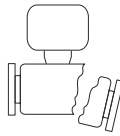

A0013695

A0015502

A0013698



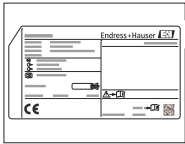
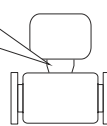

Are the goods undamaged?

   +  

A0015502

A0013699



Do the nameplate data match the ordering information on the delivery note?

   →  + 

A0015502

A0013697

Is the CD-ROM with the Technical Documentation (depends on device version) and documents present?



-  If one of the conditions is not satisfied, contact your Endress+Hauser Sales Center.
- Depending on the device version, the CD-ROM might not be part of the delivery! In such cases, the technical documentation is available via the Internet or via the *Endress+Hauser Operations App*, see the "Product identification" section (→  13).

4.2 Product identification

The following options are available for identification of the measuring device:

- Nameplate specifications
- Order code with breakdown of the device features on the delivery note
- Enter serial numbers from nameplates in *W@M Device Viewer* (www.endress.com/deviceviewer): All information about the measuring device is displayed.
- Enter the serial number from the nameplates into the *Endress+Hauser Operations App* or scan the 2-D matrix code (QR code) on the nameplate with the *Endress+Hauser Operations App*: all the information for the measuring device is displayed.

For an overview of the scope of the associated Technical Documentation, refer to the following:

- The chapters "Additional standard documentation on the device" (→  7) and "Supplementary device-dependent documentation" (→  7)
- The *W@M Device Viewer*: Enter the serial number from the nameplate (www.endress.com/deviceviewer)
- The *Endress+Hauser Operations App*: Enter the serial number from the nameplate or scan the 2-D matrix code (QR code) on the nameplate.

4.2.1 Transmitter nameplate

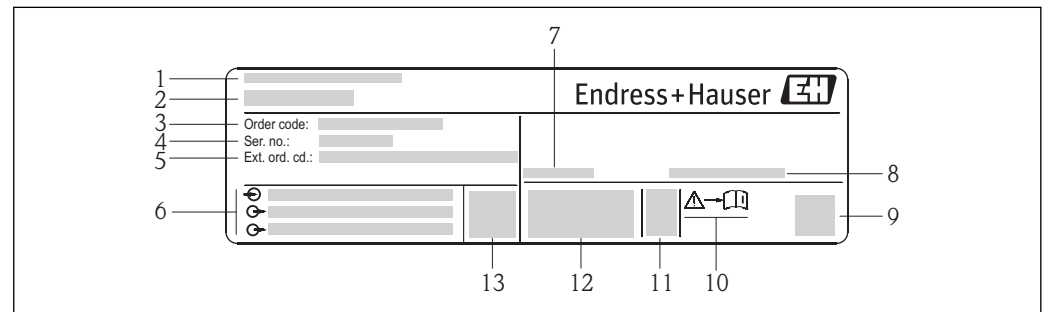

A0017520

 2 Example of a transmitter nameplate

- 1 Manufacturing location
- 2 Name of the transmitter
- 3 Order code
- 4 Serial number
- 5 Extended order code
- 6 Electrical connection data, e.g. available inputs and outputs, supply voltage
- 7 Permitted ambient temperature range (T_a)
- 8 Degree of protection
- 9 2-D matrix code
- 10 Document number of safety-related supplementary documentation (→  77)
- 11 Manufacturing date: year-month
- 12 CE mark, C-Tick
- 13 Firmware version (FW)

4.2.2 Sensor nameplate

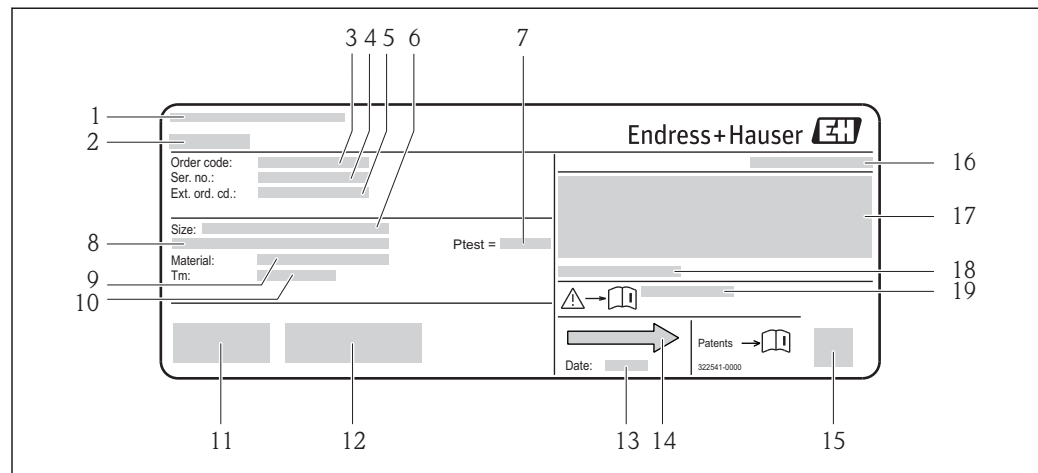

A0013907

3 Example of a sensor nameplate

- 1 Manufacturing location
- 2 Name of the sensor
- 3 Order code
- 4 Serial number (Ser. no.)
- 5 Extended order code (Ext. ord. cd.)
- 6 Nominal diameter of the sensor
- 7 Test pressure of the sensor
- 8 Flange nominal diameter/nominal pressure
- 9 Material of measuring tube and manifold
- 10 Medium temperature range
- 11 CE mark, C-Tick
- 12 Additional information on version: certificates, approvals
- 13 Manufacturing date: year-month
- 14 Flow direction
- 15 2-D matrix code
- 16 Degree of protection
- 17 Approval information for explosion protection and Pressure Equipment Directive
- 18 Permitted ambient temperature (T_a)
- 19 Document number of safety-related supplementary documentation (→ 77)

Order code

The measuring device is reordered using the order code.

Extended order code

- The device type (product root) and basic specifications (mandatory features) are always listed.
- Of the optional specifications (optional features), only the safety and approval-related specifications are listed (e.g. LA). If other optional specifications are also ordered, these are indicated collectively using the # placeholder symbol (e.g. #LA#).
- If the ordered optional specifications do not include any safety and approval-related specifications, they are indicated by the + placeholder symbol (e.g. XXXXXX-ABCDE +).

4.2.3 Promass 100 safety barrier - nameplate

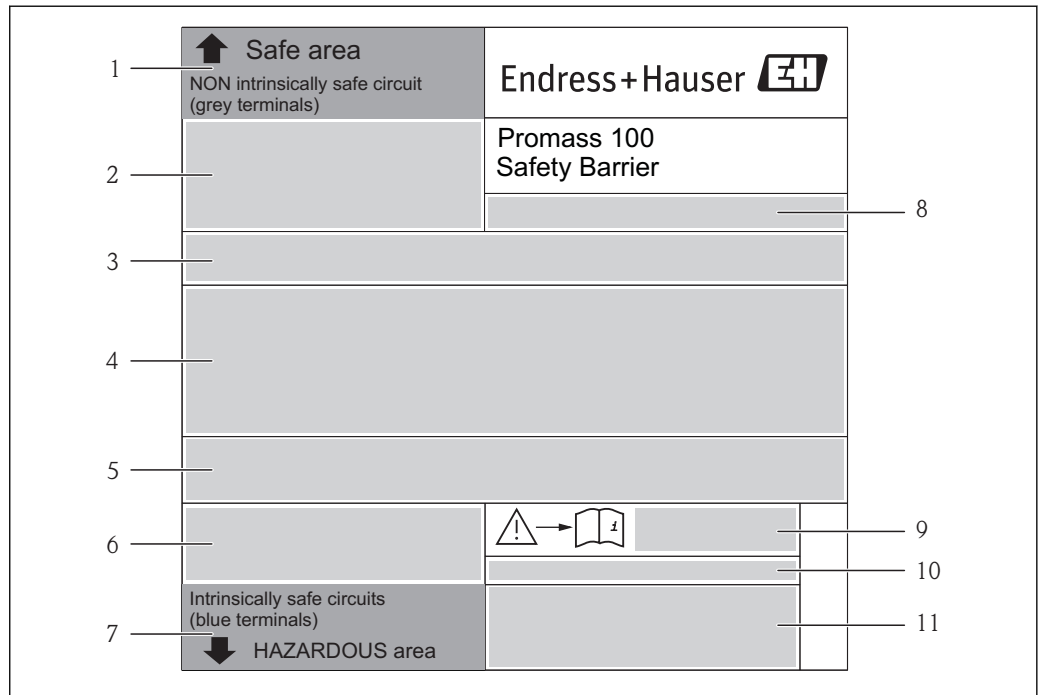



A0017854

4 Example of a Safety Barrier Promass 100 nameplate

- 1 Non-hazardous area or zone 2/div. 2
- 2 Serial number, material number and 2-D matrix code of the Safety Barrier Promass 100
- 3 Electrical connection data, e.g. available inputs and outputs, supply voltage
- 4 Approval information for explosion protection
- 5 Safety warning
- 6 Communication-specific information
- 7 Intrinsically safe area
- 8 Manufacturing location
- 9 Document number of safety-related supplementary documentation (→ 77)
- 10 Permitted ambient temperature (T_a)
- 11 CE mark, C-Tick

4.2.4 Symbols on measuring device

Symbol	Meaning
	WARNING! This symbol alerts you to a dangerous situation. Failure to avoid this situation can result in serious or fatal injury.
 <small>A0011194</small>	Reference to documentation Refers to the corresponding device documentation.
 <small>A0011199</small>	Protective ground connection A terminal which must be connected to ground prior to establishing any other connections.

5 Storage and transport

5.1 Storage conditions

Observe the following notes for storage:

- Store in the original packaging to ensure protection from shock.
- Do not remove protective covers or protective caps installed on process connections. They prevent mechanical damage to the sealing surfaces and fouling in the measuring tube.
- Protect from direct sunlight to avoid unacceptably high surface temperatures.
- Storage temperature: -40 to $+80$ °C (-40 to $+176$ °F), preferable for $+20$ °C ($+68$ °F)
- Store in a dry and dust-free place.
- Do not store outdoors.

5.2 Transporting the product

⚠ WARNING

Center of gravity of the measuring device is higher than the suspension points of the webbing slings.

Risk of injury if the measuring device slips.

- ▶ Secure the measuring device from rotating or slipping.
- ▶ Observe the weight specified on the packaging (stick-on label).
- ▶ Observe the transport instructions on the stick-on label on the electronics compartment cover.

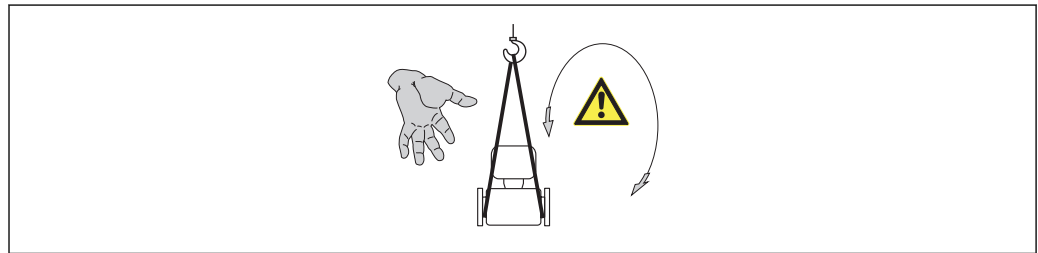

A0015606

Observe the following notes during transport:

- Transport the measuring device to the measuring point in the original packaging.
- Lifting gear
 - Webbing slings: Do not use chains, as they could damage the housing.
 - For wood crates, the floor structure enables these to be loaded lengthwise or broadside using a forklift.
- For measuring device > DN 40 (1½ in): lift the measuring device using the webbing slings at the process connections; do not lift at the transmitter housing.
- Do not remove protective covers or protective caps installed on process connections. They prevent mechanical damage to the sealing surfaces and fouling in the measuring tube.

5.3 Packaging disposal

All packaging materials are environmentally friendly and 100% recyclable:

- Measuring device secondary packaging: polymer stretch film that conforms to EC Directive 2002/95/EC (RoHS).
- Packaging:
 - Wood crate, treated in accordance with ISPM 15 standard, which is confirmed by the affixed IPPC logo.
 - or
 - Carton in accordance with European Packaging Directive 94/62EC; recyclability is confirmed by the affixed RESY symbol.
- Seaworthy packaging (optional): Wood crate, treated in accordance with ISPM 15 standard, which is confirmed by the affixed IPPC logo.
- Carrying and mounting hardware:
 - Disposable plastic pallet
 - Plastic straps
 - Plastic adhesive strips
- Dunnage: Paper cushion

6 Installation

6.1 Installation conditions

No special measures such as supports are necessary. External forces are absorbed by the construction of the device.

6.1.1 Mounting position

Mounting location

To prevent measuring errors arising from accumulation of gas bubbles in the measuring tube, avoid the following mounting locations in the pipe:



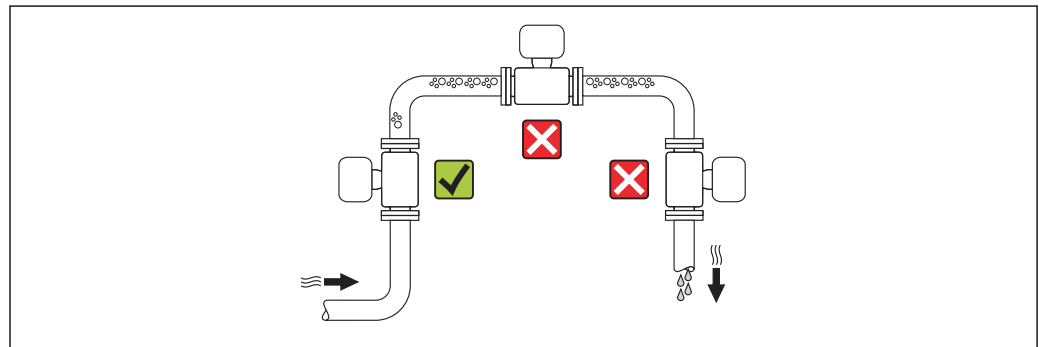



- Highest point of a pipeline.
- Directly upstream of a free pipe outlet in a down pipe.

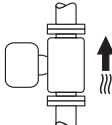
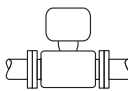

A0015595

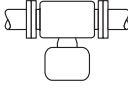
Orientation

The direction of the arrow on the sensor nameplate helps you to install the sensor according to the flow direction (direction of medium flow through the piping).

Orientation		Recommendation
A	Vertical orientation	 A0015591 ✓✓
B	Horizontal orientation, transmitter head up	 A0015589 ✓✓ ¹⁾ Exception: (→  5,  19)
C	Horizontal orientation, transmitter head down	 A0015590 ✓✓ ²⁾ Exception: (→  5,  19)
D	Horizontal orientation, transmitter head at side	 A0015592 ✗

- 1) Applications with low process temperatures may reduce the ambient temperature. To maintain the minimum ambient temperature for the transmitter, this orientation is recommended.
- 2) Applications with high process temperatures may increase the ambient temperature. To maintain the maximum ambient temperature for the transmitter, this orientation is recommended.

If a sensor is installed horizontally with a curved measuring tube, match the position of the sensor to the fluid properties.

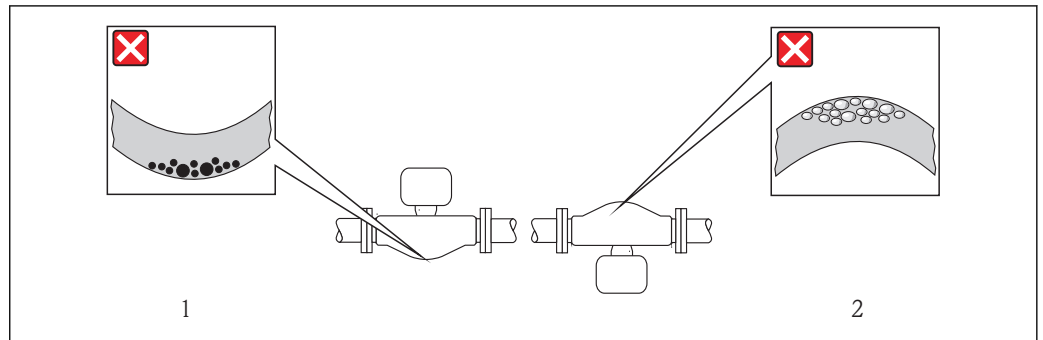

5 Orientation of sensor with curved measuring tube

- 1 Avoid this orientation for fluids with entrained solids: Risk of solids accumulating.
- 2 Avoid this orientation for outgassing fluids: Risk of gas accumulating.

Inlet and outlet runs

No special precautions need to be taken for fittings which create turbulence, such as valves, elbows or T-pieces, as long as no cavitation occurs (→ 19).

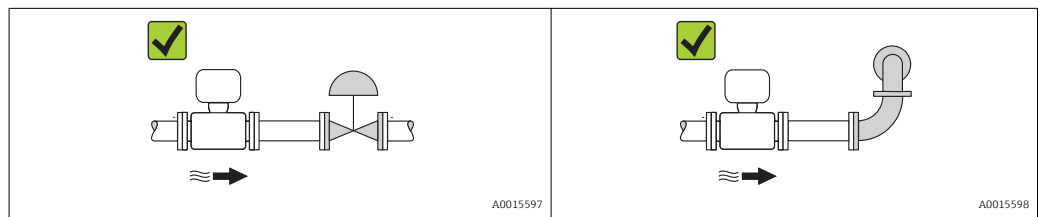

Installation dimensions

For the dimensions and installation lengths of the device, see the "Technical Information" document, "Mechanical construction" section

6.1.2 Requirements from environment and process

Ambient temperature range

Measuring device	-40 to +60 °C (-40 to +140 °F)
Safety Barrier Promass 100	-40 to +60 °C (-40 to +140 °F)

- ▶ If operating outdoors:
Avoid direct sunlight, particularly in warm climatic regions.

System pressure

It is important that cavitation does not occur, or that gases entrained in the liquids do not outgas.

Cavitation is caused if the pressure drops below the vapor pressure:

- In liquids that have a low boiling point (e.g. hydrocarbons, solvents, liquefied gases)
- In suction lines
- ▶ Ensure the system pressure is sufficiently high to prevent cavitation and outgassing.

For this reason, the following mounting locations are recommended:

- At the lowest point in a vertical pipe
- Downstream from pumps (no danger of vacuum)

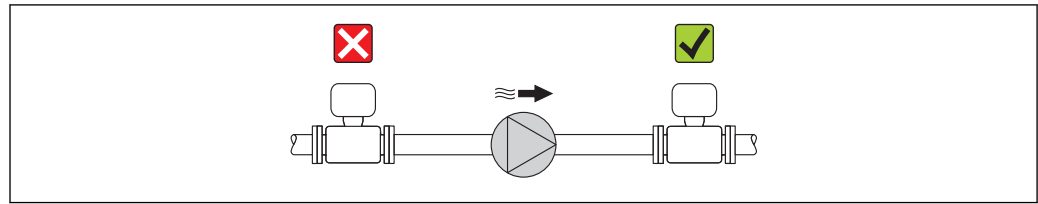

A0015594

Vibrations

The high oscillation frequency of the measuring tubes ensures that the correct operation of the measuring system is not influenced by plant vibrations.

6.1.3 Special mounting instructions

Zero point adjustment

All measuring devices are calibrated in accordance with state-of-the-art technology. Calibration takes place under reference conditions (→ 69). Therefore, a zero point adjustment in the field is generally not required.

Experience shows that zero point adjustment is advisable only in special cases:

- To achieve maximum measuring accuracy even with low flow rates
- Under extreme process or operating conditions (e.g. very high process temperatures or very high-viscosity fluids).

6.2 Mounting the measuring device

6.2.1 Required tools

For sensor

For flanges and other process connections: Corresponding mounting tools

6.2.2 Preparing the measuring device

1. Remove all remaining transport packaging.
2. Remove any protective covers or protective caps present from the sensor.
3. Remove stick-on label on the electronics compartment cover.

6.2.3 Mounting the measuring device

⚠ WARNING

Danger due to improper process sealing!

- ▶ Ensure that the inside diameters of the gaskets are greater than or equal to that of the process connections and piping.
- ▶ Ensure that the gaskets are clean and undamaged.
- ▶ Install the gaskets correctly.

1. Ensure that the direction of the arrow on the nameplate of the sensor matches the flow direction of the fluid.

2. Install the measuring device or turn the transmitter housing so that the cable entries do not point upwards.

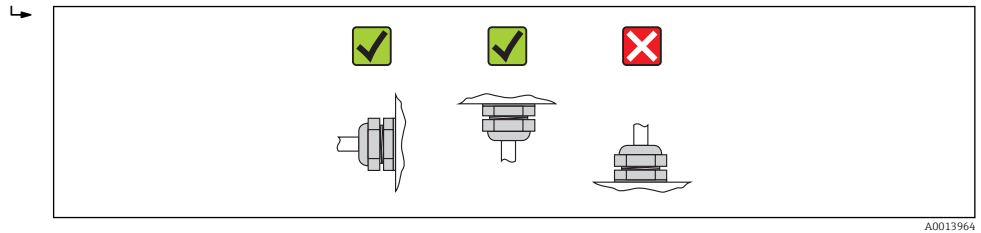

A0013964

6.3 Post-installation check

Is the device undamaged (visual inspection)?	→
Does the measuring device conform to the measuring point specifications? For example: <ul style="list-style-type: none"> ▪ Process temperature (→ 73) ▪ Process pressure (refer to the chapter on "Material load curves" of the "Technical Information" document) ▪ Ambient temperature (→ 19) ▪ Measuring range (→ 66) 	→
Has the correct orientation for the sensor been selected ? <ul style="list-style-type: none"> ▪ According to sensor type ▪ According to medium temperature ▪ According to medium properties (outgassing, with entrained solids) 	→
Does the arrow on the sensor nameplate match the direction of flow of the fluid through the piping (→ 18)?	→
Are the measuring point identification and labeling correct (visual inspection)?	→
Is the device adequately protected from precipitation and direct sunlight?	→
Are the securing screw and securing clamp tightened securely?	→

7 Electrical connection

i The measuring device does not have an internal circuit breaker. For this reason, assign the measuring device a switch or power-circuit breaker so that the power supply line can be easily disconnected from the mains.

7.1 Connection conditions

7.1.1 Required tools

- For cable entries: Use corresponding tools
- For securing clamp (on aluminum housing): Allen screw 3 mm
- For securing screw (for stainless steel housing): open-ended wrench 8 mm
- Wire stripper
- When using stranded cables: crimping tool for ferrule

7.1.2 Requirements for connecting cable

The connecting cables provided by the customer must fulfill the following requirements.

Electrical safety

In accordance with applicable federal/national regulations.

Permitted temperature range

- -40 °C (-40 °F) to $+80\text{ °C}$ ($+176\text{ °F}$)
- Minimum requirement: cable temperature range \geq ambient temperature $+20\text{ K}$

Power supply cable

Standard installation cable is sufficient.

Signal cable

Modbus RS485

The EIA/TIA-485 standard specifies two types of cable (A and B) for the bus line which can be used for every transmission rate. Cable type A is recommended.

Cable type	A
Characteristic impedance	135 to 165 Ω at a measuring frequency of 3 to 20 MHz
Cable capacitance	<30 pF/m
Wire cross-section	>0.34 mm ² (22 AWG)
Cable type	Twisted pairs
Loop resistance	$\leq 110\ \Omega/\text{km}$
Signal damping	Max. 9 dB over the entire length of the cable cross-section
Shielding	Copper braided shielding or braided shielding with foil shield. When grounding the cable shield, observe the grounding concept of the plant.

Connecting cable between Safety Barrier Promass 100 and measuring device

Cable type	Shielded twisted-pair cable with 2x2 wires. When grounding the cable shield, observe the grounding concept of the plant.
Maximum cable resistance	2.5 Ω, one side

- ▶ Comply with the maximum cable resistance specifications to ensure the operational reliability of the measuring device.

The maximum cable length for individual wire cross-sections is specified in the table below. Observe the maximum capacitance and inductance per unit length of the cable and the connection values in the Ex documentation (→  77).

Wire cross-section		Maximum cable length	
[mm ²]	[AWG]	[m]	[ft]
0.5	20	70	230
0.75	18	100	328
1.0	17	100	328
1.5	16	200	656
2.5	14	300	984

Cable diameter

- Cable glands supplied:
M20 × 1.5 with cable ϕ 6 to 12 mm (0.24 to 0.47 in)
- Spring terminals:
Wire cross-sections 0.5 to 2.5 mm² (20 to 14 AWG)
- With Safety Barrier Promass 100:
Plug-in screw terminals for wire cross-sections 0.5 to 2.5 mm² (20 to 14 AWG)

7.1.3 Terminal assignment

Transmitter

Modbus RS485 connection version, for use in intrinsically safe areas

Order code for "Output", option **M** (connection via Safety Barrier Promass 100)

Order code for "Housing"	Connection methods available		Possible options for order code "Electrical connection"
	Output	Power supply	
Options A	Terminals	Terminals	<ul style="list-style-type: none"> ■ Option B: thread M20x1 ■ Option C: thread G ½" ■ Option D: thread NPT ½"
Order code for "Housing": Option A : compact, coated aluminum			

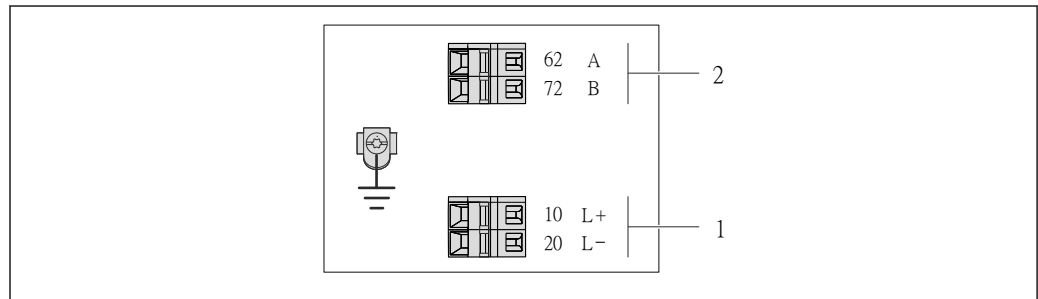

6 *Modbus RS485 terminal assignment, connection version for use in intrinsically safe areas (connection via Safety Barrier Promass 100)*

- 1 *Intrinsically safe power supply*
- 2 *Modbus RS485*

Order code for "Output"	20 (L-)	10 (L+)	72 (B)	62 (A)
Option M	Intrinsically safe supply voltage		Modbus RS485 intrinsically safe	
Order code for "Output": Option M : Modbus RS485, for use in intrinsically safe areas (connection via Safety Barrier Promass 100)				

Safety Barrier Promass 100

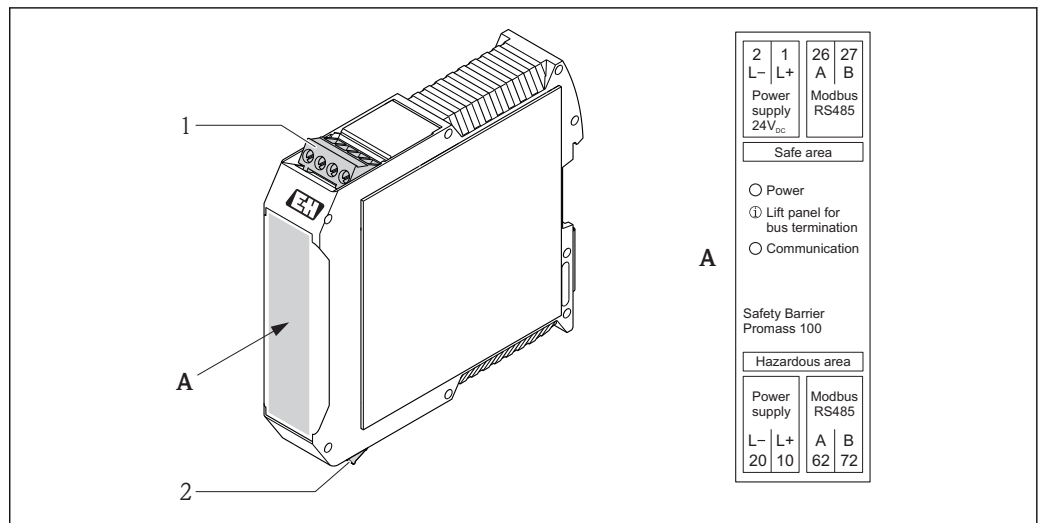

7 Safety Barrier Promass 100 with terminals

- 1 Non-hazardous area and Zone 2/Div. 2
2 Intrinsically safe area

7.1.4 Shielding and grounding

The shielding and grounding concept requires compliance with the following:

- Electromagnetic compatibility (EMC)
- Explosion protection
- Personal protection equipment
- National installation regulations and guidelines
- Observe cable specification (→ 22).
- Keep the stripped and twisted lengths of cable shield to the ground terminal as short as possible.
- Seamless cable shielding.

Grounding of the cable shield

To comply with EMC requirements:

- Ensure the cable shield is grounded to the potential matching line at multiple points.
- Connect every local ground terminal to the potential matching line.

NOTICE

In systems without potential matching, the multiple grounding of the cable shield causes mains frequency equalizing currents!

Damage to the bus cable shield.

- ▶ Only ground the bus cable shield to either the local ground or the protective ground at one end.

7.1.5 Preparing the measuring device

1. Remove dummy plug if present.
2. **NOTICE!** Insufficient sealing of the housing! Operational reliability of the measuring device could be compromised. Use suitable cable glands corresponding to the degree of protection.
If measuring device is delivered without cable glands:
Provide suitable cable gland for corresponding connecting cable (→ 22).
3. If measuring device is delivered with cable glands:
Observe cable specification (→ 22).

7.2 Connecting the measuring device

NOTICE

Limitation of electrical safety due to incorrect connection!

- ▶ Have electrical connection work carried out by correspondingly trained specialists only.
- ▶ Observe applicable federal/national installation codes and regulations.
- ▶ Comply with local workplace safety regulations.
- ▶ For use in potentially explosive atmospheres, observe the information in the device-specific Ex documentation.

7.2.1 Connecting the transmitter

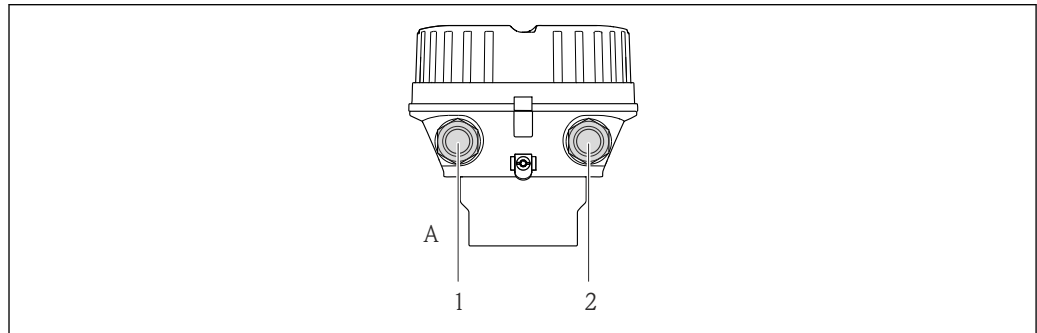

A0019824

8 Device versions and connection versions

- A Housing version: compact, aluminum coated
- 1 Cable entry for signal transmission
- 2 Cable entry for supply voltage

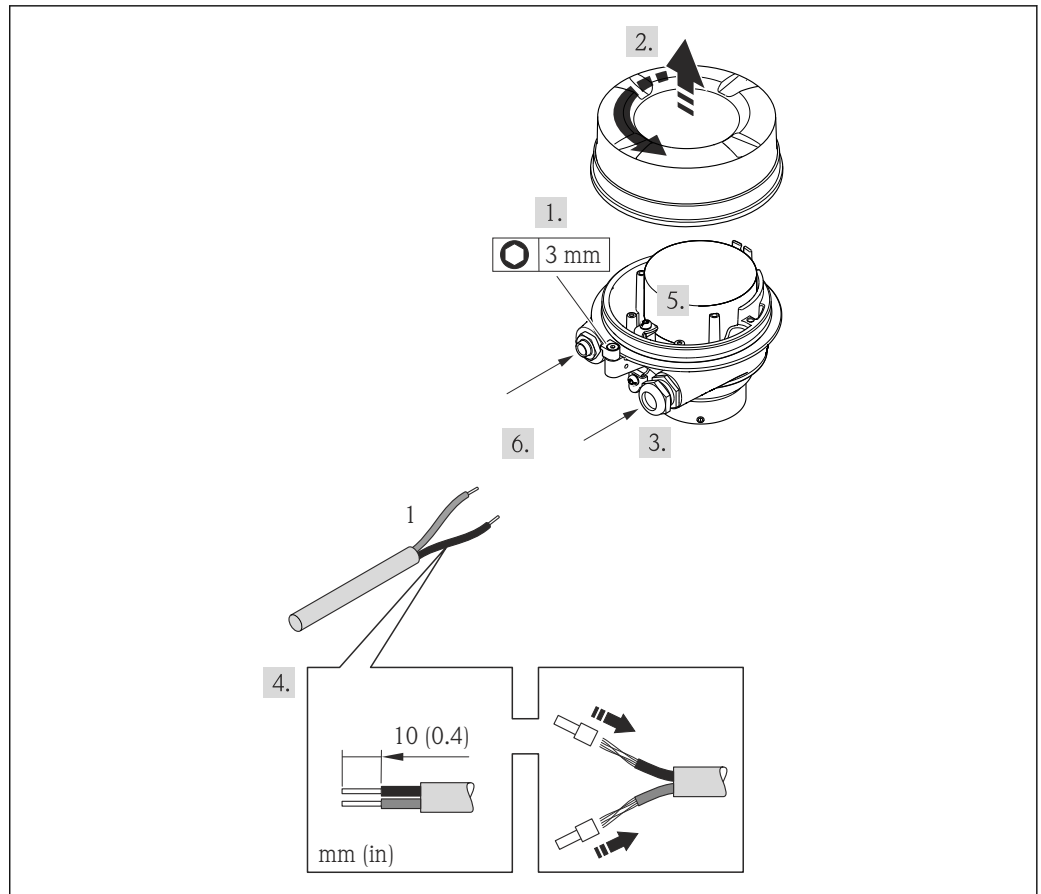

A0021923

9 Device versions with connection example

1 Cable

1. Loosen the securing clamp of the housing cover.
2. Unscrew the housing cover.
3. Push the cable through the cable entry . To ensure tight sealing, do not remove the sealing ring from the cable entry.
4. Strip the cable and cable ends. In the case of stranded cables, also fit ferrules.
5. Connect the cable in accordance with the terminal assignment .
6. Firmly tighten the cable glands. .
7. Enable the terminating resistor if applicable (→ 28).
8. **WARNING!** Housing degree of protection may be voided due to insufficient sealing of the housing. Screw in the screw without using any lubricant. The threads on the cover are coated with a dry lubricant.
Reverse the removal procedure to reassemble the transmitter.

7.2.2 Connecting the Safety Barrier Promass 100

In the case of the device version with Modbus RS485 intrinsically safe, the transmitter must be connected to the Safety Barrier Promass 100.

1. Strip the cable ends. In the case of stranded cables, also fit ferrules.
2. Connect the cable in accordance with the terminal assignment (→ 25).
3. Where applicable, enable the terminating resistor in the Safety Barrier Promass 100 (→ 28).

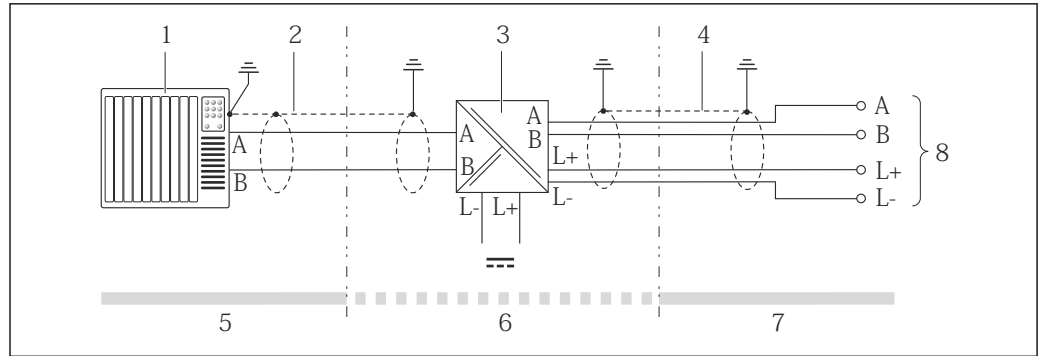

A0016804

10 Electrical connection between the transmitter and Safety Barrier Promass 100

- 1 Control system (e.g. PLC)
- 2 Observe cable specification
- 3 Safety Barrier Promass 100: terminal assignment (→ 25)
- 4 Observe cable specification (→ 22)
- 5 Non-hazardous area
- 6 Non-hazardous area and Zone 2/Div. 2
- 7 Intrinsically safe area
- 8 Transmitter: terminal assignment

7.3 Hardware settings

7.3.1 Enabling the terminating resistor

Modbus RS485

To avoid incorrect communication transmission caused by impedance mismatch, terminate the Modbus RS485 cable correctly at the start and end of the bus segment.

If the transmitter is used in the intrinsically safe area

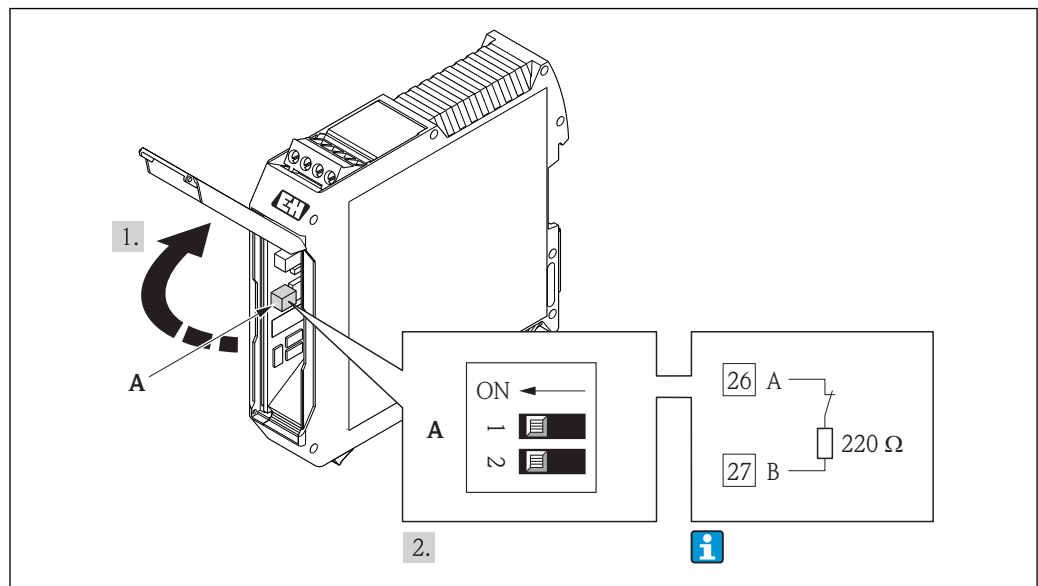

A0017791

11 Terminating resistor can be enabled via DIP switch in the Safety Barrier Promass 100

7.4 Ensuring the degree of protection

The measuring device fulfills all the requirements for the IP66/67 degree of protection, Type 4X enclosure.

To guarantee IP66/67 degree of protection, Type 4X enclosure, carry out the following steps after the electrical connection:

1. Check that the housing seals are clean and fitted correctly. Dry, clean or replace the seals if necessary.
2. Tighten all housing screws and screw covers.
3. Firmly tighten the cable glands.
4. To ensure that moisture does not enter the cable entry, route the cable so that it loops down before the cable entry ("water trap").

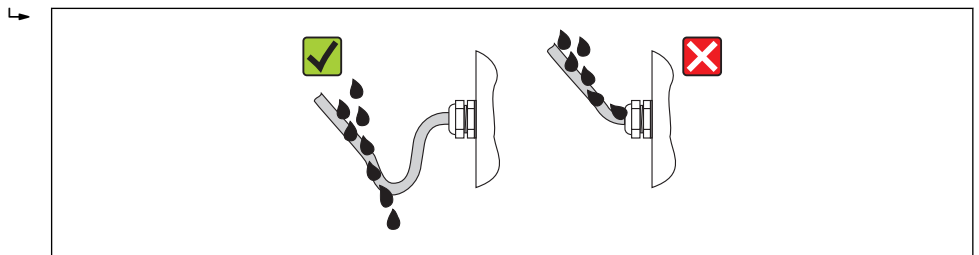

A0013960

5. Insert dummy plugs into unused cable entries.

7.5 Post-connection check

Are cables or the device undamaged (visual inspection)?	<input type="checkbox"/>
Do the cables comply with the requirements (→ 22)?	<input type="checkbox"/>
Do the cables have adequate strain relief?	<input type="checkbox"/>
Are all the cable glands installed, firmly tightened and leak-tight? Cable run with "water trap" (→ 29)?	<input type="checkbox"/>
<ul style="list-style-type: none"> ▪ Does the supply voltage match the specifications on the transmitter nameplate (→ 68)? ▪ For device version with Modbus RS485 intrinsically safe: does the supply voltage match the specifications on the nameplate of the Safety Barrier Promass 100 (→ 68)? 	<input type="checkbox"/>
Is the terminal assignment correct?	<input type="checkbox"/>
<ul style="list-style-type: none"> ▪ If supply voltage is present, is the power LED on the electronics module of the transmitter lit green (→ 11)? ▪ For device version with Modbus RS485 intrinsically safe, if supply voltage is present, is the power LED on the Safety Barrier Promass 100 lit (→ 11)? 	<input type="checkbox"/>
Depending on the device version, is the securing clamp or fixing screw firmly tightened?	<input type="checkbox"/>

8 Operability

8.1 Overview of operation options

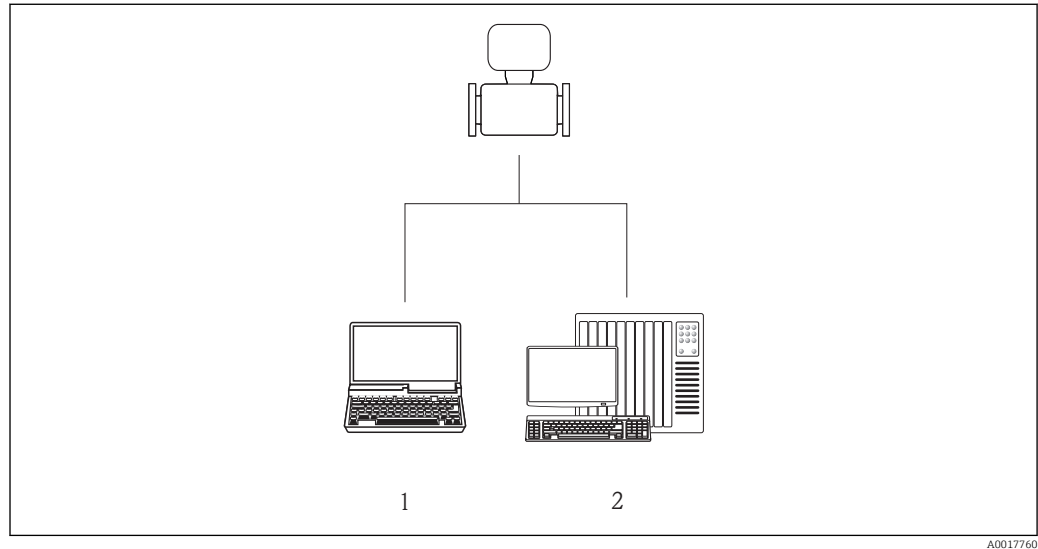



- 1 Computer with Web browser (e.g. Internet Explorer) or with "FieldCare" operating tool via Commubox FXA291 and service interface
- 2 Control system (e.g. PLC)

8.2 Structure and function of the operating menu

8.2.1 Structure of the operating menu

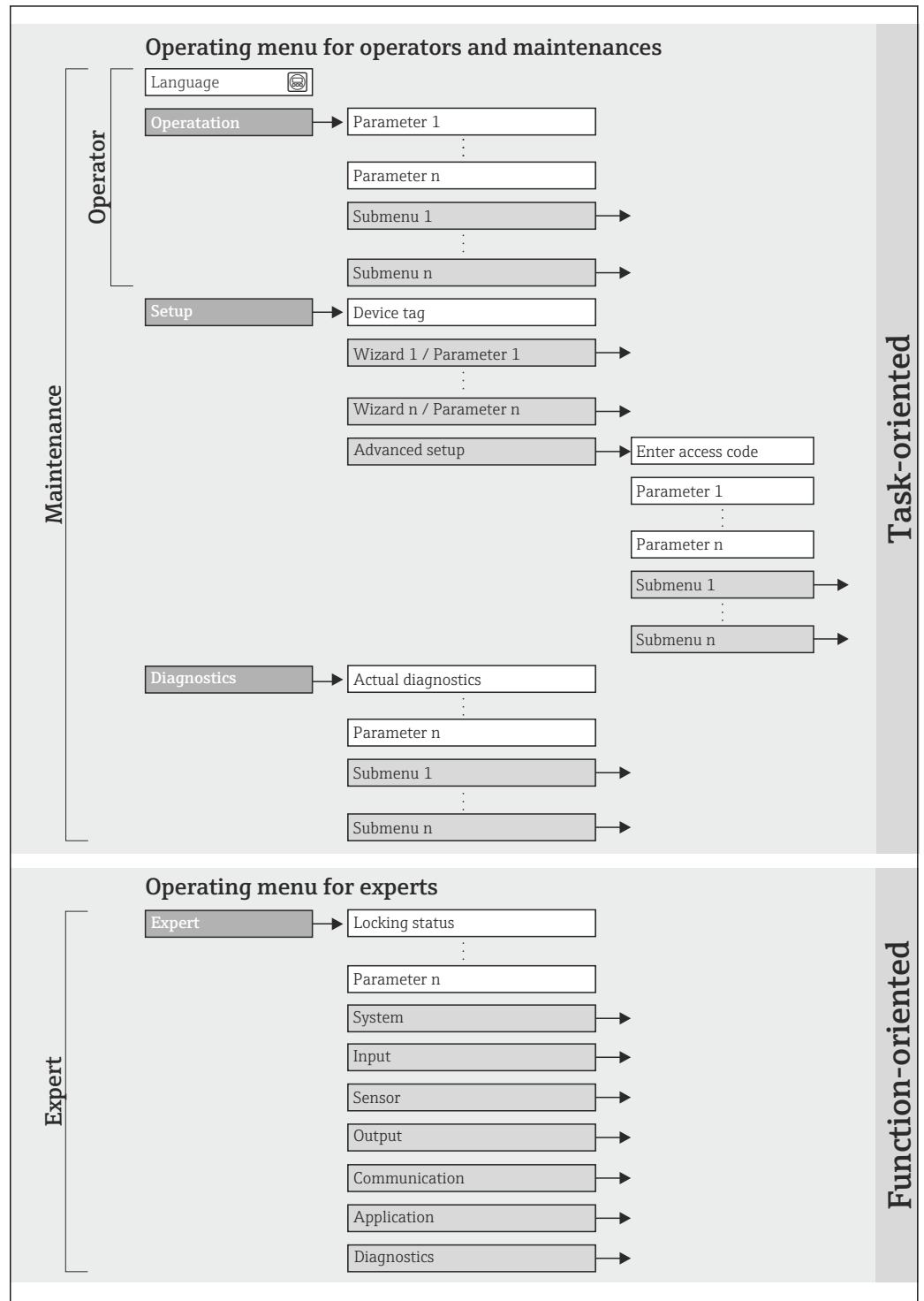
 For an overview of the operating menu with menus and parameters (→  78)



 12 Schematic structure of the operating menu

A0018237-EN

8.2.2 Operating philosophy

The individual parts of the operating menu are assigned to certain user roles. Each user role corresponds to typical tasks within the device lifecycle.

Menu		User role and tasks	Content/meaning
Operation	task-oriented	Role "Operator", "Maintenance" Tasks during operation: Reading measured values	Resetting and controlling totalizers
Setup		"Maintenance" role Commissioning: <ul style="list-style-type: none"> ▪ Configuration of the measurement ▪ Configuration of the communication interface 	Submenus for fast commissioning: <ul style="list-style-type: none"> ▪ Setting the individual system units ▪ Defining the medium ▪ Configuration of the digital communication interface ▪ Configuring the low flow cut off ▪ Configuring the monitoring of partial and empty pipe detection "Advanced setup" submenu: <ul style="list-style-type: none"> ▪ For more customized configuration of the measurement (adaptation to special measuring conditions) ▪ Configuration of totalizers "Device reset" submenu Resets the device configuration to certain settings
Diagnostics		"Maintenance" role Fault elimination: <ul style="list-style-type: none"> ▪ Diagnostics and elimination of process and device errors ▪ Measured value simulation 	Contains all parameters for error detection and analyzing process and device errors: <ul style="list-style-type: none"> ▪ "Diagnostic list" submenu Contains up to 5 currently pending diagnostic messages. ▪ "Event logbook" submenu Contains 20 event messages that have occurred. ▪ "Device information" submenu Contains information for identifying the device. ▪ "Measured values" submenu Contains all current measured values. ▪ "Simulation" submenu Is used to simulate measured values or output values.
Expert	function-oriented	Tasks that require detailed knowledge of the function of the device: <ul style="list-style-type: none"> ▪ Commissioning measurements under difficult conditions ▪ Optimal adaptation of the measurement to difficult conditions ▪ Detailed configuration of the communication interface ▪ Error diagnostics in difficult cases 	Contains all the parameters of the device and makes it possible to access these parameters directly using an access code. The structure of this menu is based on the function blocks of the device: <ul style="list-style-type: none"> ▪ "System" submenu Contains all higher-order device parameters that do not pertain either to measurement or the measured value communication. ▪ "Sensor" submenu Configuration of the measurement. ▪ "Communication" submenu Configuration of the digital communication interface. ▪ "Application" submenu Configuration of the functions that go beyond the actual measurement (e.g. totalizer). ▪ "Diagnostics" submenu Error detection and analysis of process and device errors and for device simulation and Heartbeat Technology.

8.3 Access to the operating menu via the operating tool

8.3.1 Connecting the operating tool

Via service interface (CDI)

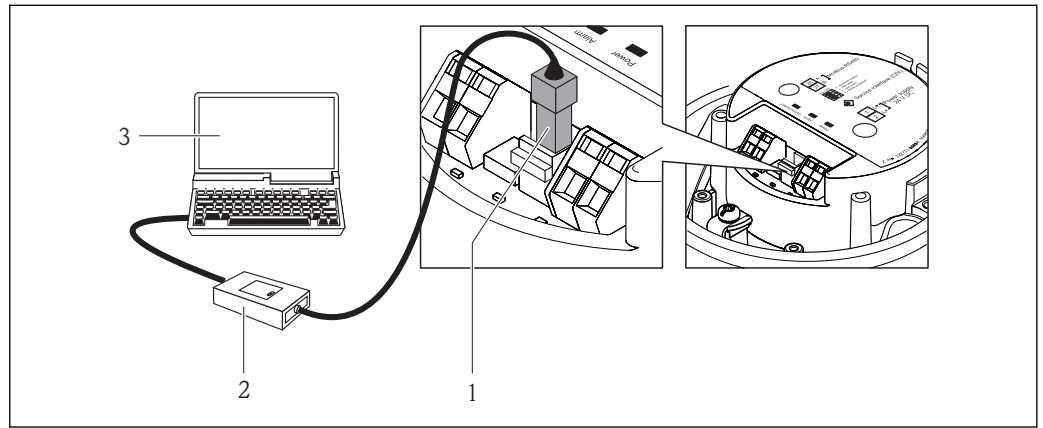

- 1 Service interface (CDI) of the measuring device
 2 Commubox FXA291
 3 Computer with "FieldCare" operating tool with COM DTM "CDI Communication FXA291"

8.3.2 FieldCare

Function scope

FDT-based plant asset management tool from Endress+Hauser. It can configure all smart field devices in a system and helps you manage them. By using the status information, it is also a simple but effective way of checking their status and condition.

Access takes place via:

Service interface CDI (→ 33)

Typical functions:

- Configuring parameters of transmitters
- Loading and saving device data (upload/download)
- Documentation of the measuring point
- Visualization of the measured value memory (line recorder) and event logbook

For details, see Operating Instructions BA00027S and BA00059S

Source for device description files

See data (→ 35)

Establishing a connection

Via service interface (CDI)

1. Start FieldCare and launch the project.
2. In the network: Add a device.
 - ↳ The **Add device** window opens.
3. Select the **CDI Communication FXA291** option from the list and press **OK** to confirm.
4. Right-click **CDI Communication FXA291** and select the **Add device** option in the context menu that opens.



5. Select the desired device from the list and press **OK** to confirm.
6. Establish the online connection to the device.

 For details, see Operating Instructions BA00027S and BA00059S

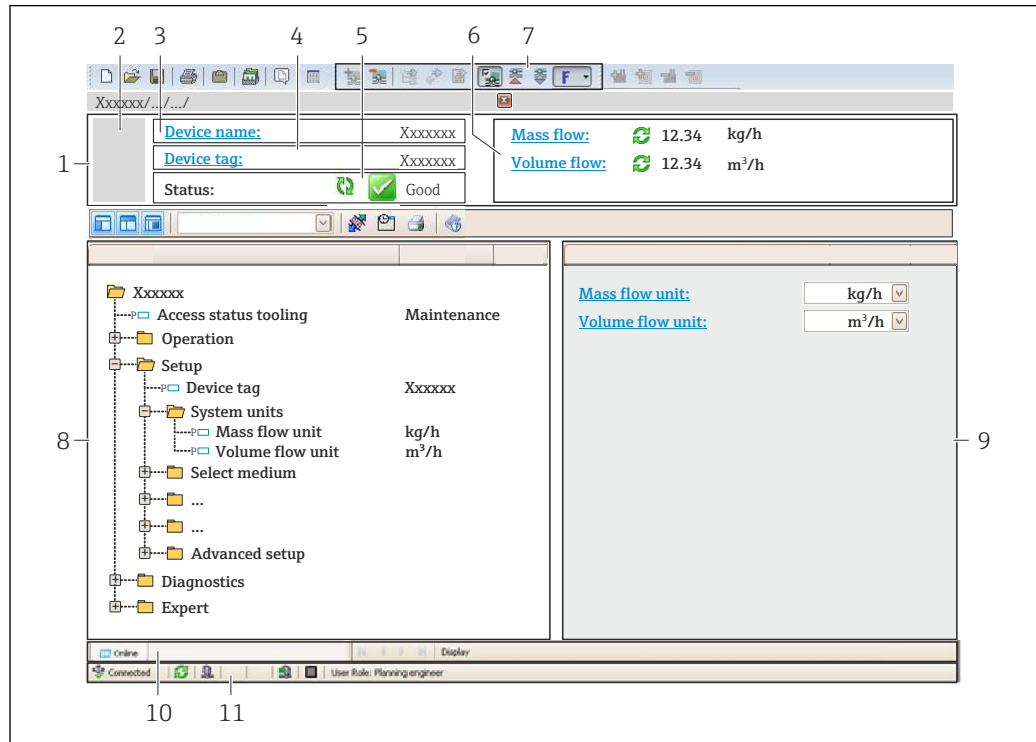
User interface



A0021051-EN

- 1 Header
- 2 Picture of device
- 3 Device name
- 4 Device tag (→  39)
- 5 Status area with status signal (→  54)
- 6 Display area for current measured values (→  49)
- 7 Event list with additional functions such as save/load, events list and document creation
- 8 Navigation area with operating menu structure
- 9 Operating range
- 10 Range of action
- 11 Status area

9 System integration

9.1 Overview of device description files

9.1.1 Current version data for the device

Firmware version	01.02.00	<ul style="list-style-type: none"> ▪ On the title page of the Operating instructions ▪ On transmitter nameplate (→  13) ▪ Parameter firmware version Diagnostics → Device info → Firmware version
Release date of firmware version	04.2013	---

9.1.2 Operating tools



The suitable device description file for the operating tool is listed in the table below, along with information on where the file can be acquired.



Operating tool via service interface (CDI)	Sources for obtaining device descriptions
FieldCare	<ul style="list-style-type: none"> ▪ www.endress.com → Download Area ▪ CD-ROM (contact Endress+Hauser) ▪ DVD (contact Endress+Hauser)

9.2 Modbus RS485 information

9.2.1 Function codes



Function codes are used to define which read or write action is carried out via the Modbus protocol. The measuring device supports the following function codes:

Code	Name	Description	Application
03	Read holding register	<p>Master reads one or more Modbus registers from the device. A maximum of 125 consecutive registers can be read with 1 telegram: 1 register = 2 bytes</p> <p> The measuring device does not make a distinction between function codes 03 and 04; these codes therefore yield the same result.</p>	<p>Read device parameters with read and write access</p> <p>Example: Read mass flow</p>
04	Read input register	<p>Master reads one or more Modbus registers from the device. A maximum of 125 consecutive registers can be read with 1 telegram: 1 register = 2 bytes</p> <p> The measuring device does not make a distinction between function codes 03 and 04; these codes therefore yield the same result.</p>	<p>Read device parameters with read access</p> <p>Example: Read totalizer value</p>

Code	Name	Description	Application
06	Write single registers	Master writes a new value to one Modbus register of the measuring device.  Use function code 16 to write multiple registers with just 1 telegram.	Write only 1 device parameter Example: reset totalizer
08	Diagnostics	Master checks the communication connection to the measuring device. The following "Diagnostics codes" are supported: <ul style="list-style-type: none"> ▪ Sub-function 00 = Return query data (loopback test) ▪ Sub-function 02 = Return diagnostics register 	
16	Write multiple registers	Master writes a new value to multiple Modbus registers of the device. A maximum of 120 consecutive registers can be written with 1 telegram.  If the required device parameters are not available as a group, yet must nevertheless be addressed with a single telegram, use Modbus data map (→  36)	Write multiple device parameters Example: <ul style="list-style-type: none"> ▪ Mass flow unit ▪ Mass unit
23	Read/Write multiple registers	Master reads and writes a maximum of 118 Modbus registers of the measuring device simultaneously with 1 telegram. Write access is executed before read access.	Write and read multiple device parameters Example: <ul style="list-style-type: none"> ▪ Read mass flow ▪ Reset totalizer

 Broadcast messages are only allowed with function codes 06, 16 and 23.

9.2.2 Register information

 For an overview on Modbus-specific information of the individual device parameters, please refer to the additional document on Modbus RS485 register information (→  77)

9.2.3 Response time

Response time of the measuring device to the request telegram of the Modbus master: typically 3 to 5 ms

9.2.4 Modbus data map

Function of the Modbus data map

The device offers a special memory area, the Modbus data map (for a maximum of 16 device parameters), to allow users to call up multiple device parameters via Modbus RS485 and not only individual device parameters or a group of consecutive device parameters.

Grouping of device parameters is flexible and the Modbus master can read or write to the entire data block simultaneously with a single request telegram.

Structure of the Modbus data map

The Modbus data map consists of two data sets:

- **Scan list: Configuration area**
The device parameters to be grouped are defined in a list in that their Modbus RS485 register addresses are entered in the list.
- **Data area**
The measuring device reads out the register addresses entered in the scan list cyclically and writes the associated device data (values) to the data area.

 For an overview of device parameters with their individual Modbus register address, please refer to the additional document on Modbus RS485 register information (→  77)

Scan list configuration

For configuration, the Modbus RS485 register addresses of the device parameters to be grouped must be entered in the scan list. Please note the following basic requirements of the scan list:

Max. entries	16 device parameters
Supported device parameters	Only parameters with the following characteristics are supported: <ul style="list-style-type: none"> ■ Access type: read or write access ■ Data type: float or integer

Configuring the scan list via FieldCare

Carried out using the operating menu of the measuring device:

Expert → Communication → Modbus data map → Scan list register 0 -15

Scan list	
No.	Configuration register
0	Scan list register 0
...	...
15	Scan list register 15

Configuring the scan list via Modbus RS485

Carried out using register addresses 5001 - 5016

Scan list			
No.	Modbus RS485 register	Data type	Configuration register
0	5001	Integer	Scan list register 0
...	...	Integer	...
15	5016	Integer	Scan list register 15

Reading out data via Modbus RS485

The Modbus master accesses the data area of the Modbus data map to read out the current values of the device parameters defined in the scan list.



Master access to data area	Via register addresses 5051-5081
-----------------------------------	----------------------------------

Data area			
Device parameter value	Modbus RS485 register	Data type*	Access**
Value of scan list register 0	5051	Integer/float	Read/write
Value of scan list register 1	5053	Integer/float	Read/write
Value of scan list register
Value of scan list register 15	5081	Integer/float	Read/write
* Data type depends on the device parameters entered in the scan list. ** Data access depends on the device parameters entered in the scan list. If the device parameter entered supports read and write access, the parameter can also be accessed via the data area.			



10 Commissioning

10.1 Function check

Before commissioning the device, make sure that the post-installation and post-connection checks have been performed.

- "Post-installation check" checklist (→  21)
- "Post-connection check" checklist (→  29)

10.2 Establishing a connection via FieldCare

- For FieldCare connection (→  33)
- For establishing a connection via FieldCare (→  33)
- For FieldCare user interface (→  34)

10.3 Configuring the measuring device

The **Setup** menu with its submenus contains all the parameters needed for standard operation.

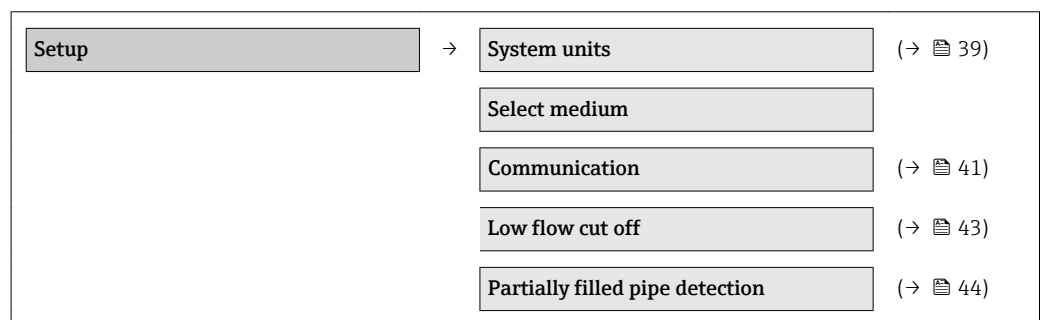

Structure of the "Setup" menu



10.3.1 Defining the tag name

To enable fast identification of the measuring point within the system, you can enter a unique designation using the **Device tag** parameter and thus change the factory setting.

 The number of characters displayed depends on the characters used.

 For information on the tag name in the "FieldCare" operating tool (→  34)

10.3.2 Setting the system units

In the **System units** submenu the units of all the measured values can be set.

Structure of the submenu

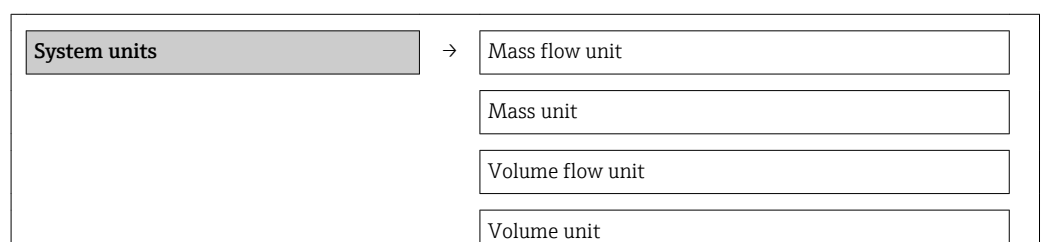

Corrected volume flow unit
Corrected volume unit
Density unit
Reference density unit
Temperature unit
Pressure unit

Parameter overview with brief description

Parameter	Description	Selection	Factory setting
Mass flow unit	Select mass flow unit. <i>Result</i> The selected unit applies for: <ul style="list-style-type: none"> ▪ Output ▪ Low flow cut off ▪ Simulation process variable 	Unit choose list	Country-specific: <ul style="list-style-type: none"> ▪ kg/h ▪ lb/min
Mass unit	Select mass unit. <i>Result</i> The selected unit is taken from: Mass flow unit parameter	Unit choose list	Country-specific: <ul style="list-style-type: none"> ▪ kg ▪ lb
Volume flow unit	Select volume flow unit. <i>Result</i> The selected unit applies for: <ul style="list-style-type: none"> ▪ Output ▪ Low flow cut off ▪ Simulation process variable 	Unit choose list	Country-specific: <ul style="list-style-type: none"> ▪ l/h ▪ gal/min (us)
Volume unit	Select volume unit. Result The selected unit is taken from: Volume flow unit parameter	Unit choose list	Country-specific: <ul style="list-style-type: none"> ▪ l ▪ gal (us)
Corrected volume flow unit	Select corrected volume flow unit. <i>Result</i> The selected unit applies for: <ul style="list-style-type: none"> ▪ Output ▪ Low flow cut off ▪ Simulation process variable 	Unit choose list	Country-specific: <ul style="list-style-type: none"> ▪ NI/h ▪ Sft³/h
Corrected volume unit	Select corrected volume unit. Result The selected unit is taken from: Corrected volume flow unit parameter	Unit choose list	Country-specific: <ul style="list-style-type: none"> ▪ NI ▪ Sft³
Density unit	Select density unit. <i>Result</i> The selected unit applies for: <ul style="list-style-type: none"> ▪ Output ▪ Simulation process variable ▪ Density adjustment (in Expert menu) 	Unit choose list	Country-specific: <ul style="list-style-type: none"> ▪ kg/l ▪ lb/ft³
Reference density unit	Select reference density unit.	Unit choose list	kg/NI

Parameter	Description	Selection	Factory setting
Temperature unit	Select temperature unit. <i>Result</i> The selected unit applies for: <ul style="list-style-type: none"> ▪ Output ▪ Reference temperature ▪ Simulation process variable 	Unit choose list	Country-specific: <ul style="list-style-type: none"> ▪ °C (Celsius) ▪ °F (Fahrenheit)
Pressure unit	Select process pressure unit.	Unit choose list	Country-specific: <ul style="list-style-type: none"> ▪ bar ▪ psi

10.3.3 Configuring the communication interface

The "**Communication**" submenu guides you systematically through all the parameters that have to be configured for selecting and setting the communication interface.

Navigation

"Setup" menu → Communication

Structure of the submenu

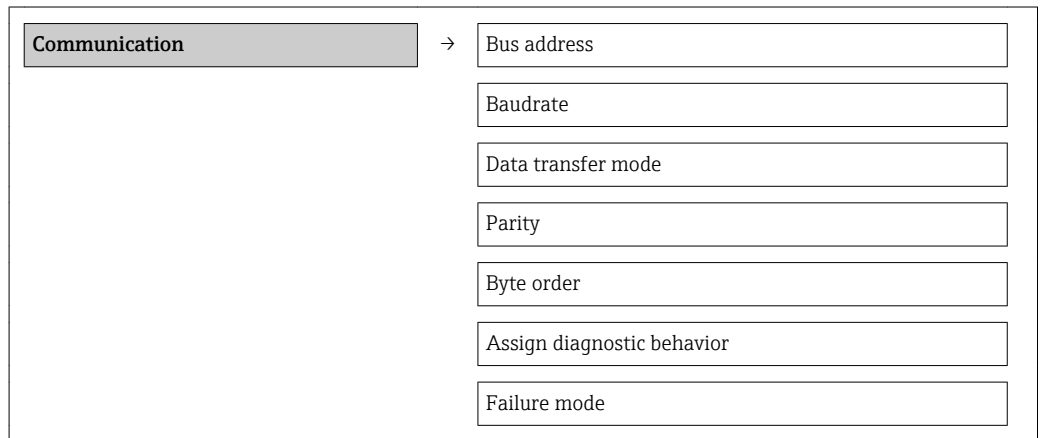

Parameter overview with brief description

Parameter	Description	User entry / Selection	Factory setting
Bus address	Enter device address.	1 to 247	247
Baudrate	Define data transfer speed.	<ul style="list-style-type: none"> ▪ 1200 BAUD ▪ 2400 BAUD ▪ 4800 BAUD ▪ 9600 BAUD ▪ 19200 BAUD ▪ 38400 BAUD ▪ 57600 BAUD ▪ 115200 BAUD 	19200 BAUD
Data transfer mode	Select data transfer mode.	<ul style="list-style-type: none"> ▪ ASCII ▪ RTU 	RTU
Parity	Select parity bits.	<ul style="list-style-type: none"> ▪ Odd ▪ Even ▪ None / 1 stop bit ▪ None / 2 stop bits 	Even
Byte order	Select byte transmission sequence.	<ul style="list-style-type: none"> ▪ 0-1-2-3 ▪ 3-2-1-0 ▪ 1-0-3-2 ▪ 2-3-0-1 	1-0-3-2

Parameter	Description	User entry / Selection	Factory setting
Assign diagnostic behavior	Select diagnostic behavior for MODBUS communication.	<ul style="list-style-type: none">▪ Off▪ Alarm or warning▪ Warning▪ Alarm	Alarm
Failure mode	Select measured value output behavior when a diagnostic message occurs via Modbus communication.	<ul style="list-style-type: none">▪ NaN value▪ Last valid value	NaN value

10.3.4 Configuring the low flow cut off

The **Low flow cut off** submenu contains parameters that must be configured for the configuration of low flow cut off.

Navigation

"Setup" menu → Low flow cut off

Low flow cut off	→	Assign process variable
		On value low flow cutoff
		Off value low flow cutoff
		Pressure shock suppression

Parameter overview with brief description

Parameter	Prerequisite	Description	Selection / User entry	Factory setting
Assign process variable	–	Select process variable for low flow cut off.	<ul style="list-style-type: none"> ■ Off ■ Mass flow ■ Volume flow ■ Corrected volume flow 	Mass flow
On value low flow cutoff	One of the following options is selected in the Assign process variable parameter: <ul style="list-style-type: none"> ■ Mass flow ■ Volume flow ■ Corrected volume flow 	Enter on value for low flow cut off.	Positive floating-point number	For liquids: depends on country and nominal diameter
Off value low flow cutoff	One of the following options is selected in the Assign process variable parameter: <ul style="list-style-type: none"> ■ Mass flow ■ Volume flow ■ Corrected volume flow 	Enter off value for low flow cut off.	0 to 100.0 %	50 %
Pressure shock suppression	One of the following options is selected in the Assign process variable parameter: <ul style="list-style-type: none"> ■ Mass flow ■ Volume flow ■ Corrected volume flow 	Enter time frame for signal suppression (= active pressure shock suppression).	0 to 100 s	0 s

10.3.5 Configuring the partial filled pipe detection

The **Partially filled pipe detection** submenu contains parameters that have to be set for configuring empty pipe detection.

Navigation

"Setup" menu → Partially filled pipe detection

Partially filled pipe detection	→	Assign process variable
		Low value partial filled pipe detection
		High value partial filled pipe detection
		Response time part. filled pipe detect.

Parameter overview with brief description

Parameter	Prerequisite	Description	Selection / User entry	Factory setting
Assign process variable	–	Select process variable for partially filled pipe detection.	<ul style="list-style-type: none"> ■ Off ■ Density ■ Reference density 	Off
Low value partial filled pipe detection	One of the following options is selected in the Assign process variable parameter: <ul style="list-style-type: none"> ■ Density ■ Reference density 	Enter lower limit value for deactivating partially filled pipe detection.	Signed floating-point number	Country-dependent: <ul style="list-style-type: none"> ■ 0.2 kg/l ■ 12.5 lb/ft³
High value partial filled pipe detection	One of the following options is selected in the Assign process variable parameter: <ul style="list-style-type: none"> ■ Density ■ Reference density 	Enter upper limit value for deactivating partially filled pipe detection.	Signed floating-point number	Country-dependent: <ul style="list-style-type: none"> ■ 6 kg/l ■ 374.6 lb/ft³
Response time part. filled pipe detect.	One of the following options is selected in the Assign process variable parameter: <ul style="list-style-type: none"> ■ Density ■ Reference density 	Enter time before diagnostic message is displayed for partially filled pipe detection.	0 to 100 s	1 s

10.4 Advanced settings

The **Advanced setup** submenu with its submenus contains parameters for specific settings.

"Setup" menu → Advanced setup

Overview of the parameters and submenus in the "Advanced setup" menu taking the example of the Web browser

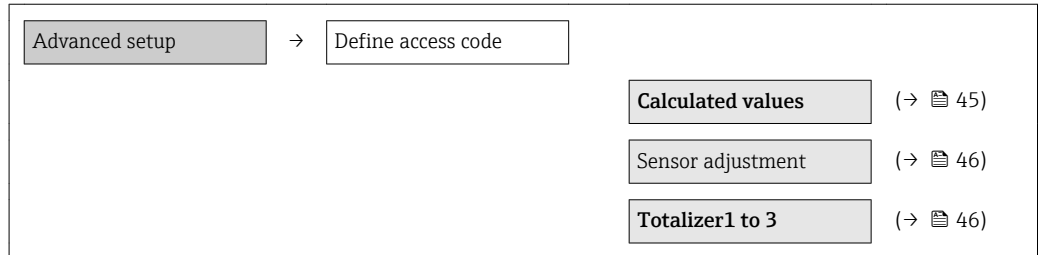

10.4.1 Calculated values

The **Calculated values** submenu contains parameters for calculating the corrected volume flow.

Navigation

"Setup" menu → Advanced setup → Calculated values

Structure of the submenu

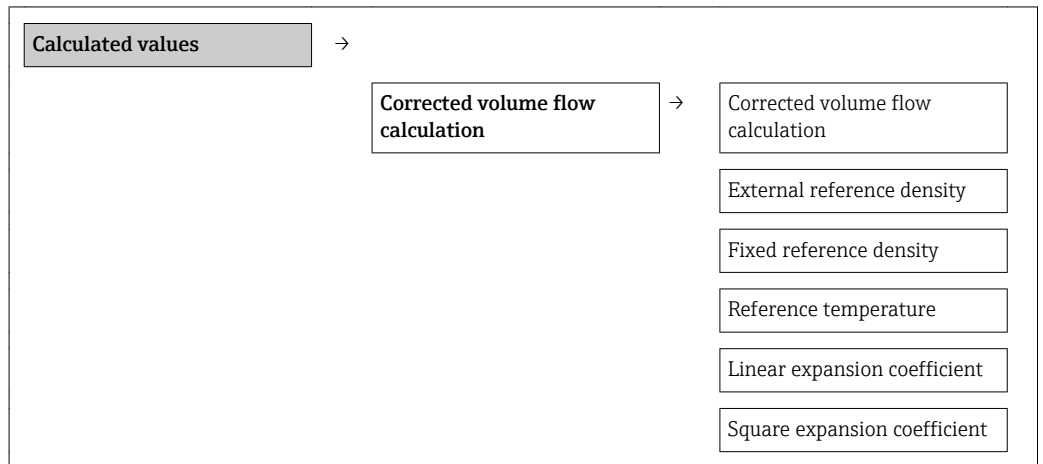

Parameter overview with brief description

Parameter	Prerequisite	Description	Selection / User entry	Factory setting
Corrected volume flow calculation	–	Select reference density for calculating the corrected volume flow.	<ul style="list-style-type: none"> ■ Fixed reference density ■ Calculated reference density ■ Reference density by API table 53 ■ External reference density 	Calculated reference density
External reference density	–	Shows external reference density.	Floating point number with sign	0 kg/Nl

Parameter	Prerequisite	Description	Selection / User entry	Factory setting
Fixed reference density	The following option is selected in the Corrected volume flow calculation parameter: Fixed reference density	Enter fixed value for reference density.	Positive floating-point number	0.001 kg/Nl
Reference temperature	The following option is selected in the Corrected volume flow calculation parameter: Calculated reference density	Enter reference temperature for calculating the reference density.	-273.15 to 99 999 °C	20 °C
Linear expansion coefficient	The following option is selected in the Corrected volume flow calculation parameter: Calculated reference density	Enter linear, medium-specific expansion coefficient for calculating the reference density.	Signed floating-point number	0.0
Square expansion coefficient	–	For media with a non-linear expansion pattern: enter the quadratic, medium-specific expansion coefficient for calculating the reference density.	Signed floating-point number	0.0

10.4.2 Carrying out a sensor adjustment

The **Sensor adjustment** submenu contains parameters that pertain to the functionality of the sensor.

Navigation

"Setup" menu → Advanced setup → Sensor adjustment

Structure of the submenu

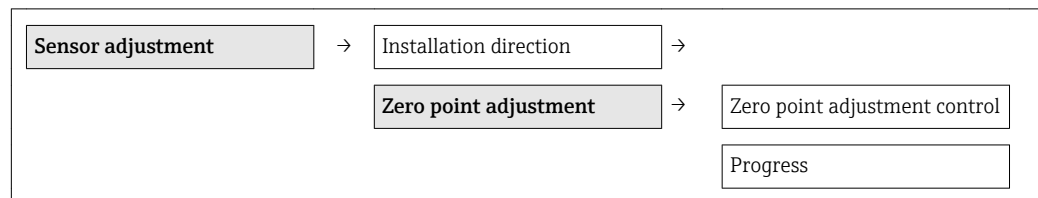

Parameter overview with brief description

Parameter	Description	Selection / User interface	Factory setting
Installation direction	Set sign of flow direction to match the direction of the arrow on the sensor.	<ul style="list-style-type: none"> ■ Flow in arrow direction ■ Flow against arrow direction 	Flow in arrow direction
Zero point adjustment control	Start zero point adjustment.	<ul style="list-style-type: none"> ■ Cancel ■ Busy ■ Zero point adjust failure ■ Start 	Cancel
Progress	Shows the progress of the process.	0 to 100 %	0 %

10.4.3 Configuring the totalizer

In the **"Totalizer 1 to 3"** submenu the individual totalizers can be configured.

Navigation

"Setup" menu → Advanced setup → Totalizer 1 to 3

10.5 Simulation

The "**Simulation**" submenu enables you to simulate, without a real flow situation, various process variables in the process and the device alarm mode and to verify downstream signal chains (switching valves or closed-control loops).

Navigation

"Diagnostics" menu → Simulation

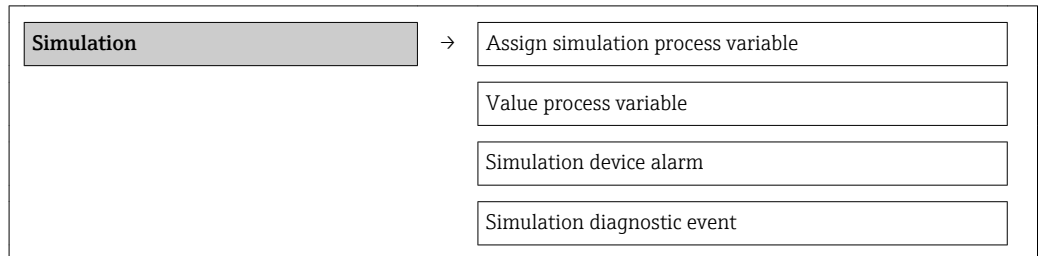

Parameter overview with brief description

Parameter	Prerequisite	Description	Selection / User entry	Factory setting
Assign simulation process variable	–	Select a process variable for the simulation process that is activated.	<ul style="list-style-type: none"> ▪ Off ▪ Mass flow ▪ Volume flow ▪ Corrected volume flow ▪ Density ▪ Reference density ▪ Temperature ▪ Dynamic viscosity ▪ Kinematic viscosity ▪ Temp. compensated dynamic viscosity ▪ Temp. compensated kinematic viscosity ▪ Concentration ▪ Target mass flow ▪ Carrier mass flow 	Off
Value process variable	A process variable is selected in the Assign simulation process variable parameter.	Enter the simulation value for the selected process variable.	Signed floating-point number	0
Simulation device alarm	–	Switch the device alarm on and off.	<ul style="list-style-type: none"> ▪ Off ▪ On 	Off
Simulation diagnostic event	–	Enter the diagnostic number for the diagnostic event.	Positive integer	65 533

10.6 Protecting settings from unauthorized access

The following option exists for protecting the configuration of the measuring device from unintentional modification after commissioning: Write protection via write protection switch

10.6.1 Write protection via write protection switch

The write protection switch makes it possible to block write access to the entire operating menu with the exception of the following parameters:

- External pressure
- External temperature
- Reference density
- All parameters for configuring the totalizer

The parameter values are now read only and cannot be edited any more:

- Via service interface (CDI)
- Via Modbus RS485

For device version with Modbus RS485 communication types

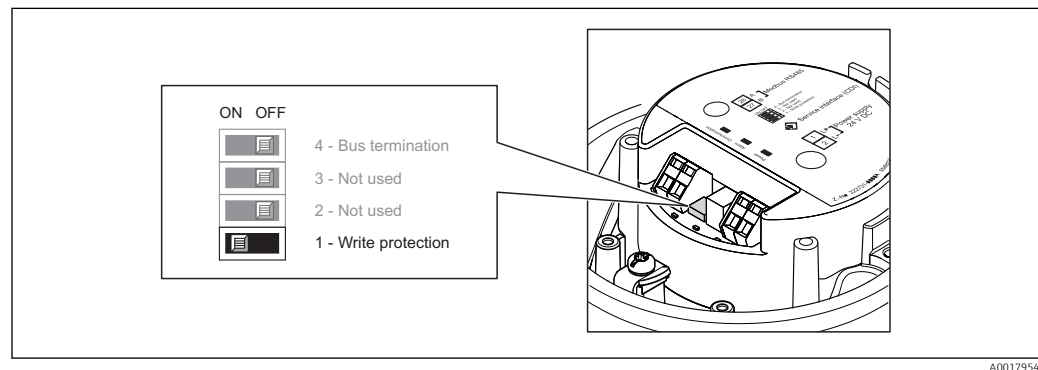

1. Depending on the housing version, loosen the securing clamp or fixing screw of the housing cover.
2. Depending on the housing version, unscrew or open the housing cover.
3. Setting the write protection switch on the main electronics module to the ON position enables the hardware write protection. Setting the write protection switch on the main electronics module to the OFF position (factory setting) disables the hardware write protection.
 - ↳ If hardware write protection is enabled: the **Locking status** parameter displays the **Hardware locked** option (→ 49); if disabled, the **Locking status** parameter does not display any option (→ 49)
4. Reverse the removal procedure to reassemble the transmitter.

11 Operation

11.1 Reading device locking status

The write protection types that are currently active can be determined using the **Locking status** parameter.

Navigation

"Operation" menu → Locking status

Function scope of "Locking status" parameter

Options	Description
Hardware locked	The locking switch (DIPswitch) for locking the hardware is activated on the main electronic module. This prevents write access to the parameters (→ 48).
Temporarily locked	Due to internal processing in the device (e.g. up-/downloading of data, reset), write access to the parameters is blocked for a short time. Once the internal processing has been completed, the parameters can be changed once again.

11.2 Reading measured values

Using the **Measured values** submenu, it is possible to read all the measured values.

"Diagnostics" menu → Measured values

11.2.1 Process variables

The **Process variables** submenu contains all the parameters needed to display the current measured values for every process variable.

Navigation

"Diagnostics" menu → Measured values → Process variables

Process variables	Mass flow
	Volume flow
	Corrected volume flow
	Density
	Reference density
	Temperature
	Pressure value

Parameter overview with brief description

Parameter	Description	User interface
Mass flow	Displays the volume flow currently measured.	Signed floating-point number
Volume flow	Displays the mass flow currently calculated.	Signed floating-point number
Corrected volume flow	Displays the temperature currently measured.	Signed floating-point number
Density	Displays the corrected volume flow currently calculated.	Signed floating-point number
Reference density	Displays the saturated steam pressure currently calculated.	Signed floating-point number

Parameter	Description	User interface
Temperature	Displays the steam quality currently calculated.	Signed floating-point number
Pressure value	Displays either a fixed or external pressure value.	Signed floating-point number

11.2.2 Totalizer

The **"Totalizer"** submenu contains all the parameters needed to display the current measured values for every totalizer.

Navigation

"Diagnostics" menu → Measured values → Totalizer

Structure of the submenu

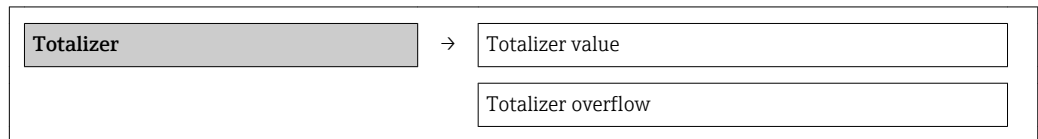

Parameter overview with brief description

Parameter	Prerequisite	Description	User interface	Factory setting
Totalizer value	In the Assign process variable parameter of the Totalizer 1 to 3 submenu one of the following options is selected: <ul style="list-style-type: none"> ▪ Volume flow ▪ Corrected volume flow ▪ Mass flow ▪ Total mass flow ▪ Condensate mass flow ▪ Energy flow ▪ Heat flow difference 	Displays the current totalizer counter value.	Signed floating-point number	0 kg
Totalizer overflow	In the Assign process variable parameter of the Totalizer 1 to 3 submenu one of the following options is selected: <ul style="list-style-type: none"> ▪ Volume flow ▪ Corrected volume flow ▪ Mass flow ▪ Total mass flow ▪ Condensate mass flow ▪ Energy flow ▪ Heat flow difference 	Displays the current totalizer overflow.	-32 000.0 to 32 000.0	0

11.3 Adapting the measuring device to the process conditions

The following are available for this purpose:

- Basic settings using the **Setup** menu(→ 39)
- Advanced settings using the **Advanced setup** submenu(→ 45)

11.4 Performing a totalizer reset

In the **Operation** submenu the totalizers are reset:

- Control Totalizer
- Reset all totalizers

Function scope of "Control Totalizer" parameter

Options	Description
Totalize	The totalizer is started.
Reset + hold	The totaling process is stopped and the totalizer is reset to 0.
Preset + hold	The totaling process is stopped and the totalizer is set to its defined start value from the Preset value parameter.
Reset + totalize	The totalizer is reset to 0 and the totaling process is restarted.
Preset + totalize	The totalizer is set to the defined start value in Preset value parameter and the totaling process is restarted.

Function scope of "Reset all totalizers" parameter

Options	Description
Reset + totalize	Resets all totalizers to 0 and restarts the totaling process. This deletes all the flow values previously totalized.

Navigation

"Operation" menu → Operation

Structure of the submenu

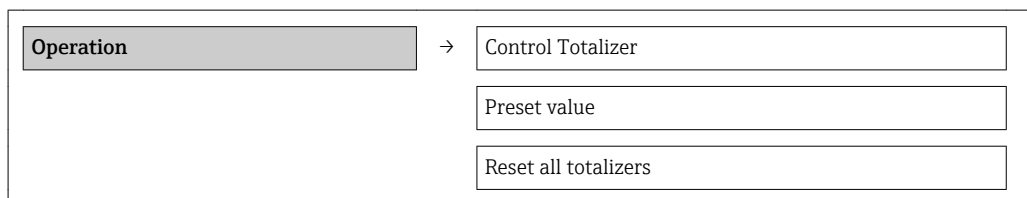



Parameter overview with brief description

Parameter	Description	Selection / User entry	Factory setting
Control Totalizer	Control totalizer value.	<ul style="list-style-type: none"> ■ Totalize ■ Reset + hold ■ Preset + hold ■ Reset + totalize ■ Preset + totalize 	Totalize
Preset value	Specify start value for totalizer.	Signed floating-point number	0 kg
Reset all totalizers	Reset all totalizers to 0 and start.	<ul style="list-style-type: none"> ■ Cancel ■ Reset + totalize 	Cancel





12 Diagnostics and troubleshooting

12.1 General troubleshooting

For output signals

Problem	Possible causes	Remedy
Green power LED on the main electronics module of the transmitter is dark	Supply voltage does not match that specified on the nameplate.	Apply the correct supply voltage (→  26).
Green power LED on the main electronics module of the transmitter is dark	Power supply cable connected incorrectly	Check the terminal assignment .
Green power LED on Safety Barrier Promass 100 is dark	Supply voltage does not match that specified on the nameplate.	Apply the correct supply voltage (→  26).
Green power LED on Safety Barrier Promass 100 is dark	Power supply cable connected incorrectly	Check the terminal assignment (→  25).
Device measures incorrectly.	Configuration error or device is operated outside the application.	1. Check and correct parameter configuration. 2. Observe limit values specified in the "Technical Data".

For access

Problem	Possible causes	Remedy
No write access to parameters	Hardware write protection enabled	Set the write protection switch on the main electronics module to the OFF position (→  48).
No connection via Modbus RS485	Modbus RS485 bus cable connected incorrectly	Check the terminal assignment .
No connection via Modbus RS485	Modbus RS485 cable incorrectly terminated	Check terminating resistor (→  28).
No connection via Modbus RS485	Incorrect settings for the communication interface	Check the Modbus RS485 configuration (→  41).
No connection via service interface	Incorrect configuration of USB interface on PC or driver not installed correctly.	Observe the documentation for the Commubox.  FXA291: Document "Technical Information" TI00405C

12.2 Diagnostic information via light emitting diodes

12.2.1 Transmitter

Various light emitting diodes (LEDs) on the main electronics module of the transmitter provide information on device status.

LED	Color	Meaning
Power	Off	Supply voltage is off or too low
	Green	Supply voltage is ok
Alarm	Off	Device status is ok
	Flashing red	A device error of diagnostic behavior "Warning" has occurred

LED	Color	Meaning
	Red	<ul style="list-style-type: none"> A device error of diagnostic behavior "Alarm" has occurred Boot loader is active
Communication	Flashing white	Modbus RS485 communication is active

12.2.2 Safety Barrier Promass 100

Various light emitting diodes (LEDs) on the Safety Barrier Promass 100 provide status information.

LED	Color	Color
Power	Off	Supply voltage is off or too low.
	Green	Supply voltage is ok.
Communication	Flashing white	Modbus RS485 communication is active.

12.3 Diagnostic information in FieldCare

12.3.1 Diagnostic options

Any faults detected by the measuring device are displayed on the home page of the operating tool once the connection has been established.

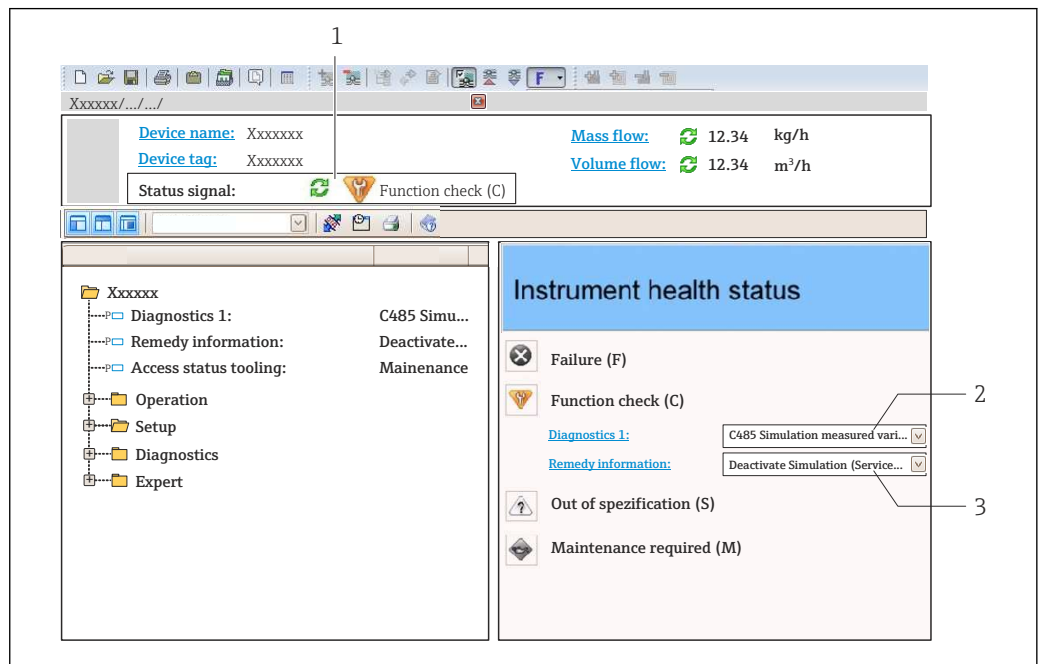





- 1 Status area with status signal
- 2 Diagnostic informatio (→ 54)n
- 3 Remedial measures with Service ID

i Furthermore, diagnostic events that have occurred can be viewed in the **Diagnostics** menu:

- Via parameters
- Via submenu (→ 58)

Status signals

The status signals provide information on the state and reliability of the device by categorizing the cause of the diagnostic information (diagnostic event).

Symbol	Meaning
 A0017271	Failure A device error has occurred. The measured value is no longer valid.
 A0017278	Function check The device is in service mode (e.g. during a simulation).
 A0017277	Out of specification The device is operated: Outside its technical specification limits (e.g. outside the process temperature range)
 A0017276	Maintenance required Maintenance is required. The measured value is still valid.

 The status signals are categorized in accordance with VDI/VDE 2650 and NAMUR Recommendation NE 107.

Diagnostic information

The fault can be identified using the diagnostic information. The short text helps you by providing information about the fault.

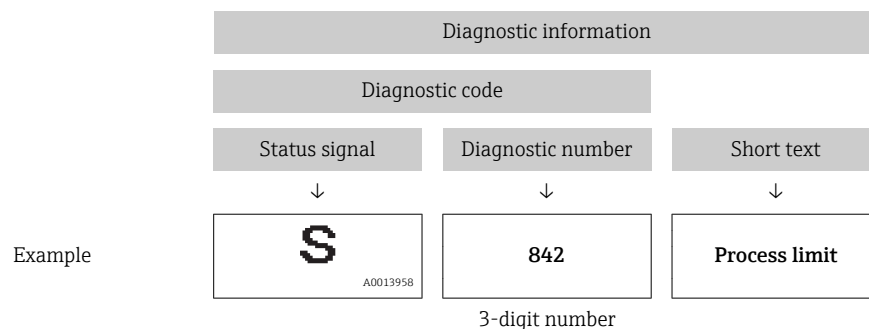

12.3.2 Calling up remedy information

Remedy information is provided for every diagnostic event to ensure that problems can be rectified quickly:

- On the home page
Remedy information is displayed in a separate field below the diagnostics information.
- In the **Diagnostics** menu
Remedy information can be called up in the working area of the user interface.

The user is in the **Diagnostics** menu.

1. Call up the desired parameter.
2. On the right in the working area, mouse over the parameter.
 - ↳ A tool tip with remedy information for the diagnostic event appears.

12.4 Diagnostic information via communication interface

12.4.1 Reading out diagnostic information

Diagnostic information can be read out via Modbus RS485 register addresses.

- Via register address **6821** (data type = string): diagnosis code, e.g. F270
- Via register address **6859** (data type = integer): diagnosis number, e.g. 270

 For an overview of diagnostic events with diagnosis number and diagnosis code (→  56)



12.4.2 Configuring error response mode

Error response mode for Modbus RS485 communication can be configured in the **Communication** submenu using 2 parameters.

Navigation path

"Setup" menu → Communication

Parameter overview with brief description

Parameter	Description	Options	Factory setting
Assign diagnostic behavior	Select diagnostic behavior for MODBUS communication.	<ul style="list-style-type: none"> ▪ Off ▪ Alarm or warning ▪ Warning ▪ Alarm 	Alarm
Failure mode	Select measured value output behavior when a diagnostic message occurs via Modbus communication.  This parameter operates in accordance with the option selected in the Assign diagnostic behavior parameter.	<ul style="list-style-type: none"> ▪ NaN value ▪ Last valid value  NaN = not a number	NaN value

12.5 Adapting the diagnostic information

12.5.1 Adapting the diagnostic behavior

Each item of diagnostic information is assigned a specific diagnostic behavior at the factory. The user can change this assignment for certain diagnostics information in the **Diagnostic behavior** submenu .

"Expert" menu → System → Diagnostic handling → Diagnostic behavior

You can assign the following options to the diagnostic number as the diagnostic behavior:

Options	Description
Alarm	Measurement is interrupted. Measured value output via Modbus RS485 and totalizers assume the defined alarm condition. A diagnostic message is generated.
Warning	Measurement is resumed. Measured value output via Modbus RS485 and totalizers are not affected. A diagnostic message is generated.
Logbook entry only	The device continues to measure. The diagnostic message is entered in the Event logbook (events list) submenu only and is not displayed in alternation with the measured value display.
Off	The diagnostic event is ignored, and no diagnostic message is generated or entered.

12.6 Overview of diagnostic information



Diagnostic number	Short text	Repairing action	Status signal from the factory	Diagnostic behaviour from the factory
Diagnostic of sensor				
022	Sensor temperature	1.Change main electronic module 2.Change sensor	F	Alarm
044	Sensor drift	1.Check or change main electronics 2.Change sensor	S	Alarm ¹⁾
046	Sensor limit	1. Inspect sensor 2. Check process condition	S	Alarm ¹⁾
062	Sensor connection	1.Change main electronic module 2.Change sensor	F	Alarm
082	Data storage	1. Check module connections 2. Contact service	F	Alarm
083	Memory content	1. Restart device 2. Contact service	F	Alarm
144	Measuring error too high	1. Check or change sensor 2. Check process conditions	F	Alarm ¹⁾
190	Special event 1	Contact service	F	Alarm
191	Special event 5	Contact service	F	Alarm
192	Special event 9	Contact service	F	Alarm ¹⁾
Diagnostic of electronic				
242	Software incompatible	1. Check software 2. Flash or change main electronics module	F	Alarm
270	Main electronic failure	Change main electronic module	F	Alarm
271	Main electronic failure	1. Restart device 2. Change main electronic module	F	Alarm
272	Main electronic failure	1. Restart device 2. Contact service	F	Alarm
273	Main electronic failure	Change electronic	F	Alarm
274	Main electronic failure	Change electronic	S	Warning ¹⁾
311	Electronic failure	1. Reset device 2. Contact service	F	Alarm
390	Special event 2	Contact service	F	Alarm
391	Special event 6	Contact service	F	Alarm
392	Special event 10	Contact service	F	Alarm ¹⁾
Diagnostic of configuration				
410	Data transfer	1. Check connection 2. Retry data transfer	F	Alarm
411	Up-/download active	Up-/download active, please wait	C	Warning
438	Dataset	1. Check data set file 2. Check device configuration 3. Up- and download new configuration	M	Warning

Diagnostic number	Short text	Repairing action	Status signal from the factory	Diagnostic behaviour from the factory
453	Flow override	Deactivate flow override	C	Warning
484	Simulation failure mode	Deactivate simulation	C	Alarm
485	Simulation measured variable	Deactivate simulation	C	Warning
590	Special event 3	Contact service	M	Alarm
591	Special event 7	Contact service	M	Alarm
592	Special event 11	Contact service	M	Alarm ¹⁾
Diagnostic of process				
830	Ambient temperature	Reduce ambient temp. around the sensor housing	S	Warning
831	Ambient temperature	Increase ambient temp. around the sensor housing	S	Warning
832	Ambient temperature	Reduce ambient temperature	S	Warning ¹⁾
833	Ambient temperature	Increase ambient temperature	S	Warning ¹⁾
834	Process temperature	Reduce process temperature	S	Warning ¹⁾
835	Process temperature	Increase process temperature	S	Warning ¹⁾
843	Process limit	Check process conditions	S	Warning
862	Partly filled pipe	1. Check for gas in process 2. Adjust detection limits	S	Warning
910	Tubes not oscillating	1. Check electronic 2. Inspect sensor	F	Alarm
912	Inhomogeneous	1. Check process cond. 2. Increase system pressure	S	Warning ¹⁾
913	Inhomogeneous	1. Check process conditions 2. Check electronic modules or sensor	S	Alarm ¹⁾
944	Monitoring failed	Check process conditions for Heartbeat Monitoring	S	Warning ¹⁾
990	Special event 4	Contact service	F	Alarm
991	Special event 8	Contact service	F	Alarm
992	Special event 12	Contact service	F	Alarm ¹⁾

1) Diagnostic status is changeable.

12.7 Pending diagnostic events

The **Diagnostics** menu allows the user to view the current diagnostic event and the previous diagnostic event separately.

 To call up the measures to rectify a diagnostic event:
Via "FieldCare" operating tool (→  54)

 Other pending diagnostic events can be displayed in the **Diagnostic list** submenu (→  58)

Navigation

"Diagnostics" menu

Structure of the submenu

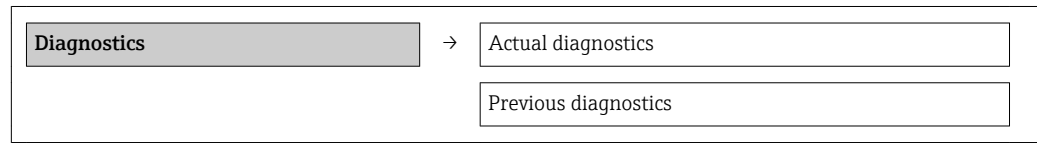

Parameter overview with brief description



Parameter	Prerequisite	Description	User interface	Factory setting
Actual diagnostics	1 diagnostic event has occurred.	Displays the current diagnostic event along with the diagnostic information.  If two or more messages occur simultaneously, the message with the highest priority is shown on the display.	Symbol for diagnostic behavior, diagnostic code and short message.	–
Previous diagnostics	2 diagnostic events have already occurred.	Displays the diagnostic event that occurred prior to the current diagnostic event along with the diagnostic information.	Symbol for diagnostic behavior, diagnostic code and short message.	–

12.8 Diagnostic list

In the **Diagnostic list** submenu, up to 5 currently pending diagnostic events can be displayed along with the related diagnostic information. If more than 5 diagnostic events are pending, the events with the highest priority are shown on the display.

Navigation path

Diagnostics menu → **Diagnostic list** submenu

 To call up the measures to rectify a diagnostic event:
Via "FieldCare" operating tool (→  54)

12.9 Event logbook

12.9.1 Event history



A chronological overview of the event messages that have occurred is provided in the events list which contains a maximum of 20 message entries. This list can be displayed via FieldCare if necessary.

Navigation path



Event list: **F** → Tool box → Additional functions



 For information on the event list, see the FieldCare user interface

This event history includes entries for:

- Diagnostic events (→  56)
- Information events (→  59)

In addition to the operation time of its occurrence and possible troubleshooting measures, each event is also assigned a symbol that indicates whether the event has occurred or is ended:

- Diagnostic event
 - : Event has occurred
 - : Event has ended
- Information event
 - : Event has occurred

 To call up the measures to rectify a diagnostic event:
Via "FieldCare" operating tool (→  54)

 For filtering the displayed event messages (→  59)

12.9.2 Filtering the event logbook

Using the **Filter options** parameter, you can define which category of event messages is displayed in the **Events list** submenu.

Navigation path

"Diagnostics" menu → Event logbook → Filter options

Filter categories

- All
- Failure (F)
- Function check (C)
- Out of specification (S)
- Maintenance required (M)
- Information (I)

12.9.3 Overview of information events

Unlike a diagnostic event, an information event is displayed in the event logbook only and not in the diagnostic list.

Info number	Info name
I1000	----- (Device ok)
I1089	Power on
I1090	Configuration reset
I1091	Configuration changed
I1110	Write protection switch changed
I1111	Density adjust failure
I1151	History reset
I1209	Density adjustment ok
I1221	Zero point adjust failure
I1222	Zero point adjustment ok
I1444	Device verification passed
I1445	Device verification failed
I1446	Device verification active
I1447	Record application reference data
I1448	Application reference data recorded
I1449	Recording application ref. data failed
I1450	Monitoring off
I1451	Monitoring on

Info number	Info name
I1457	Failed:Measured error verification
I1459	Failed: I/O module verification
I1460	Failed: Sensor integrity verification
I1461	Failed: Sensor verification
I1462	Failed:Sensor electronic module verific.

12.10 Resetting the measuring device

Using the **Device reset** parameter it is possible to reset the entire device configuration or some of the configuration to a defined state.

"Setup" menu → Advanced setup → Administration

Function scope of "Device reset" parameter

Options	Description
Cancel	No action is executed and the user exits the parameter.
To delivery settings	Every parameter for which a customer-specific default setting was ordered is reset to this customer-specific value. All other parameters are reset to the factory setting.  This option is not visible if no customer-specific settings have been ordered.
Restart device	The restart resets every parameter whose data are in the volatile memory (RAM) to the factory setting (e.g. measured value data). The device configuration remains unchanged.
History reset	Every parameter is reset to its factory setting.

12.11 Device information

The **Device information** submenu contains all the parameters that display different information for identifying the device.

Navigation

"Diagnostics" menu → Device information

Device information	→	Device tag
		Serial number
		Firmware version
		Device name
		Order code
		Extended order code 1
		Extended order code 2
		Extended order code 3
		ENP version

Parameter overview with brief description

Parameter	Description	User interface	Factory setting
Device tag	Enter tag for measuring point.	Max. 32 characters, such as letters, numbers or special characters (e.g. @, %, /)	Promass 100
Serial number	Displays the serial number of the measuring device.	Max. 11-digit character string comprising letters and numbers.	79AFF16000
Firmware version	Displays the device firmware version installed.	Character string with the following format: xx.yy.zz	01.02
Device name	Displays the name of the transmitter.	Character string composed of letters, numbers and certain punctuation marks.	Promass 100
Order code	Displays the device order code.	Character string composed of letters, numbers and certain punctuation marks	-
Extended order code 1	Displays the 1st part of the extended order code.	Character string	-
Extended order code 2	Displays the 2nd part of the extended order code.	Character string	-
Extended order code 3	Displays the 3rd part of the extended order code.	Character string	-
ENP version	Displays the version of the electronic nameplate.	Character string in the format xx.yy.zz	2.02.00

12.12 Firmware history

Release date	Firmware version	Order code for "Firmware version"	Firmware changes	Documentation type	Documentation
04.2013	01.02.00	Option 78	Original firmware	Operating Instructions	BA01261D/06/EN/01.13

 Flashing the firmware to the current version or to the previous version is possible via the service interface (CDI) .

 For the compatibility of the firmware version with the previous version, the installed device description files and operating tools, observe the information about the device in the "Manufacturer's information" document.

 The manufacturer's information is available:

- In the Download Area of the Endress+Hauser Internet site: www.endress.com → Download
- Specify the following details:
 - Product root, e.g. 8E1B
 - Text search: Manufacturer's information
 - Search range: documentation

13 Maintenance

13.1 Maintenance tasks

No special maintenance work is required.

13.1.1 Exterior cleaning

When cleaning the exterior of measuring devices, always use cleaning agents that do not attack the surface of the housing or the seals.

13.1.2 Interior cleaning

Observe the following points for CIP and SIP cleaning:

- Use only cleaning agents to which the process-wetted materials are adequately resistant.
- Observe the maximum permitted medium temperature for the measuring device (→  73).

13.2 Measuring and test equipment

Endress+Hauser offers a wide variety of measuring and test equipment, such as W@M or device tests.

 Your Endress+Hauser Sales Center can provide detailed information on the services.

 For a list of some of the measuring and test equipment, refer to the "Accessories" chapter of the "Technical Information" document for the device.

13.3 Endress+Hauser services

Endress+Hauser offers a wide variety of services for maintenance such as recalibration, maintenance service or device tests.

 Your Endress+Hauser Sales Center can provide detailed information on the services.

14 Repair

14.1 General notes

Repair and conversion concept

The Endress+Hauser repair and conversion concept provides for the following:

- The measuring devices have a modular design.
- Spare parts are grouped into logical kits with the associated Installation Instructions.
- Repairs are carried out by Endress+Hauser Service or by correspondingly trained customers.
- Certified devices can be converted into other certified devices by Endress+Hauser Service or at the factory only.

Notes for repair and conversion

For repair and modification of a measuring device, observe the following notes:

- Use only original Endress+Hauser spare parts.
- Carry out the repair according to the Installation Instructions.
- Observe the applicable standards, federal/national regulations, Ex documentation (XA) and certificates.
- Document every repair and each conversion and enter them into the *W@M* life cycle management database.

14.2 Spare parts

W@M Device Viewer (www.endress.com/deviceviewer):

All the spare parts for the measuring device, along with the order code, are listed here and can be ordered. If available, users can also download the associated Installation Instructions.



Measuring device serial number:

- Is located on the nameplate of the device.
- Can be read out via the **Serial number** parameter in the **Device information** submenu (→ 60).

14.3 Endress+Hauser services



Contact your Endress+Hauser Sales Center for information on services and spare parts.

14.4 Return

The measuring device must be returned if repairs or a factory calibration are required, or if the wrong measuring device has been ordered or delivered. According to legal regulations, Endress+Hauser, as an ISO-certified company, is required to follow certain procedures when handling returned products that are in contact with medium.

To ensure swift, safe and professional device returns, please read the return procedures and conditions on the Endress+Hauser website at www.services.endress.com/return-material

14.5 Disposal

14.5.1 Removing the measuring device

1. Switch off the device.

2. **WARNING!** Danger to persons from process conditions. Beware of hazardous process conditions such as pressure in the measuring device, high temperatures or aggressive fluids.

Carry out the mounting and connection steps from the chapters "Mounting the measuring device" and "Connecting the measuring device" in the logically reverse sequence. Observe the safety instructions.

14.5.2 Disposing of the measuring device

WARNING

Danger to personnel and environment from fluids that are hazardous to health.

- ▶ Ensure that the measuring device and all cavities are free of fluid residues that are hazardous to health or the environment, e.g. substances that have permeated into crevices or diffused through plastic.

Observe the following notes during disposal:

- Observe valid federal/national regulations.
- Ensure proper separation and reuse of the device components.

15 Accessories

Various accessories, which can be ordered with the device or subsequently from Endress+Hauser, are available for the device. Detailed information on the order code in question is available from your local Endress+Hauser sales center or on the product page of the Endress+Hauser website: www.endress.com.

15.1 Communication-specific accessories

Accessories	Description
Commubox FXA291	<p>Connects Endress+Hauser field devices with a CDI interface (= Endress+Hauser Common Data Interface) and the USB port of a computer or laptop.</p> <p> For details, see "Technical Information" TI00405C</p>

15.2 Service-specific accessories

Accessories	Description
Applicator	<p>Software for selecting and sizing Endress+Hauser measuring devices:</p> <ul style="list-style-type: none"> ▪ Calculation of all the necessary data for identifying the optimum flowmeter: e.g. nominal diameter, pressure loss, accuracy or process connections. ▪ Graphic illustration of the calculation results <p>Administration, documentation and access to all project-related data and parameters over the entire life cycle of a project.</p> <p>Applicator is available:</p> <ul style="list-style-type: none"> ▪ Via the Internet: https://wapps.endress.com/applicator ▪ On CD-ROM for local PC installation.
W@M	<p>Life cycle management for your plant</p> <p>W@M supports you with a wide range of software applications over the entire process: from planning and procurement, to the installation, commissioning and operation of the measuring devices. All the relevant device information, such as the device status, spare parts and device-specific documentation, is available for every device over the entire life cycle.</p> <p>The application already contains the data of your Endress+Hauser device. Endress+Hauser also takes care of maintaining and updating the data records.</p> <p>W@M is available:</p> <ul style="list-style-type: none"> ▪ Via the Internet: www.endress.com/lifecyclemanagement ▪ On CD-ROM for local PC installation.
FieldCare	<p>FDT-based plant asset management tool from Endress+Hauser.</p> <p>It can configure all smart field units in your system and helps you manage them. By using the status information, it is also a simple but effective way of checking their status and condition.</p> <p> For details, see Operating Instructions BA00027S and BA00059S</p>

16 Technical data

16.1 Application

The measuring device is suitable for flow measurement of liquids and gases only.

Depending on the version ordered, the measuring device can also measure potentially explosive, flammable, poisonous and oxidizing media.

To ensure that the device remains in proper operating condition for its service life, use the measuring device only for media against which the process-wetted materials are adequately resistant.

16.2 Function and system design

Measuring principle	Mass flow measurement based on the Coriolis measuring principle
Measuring system	<p>The device consists of a transmitter and a sensor. If a device with Modbus RS485 intrinsically safe is ordered, the Safety Barrier Promass 100 is part of the scope of supply and must be implemented to operate the device.</p> <p>One device version is available: compact version, transmitter and sensor form a mechanical unit.</p> <p>For information on the structure of the device (→  11)</p>

16.3 Input

Measured variable	<p>Direct measured variables</p> <ul style="list-style-type: none"> ■ Mass flow ■ Density ■ Temperature <p>Calculated measured variables</p> <ul style="list-style-type: none"> ■ Volume flow ■ Corrected volume flow ■ Reference density
-------------------	---

Measuring range	Measuring ranges for liquids			
	DN		Measuring range full scale values $\dot{m}_{\min(F)}$ to $\dot{m}_{\max(F)}$	
	[mm]	[in]	[kg/h]	[lb/min]
	8	$\frac{3}{8}$	0 to 2 000	0 to 73.5
	15	$\frac{1}{2}$	0 to 6 500	0 to 238
	25	1	0 to 18 000	0 to 660

Recommended measuring range

"Flow limit" section (→  73)

Operable flow range Over 1000 : 1.
Flow rates above the preset full scale value are not overridden by the electronics unit, with the result that the totalizer values are registered correctly.

16.4 Output

Output signal **Modbus RS485**

Physical interface	In accordance with EIA/TIA-485-A standard
Terminating resistor	Integrated, can be activated via DIP switch on the transmitter electronics module

Signal on alarm Depending on the interface, failure information is displayed as follows:

Modbus RS485

Failure mode	Choose from: <ul style="list-style-type: none"> ▪ NaN value instead of current value ▪ Last valid value
---------------------	---

Operating tool

Via service interface

Plain text display	With information on cause and remedial measures
---------------------------	---

Light emitting diodes (LED)

Status information	Status indicated by various light emitting diodes The following information is displayed depending on the device version: <ul style="list-style-type: none"> ▪ Supply voltage active ▪ Data transmission active ▪ Device alarm/error has occurred
---------------------------	---



Low flow cut off The switch points for low flow cut off are user-selectable.

Galvanic isolation The following connections are galvanically isolated from each other:

- Outputs
- Power supply

Protocol-specific data **Modbus RS485**

Protocol	Modbus Applications Protocol Specification V1.1
Device type	Slave
Slave address range	1 to 247
Broadcast address range	0

Function codes	<ul style="list-style-type: none"> ▪ 03: Read holding register ▪ 04: Read input register ▪ 06: Write single registers ▪ 08: Diagnostics ▪ 16: Write multiple registers ▪ 23: Read/write multiple registers
Broadcast messages	<p>Supported by the following function codes:</p> <ul style="list-style-type: none"> ▪ 06: Write single registers ▪ 16: Write multiple registers ▪ 23: Read/write multiple registers
Supported baud rate	<ul style="list-style-type: none"> ▪ 1 200 BAUD ▪ 2 400 BAUD ▪ 4 800 BAUD ▪ 9 600 BAUD ▪ 19 200 BAUD ▪ 38 400 BAUD ▪ 57 600 BAUD ▪ 115 200 BAUD
Data transfer mode	<ul style="list-style-type: none"> ▪ ASCII ▪ RTU
Data access	<p>Each device parameter can be accessed via Modbus RS485.</p> <p> For Modbus register information (→  77)</p>

16.5 Power supply

Terminal assignment (→  24)

Supply voltage

Transmitter

- For device version with all communication types except Modbus RS485 intrinsically safe: DC 20 to 30 V
- For device version with Modbus RS485 intrinsically safe: power supply via Safety Barrier Promass 100

The power unit must be tested to ensure it meets safety requirements (e.g. PELV, SELV).

Safety Barrier Promass 100

DC 20 to 30 V

Power consumption

Transmitter

Order code for "Output"	Maximum Power consumption
Option M : Modbus RS485, for use in intrinsically safe areas	2.45 W

Safety Barrier Promass 100

Order code for "Output"	Maximum Power consumption
Option M : Modbus RS485, for use in intrinsically safe areas	4.8 W

Current consumption

Transmitter

Order code for "Output"	Maximum Current consumption	Maximum switch-on current
Option M : Modbus RS485, for use in intrinsically safe areas	145 mA	16 A (<0.4 ms)

Safety Barrier Promass 100

Order code for "Output"	Maximum Current consumption	Maximum switch-on current
Option M : Modbus RS485, for use in intrinsically safe areas	230 mA	10 A (<0.8 ms)

Power supply failure

- Totalizers stop at the last value measured.
- Configuration is retained in the device memory.
- Error messages (incl. total operated hours) are stored.

Electrical connection

(→  26)

Potential equalization

No special measures for potential equalization are required.

Terminals

Transmitter

Spring terminals for wire cross-sections 0.5 to 2.5 mm² (20 to 14 AWG)

Safety Barrier Promass 100

Plug-in screw terminals for wire cross-sections 0.5 to 2.5 mm² (20 to 14 AWG)

Cable entries

- Cable gland: M20 × 1.5 with cable ϕ 6 to 12 mm (0.24 to 0.47 in)
- Thread for cable entry:
 - NPT ½"
 - G ½"
 - M20

Cable specification

(→  22)

16.6 Performance characteristics

Reference operating conditions

- Error limits based on ISO 11631
- Water with +15 to +45 °C (+59 to +113 °F) at 2 to 6 bar (29 to 87 psi)
- Specifications as per calibration protocol
- Accuracy based on accredited calibration rigs that are traced to ISO 17025.



To obtain measured errors, use the *Applicator* sizing tool (→  77)

Maximum measured error

o.r. = of reading; 1 g/cm³ = 1 kg/l; T = medium temperature

Base accuracy**Mass flow and volume flow (liquids)**

±0.15 % o.r.

 Design fundamentals (→  71)

Density (liquids)

- Reference conditions: ±0.0005 g/cm³
- Standard density calibration: ±0.02 g/cm³
(valid over the entire temperature range and density range)

Temperature

$\pm 0.5\text{ }^{\circ}\text{C} \pm 0.005 \cdot T\text{ }^{\circ}\text{C} (\pm 0.9\text{ }^{\circ}\text{F} \pm 0.003 \cdot (T - 32)\text{ }^{\circ}\text{F})$

Zero point stability

DN		Zero point stability	
[mm]	[in]	[kg/h]	[lb/min]
8	$\frac{3}{8}$	0.2	0.0074
15	$\frac{1}{2}$	0.65	0.0239
25	1	1.8	0.0662

Flow values

Flow values as turndown parameter depending on nominal diameter.

SI units

DN	1:1	1:10	1:20	1:50	1:100	1:500
[mm]	[kg/h]	[kg/h]	[kg/h]	[kg/h]	[kg/h]	[kg/h]
8	2000	200	100	40	20	4
15	6500	650	325	130	65	13
25	18000	1800	900	360	180	36

US units

DN	1:1	1:10	1:20	1:50	1:100	1:500
[inch]	[lb/min]	[lb/min]	[lb/min]	[lb/min]	[lb/min]	[lb/min]
$\frac{3}{8}$	73.5	7.35	3.675	1.47	0.735	0.147
$\frac{1}{2}$	238	23.8	11.9	4.76	2.38	476
1	660	66	33	13.2	6.6	1.32

Repeatability

o.r. = of reading; 1 g/cm³ = 1 kg/l; T = medium temperature

Base repeatability

Mass flow and volume flow (liquids)

±0.075 % o.r.

 Design fundamentals (→  71)

Density (liquids)

±0.00025 g/cm³

Temperature

$\pm 0.25\text{ }^{\circ}\text{C} \pm 0.0025 \cdot T\text{ }^{\circ}\text{C} (\pm 0.45\text{ }^{\circ}\text{F} \pm 0.0015 \cdot (T - 32)\text{ }^{\circ}\text{F})$

Response time

- The response time depends on the configuration (damping).
- Response time in the event of erratic changes in the measured variable (only mass flow): after 100 ms, 95 % of the full scale value

Influence of medium temperature

Mass flow and volume flow
 When there is a difference between the temperature for zero point adjustment and the process temperature, the typical measured error of the sensor is $\pm 0.0002\%$ of the full scale value/ $^{\circ}\text{C}$ ($\pm 0.0001\%$ of the full scale value/ $^{\circ}\text{F}$).

Density
 When there is a difference between the density calibration temperature and the process temperature, the typical measured error of the sensor is $\pm 0.0001\text{ g/cm}^3\text{ }^{\circ}\text{C}$ ($\pm 0.00005\text{ g/cm}^3\text{ }^{\circ}\text{F}$). Field density calibration is possible.

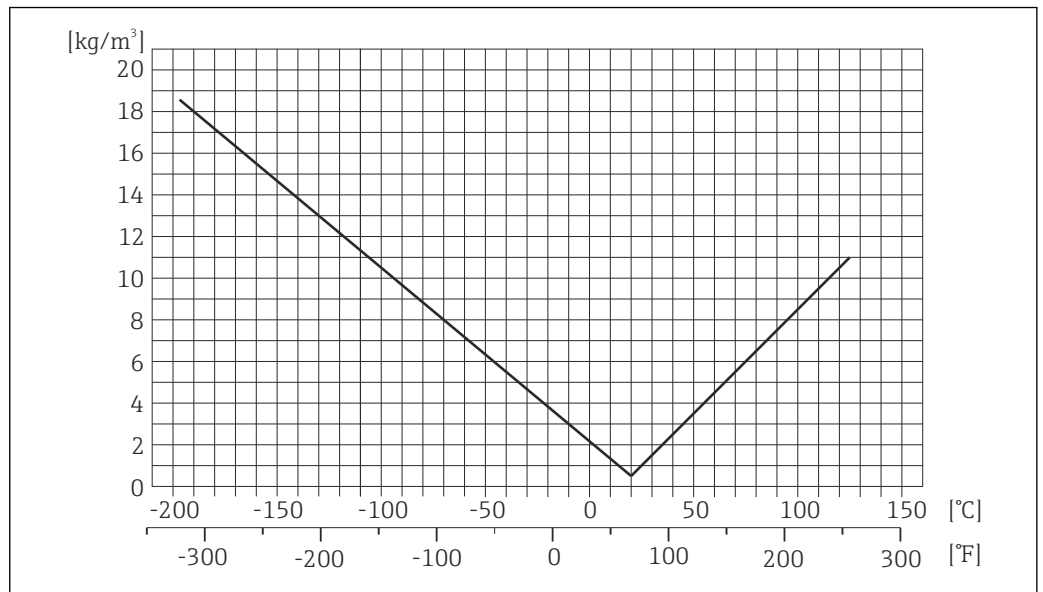

13 Field density calibration, for example at +20 °C (+68 °F)

Temperature
 $\pm 0.005 \cdot T\text{ }^{\circ}\text{C}$ ($\pm 0.005 \cdot (T - 32)\text{ }^{\circ}\text{F}$)

Influence of medium pressure

A difference between the calibration pressure and process pressure does not affect accuracy.

Design fundamentals

o.r. = of reading, o.f.s. = of full scale value
 BaseAccu = base accuracy in % o.r., BaseRepeat = base repeatability in % o.r.
 MeasValue = measured value; ZeroPoint = zero point stability

Calculation of the maximum measured error as a function of the flow rate

Flow rate	Maximum measured error in % o.r.
$\geq \frac{\text{ZeroPoint}}{\text{BaseAccu}} \cdot 100$ <small>A0021332</small>	$\pm \text{BaseAccu}$ <small>A0021339</small>
$< \frac{\text{ZeroPoint}}{\text{BaseAccu}} \cdot 100$ <small>A0021333</small>	$\pm \frac{\text{ZeroPoint}}{\text{MeasValue}} \cdot 100$ <small>A0021334</small>

Calculation of the maximum repeatability as a function of the flow rate

Flow rate	Maximum repeatability in % o.r.
$\geq \frac{1/2 \cdot \text{ZeroPoint}}{\text{BaseRepeat}} \cdot 100$ <small>A0021335</small>	$\pm \text{BaseRepeat}$ <small>A0021340</small>
$< \frac{1/2 \cdot \text{ZeroPoint}}{\text{BaseRepeat}} \cdot 100$ <small>A0021336</small>	$\pm 1/2 \cdot \frac{\text{ZeroPoint}}{\text{MeasValue}} \cdot 100$ <small>A0021337</small>

Example for max. measured error

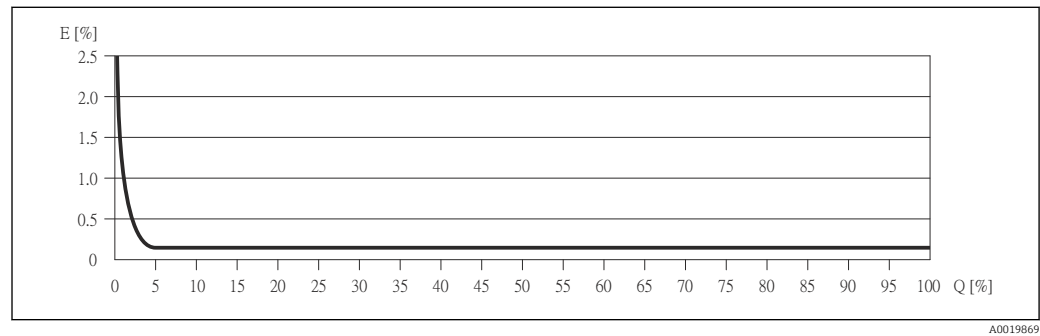

E Error: Maximum measured error as % o.r. (example)
Q Flow rate as %

Design fundamentals (→ 71)

16.7 Installation





"Mounting requirements" (→ 18)

16.8 Environment

Ambient temperature range	(→ 19)
Storage temperature	-40 to +80 °C (-40 to +176 °F), preferably at +20 °C (+68 °F)
Climate class	DIN EN 60068-2-38 (test Z/AD)
Degree of protection	<p>Transmitter and sensor</p> <ul style="list-style-type: none"> ■ As standard: IP66/67, type 4X enclosure ■ When housing is open: IP20, type 1 enclosure <p>Safety Barrier Promass 100 IP20</p>
Shock resistance	As per IEC/EN 60068-2-31
Vibration resistance	Acceleration up to 1 g, 10 to 150 Hz, based on IEC/EN 60068-2-6

Electromagnetic compatibility (EMC)	<ul style="list-style-type: none"> ■ As per IEC/EN 61326 and NAMUR Recommendation 21 (NE 21) ■ Complies with emission limits for industry as per EN 55011 (Class A) <p> Details are provided in the Declaration of Conformity.</p>
-------------------------------------	---

16.9 Process

Medium temperature range	<p>Sensor -196 to +125 °C (-320 to +257 °F)</p> <p>Seals No internal seals</p>
Medium density	0 to 5 000 kg/m ³ (0 to 312 lb/cf)
Pressure-temperature ratings	<p> An overview of the material load diagrams (pressure/temperature curves) for the process connections is provided in the "Technical Information" document for the device on the CD-ROM provided.</p>
Secondary containment pressure range	<p>The sensor housing is filled with helium and protects the electronics and mechanics inside. The housing does not have pressure vessel classification.</p> <p>Reference value for the pressure loading capacity of the sensor housing: 16 bar (232 psi)</p>
Flow limit	<p>Select the nominal diameter by optimizing between the required flow range and permissible pressure loss.</p> <p> For an overview of the measuring range full scale values, see the "Measuring range" section (→  66)</p> <ul style="list-style-type: none"> ■ The minimum recommended full scale value is approx. 1/20 of the maximum full scale value ■ In most applications, 20 to 50 % of the maximum full scale value can be considered ideal ■ Select a lower full scale value for abrasive substances (such as liquids with entrained solids): flow velocity <1 m/s (<3 ft/s).
Pressure loss	<p> To calculate the pressure loss, use the <i>Applicator</i> sizing tool (→  77)</p>

16.10 Mechanical construction

Design, dimensions



For the dimensions and installation lengths of the device, see the "Technical Information" document, "Mechanical construction" section

Weight

Compact version

Weight in SI units

All values (weight) refer to devices with EN/DIN PN 40 flanges. Weight information in [kg].

DN [mm]	Weight [kg]
8	6
15	6
25	8

Weight in US units

All values (weight) refer to devices with EN/DIN PN 40 flanges. Weight information in [lbs].

DN [in]	Weight [lbs]
3/8	13
1/2	13
1	18

Safety Barrier Promass 100

49 g (1.73 ounce)

Materials

Transmitter housing

Order code for "Housing", option **A** "Compact, aluminum coated":
Coated aluminum AISi10Mg

Cable entries/cable glands

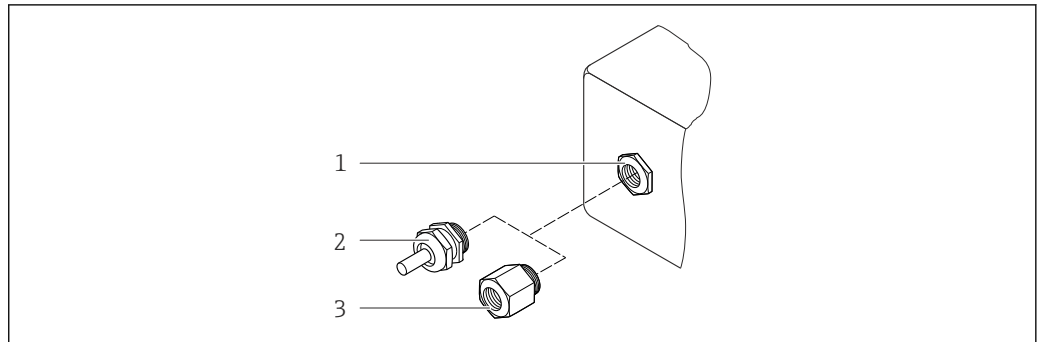

A0020640

14 Possible cable entries/cable glands

- 1 Cable entry in transmitter housing, wall-mount housing or connection housing with internal thread M20 x 1.5
- 2 Cable gland M20 x 1.5
- 3 Adapter for cable entry with internal thread G ½" or NPT ½"

Order code for "Housing", option A "Compact, coated aluminum"

The various cable entries are suitable for hazardous and non-hazardous areas.

Cable entry/cable gland	Material
Cable gland M20 x 1.5	Nickel-plated brass
Adapter for cable entry with internal thread G ½"	
Adapter for cable entry with internal thread NPT ½"	

Sensor housing

- Acid and alkali-resistant outer surface
- Stainless steel 1.4301 (304)

Measuring tubes

- Stainless steel 1.4539 (904L); manifold: 1.4404 (316L)
- Surface quality:
 - Not polished
 - $Ra_{max} = 0.8 \mu m$ (32 μin)

Process connections

For all process connections:
Stainless steel 1.4404 (316/316L)

 List of all available process connections (→  76)

Seals

Welded process connections without internal seals

Safety Barrier Promass 100

Housing: Polyamide

Process connections

Flanges:
 – EN 1092-1 (DIN 2501)
 – ASME B16.5



For information on the materials of the process connections (→ 75)

16.11 Operability

Remote operation

Service interface (CDI)

Operation of the measuring device with the service interface (CDI) via:
 "FieldCare" operating tool with COM DTM "CDI Communication FXA291" via Commubox
 FXA291

Languages

Can be operated in the following languages:
 Via "FieldCare" operating tool:
 English, German

16.12 Certificates and approvals

CE mark

The measuring system is in conformity with the statutory requirements of the applicable EC Directives. These are listed in the corresponding EC Declaration of Conformity along with the standards applied.

Endress+Hauser confirms successful testing of the device by affixing to it the CE mark.

C-Tick symbol

The measuring system meets the EMC requirements of the "Australian Communications and Media Authority (ACMA)".

Ex approval

The devices are certified for use in hazardous areas and the relevant safety instructions are provided in the separate "Safety Instructions" (XA) document. Reference is made to this document on the nameplate.

Modbus RS485 certification



The measuring device meets all the requirements of the MODBUS/TCP conformity test and has the "MODBUS/TCP Conformance Test Policy, Version 2.0". The measuring device has successfully passed all the test procedures carried out and is certified by the "MODBUS/TCP Conformance Test Laboratory" of the University of Michigan.

16.13 Application packages

Many different application packages are available to enhance the functionality of the device. Such packages might be needed to address safety aspects or specific application requirements.

The application packages can be ordered from Endress+Hauser either directly with the device or subsequently. Detailed information on the order code in question is available from your local Endress+Hauser sales center or on the product page of the Endress+Hauser website: www.endress.com.

16.14 Accessories

 Overview of accessories available for order (→  65)



16.15 Supplementary documentation

-  For an overview of the scope of the associated Technical Documentation, refer to the following:
- The CD-ROM provided for the device (depending on the device version, the CD-ROM might not be part of the delivery!)
 - The *W@M Device Viewer* : Enter the serial number from the nameplate (www.endress.com/deviceviewer)
 - The *Endress+Hauser Operations App*: Enter the serial number from the nameplate or scan the 2-D matrix code (QR code) on the nameplate.

Standard documentation

Communication	Document type	Documentation code
----	Brief Operating Instructions	KA01153D
----	Technical Information	TIO1124D

Supplementary device-dependent documentation

Document type	Contents	Documentation code
Safety Instructions	ATEX/IECEX Ex i	XA01217D
	cCSAus IS	XA01218D
	INMETRO	XA01246D
	NEPSI	XA01247D
Special Documentation	Modbus RS485 Register Information	SD01165D
Installation Instructions		Specified for each individual accessory (→  65)  Overview of accessories available for order (→  65)

17 Appendix

17.1 Overview of the operating menu

The following table provides an overview of the entire operating menu structure with menus and parameters. The page reference indicates where a description of the parameter can be found in the manual.

Display/operat. →		(→ 32)
Locking status		(→ 49)
	Operation →	(→ 51)
	Control totalizer 1 to 3	
	Preset value 1 to 3	(→ 51)
	Reset all totalizers	
Setup →		(→ 39)
	System units →	(→ 39)
	Mass flow unit	
	Mass unit	
	Volume flow unit	
	Volume unit	
	Corrected volume flow unit	
	Corrected volume unit	
	Density unit	
	Reference density unit	
	Temperature unit	
	Pressure unit	
	Medium selection →	
	Select medium	
	Select gas type	
	Reference sound velocity	
	Temperature coefficient sound velocity	
	Pressure compensation	
	Pressure value	
	External pressure	

Communication →		(→ 41)
Bus address		
Baud rate		
Data transfer mode		
Parity		
Byte order		
Assign diagnostic behavior		
Failure mode		
Low flow cut off →		(→ 43)
Assign process variable		
On value low flow cutoff		
Off value low flow cutoff		
Pressure shock suppression		
Partially filled pipe detection →		(→ 44)
Assign process variable		
Low value partial filled pipe detection		
High value partial filled pipe detection		
Response time part. filled pipe detect.		
Advanced setup →		(→ 45)
Enter access code		
Device tag		(→ 39)
	Calculated values →	(→ 45)
	Corrected volume flow calculation	
	External reference density	
	Fixed reference density	
	Reference temperature	
	Linear expansion coefficient	

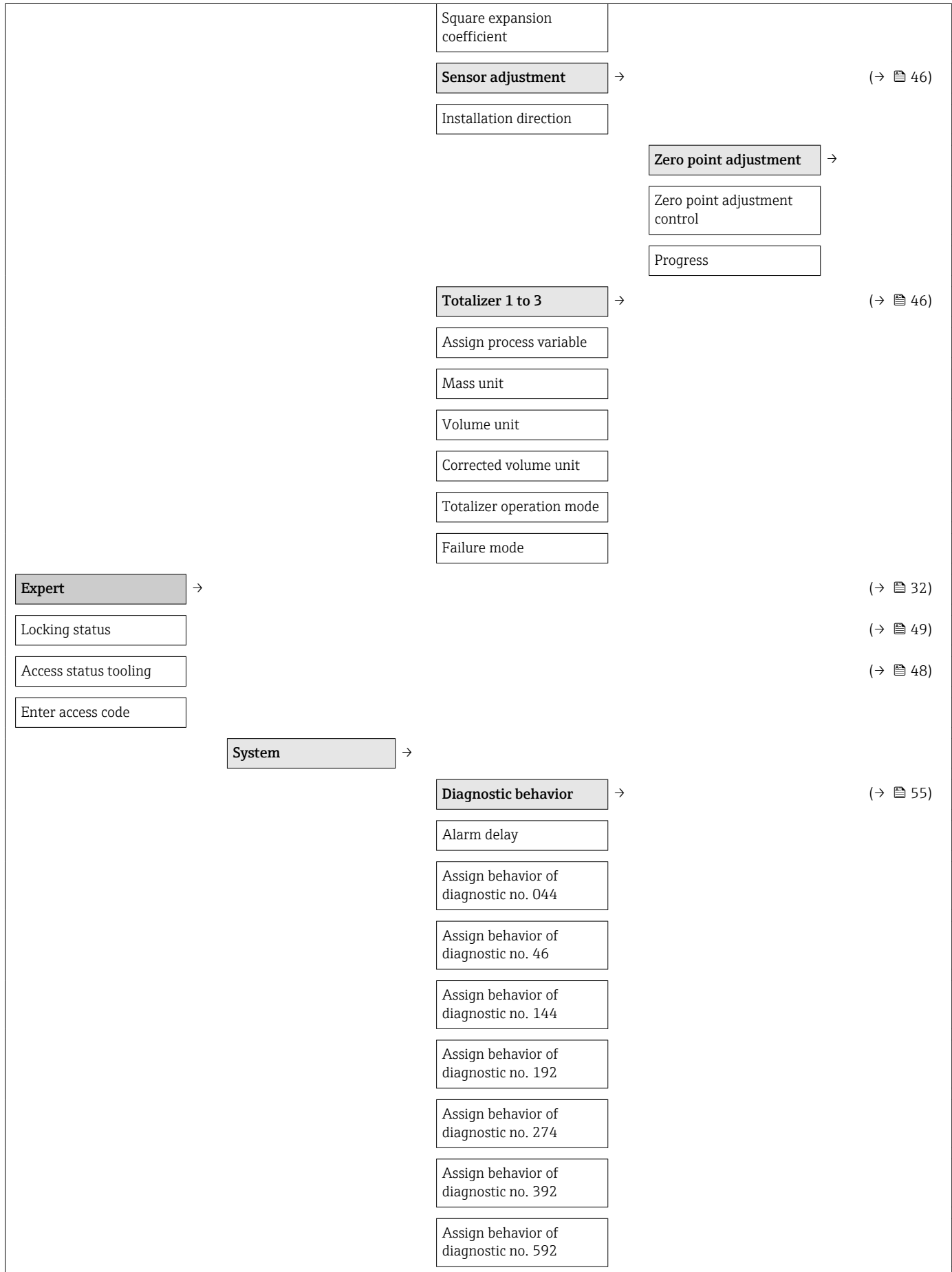

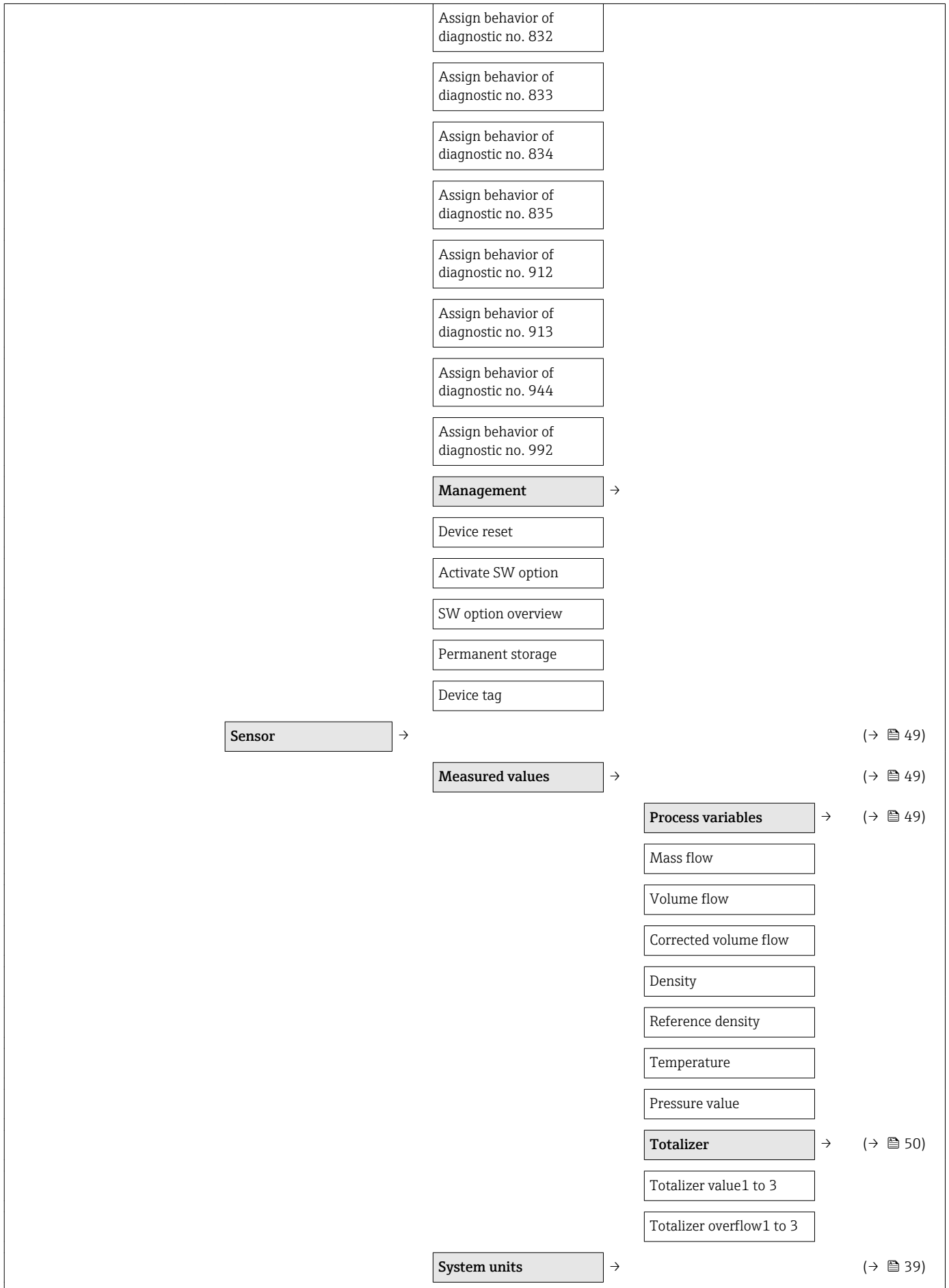

Mass flow unit	
Mass unit	
Volume flow unit	
Volume unit	
Corrected volume flow unit	
Corrected volume unit	
Density unit	
Reference density unit	
Temperature unit	
Pressure unit	
Date/time format	
	User-specific units →
	User mass text
	User mass factor
	User volume text
	User volume factor
	User corrected volume text
	User corrected volume factor
	User density text
	User density offset
	User density factor
	User pressure text
	User pressure offset
	User pressure factor
	Process param. →
	Flow damping
	Density damping
	Flow override
	Temperature damping
	Low flow cut off → (→ 43)

	Assign process variable	
	On value low flow cutoff	
	Off value low flow cutoff	
	Pressure shock suppression	
	Partially filled pipe detection	→ (→ 44)
	Assign process variable	
	Low value partial filled pipe detection	
	High value partial filled pipe detection	
	Response time part. filled pipe detect.	
	Maximum damping partial filled pipe det.	
	Measuring mode	→
	Select medium	
	Select gas type	
	Reference sound velocity	
	Temperature coefficient sound velocity	
	External compensation	→
	Pressure compensation	
	Pressure value	
	External pressure	
	Temperature mode	
	External temperature	
	Calculated values	→ (→ 45)
	Corrected volume flow calculation	
	External reference density	
	Fixed reference density	
	Reference temperature	
	Linear expansion coefficient	

Square expansion coefficient		
Sensor adjustment	→	(→ ⓘ 46)
Installation direction		
		Zero point adjustment →
		Zero point adjustment control
		Progress
		Variable adjust →
		Mass flow offset
		Mass flow factor
		Volume flow offset
		Volume flow factor
		Corrected volume flow offset
		Corrected volume flow factor
		Density offset
		Density factor
		Reference density offset
		Reference density factor
		Temperature offset
		Temperature factor
		Calibration →
		Calibration factor
		Zero point
		Nominal diameter
		CO to 5
		Testpoints →
		Oscillation frequency 0 to 1
		Frequency fluctuation 0 to 1
		Oscillation amplitude 0 to 1

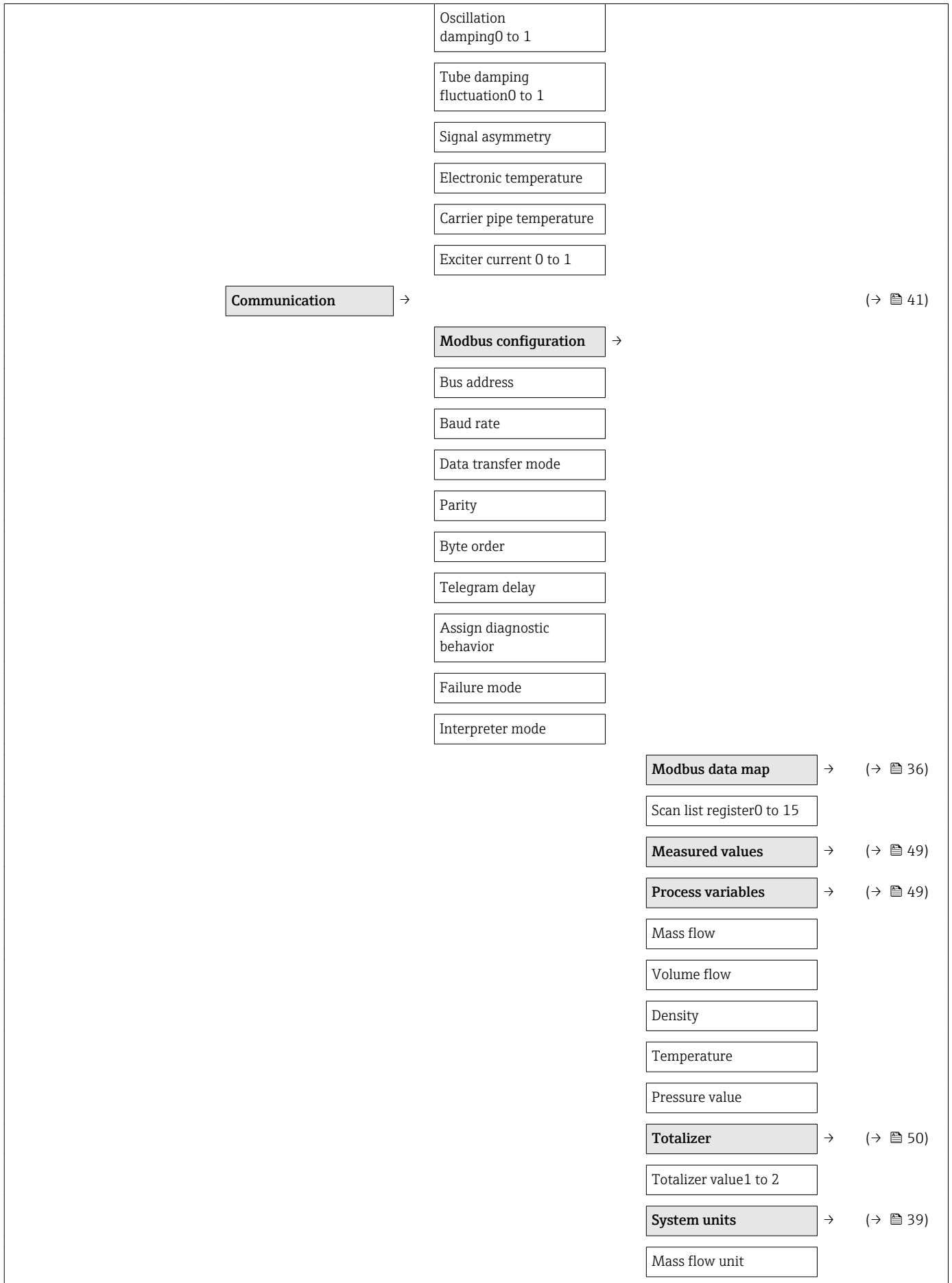

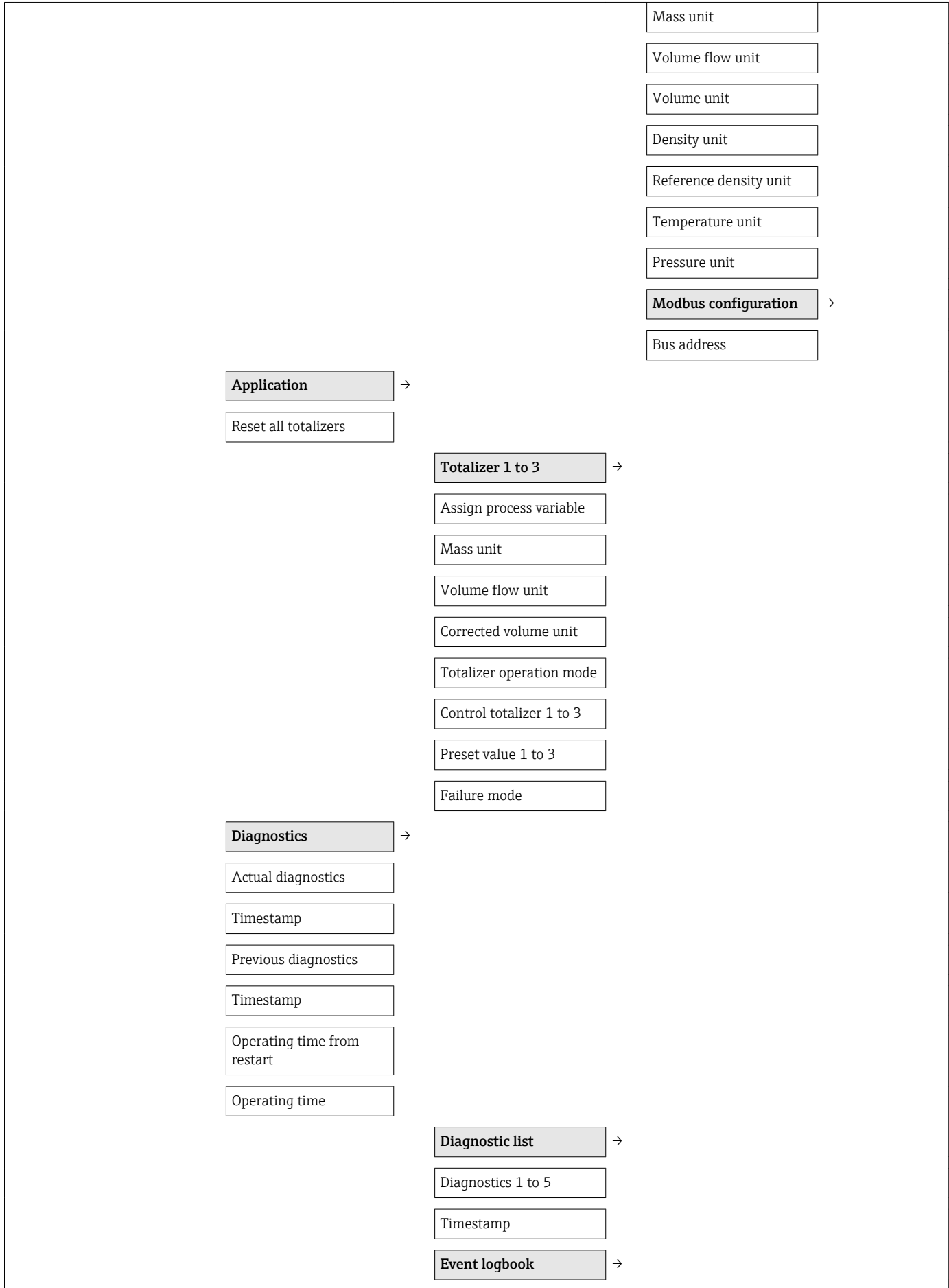

Filter options		
Device information	→	
Device tag		
Serial number		
Firmware version		
Device name		
Order code		
Extended order code1 to 3		
ENP version		
Configuration counter		
Min/max values	→	
Reset min/max values		
		Main electronic temperature →
		Minimum value
		Maximum value
		Medium temperature →
		Minimum value
		Maximum value
		Carrier pipe temperature →
		Minimum value
		Maximum value
		Oscillation frequency →
		Minimum value
		Maximum value
		Torsion oscillation frequency →
		Minimum value
		Maximum value
		Oscillation amplitude →
		Minimum value
		Maximum value

	Oscillation damping →	
	Minimum value	
	Maximum value	
	Signal asymmetry →	
	Minimum value	
	Maximum value	
	Simulation →	(→ 📄 47)
	Assign simulation process variable	
	Value process variable	
	Simulation device alarm	

Index

A

- Accuracy 69
- Adapting the diagnostic behavior 55
- Ambient temperature range 19
- Application 8, 66
- Application packages 76
- Approvals 76
- Auto scan buffer
 - see Modbus RS485 Modbus data map

C

- C-Tick symbol 76
- Cable entries
 - Technical data 69
- Cable entry
 - Degree of protection 29
- CE mark 9, 76
- Certificates 76
- Check
 - Installation 21
- Checklist
 - Post-connection check 29
 - Post-installation check 21
- Cleaning
 - CIP cleaning 62
 - Exterior cleaning 62
 - Interior cleaning 62
 - SIP cleaning 62
- Climate class 72
- Commissioning 39
 - Advanced settings 45
 - Configuring the measuring device 39
- Configuring error response mode, Modbus RS485 55
- Connecting cable 22
- Connecting the measuring device 26
- Connection
 - see Electrical connection
- Connection preparations 25
- Connection tools 22
- Current consumption 69

D

- Declaration of Conformity 9
- Degree of protection 29, 72
- Design
 - Measuring device 11
- Design fundamentals
 - Maximum measured error 71
 - Repeatability 71
- Designated use 8
- Device components 11
- Device description files 35, 35
- Device documentation
 - Supplementary documentation 7
- Device locking, status 49
- Device name

- Sensor 14
 - Transmitter 13
- Device repair 63
- Device revision 35
- Device type ID 35
- Diagnostic information
 - Communication interface 54
 - Design, description 54
 - FieldCare 53
 - Light emitting diodes 52
 - Overview 56
 - Remedial measures 56
- Diagnostic list 58
- DIP switch
 - see Write protection switch
- Disabling write protection 47
- Display
 - Current diagnostic event 57
 - Previous diagnostic event 57
- Display values
 - For locking status 49
- Disposal 63
- Document
 - Function 5
 - Symbols used 5
- Document function 5

E

- Electrical connection
 - Commubox FXA291 33
 - Degree of protection 29
 - Measuring device 22
 - Operating tools
 - Via service interface (CDI) 33
- Electromagnetic compatibility 73
- Enabling write protection 47
- Endress+Hauser services
 - Maintenance 62
 - Repair 63
- Error messages
 - see Diagnostic messages
- Event history 58
- Events list 58
- Ex approval 76
- Extended order code
 - Sensor 14
 - Transmitter 13
- Exterior cleaning 62

F

- Field of application
 - Residual risks 9
- FieldCare 33
 - Device description file 35
 - Establishing a connection 33
 - Function 33

- User interface 34
- Filtering the event logbook 59
- Firmware
 - Release date 35
 - Version 35
- Firmware history 61
- Flow direction 18, 20
- Flow limit 73
- Function check 39
- Function codes 35
- Functions
 - see Parameter
- G**
- Galvanic isolation 67
- H**
- Hardware write protection 48
- I**
- I/O electronics module 11, 26
- Identifying the measuring device 12
- Incoming acceptance 12
- Influence
 - Medium pressure 71
 - Medium temperature 71
- Information on the document 5
- Inlet runs 19
- Input 66
- Inspection check
 - Connection 29
 - Received goods 12
- Installation 18
- Installation conditions
 - Mounting location 18
 - Orientation 18
 - System pressure 19
 - Vibrations 20
- Installation dimensions 19
- Interior cleaning 62
- L**
- Languages, operation options 76
- Low flow cut off 67
- M**
- Main electronics module 11
- Maintenance tasks 62
- Manufacturer ID 35
- Manufacturing date 13, 14
- Materials 74
- Maximum measured error 69
- Measured variables
 - see Process variables
- Measuring and test equipment 62
- Measuring device
 - Configuring 39
 - Conversion 63
 - Design 11
 - Disposal 64
 - Integrating via HART protocol 35
 - Mounting the sensor 20
 - Preparing for electrical connection 25
 - Preparing for mounting 20
 - Removing 63
 - Repair 63
- Measuring principle 66
- Measuring range
 - For liquids 66
- Measuring range, recommended 73
- Measuring system 66
- Media 8
- Medium density 73
- Medium pressure
 - Influence 71
- Medium temperature
 - Influence 71
- menu
 - Diagnostics 57
 - Operation 49
- Menus
 - For measuring device configuration 39
 - For specific settings 45
- Modbus RS485
 - Configuring error response mode 55
 - Diagnostic information 54
 - Function codes 35
 - Modbus data map 36
 - Read access 35
 - Reading out data 37
 - Register addresses 36
 - Register information 36
 - Response time 36
 - Scan list 37
 - Write access 35
- Modbus RS485 certification 76
- Mounting dimensions
 - see Installation dimensions
- Mounting location 18
- Mounting preparations 20
- Mounting requirements
 - Inlet and outlet runs 19
 - Installation dimensions 19
- Mounting tools 20
- N**
- Nameplate
 - Safety Barrier Promass 100 15
 - Sensor 14
 - Transmitter 13
- O**
- Operable flow range 67
- Operating menu
 - Menus, submenus 31
 - Overview of menus with parameters 78
 - Structure 31
 - Submenus and user roles 32
- Operating philosophy 32

- Operation 49
- Operation options 30, 30
- Operational safety 9
- Order code 13, 14
- Orientation (vertical, horizontal) 18
- Outlet runs 19
- Output 67
- Output signal 67
- Overview
 - Operating menu 78
- P**
- Packaging disposal 17
- Parameter settings
 - Calculated values (submenu) 45
 - Communication (submenu) 41
 - Device information (submenu) 60
 - Diagnostics (menu) 57
 - Low flow cut off (wizard) 43
 - Operation (submenu) 51
 - Partially filled pipe detection (wizard) 44
 - Process variables (submenu) 49
 - Sensor adjustment (submenu) 46
 - Simulation (submenu) 47
 - Totalizer (submenu) 50
- Performance characteristics 69
- Post-connection check (checklist) 29
- Post-installation check 39
- Post-installation check (checklist) 21
- Potential equalization 69
- Power consumption 68
- Power supply failure 69
- Pressure loss 73
- Pressure range
 - Secondary containment 73
- Pressure-temperature ratings 73
- Process connections 76
- Process variables
 - Calculated 66
 - Measured 66
- Product safety 9
- Protecting parameter settings 47
- R**
- Reading measured values 49
- Reading out diagnostic information, Modbus RS485 54
- Recalibration 62
- Reference operating conditions 69
- Registered trademarks 7
- Remote operation 76
- Repair 63
 - Notes 63
- Repair of a device 63
- Repeatability 70
- Replacement
 - Device components 63
- Requirements for personnel 8
- Response time 71
- Returning devices 63
- S**
- Safety 8
- Seals
 - Medium temperature range 73
- Sensor
 - Medium temperature range 73
 - Mounting 20
- Serial number 13, 14
- Service interface (CDI) 76
- Settings
 - Adapting the measuring device to the process conditions 50
 - Communication interface 41
 - Device reset 60
 - Device tag 39
 - Low flow cut off 43
 - Partial filled pipe detection 44
 - Resetting the totalizer 51
 - Sensor adjustment 46
 - Simulation 47
 - System units 39
 - Totalizer 46
 - Totalizer reset 51
- Shock resistance 72
- Signal on alarm 67
- Software release 35
- Spare part 63
- Spare parts 63
- Status signals 54
- Storage conditions 16
- Storage temperature 16
- Structure
 - Operating menu 31
- submenu
 - Calculated values 45
 - Communication 41
 - Device information 60
 - Operation 51
 - Process variables 49
 - Sensor adjustment 46
 - Simulation 47
 - Totalizer 50
 - Totalizer 1 to 3 46
- Submenu
 - Events list 58
 - Overview 32
 - Process variables 45
- Supply voltage 68
- System design
 - Measuring system 66
 - see Measuring device design
- System integration 35
- System pressure 19
- T**
- Technical data, overview 66
- Temperature range
 - Medium temperature 73
 - Storage temperature 16

Terminal assignment	24, 26
Terminals	69
Tools	
Electrical connection	22
Installation	20
Transport	16
Transmitter	
Connecting the signal cables	26
Transporting the measuring device	16
Troubleshooting	
General	52
U	
Use of the measuring device	
Borderline cases	8
Incorrect use	8
see Designated use	
User roles	32
V	
Version data for the device	35
Vibration resistance	72
Vibrations	20
W	
W@M	62, 63
W@M Device Viewer	12, 63
Weight	
SI units	74
Transport (notes)	16
US units	74
wizard	
Low flow cut off	43
Partially filled pipe detection	44
Workplace safety	9
Write protection	
Via write protection switch	48
Write protection switch	48

www.addresses.endress.com
