

# Operating Instructions

## Liquiphant FTL31

Point level switch for liquids

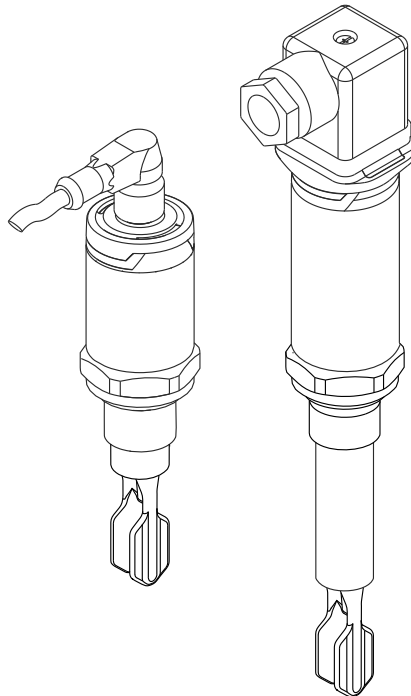

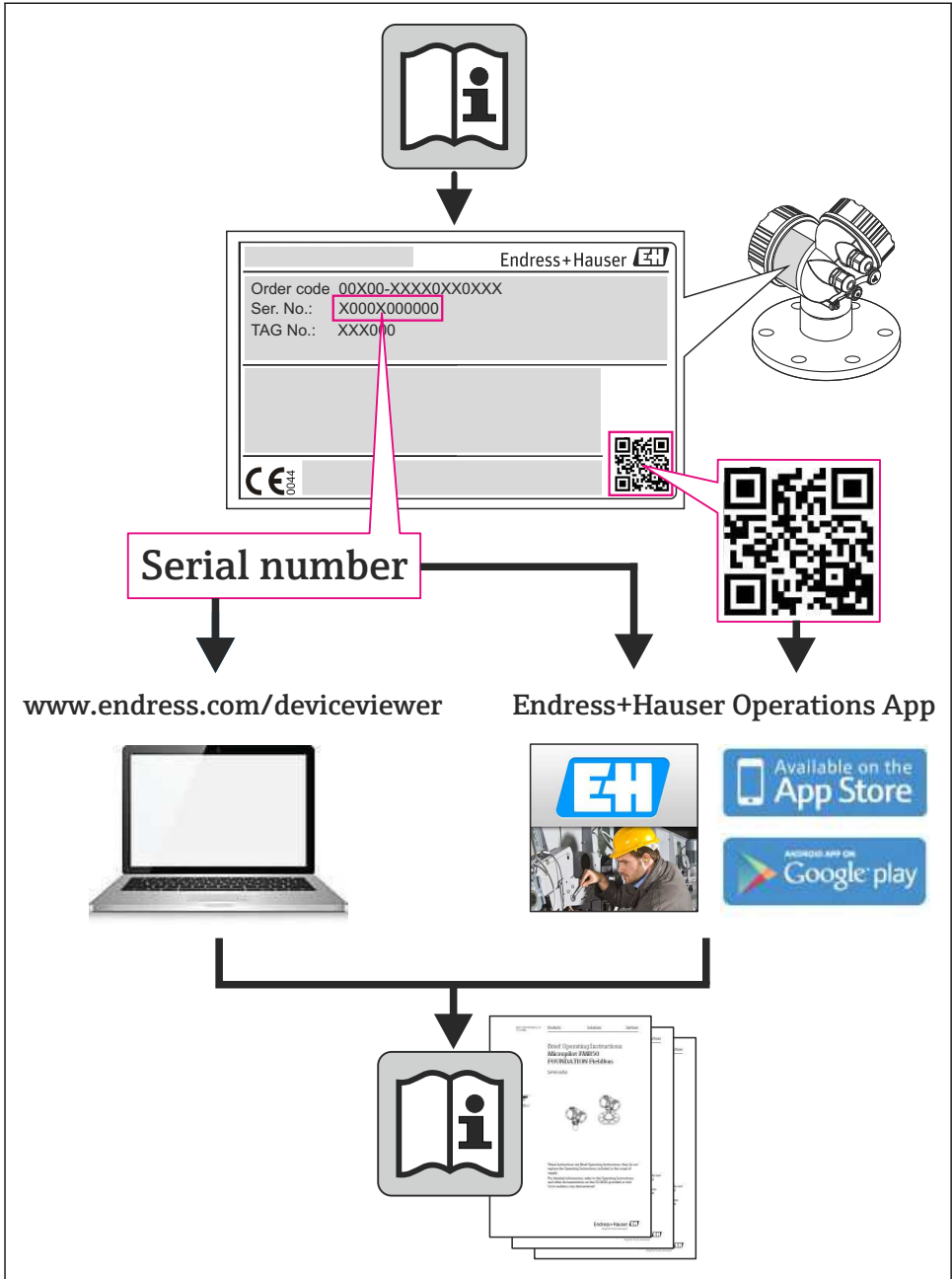

# Table of contents

<b>1 Document information</b> .....	<b>4</b>	10.3 Disposal .....	30
1.1 Document function .....	4	<b>11 Accessories</b> .....	<b>30</b>
1.2 Symbols .....	4	<b>12 Technical data</b> .....	<b>31</b>
1.3 Documentation .....	5	12.1 Power supply .....	31
<b>2 Basic safety instructions</b> .....	<b>6</b>	12.2 Environment .....	31
2.1 Requirements for the personnel .....	6	12.3 Process .....	33
2.2 Designated use .....	6		
2.3 Workplace safety .....	6		
2.4 Operational safety .....	7		
2.5 Product safety .....	7		
<b>3 Product description</b> .....	<b>8</b>		
3.1 Product design .....	8		
<b>4 Incoming acceptance and product identification</b> .....	<b>9</b>		
4.1 Incoming acceptance .....	9		
4.2 Product identification .....	10		
4.3 Storage and transport .....	10		
<b>5 Installation</b> .....	<b>12</b>		
5.1 Installation conditions .....	12		
5.2 Mounting the measuring device .....	18		
5.3 Post-installation check .....	19		
<b>6 Electrical connection</b> .....	<b>20</b>		
6.1 Connecting the device .....	20		
6.2 Post-connection check .....	25		
<b>7 Commissioning</b> .....	<b>26</b>		
7.1 Function check .....	26		
7.2 LED display .....	26		
7.3 Function test with test magnet .....	28		
<b>8 Diagnostics and troubleshooting</b> .....	<b>29</b>		
8.1 Diagnostic information via LED display .....	29		
<b>9 Maintenance</b> .....	<b>29</b>		
9.1 Cleaning .....	29		
<b>10 Repair</b> .....	<b>30</b>		
10.1 Spare parts .....	30		
10.2 Return .....	30		





# 1 Document information

## 1.1 Document function



These Operating Instructions contain all the information that is required in various phases of the life cycle of the device: from product identification, incoming acceptance and storage, to mounting, connection, operation and commissioning through to troubleshooting, maintenance and disposal.

## 1.2 Symbols



### 1.2.1 Safety instructions



Symbol	Meaning
 A0011189-EN	<b>DANGER!</b> This symbol alerts you to a dangerous situation. Failure to avoid this situation will result in serious or fatal injury.
 A0011190-EN	<b>WARNING!</b> This symbol alerts you to a dangerous situation. Failure to avoid this situation can result in serious or fatal injury.
 A0011191-EN	<b>CAUTION!</b> This symbol alerts you to a dangerous situation. Failure to avoid this situation can result in minor or medium injury.
 A0011192-EN	<b>NOTE!</b> This symbol contains information on procedures and other facts which do not result in personal injury.

### 1.2.2 Electrical symbols

Symbol	Meaning
 A0011200	<b>Ground connection</b> A grounded terminal which, as far as the operator is concerned, is grounded via a grounding system.
 A0011199	<b>Protective ground connection</b> A terminal which must be connected to ground prior to establishing any other connections.

### 1.2.3 Symbols for certain types of information

Symbol	Meaning
 A0011182	<b>Permitted</b> Indicates procedures, processes or actions that are permitted.
 A0011184	<b>Forbidden</b> Indicates procedures, processes or actions that are forbidden.

Symbol	Meaning
 A0011193	<b>Tip</b> Indicates additional information.
 A0011194	<b>Reference to documentation</b> Refers to the corresponding device documentation.
 A0011195	<b>Reference to page</b> Refers to the corresponding page number.

### 1.2.4 Symbols for graphics

Symbol	Meaning
1, 2, 3 ...	Item numbers
A, B, C, ...	Views

### 1.2.5 Symbols for tools

Symbol	Meaning
 A0011222	Open-ended wrench

## 1.3 Documentation

The document types listed are available in the Download Area of the Endress+Hauser website:  
[www.endress.com](http://www.endress.com) → [Download](#)

Document	Purpose and content of the document
Technical Information TI01147F/00/EN	This document contains all the technical data for the device and provides an overview of the accessories that can be ordered.
Additional documentation TI00426F/00/EN SD00352F/00/A6 SD00356F/00/EN	Weld-in adapter and flanges (overview) Weld-in adapter G 1", G ¾" (installation instructions) Valve plug (installation instructions)

## 2 Basic safety instructions

### 2.1 Requirements for the personnel

The personnel for installation, commissioning, diagnostics and maintenance must fulfill the following requirements:

- Trained, qualified specialists must have a relevant qualification for this specific function and task
- Are authorized by the plant owner/operator
- Are familiar with federal/national regulations
- Before beginning work, the specialist staff must have read and understood the instructions in the Operating Instructions and supplementary documentation as well as in the certificates (depending on the application)
- Following instructions and basic conditions

The operating personnel must fulfill the following requirements:

- Being instructed and authorized according to the requirements of the task by the facility's owner-operator
- Following the instructions in these Operating Instructions

### 2.2 Designated use

The measuring device described in these Operating Instructions may only be used as a level limit switch for liquids. Incorrect use may pose a hazard. To ensure that the measuring device remains in proper condition for the operation time:

- the measuring devices may only be used for media against which the process-wetted materials are adequately resistant.
- the limit values in "Technical Data" must be observed.

#### 2.2.1 Incorrect use

The manufacturer is not liable for damage caused by improper or non-designated use.

#### Residual risks

Heat transfer from the process can heat up the electronics housing and the modules it contains to up to 80 °C (176 °F) during operation.

Danger of burns from contact with surfaces!

- ▶ For elevated fluid temperature, ensure protection against contact to prevent burns.

### 2.3 Workplace safety

For work on and with the device:

- ▶ Wear the required personal protective equipment according to federal/national regulations.
- ▶ Switch off the supply voltage before connecting the device.

## 2.4 Operational safety

Risk of injury!

- ▶ Operate the device in proper technical condition and fail-safe condition only.
- ▶ The operator is responsible for interference-free operation of the device.

## 2.5 Product safety

This measuring device is designed in accordance with good engineering practice to meet state-of-the-art safety requirements, has been tested, and left the factory in a condition in which it is safe to operate. It meets general safety standards and legal requirements. It also complies with the EC directives listed in the device-specific EC Declaration of Conformity. Endress +Hauser confirms this by affixing the CE mark to the device.

## 3 Product description

The Liquiphant FTL31 is a point level switch for universal use in all liquids. It is used preferably in storage tanks, mixing vessels and pipes.

### 3.1 Product design

The point level switch is available in different versions which can be assembled in accordance with user specifications. Examples can be seen in the following diagram:

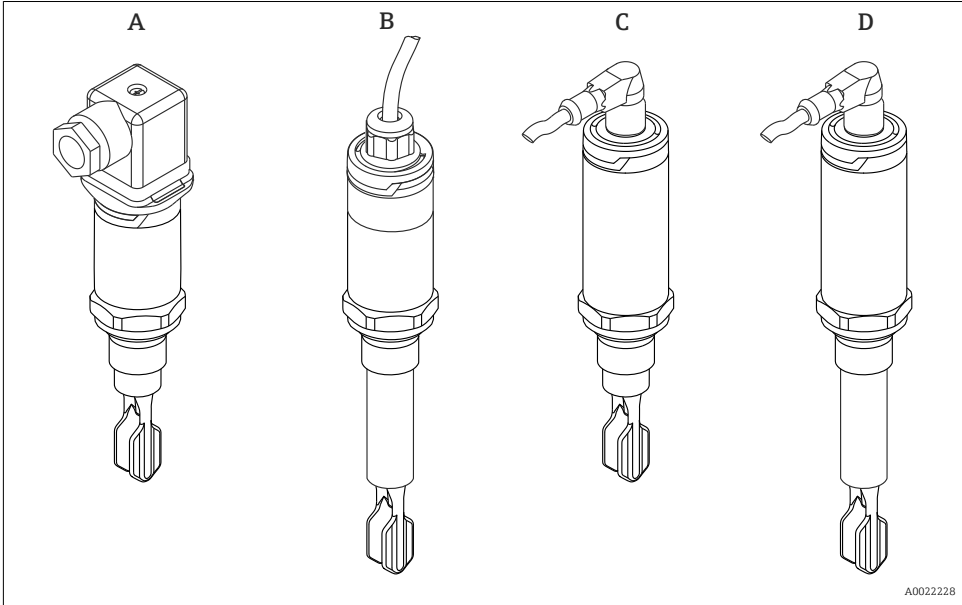

Versions	Examples			
	A	B	C	D
Electrical connection	Valve plug	Cable (cannot be dismantled)	M12 connector	M12 connector
Housing (sensor design) for process temperatures up to:	100 °C (212 °F)	100 °C (212 °F)	150 °C (302 °F)	150 °C (302 °F)
Sensor type	Compact version	Short tube version	Compact version	Short tube version



Detailed information on the short tube version and the process connections is available in Technical Documentation TI01147F/00/EN.



# 4 Incoming acceptance and product identification

## 4.1 Incoming acceptance



A0015502

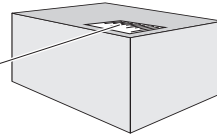

1 = 2

A0016051

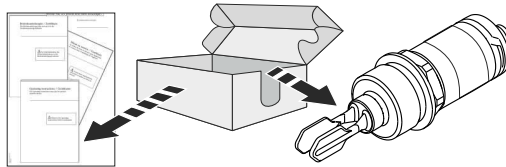

A0021096

Is the order code on the delivery note (1) identical to the order code on the product sticker (2)?



A0015502

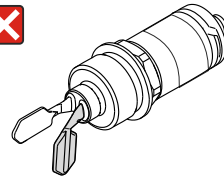
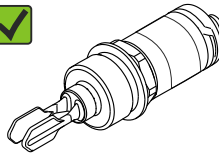

A0021097

Are the goods undamaged?



A0015502

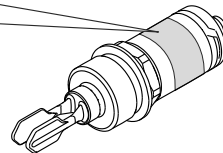
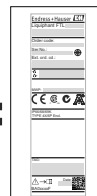

A0021098

Do the data on the nameplates correspond to the order specifications on the delivery note?



If one of these conditions is not met, please contact your Endress+Hauser sales office.

## 4.2 Product identification

The following options are available for identification of the measuring device:

- Nameplate data
- Order code with breakdown of the device features on the delivery note
- Enter serial number of nameplates in *W@M Device Viewer* ([www.endress.com/deviceviewer](http://www.endress.com/deviceviewer)): All information on the measuring device is displayed



An overview of the scope of the technical documentation supplied can be obtained by entering the serial number on the nameplate in *W@M Device Viewer* ([www.endress.com/deviceviewer](http://www.endress.com/deviceviewer))

### 4.2.1 Nameplate

The diagram shows a nameplate for an Endress+Hauser device. It contains the following fields and symbols:

- 1: Device name (Endress+Hauser)
- 2: Manufacturer's address
- 3: Order code
- 4: Serial number
- 5: Marking for test magnet (a circle with a crosshair)
- 6: Extended order code
- 7: Supply voltage (U:)
- 8: Signal output (I max.)
- 9: Process and ambient temperature
- 10: Process pressure
- 11: Certificate symbols (optional) (CE, SF, N12895, 74-06)
- 12: Degree of protection: e.g. IP, NEMA
- 13: Certificate- and approval-specific data
- 14: Measuring point identification (optional) (TAG:)
- 15: Date of manufacture (year, month) (Date:)
- 16: Data Matrix code
- 17: Document number of Operating Instructions (BAxxxxF)

A0021109

 The test magnet can be ordered as an accessory (→  30).

## 4.3 Storage and transport

### 4.3.1 Storage conditions

- Permitted storage temperature: -40 to +85 °C (-40 to +185 °F)
- Use original packaging.

### 4.3.2 Handling of the device

#### NOTICE

**Risk of injury! Housing or fork may become damaged or tear!**

- ▶ Transport the device to the measuring point in its original packaging or by the housing.
- ▶ Do not hold the device by the fork!
- ▶ Do not use the device as a ladder or climbing aid!
- ▶ Do not bend the fork!
- ▶ Do not shorten or lengthen the fork!

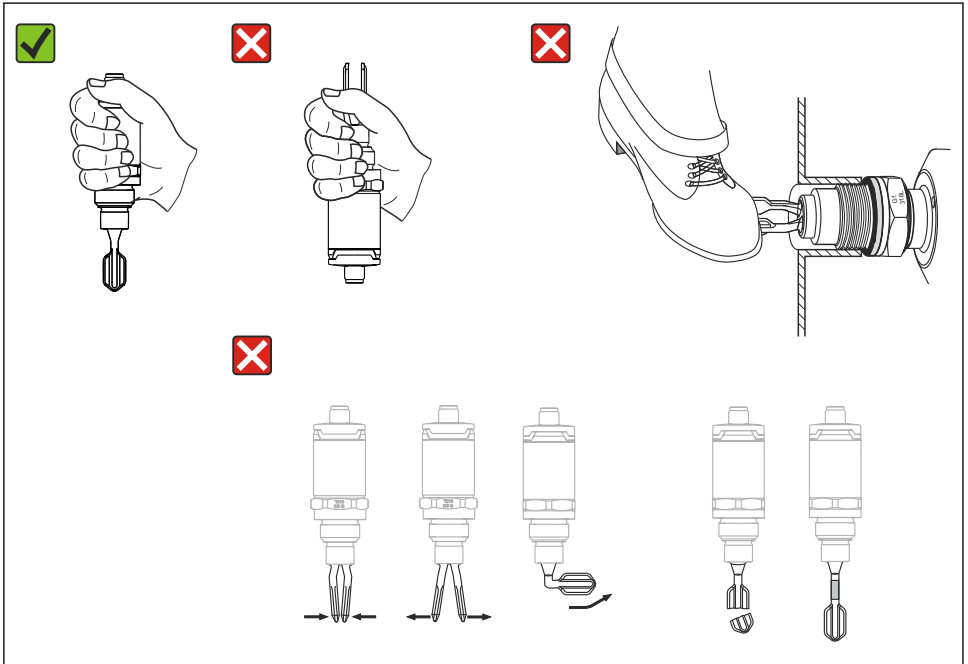

A0020845

1 Handling of the device

## 5 Installation

### 5.1 Installation conditions

#### 5.1.1 Orientation

The point level switch can be installed in any position in a vessel, pipe or tank.

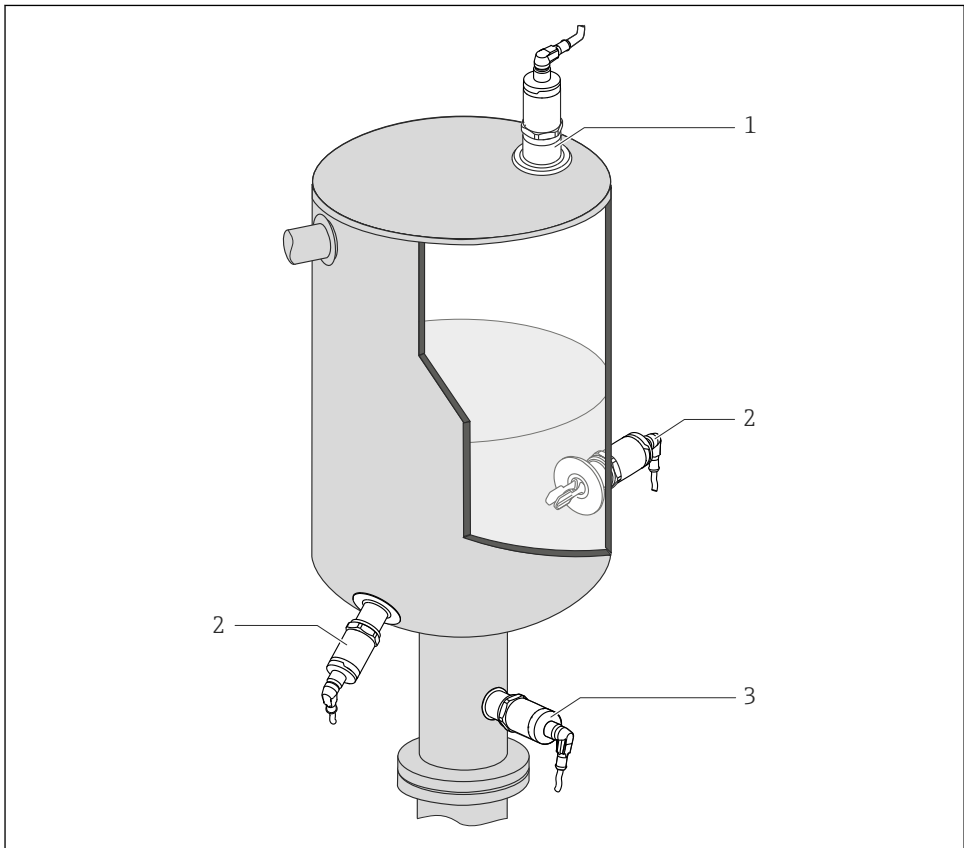

A0023118

#### 2 Installation options

- 1 Overfill prevention or upper level detection
- 2 Lower level detection
- 3 Dry running protection for pump

### 5.1.2 Switch point

The switch point (A) on the sensor depends on the orientation of the point level switch (water +25 °C (+77 °F), 1 bar (14.5 psi)).

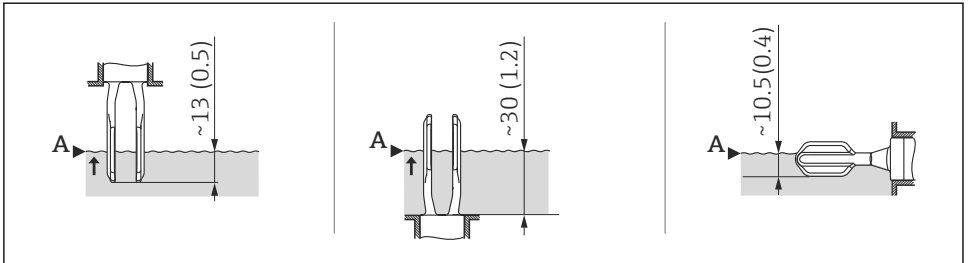

3 Vertical and horizontal orientation, dimensions in mm (in)

### 5.1.3 Viscosity

Switching delays may occur in the case of highly viscous liquids. Ensure that the liquid can easily run off the tuning fork:

- If installing in vessels with high-viscosity liquids (A), the tuning fork may **not** be located in the installation socket!
- If installing in vessels with low-viscosity liquids (B), the tuning fork may be located in the installation socket!
- The installation nozzle must be no less than the minimum diameter of 50 mm (2.0 in).

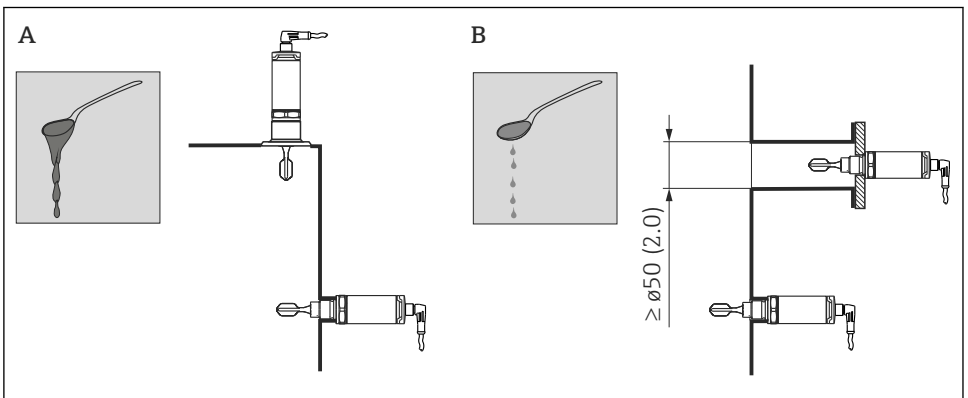

4 Installation options with consideration given to the liquid viscosity, dimensions in mm (in)

A High viscosity (< 10 000 mPa·s)

B Low viscosity (< 2 000 mPa·s)

### 5.1.4 Buildup

Make sure that the installation socket does not exceed a certain length so that the tuning fork can project freely into the vessel.

Possibilities for optimization:

- A vertical orientation of the point level switch keeps buildup to a minimum.
- Preferably flush-mounted on vessels or in pipes.

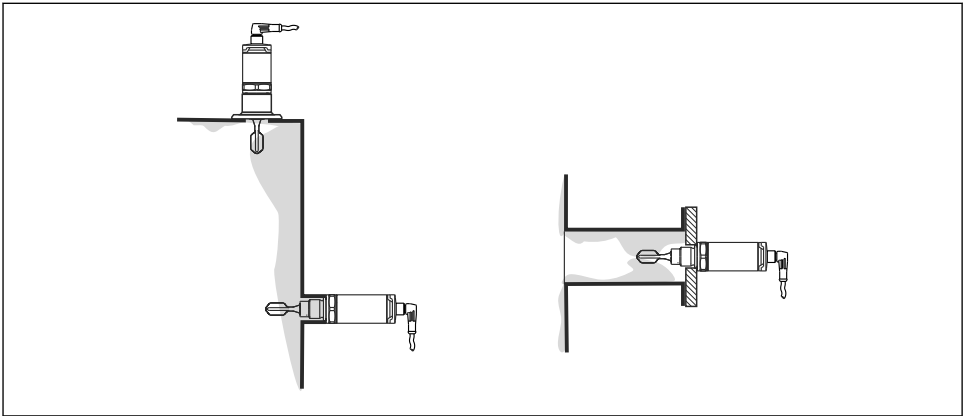

5 *Buildup on tank wall, pipe wall and tuning fork*

### 5.1.5 Weld-in adapter with leakage hole

If installed horizontally, ensure that the leakage hole is pointing down. This allows leaks to be detected as quickly as possible.

### 5.1.6 Marking

The marking indicates the position of the tuning fork. If installed horizontally in vessels, the marking is face up.

The marking appears either as a material specification (e.g. 316L) or a thread designation (e.g. G 1/2") in the following locations:

- On the hexagonal bolt of the process adapter
- On the nameplate
- On the weld-in adapter

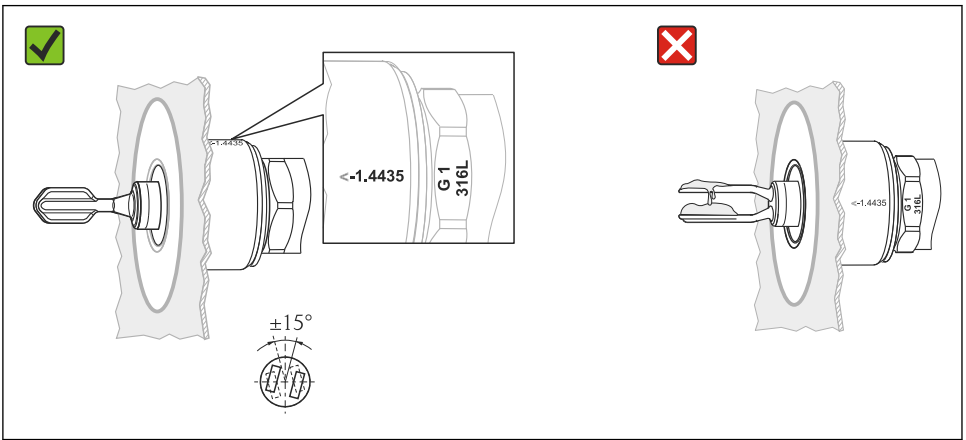

A0022641

6 Orientation in the vessel

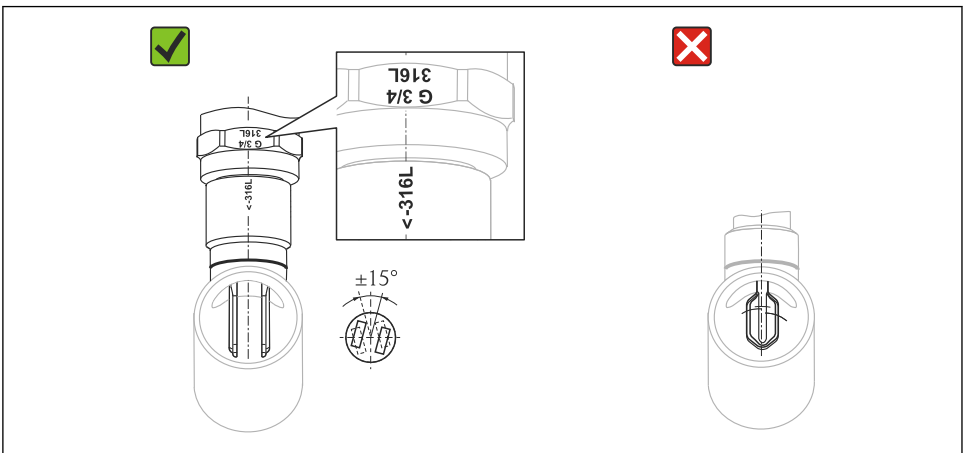

A0022804

7 Orientation in the pipe

### 5.1.7 Installation in pipes

During installation, pay attention to the position of the fork in order to minimize turbulence in the pipe.

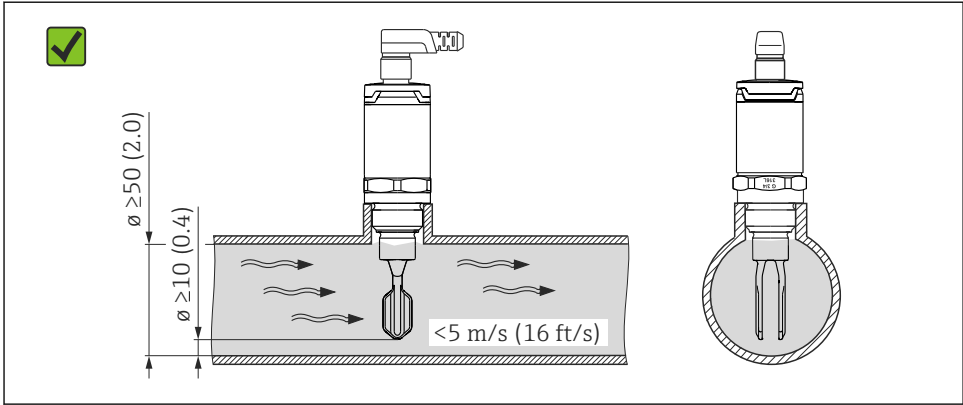

A0021357

Dimensions mm (in)

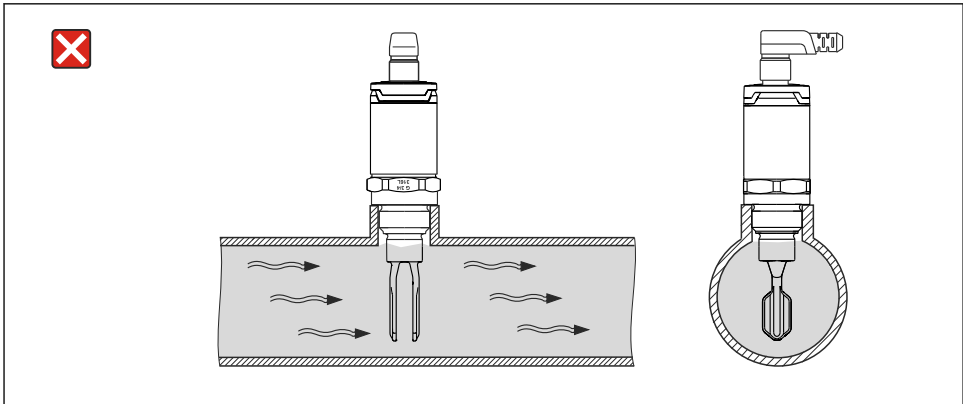



### 5.1.8 Installation in vessels

If installed horizontally, pay attention to the position of the tuning fork to ensure that the liquid can drip off easily.

The electrical connection, e.g. M12 connector, should be pointing down with the cable. This can prevent moisture from penetrating.

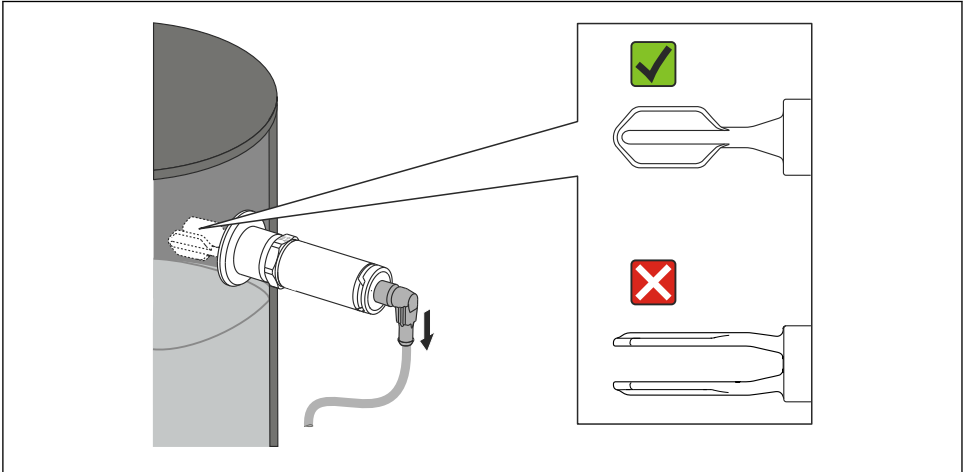

A0021034

8 Position of the fork in the case of horizontal installation in a vessel

### 5.1.9 Distance from wall

Ensure that there is sufficient distance between the expected buildup on the tank wall and the fork. Recommended distance from wall  $\geq 10$  mm (0.39 in).

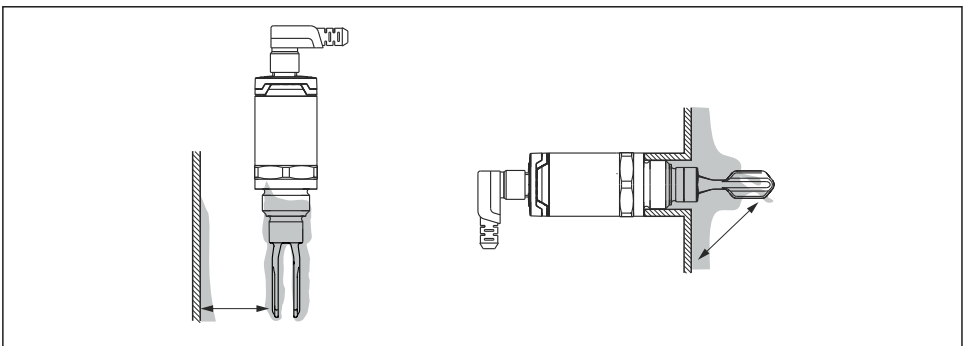

A0022272

## 5.2 Mounting the measuring device



**i** Service in accordance with WHG: Prior to mounting the device, pay attention to the WHG approval documents. The documents can be found in the Download Area of the Endress +Hauser website: [www.endress.com](http://www.endress.com) → [Download](#)

### 5.2.1 Required tools

- Open-ended wrench: only turn by the hex bolt when screwing in.  
Maximum torque: ≤ 30 Nm (22 lbf ft).
- Socket wrench: The socket wrench AF32 is available as an accessory (→  30).

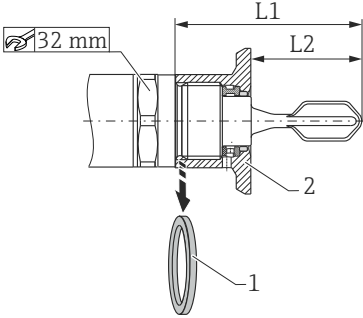
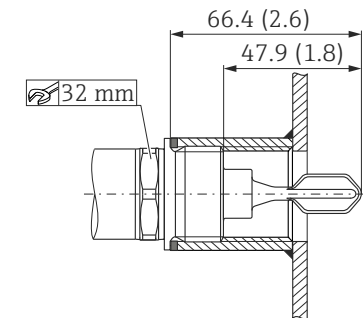
**i** Pay attention to the temperature and pressure specifications for seals used at the customer site.

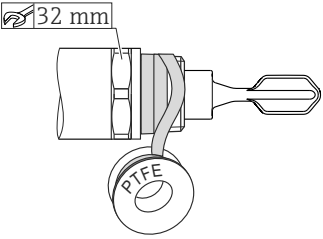
View, dimensions in mm (in)	Description
 <p>1 Flat seal 2 Weld-in adapter</p> <p>A0023245</p>	<p><b>Thread accessory weld-in adapter</b></p> <p><b>Example G 3/4" (example in graphic on left)</b></p> <ul style="list-style-type: none"> <li>▪ L1: 63.9 mm (2.52 in)</li> <li>▪ L2: 38.0 mm (1.5 in)</li> </ul> <p><b>G 1"</b></p> <ul style="list-style-type: none"> <li>▪ L1: 66.4 mm (2.61 in)</li> <li>▪ L2: 48.0 mm (1.89 in)</li> </ul> <p><b>Pressure and temperature (maximum):</b>                      +25 bar (+362 psi) at +150 °C (+302 °F)                      +40 bar (+580 psi) at +100 °C (+212 °F)</p> <p><b>i</b> When using a weld-in adapter with flush-mounted seal, the flat seal (1) supplied must be removed from the thread.</p>
 <p>A0022026</p>	<p><b>Metric thread in customer nozzle</b></p> <p><b>Example G 1"</b></p> <p><b>Pressure and temperature (maximum):</b>                      +40 bar (+580 psi) at 150 °C (302 °F)</p>

View, dimensions in mm (in)	Description
	<p><b>NPT thread (ANSI B 1.20.1)</b></p> <p><b>Pressure and temperature (maximum):</b> +40 bar (+580 psi) at +150 °C (+302 °F)</p> <p> Wrap in sealing material if necessary.</p>

### 5.3 Post-installation check

<input type="radio"/>	Is the device undamaged (visual inspection)?
<input type="radio"/>	<p>Does the device conform to the measuring point specifications?</p> <p>For example:</p> <ul style="list-style-type: none"> <li>▪ Process temperature</li> <li>▪ Process pressure</li> <li>▪ Ambient temperature</li> <li>▪ Switch point</li> </ul>
<input type="radio"/>	Are the measuring point identification and labeling correct (visual inspection)?
<input type="radio"/>	Is the device adequately protected from precipitation and direct sunlight?
<input type="radio"/>	Is the device secured properly?

## 6 Electrical connection

The device has two operating modes: maximum safety (MAX) and minimum safety (MIN). By choosing the corresponding operating mode, the user ensures that the device also switches in a safety-oriented manner even in an alarm condition, e.g. if the power supply line is disconnected.

### ■ Maximum safety (MAX)

The device keeps the electronic switch closed as long as the liquid level is below the fork.

Sample application: overflow prevention

### ■ Minimum safety (MIN)

The device keeps the electronic switch closed as long as the fork is immersed in liquid.

Sample application: Dry running protection for pumps

The electronic switch opens if the limit is reached, if a fault occurs or the power fails (quiescent current principle).

### 6.1 Connecting the device



 In accordance with IEC/EN61010 a separate circuit breaker must be provided for the device .

#### 6.1.1 Electronic version 3-wire DC-PNP

Voltage source: non-hazardous contact voltage or Class 2 circuit (North America)

#### M12 connector

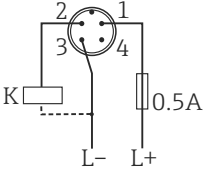
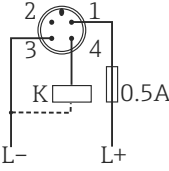
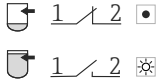
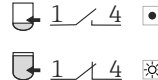
Depending on the analysis of the switch outputs, the device works in MAX oder MIN mode.

Electrical connection	Operating mode	
 <p>A0022901</p>	<p style="text-align: center;">MAX</p>  <p style="text-align: right;">A0022858</p>	<p style="text-align: center;">MIN</p>  <p style="text-align: right;">A0022859</p>
	 <p style="text-align: right;">A0021416</p>	 <p style="text-align: right;">A0021417</p>
<p>  Yellow LED (ye) not lit   Yellow LED (ye) lit                      K external load                 </p>		

*Function monitoring with M12 connector*

Using a two-channel analysis, function monitoring of the sensor can be implemented in addition to level monitoring, e.g. per relay switch, PLC, AS-i Bus I/O module, ...).

When both outputs are connected, the MIN and MAX outputs assume opposite states when the device is operating fault-free (XOR). In the event of an alarm condition or a line break, both outputs are deenergized.

Connection for function monitoring with antivalence		Yellow LED (ye)	Red LED (rd)
<p>A0022917</p>	<p><b>Sensor covered</b></p> <p>A0023016</p>	☼	•
	<p><b>Sensor exposed</b></p> <p>A0023029</p>	•	•
	<p><b>Fault</b></p> <p>A0023030</p>	•	☼
<p>☼ LED lit                  • LED not lit                  ⚡ Fault or warning                  K1 / K2 external load</p>			

### Valve plug, cable

Depending on the assignment of the connector or the wiring of the cable, the device works in either the MAX or MIN operating mode.

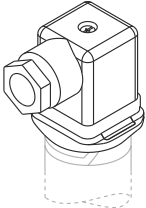
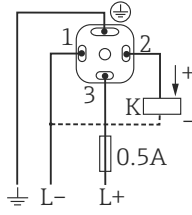
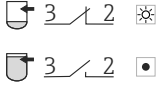
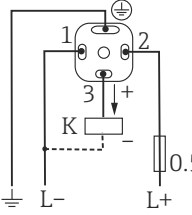
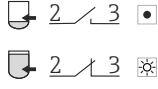
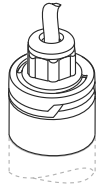
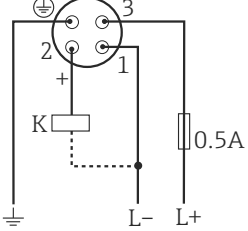
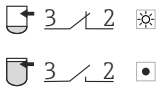
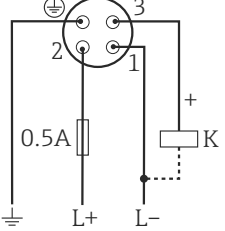
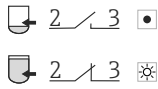
Electrical connection	Operating mode	
<p>Valve plug</p>  <p>A0022900</p>	<p>MAX</p>  <p>A0021724</p>  <p>A0021413</p>	<p>MIN</p>  <p>A0021723</p>  <p>A0021414</p>
<p>Cable</p>  <p>A0022902</p> <p>Core colors:                      1 = BK (black)                      2 = GR (gray)                      3 = BN (brown)                      Ground = GNYE (green-yellow)</p>	 <p>A0022226</p>  <p>A0021413</p>	 <p>A0022227</p>  <p>A0021414</p>
<p> <input type="checkbox"/> Yellow LED (ye) not lit  <input checked="" type="checkbox"/> Yellow LED (ye) lit                      K external load                 </p>		

### 6.1.2 Electronic version 2-wire AC/DC

Not suitable for connection to low-voltage PLC inputs!

#### Selection tool for relays

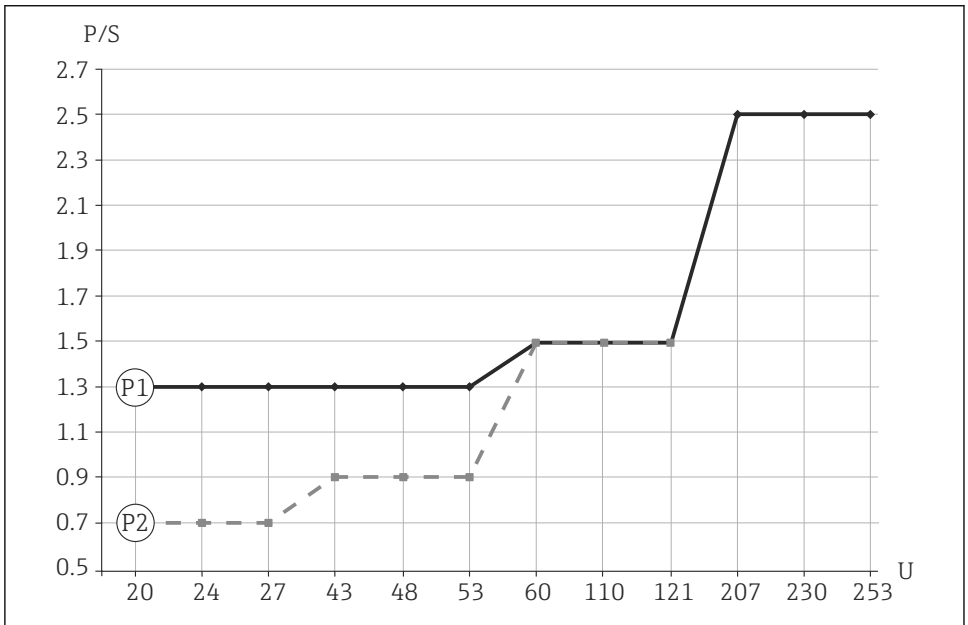

A0023486

9 Minimum rated power of the load

*P/S* Rated power in [W] / [VA]

*U* Operating voltage in [V]



Position	Supply voltage	Rated power	
		min	max
P1 AC mode	24 V	> 1.3 VA	< 6 VA
	110 V	> 1.5 VA	< 27.5 VA
	230 V	> 2.5 VA	< 57.5 VA
P2 DC mode	24 V	> 0.7 W	< 6 W
	48 V	> 0.9 W	< 12 W
	60 V	> 1.5 W	< 15 W

Relays with a lower rated power can be operated by means of an RC module connected in parallel (optional).

### Valve plug, cable

Depending on the assignment of the connector or the wiring of the cable, the device works in either the MAX or MIN operating mode.

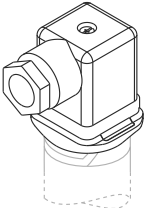
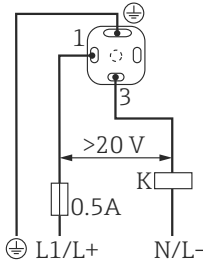
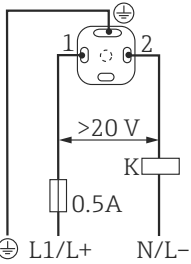
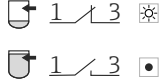
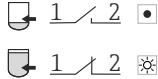
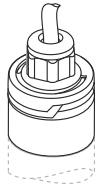
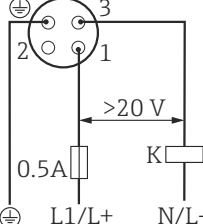
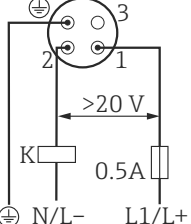
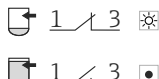
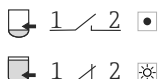
When the cable is wired, one wire of the cable does not have any function in each of the operating modes (gray in the case of MAX, and brown in the case of MIN). The cable with no function must be secured against inadvertent contact.

Electrical connection	Operating mode	
<p>Valve plug</p>  <p>A0022900</p>	<p>MAX</p>  <p>A0021219</p>	<p>MIN</p>  <p>A0021220</p>
	 <p>A0021418</p>	 <p>A0021420</p>
<p>Cable</p>  <p>A0022902</p>	 <p>A0022161</p>	 <p>A0022225</p>
<p>Core colors:                      1 = BK (black)                      2 = GR (gray)                      3 = BN (brown)                      Ground = GNYE (green-yellow)</p>	 <p>A0021418</p>	 <p>A0021420</p>
<p>  Yellow LED (ye) not lit   Yellow LED (ye) lit                      K external load                 </p>		



## 6.2 Post-connection check

<input type="radio"/>	Is the device or cable undamaged (visual check)?
<input type="radio"/>	Do the cables comply with the requirements ?
<input type="radio"/>	Do the cables have adequate strain relief?
<input type="radio"/>	Are the cable glands mounted and firmly tightened?
<input type="radio"/>	Does the supply voltage match the specifications on the nameplate?
<input type="radio"/>	Is the wiring correct?
<input type="radio"/>	3-wire DC-PNP: If required, is the functional earth connected?
<input type="radio"/>	2-wire C/DC: Has the protective ground connection been established?
<input type="radio"/>	If supply voltage is present, is the green LED lit?

## 7 Commissioning

### 7.1 Function check

Before commissioning your measuring point, ensure that the post-installation and post-connection checks have been performed.

- "Post-installation check" checklist (→ 📄 19)
- "Post-connection check" checklist (→ 📄 25)

**i** The function of the tuning fork can be easily tested by immersing the tuning fork in a vessel containing water.

### 7.2 LED display

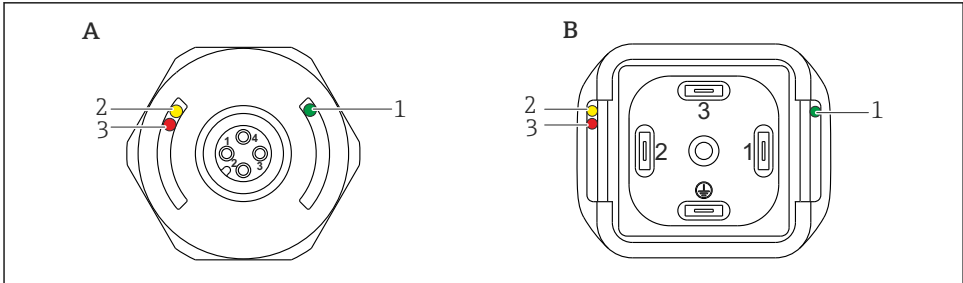

























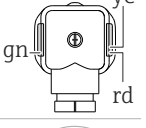

A0016856

A M12 connector, (cable without graphic)

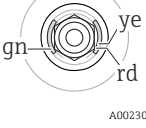
B Valve plug

Item	Function	Description
1	Green LED (gn) Lit	Device is operational
2	Yellow LED (ye) Lit	<p><b>M12 connector</b> Indicates the sensor state: tuning fork is covered by liquid</p> <p><b>Valve plug / cable</b> Indicates the switching state:</p> <ul style="list-style-type: none"> <li>▪ MAX operating mode (overflow prevention): sensor is <b>not</b> covered by liquid</li> <li>▪ MIN operating mode (dry running protection): the sensor is covered by liquid</li> </ul>
3	Red LED (rd) flashing Lit	<p>Warning/maintenance required: error can be rectified, e.g. incorrect wiring</p> <p>Fault/device failure: error cannot be rectified, e.g. electronic error</p>

### 7.2.1 Function of LEDs

Connection	Operating modes					
	Maximum safety (MAX)		Minimum safety (MIN)		Warning	Fault
1 						
2 						
3 						
4 						
	A0023004	A0023005	A0023006	A0023007	A0023008	A0023009
1: Level display 2: M12 connector 3: Valve plug 4: Cable			<ul style="list-style-type: none"> <li>● unlit</li> <li>☀ lit</li> <li>⚡ flashing</li> <li>⚡ fault/warning</li> </ul>			
LED colors: gn = green, ye = yellow, rd = red More information on LED display (→ 📖 26)						

## 7.3 Function test with test magnet

### **⚠ WARNING**

#### **Risk of injury!**

- ▶ Ensure that no dangerous processes are activated in the system.

To perform a function test, hold the test magnet against the marking on the nameplate (for at least 2 seconds). This inverts the current switching status and the yellow LED changes state. When the magnet is removed, the switching status valid at that time is adopted.

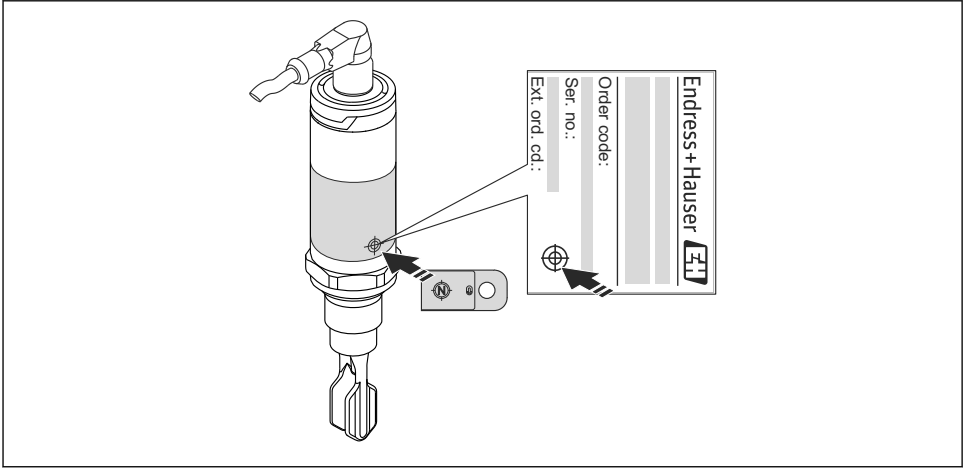

A0020960

#### **10** Test magnet and marking

**i** The test magnet is not included in the delivery and can be ordered as an optional accessory. (→ **30**)

## 8 Diagnostics and troubleshooting

### 8.1 Diagnostic information via LED display

*LED display on housing cover*

Malfunction	Possible cause	Corrective action
Green LED Unlit	No power supply	Check connector, cable and power supply
Red LED flashing	Overload or short-circuit in load circuit	<ul style="list-style-type: none"> <li>▪ Rectify short-circuit</li> <li>▪ Reduce maximum load current to below 250 mA</li> </ul>
Red LED Lit	Internal sensor failure or sensor corroded	Replace device

*Connection: 2-wire AC/DC to 20 to 253 V DC*

Malfunction	Possible cause	Corrective action
Unexpected behavior of yellow LED	Incorrect connector assignment or incorrect cable wiring	Pay attention to the polarity of the power supply!  <b>Correct connection:</b> Valve plug: L+ to PIN1, L- to PIN 3 Cable: L+ BK (black), L- BN (brown)  <b>Result</b> <ul style="list-style-type: none"> <li>▪ Tuning fork covered: yellow LED lit.</li> <li>▪ Tuning fork not covered: yellow LED <b>not</b> lit.</li> </ul>

## 9 Maintenance

No special maintenance work is required.

### 9.1 Cleaning

The sensor must be cleaned if necessary. It can also be cleaned while installed (e.g. CIP Cleaning in Place / SIP Sterilization in Place). Care must be taken to ensure that no damage occurs to the sensor in the process.

## 10 Repair

Repair is not envisaged for the point level switch.

### 10.1 Spare parts

The web site for the W@M Device Viewer ([www.endress.com/deviceviewer](http://www.endress.com/deviceviewer)): All spare parts for the measuring device are listed here together with the order code and can be ordered here. If available, users can also download the associated Installation Instructions.

### 10.2 Return

The measuring device must be returned if repairs or a factory calibration are required, or if the wrong measuring device has been ordered or delivered. According to legal regulations, Endress+Hauser, as an ISO-certified company, is required to follow certain procedures when handling returned products that are in contact with medium.



To ensure swift, safe and professional device returns, please read the return procedures and conditions on the Endress+Hauser website at [www.services.endress.com/return-material](http://www.services.endress.com/return-material)

### 10.3 Disposal

When disposing, separate and recycle the device components based on the materials.

## 11 Accessories

 Detailed information on accessories can be found in the technical documentation TI01147F.

Designation	Additional information
Weld-in adapter	 Detailed information on the weld-in adapters can be found in TI00426F/00/EN and in the supplementary documentation (→  5).
Seals, o-rings	
Plug-in jack M12 with cable 5 m (16 ft)	IP67, coupling nut (Cu Sn/Ni) <ul style="list-style-type: none"> <li>▪ Straight, order number: 52006263</li> <li>▪ Elbowed 90°, order number: 52010285</li> </ul>
Socket wrench for mounting	Hexagon bolt, AF32, order number: 52010156
Test magnet	Order number: 71267011

## 12 Technical data

 Further information on the technical data is provided in Technical Documentation TI01147F/00/EN.

### 12.1 Power supply

Electronic version	Supply voltage	Power consumption	Current consumption
3-wire DC-PNP	10 to 30 V DC	< 975 mW	< 15 mA
2-wire AC/DC	20 to 253 V	< 850 mW	< 3.8 mA

### 12.2 Environment

<b>Ambient temperature range</b>	-40 to +70 °C (-40 to +158 °F), see derating (→  32)
<b>Storage temperature</b>	-40 to +85 °C (-40 to +185 °F)
<b>Climate class</b>	DIN EN 60068-2-38/IEC 68-2-38: test Z/AD
<b>Altitude</b>	Up to 2 000 m (6 600 ft) above sea level
<b>Shock resistance</b>	a = 300 m/s <sup>2</sup> = 30 g, 3 planes x 2 directions x 3 shocks x 18 ms, as per test Ea, prEN 60068-2-27:2007
<b>Vibration resistance</b>	a(RMS) = 50 m/s <sup>2</sup> , ASD = 1.25 (m/s <sup>2</sup> ) <sup>2</sup> /Hz, f = 5 to 2000 Hz, t = 3 x 2 h, as per test Fh, EN 60068-2-64:2008
<b>Reverse polarity protection</b>	<p><b>2-wire AC/DC</b></p> <ul style="list-style-type: none"> <li>▪ AC mode: the device has reverse polarity protection.</li> <li>▪ DC mode: in the event of reverse polarity the maximum safety mode is always detected. Check the wiring and perform a function check before commissioning. The device is not damaged in the event of reverse polarity.</li> </ul> <p><b>3-wire DC-PNP</b></p> <p>Integrated. In the event of reverse polarity, the device is deactivated automatically.</p>
<b>Short-circuit protection</b>	<p><b>2-wire AC/DC</b></p> <p>During switching the sensor checks whether a load, e.g. relay or contactor, is present (load check). If an error occurs, the sensor is not damaged. Smart monitoring: normal operation is resumed once the error is fixed.</p> <p><b>3-wire DC-PNP</b></p> <p>Overload protection/short-circuit protection at I &gt; 250 mA; the sensor is not destroyed. Smart monitoring: check for overload in intervals of approx. 1.5 s; normal operation is resumed once the overload/short-circuit is fixed.</p>
<b>Degree of protection</b>	<ul style="list-style-type: none"> <li>▪ IP65/67 NEMA Type 4X Enclosure (M12 connector)</li> <li>▪ IP65 NEMA Type 4X Enclosure (valve plug)</li> <li>▪ IP66/68 NEMA Type 4X/6P Enclosure (cable)</li> </ul>
<b>Electromagnetic compatibility</b>	<p>Electromagnetic compatibility in accordance with all relevant requirements of the EN 61326 series and NAMUR recommendation EMC (NE21). For details, refer to the EC Declaration of Conformity.</p> <p>Available in the Download Area of the Endress+Hauser website: <a href="http://www.endress.com">www.endress.com</a>.</p>

### 12.2.1 Derating

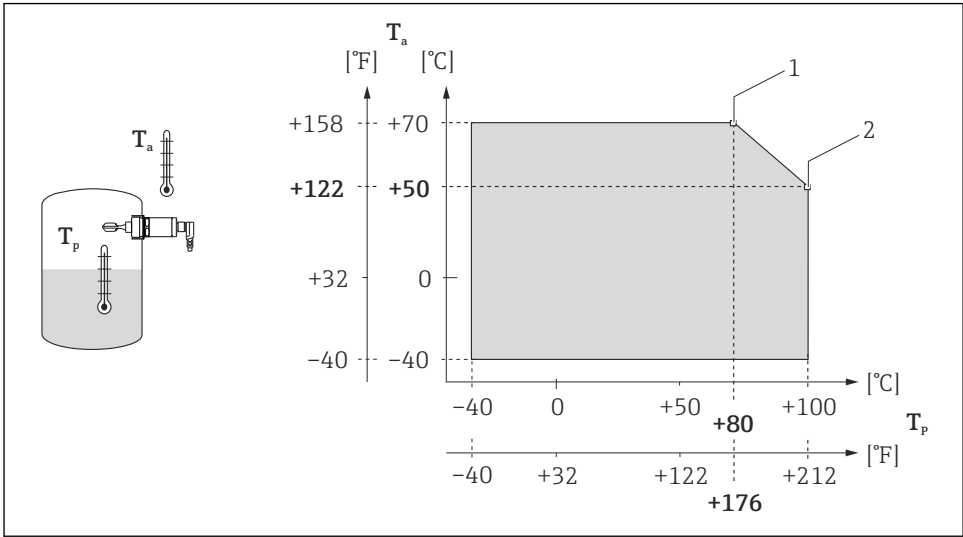

A0022002

11 Derating curve: 100 °C (212 °F)

1  $I_{max}$ : 200 mA (DC-PNP), 250 mA (AC/DC)

2  $I_{max}$ : 150 mA (DC-PNP), 150 mA (AC/DC)

Ta Ambient temperature

Tp Process temperature



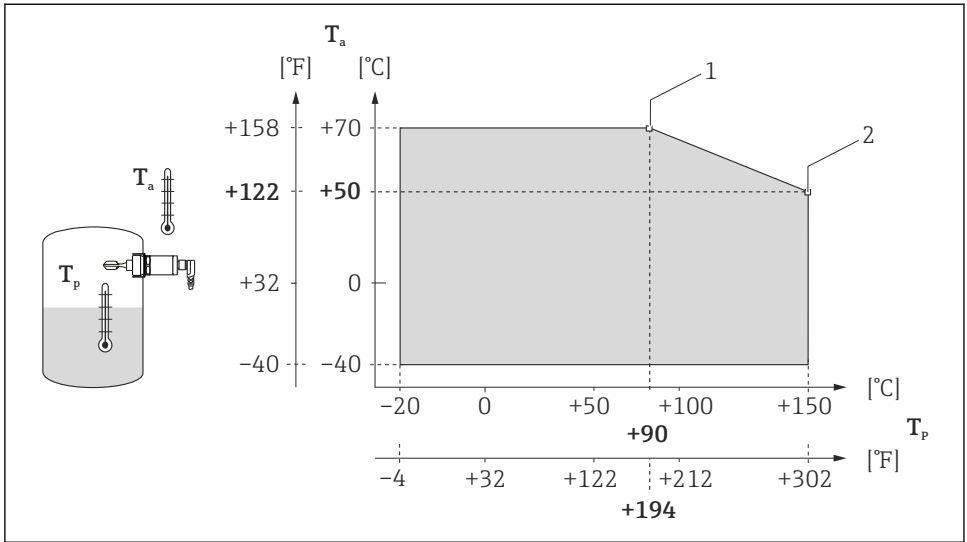

A0020869

12 Derating curve: 150 °C (302 °F)

1  $I_{max}$ : 200 mA (DC-PNP), 250 mA (AC/DC)

2  $I_{max}$ : 150 mA (DC-PNP), 150 mA (AC/DC)

$T_a$  Ambient temperature

$T_p$  Process temperature

## 12.3 Process

### NOTICE

- Pay attention to the pressure and temperature derating depending on the selected process connection .

Process temperature range	-40 to +100 °C (-40 to +212 °F) -40 to +150 °C (-40 to +302 °F)
Process pressure range	Max. -1 to +40 bar (-14.5 to +580 psi)
Density	> 0.7 g/cm <sup>3</sup> (optionally available: > 0.5 g/cm <sup>3</sup> )
State of aggregation	Liquid
Viscosity	1 to 10,000 mPa · s dynamic viscosity
Solids contents	ø < 5 mm (0.2 in)
Lateral loading capacity	Lateral loading capacity of the tuning fork: max. 200 N







71267730

[www.addresses.endress.com](http://www.addresses.endress.com)

---