



Level



Pressure



Flow



Temperature



Liquid  
Analysis



Registration



Systems  
Components



Services



Solutions

## Operating Instructions

# STIP-scan CAM74/CAS74

System for online measurement of nitrate,  $\text{COD}_{\text{eq}}$ ,  $\text{BOD}_{\text{eq}}$ ,  $\text{TOC}_{\text{eq}}$ , SAC, total solids, sludge volume, sludge index and turbidity



BA423C/07/en/05.09  
71087097

Valid from:  
Software version 19

**Endress+Hauser**

People for Process Automation



## Table of contents

<b>1</b>	<b>Safety instructions</b>	<b>4</b>	<b>6</b>	<b>Commissioning</b>	<b>59</b>
1.1	Designated use	4	6.1	Installation and functional check	59
1.2	Installation, commissioning and operation	4	6.2	Quick setup	59
1.3	Operational safety	4	6.3	Communication	60
1.4	Return	5	<b>7</b>	<b>Maintenance</b>	<b>64</b>
1.5	Notes on safety icons and symbols	5	7.1	Maintenance of complete measuring point	64
<b>2</b>	<b>Identification</b>	<b>6</b>	7.1.1	Cleaning the transmitter	64
2.1	Nameplate	6	7.1.2	Cleaning the sensor	64
2.1.1	Product structure for transmitter CAM74	7	7.1.3	Leakage test	65
2.1.2	Product structure for sensor CAS74	7	<b>8</b>	<b>Accessories</b>	<b>66</b>
2.2	Scope of delivery	8	<b>9</b>	<b>Troubleshooting</b>	<b>67</b>
2.3	Certificates and approvals	8	9.1	Warnings	67
<b>3</b>	<b>Installation</b>	<b>9</b>	9.2	Error messages	68
3.1	Incoming acceptance, transport, storage	9	9.3	Spare parts	69
3.2	Installation conditions	10	9.4	Return	69
3.3	Installation instructions	11	9.5	Disposal	69
3.3.1	Installation with upright post	11	<b>10</b>	<b>Technical Data</b>	<b>70</b>
3.3.2	Installing the sensor wall-bracket	13	10.1	Input	70
3.3.3	Installing the sensor	14	10.2	Output	70
3.3.4	Connecting the flow assembly	15	10.3	Power supply	70
3.4	Post-installation check	15	10.4	Performance characteristics	71
<b>4</b>	<b>Wiring</b>	<b>16</b>	10.5	Environment	71
4.1	Electrical connection	16	10.6	Process	71
4.2	Connecting sensor and transmitter (stainless steel version)	16	10.7	Mechanical construction	71
4.2.1	Electrical connection of transmitter	17	<b>Index</b>	<b>72</b>	
4.2.2	Connecting the signal outputs	18			
4.2.3	Connecting the relay outputs	19			
4.2.4	Connecting the panel PC	20			
4.3	Connecting sensor and transmitter (aluminum version)	20			
4.3.1	Electrical connection of transmitter	21			
4.3.2	Connecting the relay and signal outputs	23			
4.3.3	Connecting the PROFIBUS	23			
4.3.4	Connecting of the power	23			
4.4	Post-connection check	24			
<b>5</b>	<b>Operation</b>	<b>25</b>			
5.1	Human interface	25			
5.2	Onsite operation	26			
5.2.1	MEASUREMENT menu	26			
5.2.2	TRACES menu	29			
5.2.3	CALIBRATION menu	38			
5.2.4	SETTINGS menu	43			
5.2.5	TEST menu	54			
5.2.6	LANGUAGE menu	58			

# 1 Safety instructions

## 1.1 Designated use

STIP-scan is a system for online measurement of nitrate, COD<sub>eq</sub>, BOD<sub>eq</sub>, TOC<sub>eq</sub>, SAC, total solids, sludge volume, sludge index and turbidity.

The measuring system is particularly suitable for use in the following areas:

- Continuous monitoring of wastewater for organic pollution and/or nitrate
- Measurement of sludge parameters
- Special measurements in the spectral range from 200 to 680 nm

Any other use than the one described here compromises the safety of persons and the entire measuring system and is not permitted.

The manufacturer is not liable for damage caused by improper or non-designated use.

## 1.2 Installation, commissioning and operation

Please note the following items:

- Installation, commissioning, operation and maintenance of the measuring system must only be carried out by trained technical personnel.  
Trained personnel must be authorized for the specified activities by the system operator.
- Electrical connection must only be carried out by a certified electrician.
- Technical personnel must have read and understood these Operating Instructions and must adhere to them.
- Before commissioning the entire measuring point, check all the connections. Ensure that electrical cables and hose connections are not damaged.
- Do not operate damaged products and secure them against unintentional commissioning. Mark the damaged product as being defective.
- Measuring point faults may only be rectified by authorized and specially trained personnel.
- If faults can not be rectified, the products must be taken out of service and secured against unintentional commissioning.
- Repairs not described in these Operating Instructions may only be carried out at the manufacturer's or by the service organization.

## 1.3 Operational safety

The assembly has been designed and tested in accordance with the latest industry standards and left the factory in perfect functioning order.

Relevant regulations and standards have been met.

As the user, you are responsible for complying with the following safety conditions:

- Installation instructions
- Local prevailing standards and regulations.

### **Immunity to interference**

This instrument has been tested for electromagnetic compatibility in industrial use according to applicable European standards.

Protection against interference as specified above is valid only for an instrument connected according to the instructions in these Operating Instructions.

## 1.4 Return

If a repair is needed, please *clean* the sensor and return it to your sales office. When returning the item, please use the original packaging.

Please enclose the completed "Declaration of hazardous material and de-contamination" (copy the second last page of these Operating Instructions) in the packaging together with the dispatch documents. No repairs can be carried out without a completed declaration!

## 1.5 Notes on safety icons and symbols



**Warning!**

This symbol alerts you to hazards that can cause serious damage to the instrument or to persons if ignored.



**Caution!**

This symbol alerts you to possible faults which could arise from incorrect operation. They could cause damage to the instrument if ignored.



**Note!**

This symbol indicates important items of information.

### Electrical symbols



**Direct Current (DC)**

A terminal at which DC is applied or through which DC flows.



**Alternating Current (AC)**

A terminal at which (sine-form) AC is applied or through which AC flows.



**Ground connecting**

A terminal which, from the user's point of view, is already grounded using a grounding system.



**Protective ground terminal**

A terminal which must be grounded before other connections may be set up.



**Alarm relay**



**Input**



**Output**



**DC voltage source**



**Temperature sensor**

## 2 Identification

### 2.1 Nameplate

Compare the order code on the nameplate (transmitter and sensor) with the product structure and your order.

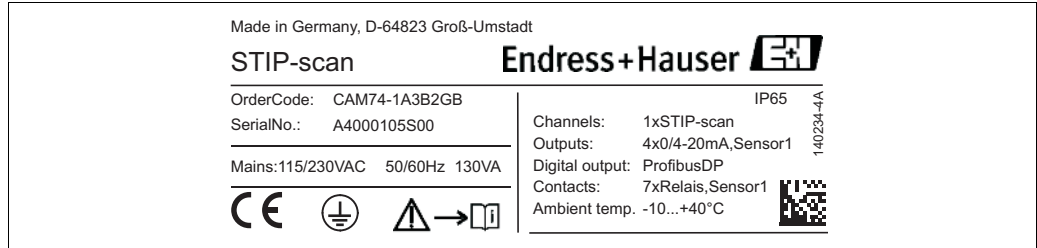

Fig. 1: Nameplate of transmitter (example)

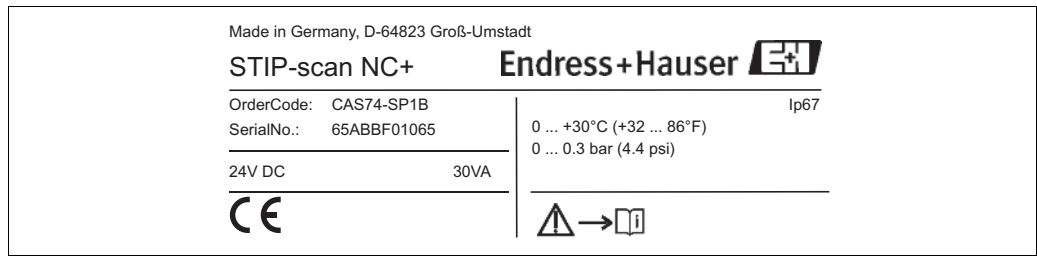

Fig. 2: Nameplate of sensor (example)

### 2.1.1 Product structure for transmitter CAM74

				<b>Sensor input</b>	
	<b>1</b>	1x STIP-scan			
	<b>2</b>	2x STIP-scan			
				<b>Power supply</b>	
	<b>A</b>	115/230 V; 50/60 Hz			
	<b>B</b>	100 to 250 V; 50 to 60 Hz			
				<b>Analog output</b>	
	<b>1</b>	Not selected			
	<b>2</b>	2x 0/4 to 20 mA; sensor 1 (not with CAM74-2*****)			
	<b>3</b>	4x 0/4 to 20 mA; sensor 1 (not with CAM74-2*****)			
	<b>4</b>	4x 0/4 to 20 mA; sensor 1 + 2 (not with CAM74-1*****)			
	<b>5</b>	8x 0/4 to 20 mA; sensor 1 + 2 (not with CAM74-1*****)			
				<b>Digital output</b>	
	<b>A</b>	Not selected			
	<b>B</b>	PROFIBUS DP (not with CAM74-2*****)			
				<b>Additional contacts</b>	
	<b>1</b>	Not selected			
	<b>2</b>	7x relay; sensor 1 (not with CAM74-2*****)			
	<b>3</b>	14x relay; sensor 1 + 2 (not with CAM74-1*****)			
				<b>Display</b>	
	<b>G</b>	Stainless steel version, Graphical, touch screen PC			
	<b>H</b>	Aluminum version, Graphical, touch screen PC			
				<b>Accessories</b>	
	<b>A</b>	Not selected			
	<b>B</b>	1 x sensor wall mounting + transmitter wall mounting			
	<b>C</b>	2 x sensor wall mounting + transmitter wall mounting			
	<b>D</b>	1 x sensor stand + transmitter wall mounting			
	<b>E</b>	2 x sensor stand + transmitter wall mounting			
	<b>F</b>	1 x stand for sensor and transmitter			
	<b>G</b>	1 x stand for sensor + 1 x stand for sensor and transmitter			
	<b>H</b>	Weather protection cover + 1 x stand for sensor and transmitter (not with CAM74-*A*****)			
CAM74-					complete order code

### 2.1.2 Product structure for sensor CAS74

				<b>Measuring parameter</b>	
	<b>NI</b>	Nitrate			
	<b>NS</b>	Nitrate + SAC + COD/BOD/TOC equivalent			
	<b>SA</b>	SAC + COD/TOC equivalent			
	<b>SP</b>	Spectrum + Nitrate + SAC + COD/BOD/TOC equivalent			
				<b>Sensor holder</b>	
	<b>0</b>	Not selected (replacement sensor)			
	<b>1</b>	0.5 m + 5 m (1.64 ft + 16.4 ft) cable			
	<b>2</b>	0.5 m + 10 m (1.64 ft + 32.8 ft) cable			
	<b>3</b>	0.5 m + 20 m (1.64 ft + 65.6 ft) cable			
	<b>4</b>	1.5 m + 5 m (4.92 ft + 16.4 ft) cable			
	<b>5</b>	1.5 m + 10 m (4.92 ft + 32.8 ft) cable			
	<b>6</b>	1.5 m + 20 m (4.92 ft + 65.6 ft) cable			
				<b>Assembly</b>	
	<b>A</b>	Not selected			
	<b>B</b>	Flow through chamber			
CAS74-					complete order code

## 2.2 Scope of delivery

The following are included in the scope of supply of the measuring system:

- Sensor holder
- Sensor
- Data cable
- Transmitter
- Air pump
- Operating Instructions

If you have any questions, please contact your supplier or your local sales center.

## 2.3 Certificates and approvals

### **Declaration of conformity**

The product meets the requirements of the harmonized European standards. It thus complies with the legal requirements of the EC directives.

The manufacturer confirms successful testing of the product by affixing the **CE** symbol.



## 3 Installation

### 3.1 Incoming acceptance, transport, storage

- Make sure the packaging is undamaged!  
Inform the supplier about any damage to the packaging.  
Keep the damaged packaging until the matter has been settled.
- Make sure the contents are undamaged!  
Inform the supplier about damage to the contents. Keep the damaged products until the matter has been settled.
- Check that the order is complete and agrees with your shipping documents.
- The packaging material used to store or to transport the product must provide shock protection and humidity protection. The original packaging offers the best protection. Also, keep to the approved ambient conditions (see "Technical data").
- If you have any questions, please contact your supplier or your local sales center.

### 3.2 Installation conditions



Note!

Install the sensor at a stand with supporting arms or at a wall bracket with supporting arms. Do not install the sensor suspended from the connection cable!

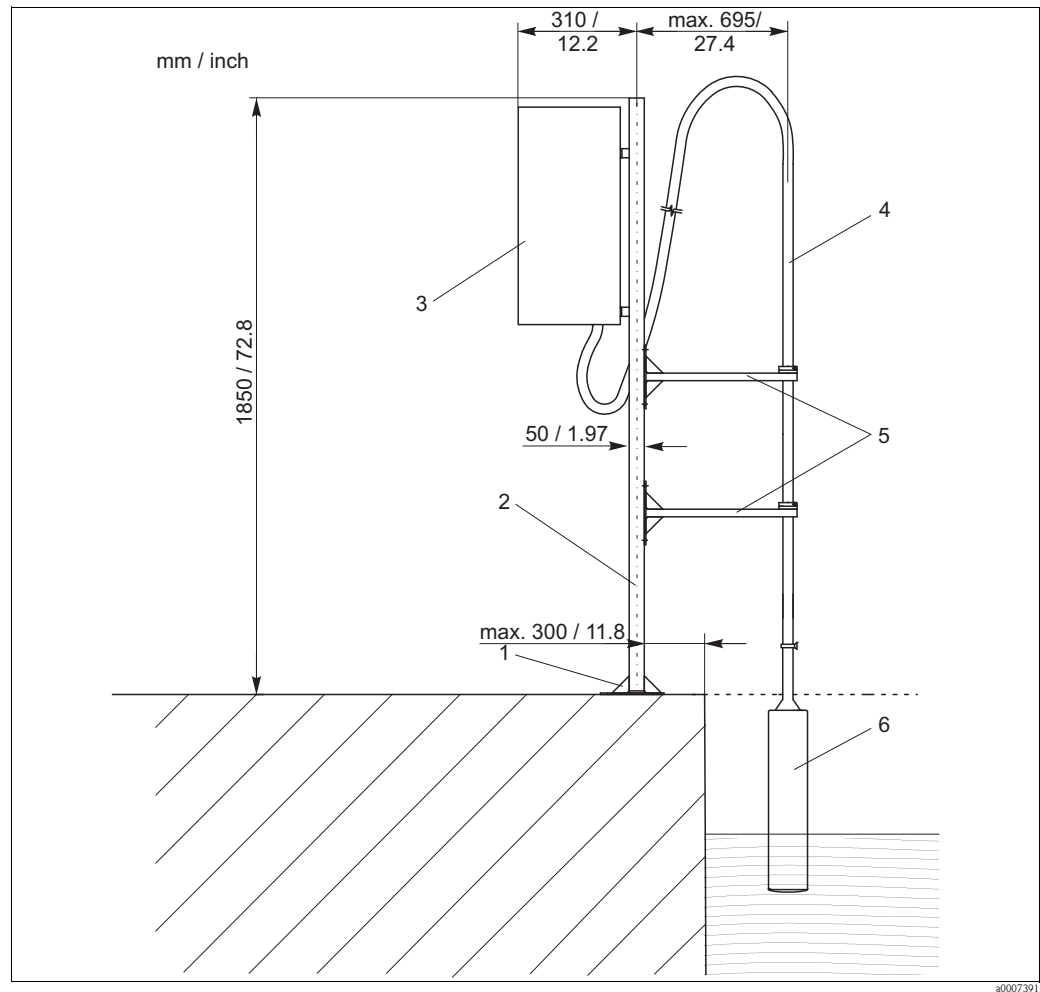

Fig. 3: Stand with supporting arms

- 1 Base plate
- 2 Stand
- 3 Transmitter CAM74 in weather protection housing
- 4 Connection cable with supporting pipe
- 5 Supporting arms
- 6 STIP-scan sensor CAS74

### 3.3 Installation instructions

#### 3.3.1 Installation with upright post

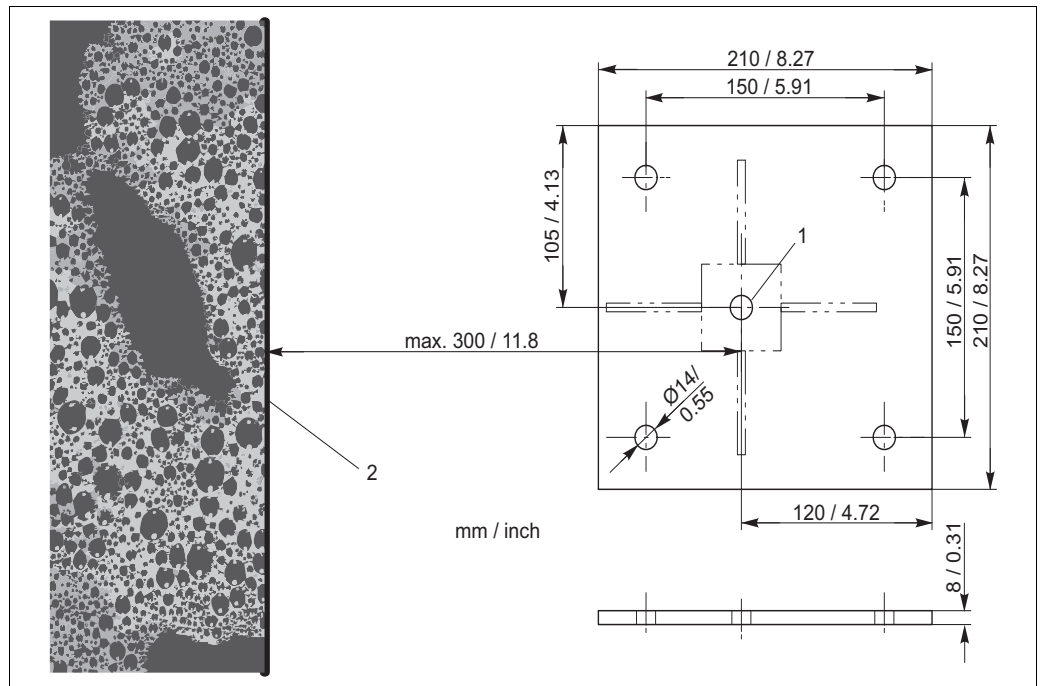

Fig. 4: Dimensions of baseplate

- 1 Midpoint of post
- 2 Basin rim



#### Note!

Use M12 chemical anchors to mount the upright post on a concrete base.

To mount the upright post, proceed as follows:

1. Move the upright post into position. The midpoint of the post must be at a maximum distance of 300 mm (11.8 inch) from the basin rim.
2. Draw the anchor holes for the baseplate onto the base.
3. Drill the anchor holes using a 14 mm drill bit.
4. Install the four chemical anchors.
5. Screw the baseplate on tightly.
6. Ground the upright post using a grounding cable ( $\geq 4 \text{ mm}^2$  ( $\geq 12 \text{ AWG}$ )).

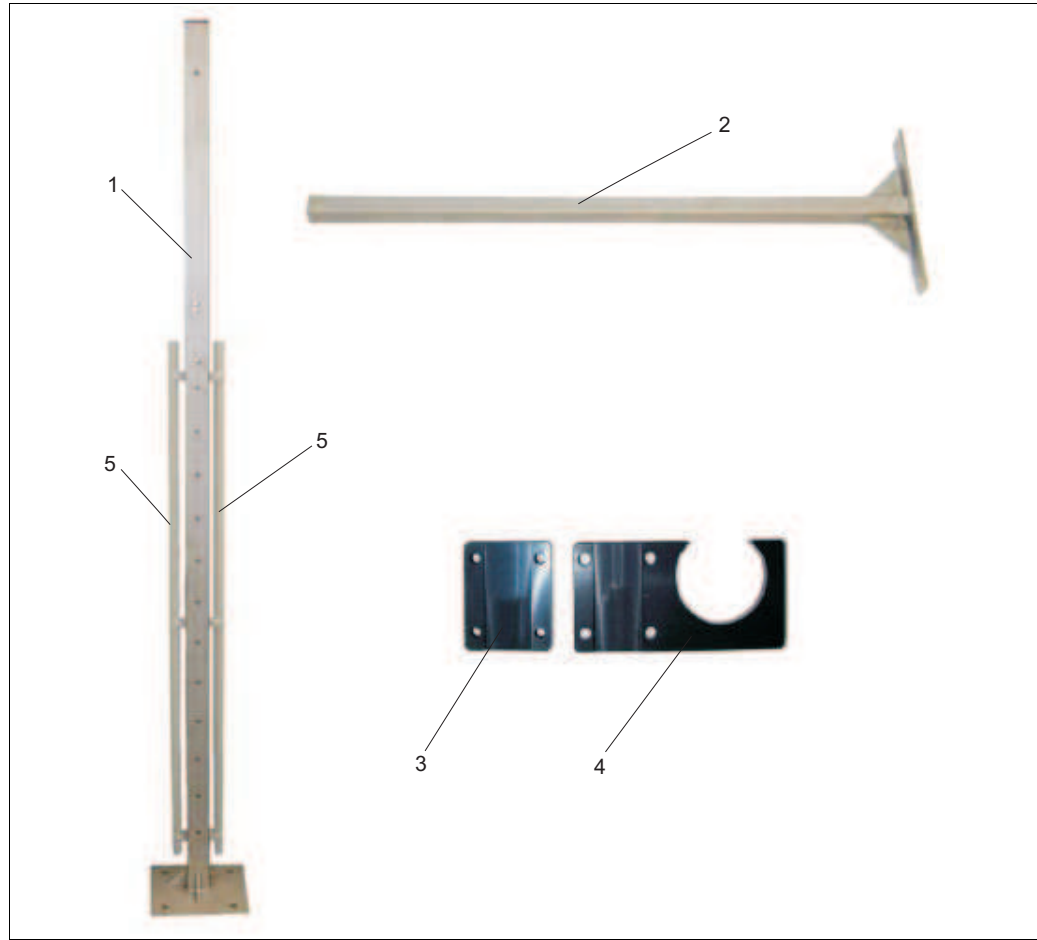

Fig. 5: Upright post with accessories

- 1 Upright post
- 2 Supporting arm
- 3 Back support
- 4 Sensor holder
- 5 Cable conduit

To install the accessories, proceed as follows:

1. Attach both cable conduits (pos. 5) to the upright post.
2. Screw two supporting arms (pos. 2) into the upright post.  
When doing so, please note the following installation conditions:
  - Distance between the supporting arms when a short support tube is used: 25 to 35 cm (0.82 to 1.15 ft.)
  - Distance between the supporting arms when a long support tube is used: 40 to 100 cm (1.3 to 3.3 ft.)
  - Maximum immersion depth of sensor: 50 cm (1.6 ft.)
3. Attach a sensor holder with back support (pos. 3 + 4, Abb. 5) to each of the two supporting arms.

If you install the stainless steel version of the transmitter follow the steps 4 and 5:

4. Screw the two support tubes of the panel PC into the center of the upright post (M10x90).
5. Screw the weatherproof housing into the external bores of the two support tubes (M10x40).

If you install the aluminum version of the transmitter proceed as follows:

1. Screw the mounting bracket and the weather protection roof (if applicable) with two screws M8 to the upright post.
2. Install the transmitter in the mounting bracket. At first use only the center screws on both sides.
3. Select the desired viewing angle (3 positions are selectable).
4. Screw in the remaining screws.

### 3.3.2 Installing the sensor wall-bracket

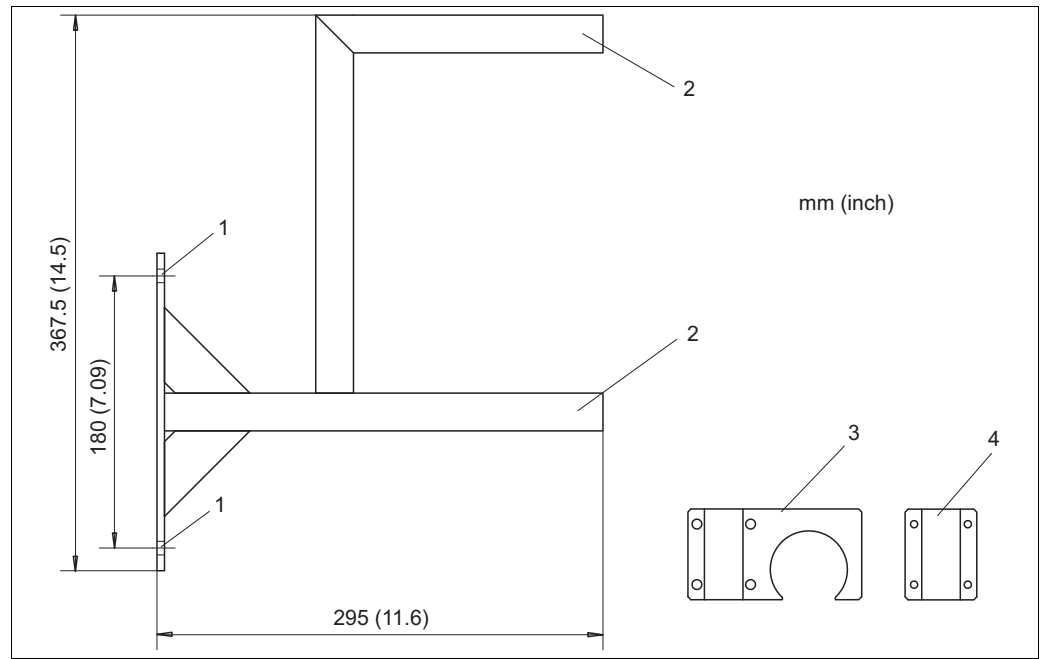

Fig. 6: Wall bracket

- 1 Anchor holes for wall bracket (mounting parts: 2x hex head screw 10x80, 2x wall plug 14x75 and 2x washer 10.5)
- 2 Mounting the sensor holder (mounting parts: 2x sensor holder, 2x back support and 8x Allen screw M6x40)
- 3 Sensor holder
- 4 Back support

Mount the wall bracket as follows:

1. Screw the wall bracket into the desired position.
2. Attach the sensor holder to the two support tubes.
3. Close the pipe openings using caps.

### 3.3.3 Installing the sensor



Note!

Note the maximum immersion depth of 550 mm (21.7")

To install the sensor, proceed as follows:

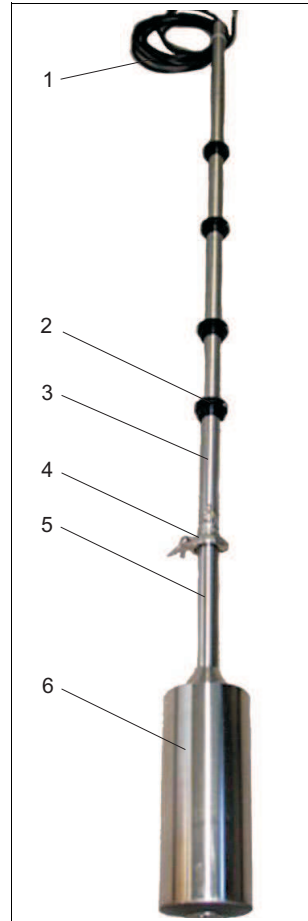

a0010004

Fig. 7: Sensor on connecting line

- 1 Control line
- 2 Clamping ring
- 3 Support tube
- 4 Connecting clip
- 5 Carrier tube
- 6 Sensor housing

1. Put the sensor on the sensor stand on an even surface .
2. Open the connecting clip and remove the cap.
3. Place the seal in the direction of the arrow on the sealing surface of the carrier tube.
4. Pull the connector slightly out of the carrier tube, and attach the connector to the connecting socket of the support tube.
5. Secure the connection using the screw sleeve.
6. Put the support tube onto the carrier tube, and secure the flange connection using the tension clip.
7. Use the clamping rings to adjust the measuring position (immersion depth) and the service position.
8. Attach the support tube of the sensor to the supporting arms of the upright post.

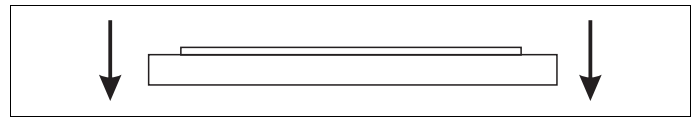

a0010006

Fig. 8: Seal

### 3.3.4 Connecting the flow assembly

The flow assembly is already fitted to the sensor.

Install the flow assembly connections in such a way that air bubbles cannot form in the area of the flow assembly.

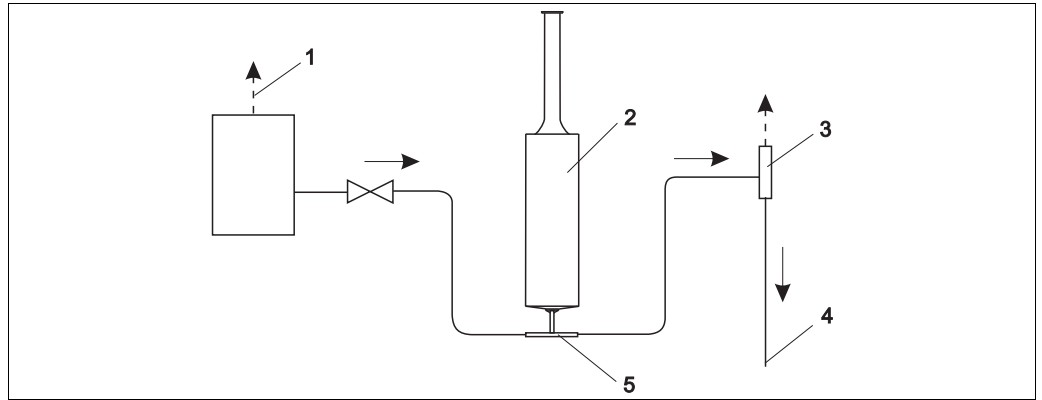

Fig. 9: Connecting the flow assembly

- 1 Inlet ventilation
- 2 Sensor
- 3 Outlet ventilation
- 4 Outlet
- 5 Flow assembly

### 3.4 Post-installation check

- After mounting, check all the connections to ensure they are secure and leak-tight.
- Check all cables and hoses for damage.
- Check whether the cables are routed such that they are free from electromagnetic interference influences.

## 4 Wiring

### 4.1 Electrical connection



Warning!

- The electrical connection must only be carried out by a certified electrician.
- Technical personnel must have read and understood the instructions in this manual and must adhere to them.
- Ensure that there is no voltage at the power cable before beginning the connection work.

### 4.2 Connecting sensor and transmitter (stainless steel version)

Connect the sensor and the transmitter as follows:

1. Ground the upright post or the wall bracket.
2. Install the connecting cable between the sensor and transmitter.
3. If the transmitter is equipped with signal outputs, connect the analog modules.
4. If the transmitter is equipped with relay outputs, connect the relay modules.
5. If the transmitter is equipped with a PROFIBUS card, connect the fieldbus cable to the panel PC.
6. Connect the power cable to your power supply.

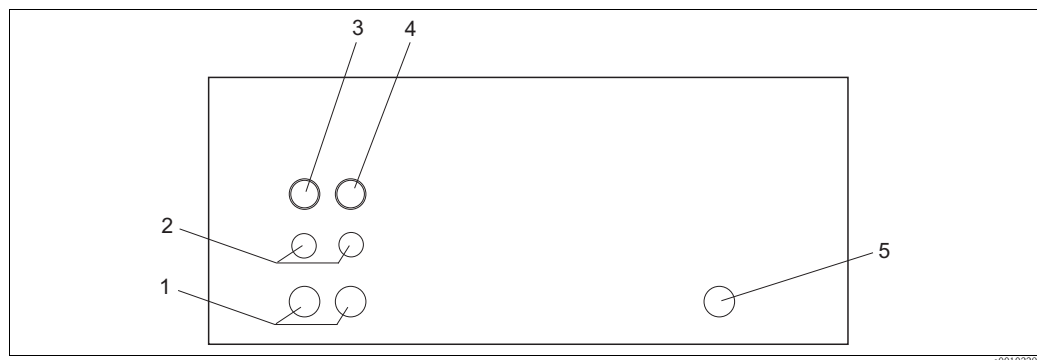

Fig. 10: Cable connections at the weatherproof housing (underside)

- 1 Cable bushing, large (Pg threaded connection)
- 2 Cable bushing, small (Pg threaded connection)
- 3 Connection, sensor 1
- 4 Connection, sensor 2
- 5 Power cable



### 4.2.1 Electrical connection of transmitter

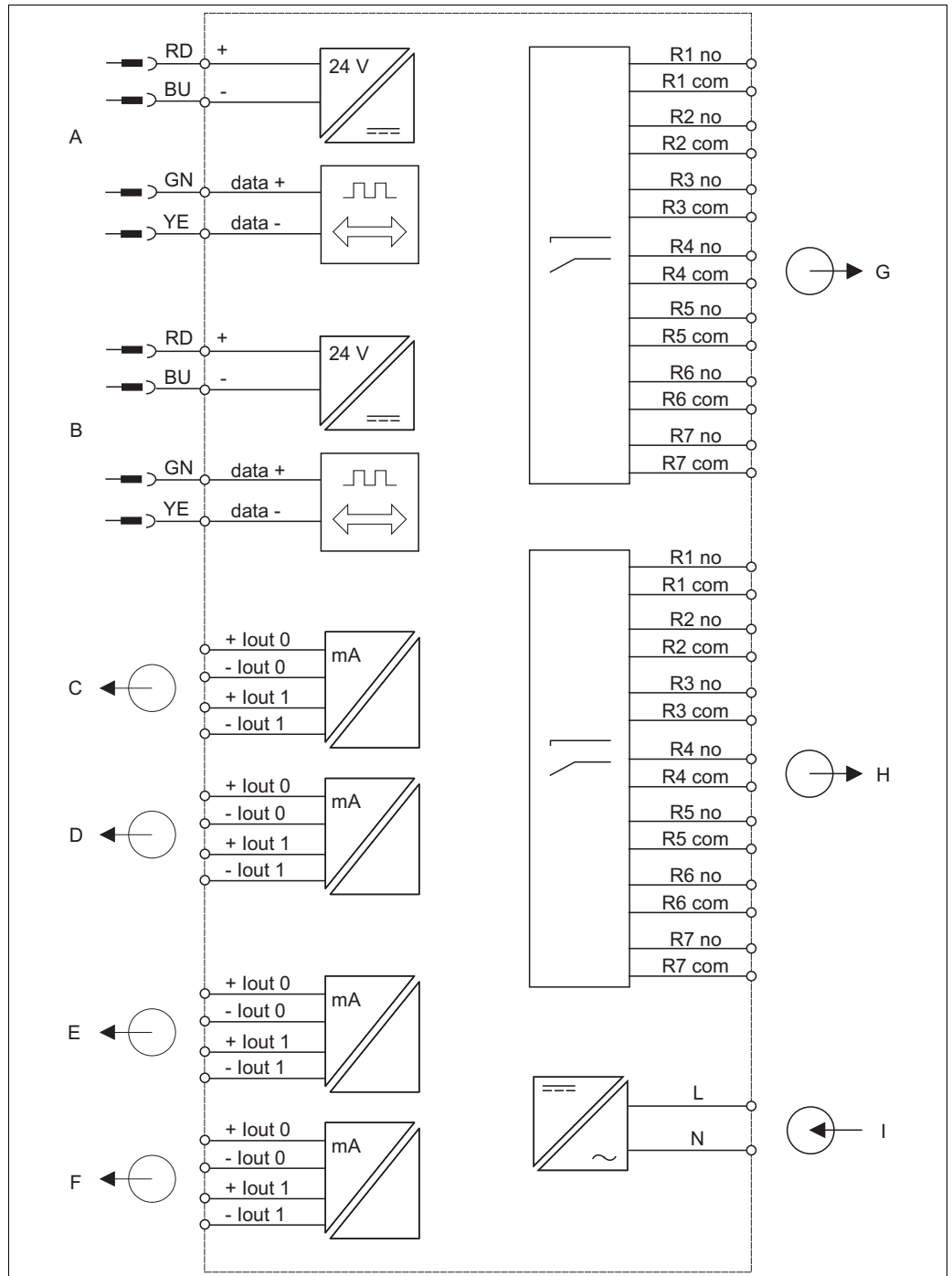

Fig. 11: Electrical connection of the transmitter (stainless steel and aluminum version)

- |   |                          |   |                          |
|---|--------------------------|---|--------------------------|
| A | Sensor 1                 | F | Signal output 2 sensor 2 |
| B | Sensor 2                 | G | Relays 1 to 7 sensor 1   |
| C | Signal output 1 sensor 1 | H | Relays 1 to 7 sensor 2   |
| D | Signal output 2 sensor 1 | I | Power supply             |
| E | Signal output 1 sensor 2 |   |                          |



Fig. 12: Interior view

- 1 TA7520 converter RS-232 / RS-485
- 2 TA 7022 analog outputs
- 3 TA7067 relay outputs
- 4 Power unit for sensor
- 5 Power unit for panel PC and modules

## 4.2.2 Connecting the signal outputs

The transmitter is equipped with a maximum of two analog modules per sensor (optional). Each module has two signal outputs.

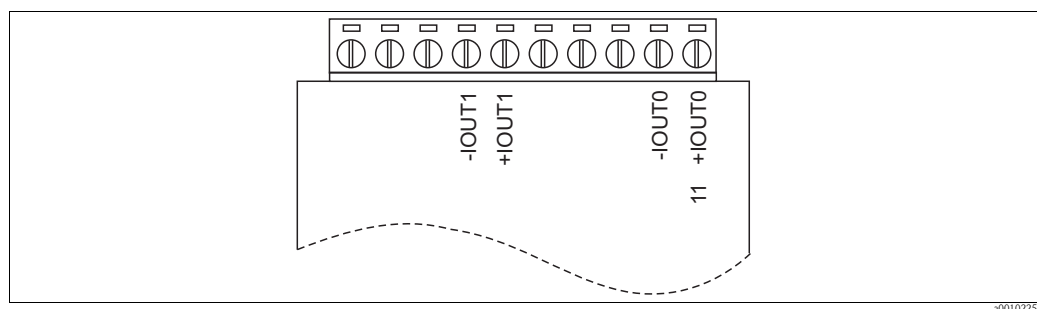

Fig. 13: Connecting the signal outputs

Connect the analog modules as follows:

1. Guide the signal cable through the cable bushing.
2. Guide the signal cable through the cable conduits to the appropriate analog modules.
3. Connect the signal cables to the analog modules (s. Abb. 13).



Note!

The terminal block can be removed to facilitate access to the locking screws.

### 4.2.3 Connecting the relay outputs

The transmitter can be optionally fitted with one relay module per sensor. Each module has seven relay outputs. The relay outputs function as NC contacts.

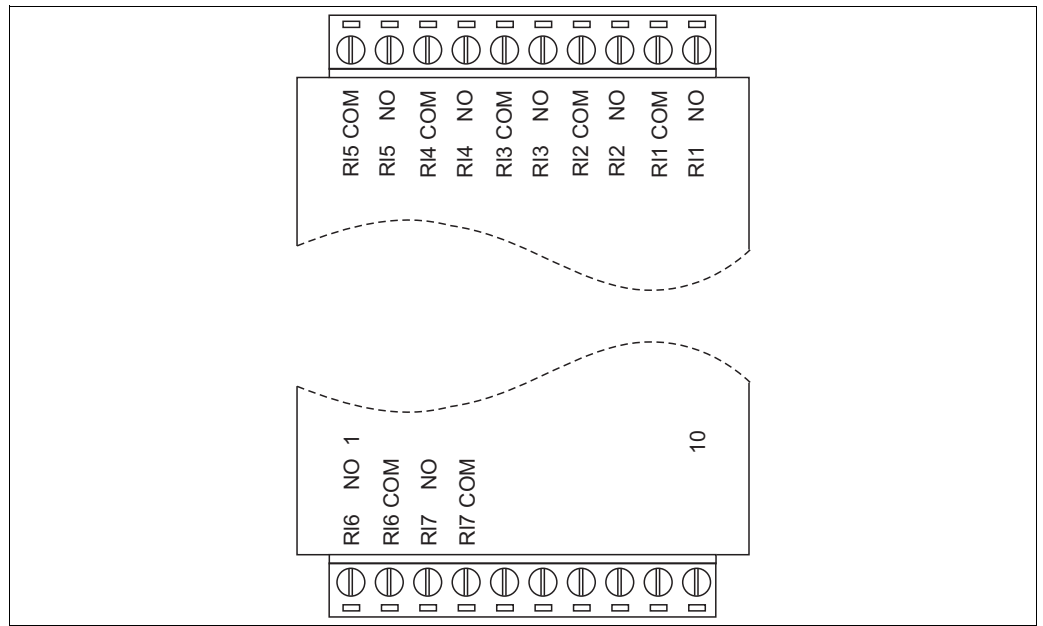

Fig. 14: Connecting the relay module

Connect the relay module as follows:

1. Guide the connecting cable through the cable bushing.
2. Guide the connecting cable through the cable conduits to the appropriate relay module.
3. Attach the connecting cable to the relay module (s. Abb. 14).



Note!

The terminal block can be removed to facilitate access to the locking screws.

#### 4.2.4 Connecting the panel PC

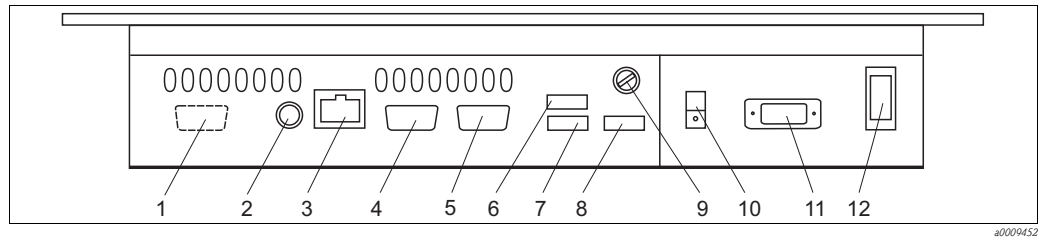

Fig. 15: Panel PC connections

1	PROFIBUS connection	7	USB
2	PS/2 connection	8	USB
3	LAN connection	9	Fuse
4	COM 2	10	Ground connection
5	COM 1	11	Supply voltage
6	USB	12	On/Off switch

The panel PC is fully wired, with the exception of the optional PROFIBUS connection.

Connect the optional PROFIBUS connection as follows:

1. Guide the PROFIBUS cable through the Pg threaded connection.
2. Solder the D-sub connector onto the PROFIBUS cable.
3. Plug the D-sub connector into the socket of the PROFIBUS card (pos. 1).

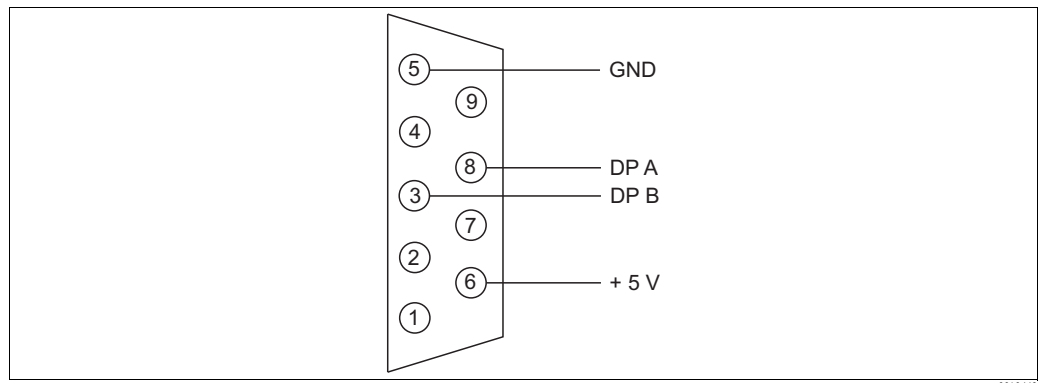

Fig. 16: Bus cable connection

#### 4.3 Connecting sensor and transmitter (aluminum version)

Connect the sensor and the transmitter as follows:

1. Ground the upright post or the wall bracket.
2. Install the connecting cable between the sensor and transmitter.
3. If the transmitter is equipped with signal outputs, connect the signal outputs.
4. If the transmitter is equipped with relay outputs, connect the relay outputs.
5. If the transmitter is equipped with a PROFIBUS card, connect the fieldbus cable.
6. Connect the power cable.

### 4.3.1 Electrical connection of transmitter

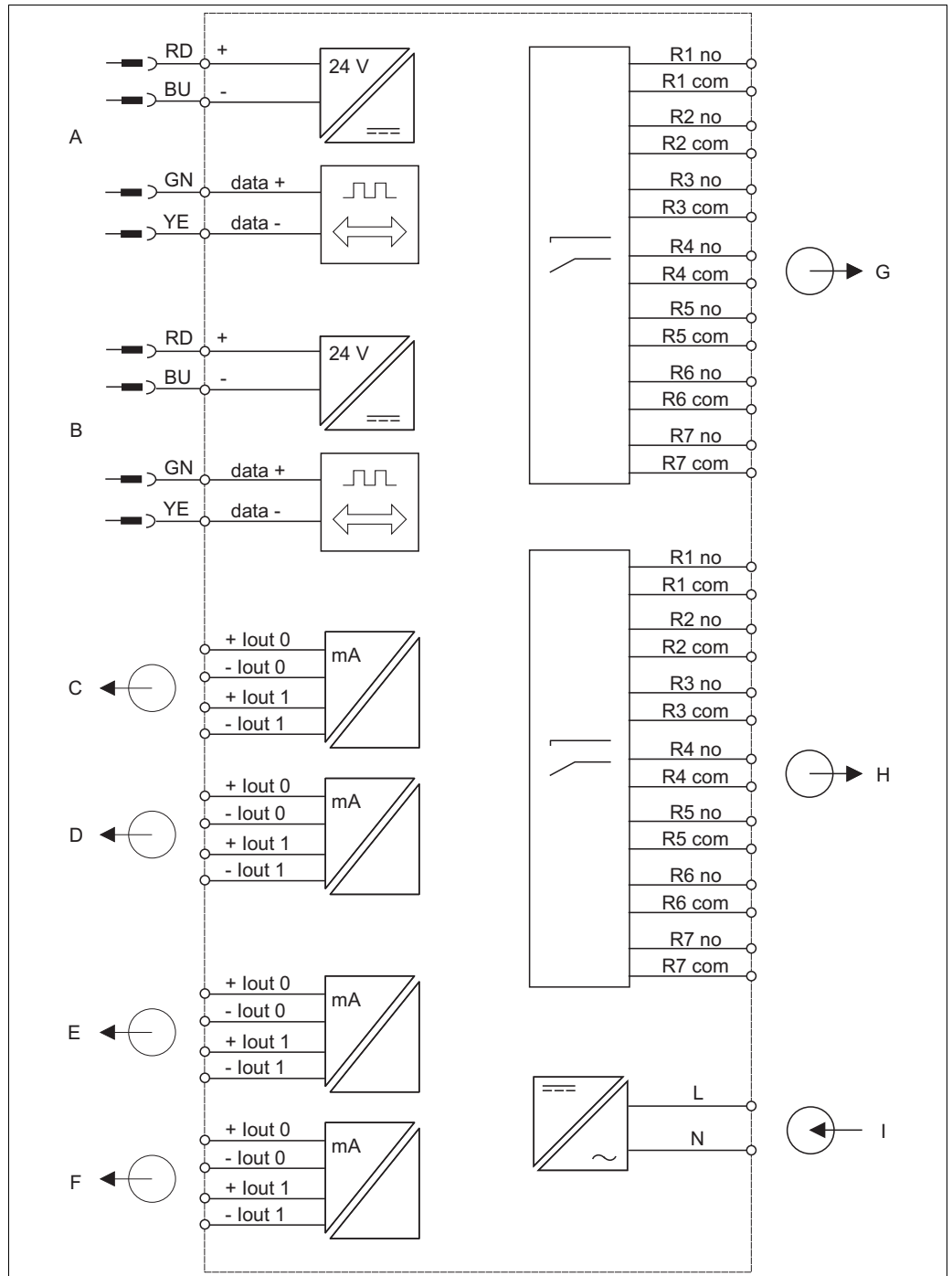

a0007181

Fig. 17: Electrical connection of the transmitter (stainless steel and aluminum version)

- |   |                          |   |                          |
|---|--------------------------|---|--------------------------|
| A | Sensor 1                 | F | Signal output 2 sensor 2 |
| B | Sensor 2                 | G | Relays 1 to 7 sensor 1   |
| C | Signal output 1 sensor 1 | H | Relays 1 to 7 sensor 2   |
| D | Signal output 2 sensor 1 | I | Power supply             |
| E | Signal output 1 sensor 2 |   |                          |

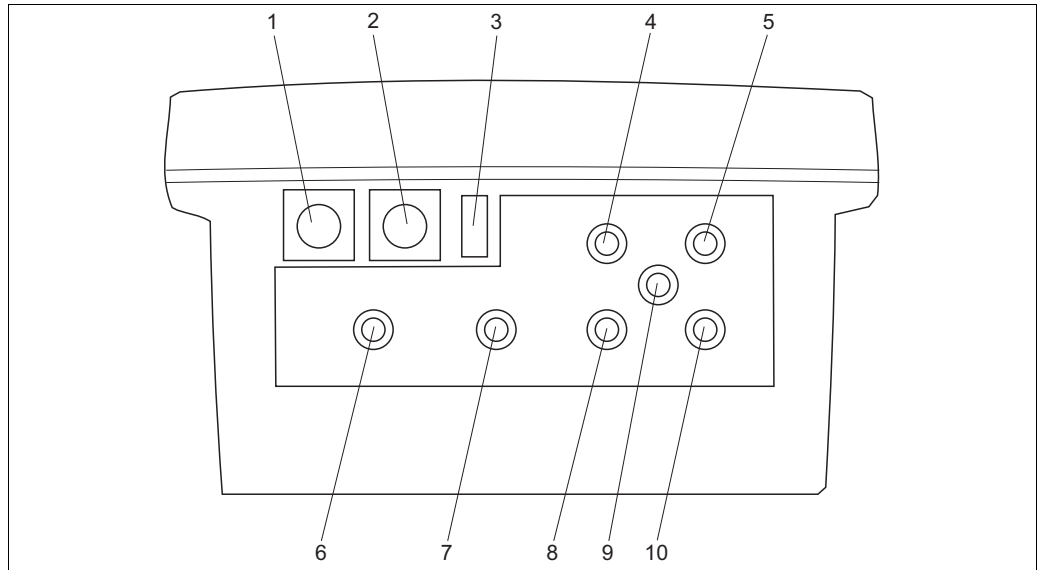

a0011505

Fig. 18: Connections of the transmitter (aluminum version)

- |   |                                         |    |                                                  |
|---|-----------------------------------------|----|--------------------------------------------------|
| 1 | Sensor 1                                | 6  | Relay outputs sensor 1 (Pg threaded connection)  |
| 2 | Sensor 2                                | 7  | Signal outputs sensor 1 (Pg threaded connection) |
| 3 | Power switch                            | 8  | Relay outputs sensor 2 (Pg threaded connection)  |
| 4 | Power cable (Pg threaded connection)    | 9  | PROFIBUS cable (Pg threaded connection)          |
| 5 | PROFIBUS cable (Pg threaded connection) | 10 | Signal outputs sensor 2 (Pg threaded connection) |

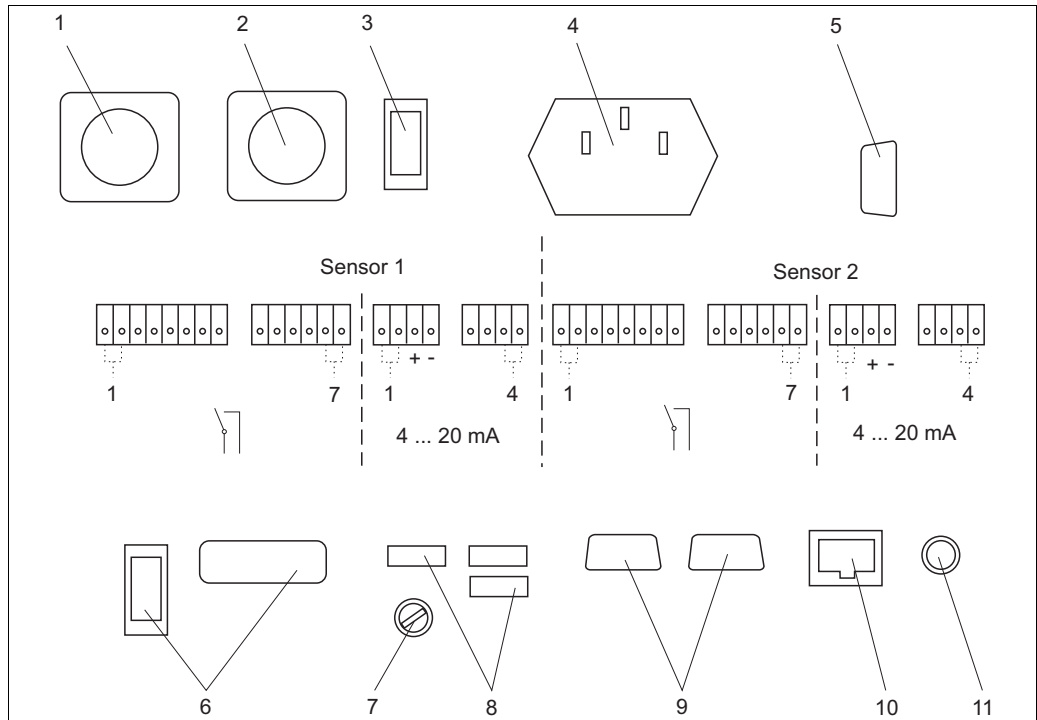

a0011442

Fig. 19: Connections inside (aluminum version)

- |   |                                |    |               |
|---|--------------------------------|----|---------------|
| 1 | Sensor 1                       | 7  | Fuse          |
| 2 | Sensor 2                       | 8  | 3 x USB       |
| 3 | Power switch                   | 9  | 2 x COM RS232 |
| 4 | Power connection               | 10 | LAN           |
| 5 | PROFIBUS connection (optional) | 11 | PS/2          |
| 6 | without function               |    |               |

### 4.3.2 Connecting the relay and signal outputs

The transmitter is optionally equipped with:

- Seven relay outputs per sensor (the outputs function as NC contacts).
- Maximum of four signal outputs per sensor.

Connect the outputs as follows:

1. Guide the cables through the corresponding Pg threaded connections.
2. Connect the cables.

### 4.3.3 Connecting the PROFIBUS

Connect the optional PROFIBUS connection as follows:

1. Guide the PROFIBUS cable through the Pg threaded connection.
2. Solder the D-sub connector onto the PROFIBUS cable.
3. Plug the D-sub connector into the socket of the PROFIBUS card.

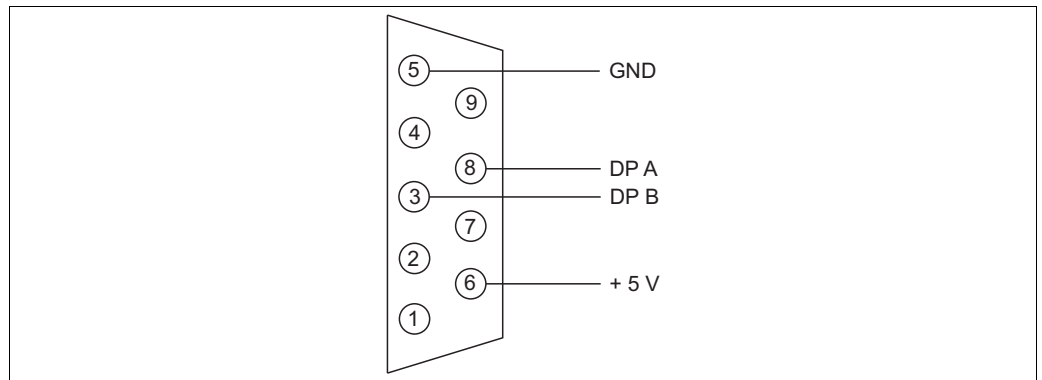

Fig. 20: Bus cable connection

### 4.3.4 Connecting of the power

Connect the power cable as follows:

1. Guide the power cable through the corresponding Pg threaded connection.
2. Connect the power cable to the delivered female plug.
3. Put the female plug into the socket.

## 4.4 Post-connection check

When electrical connection is complete, perform the following checks:

Device status and specifications	Notes
Is there any damage to the exterior of the transmitters and cables?	Visual inspection
Does the mains voltage correspond to the nameplate data?	

Electrical connection	Notes
Are the assembled cables strain-relieved?	
Is the cable conduit free from loops and crossovers?	Visual inspection
Are all lines connected correctly in accordance with the wiring diagram?	
Are all screw terminals securely tightened?	
Are all cable entries assembled, secured tightly and sealed?	
Is the upright post grounded?	Grounding is performed onsite.



## 5 Operation

### 5.1 Human interface

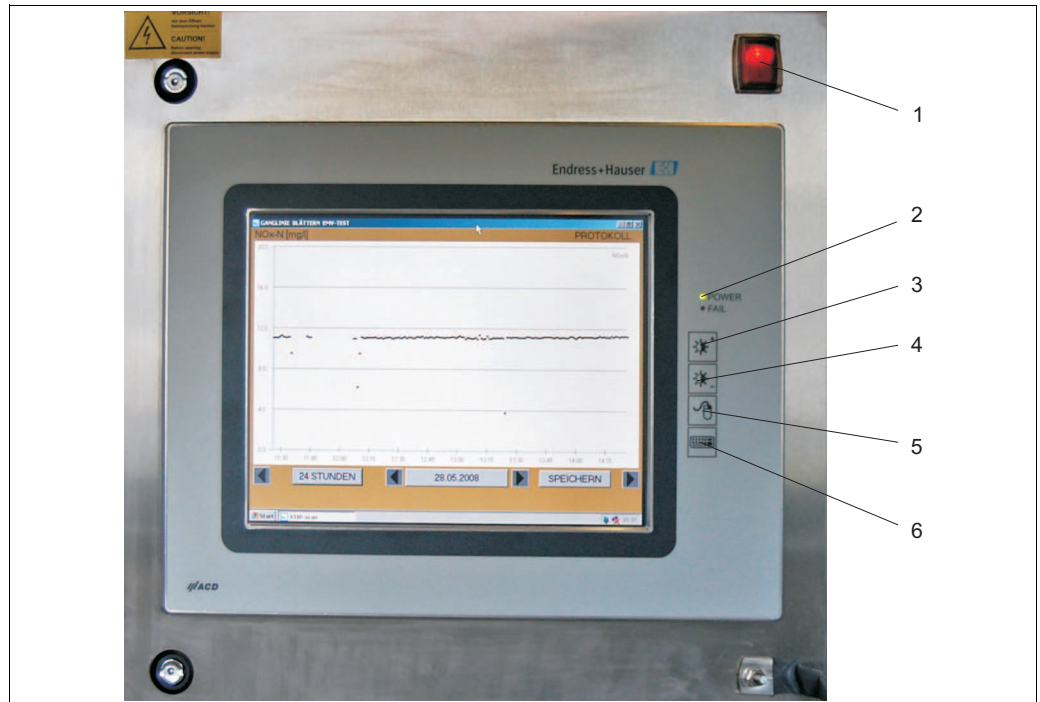

Fig. 21: Operating elements of the panel PC

- 1 On/Off switch
- 2 Power and error LEDs
- 3 Brightness plus
- 4 Brightness minus
- 5 Right mouse button
- 6 Display and hide keyboard

The measuring system is operated using the PC touchscreen.

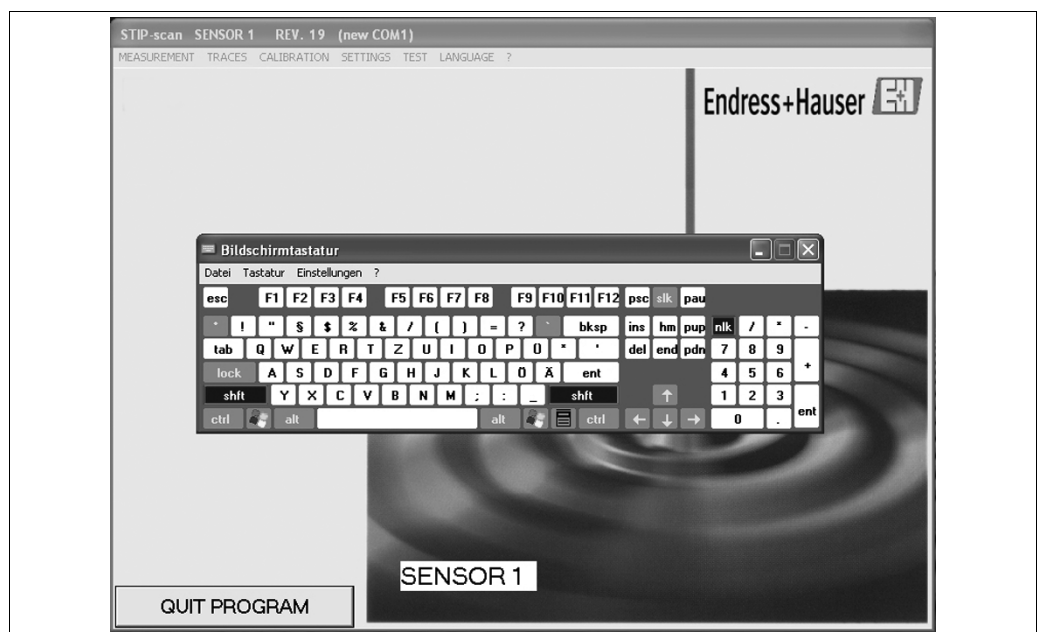

Fig. 22: Touchscreen with keyboard

You can display the keyboard using the keyboard button (to the right of the touchscreen).

## 5.2 Onsite operation

### 5.2.1 MEASUREMENT menu

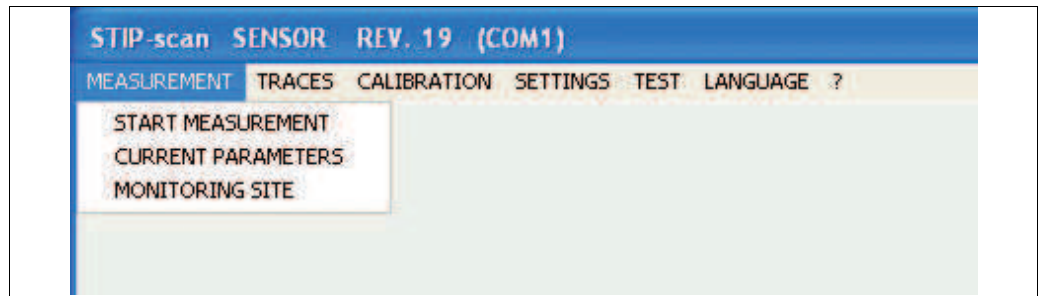

Fig. 23: MEASUREMENT menu

#### START MEASUREMENT

In the **MEASUREMENT** menu, select the **START MEASUREMENT** menu option. The measuring system starts measurement, opens two additional windows (**TRACE** and **MEASURED VALUES**) and generates the following message: **SENSOR IN NORMAL OPERATION**

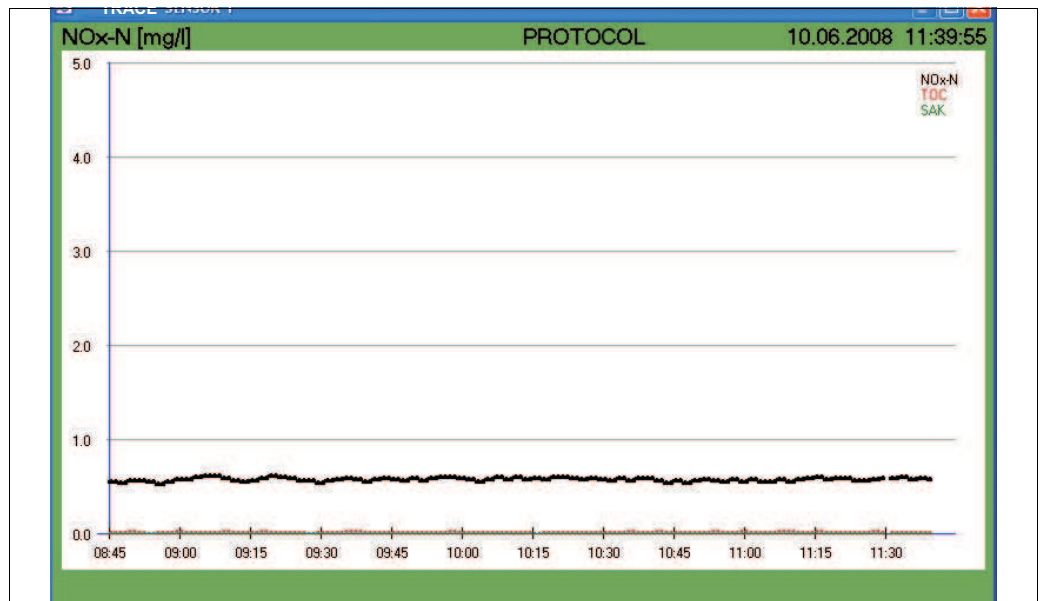

Fig. 24: TRACE window

This windows shows the traces for the selected parameters. Details of the traces are described in the "Traces" section.

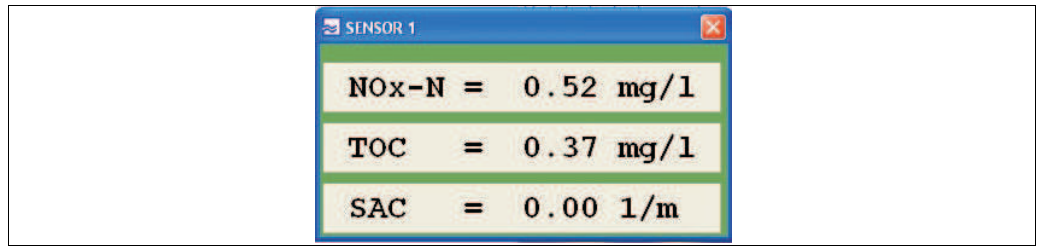

Fig. 25: MEASURED VALUES window

Stop measurement in the **MEASUREMENT** menu by selecting the **STOP MEASUREMENT** menu option.



Note!

During measurement, the **TEST** menu and the menu options **KHP VALIDATION**, **NOx VALIDATION** and **TAKE SAMPLE SPECTRA** are deactivated.

### CURRENT PARAMETERS

In the **MEASUREMENT** menu, select the **PARAMETER** menu option.

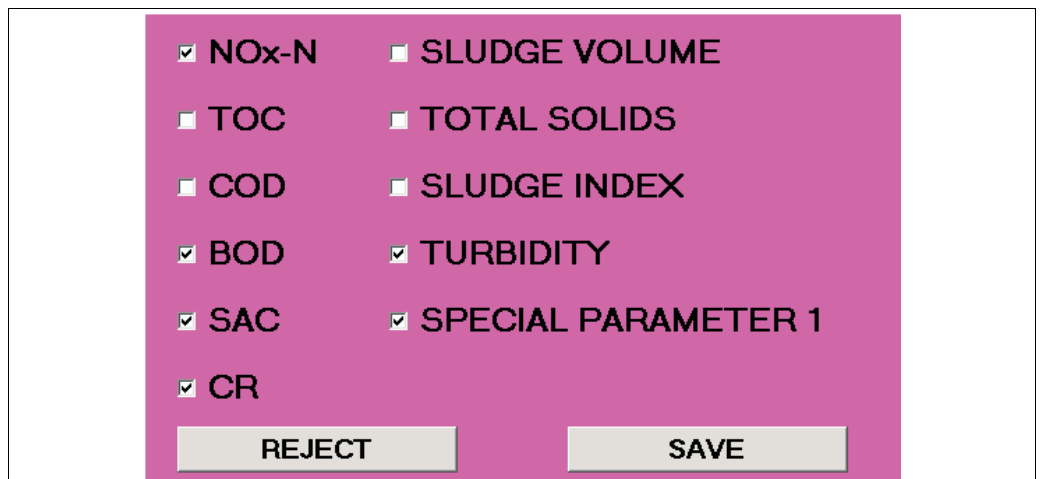

Fig. 26: PARAMETERS window

Please note that:

- You can select only one parameter at a time for the parameters **TOC**, **COD** and **BOD**.
- You can activate **SPECIAL PARAMETER** only for sensor version SP (can be specified on customer demand).
- **CR** stands for contamination rate.

Select the relevant parameters, and record your selection using **SAVE**.

Using the **REJECT** button, you can delete your settings and restore the previous settings.

## MONITORING SITE

In the **MEASUREMENT** menu, select the **MONITORING SITE** menu option.



Fig. 27: *MONITORING SITE* window



Note!

The measuring point must be specified for the purpose of plausibility testing.

Select the relevant measuring point and record your selection using **SAVE**.

Using the **REJECT** button, you can delete your settings and restore the previous settings.

### 5.2.2 TRACES menu

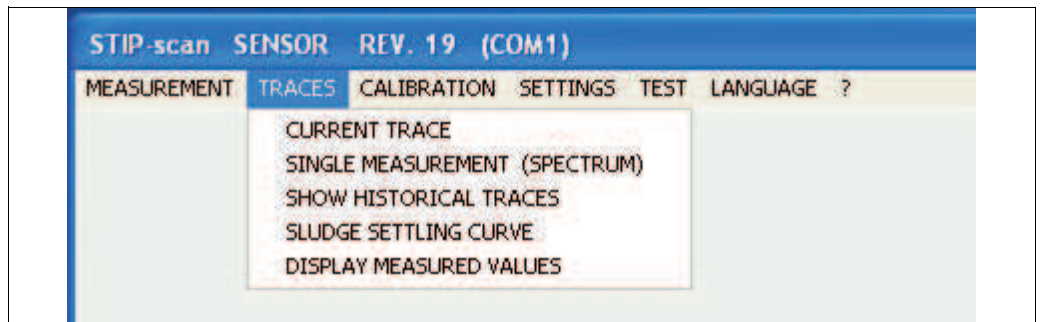

Fig. 28: TRACES menu

#### CURRENT TRACE

This menu option displays the current trace. The trace of the scaled parameter is displayed in bold. In the **TRACES** menu, select the **CURRENT TRACE** menu option.

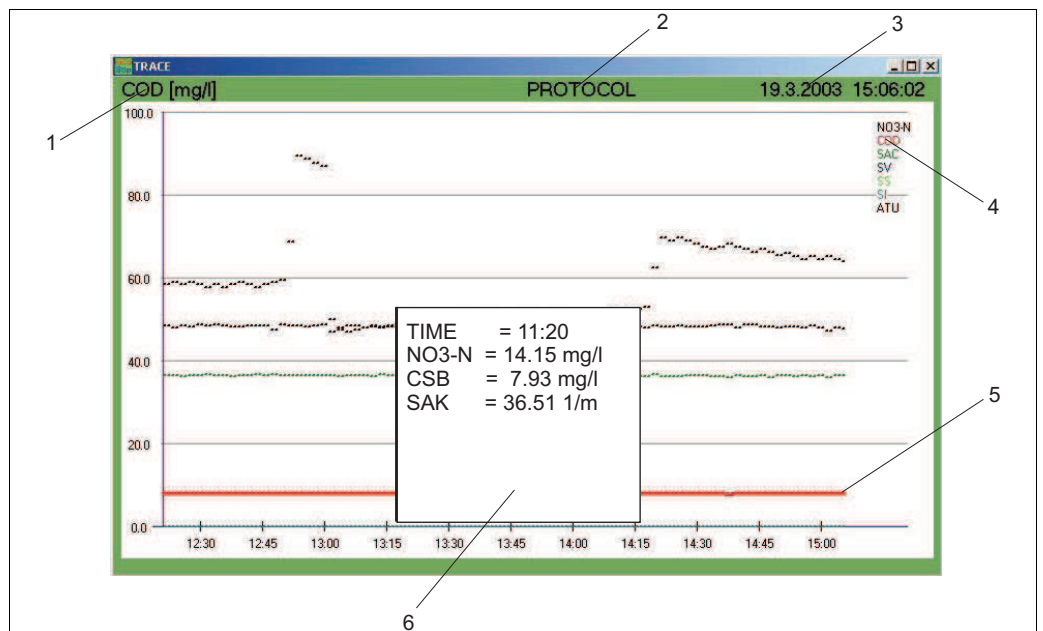

Fig. 29: Current trace

- 1 The Y axis is scaled for this parameter.
- 2 You can access the daily log here.
- 3 Date and time display
- 4 Selected parameters
- 5 Trace
- 6 Window with measured values

### Scaling

Enter the scaling as follows:

1. Click on the parameter (pos. 1, Fig. 29).

The SCALE window opens.

Parameter	Maximum Value	Unit
<input checked="" type="radio"/> NOx-N	20.0	mg/l
<input type="radio"/> COD	200.0	mg/l
<input type="radio"/> TOC	200.0	mg/l
<input type="radio"/> SAC	100.0	1/m
<input type="radio"/> BOD	200.0	mg/l
<input type="radio"/> SV	500.0	ml/l
<input type="radio"/> TS	200.0	g/l
<input type="radio"/> SI	200.0	ml/g
<input type="radio"/> TUR	100.0	1/m
<input type="radio"/> CR	100.0	1/m
<input type="radio"/> SP1	200.0	mg/l

REJECT SAVE

Fig. 30: SCALE window

- 1 Parameter
- 2 Maximum value of Y axis

2. Select the desired parameter.
3. Enter the maximum value of the Y axis.
4. Confirm your entries using **SAVE**.

### Protocol

Click on PROTOCOL (pos. 2, Fig. 29), to access the daily log.

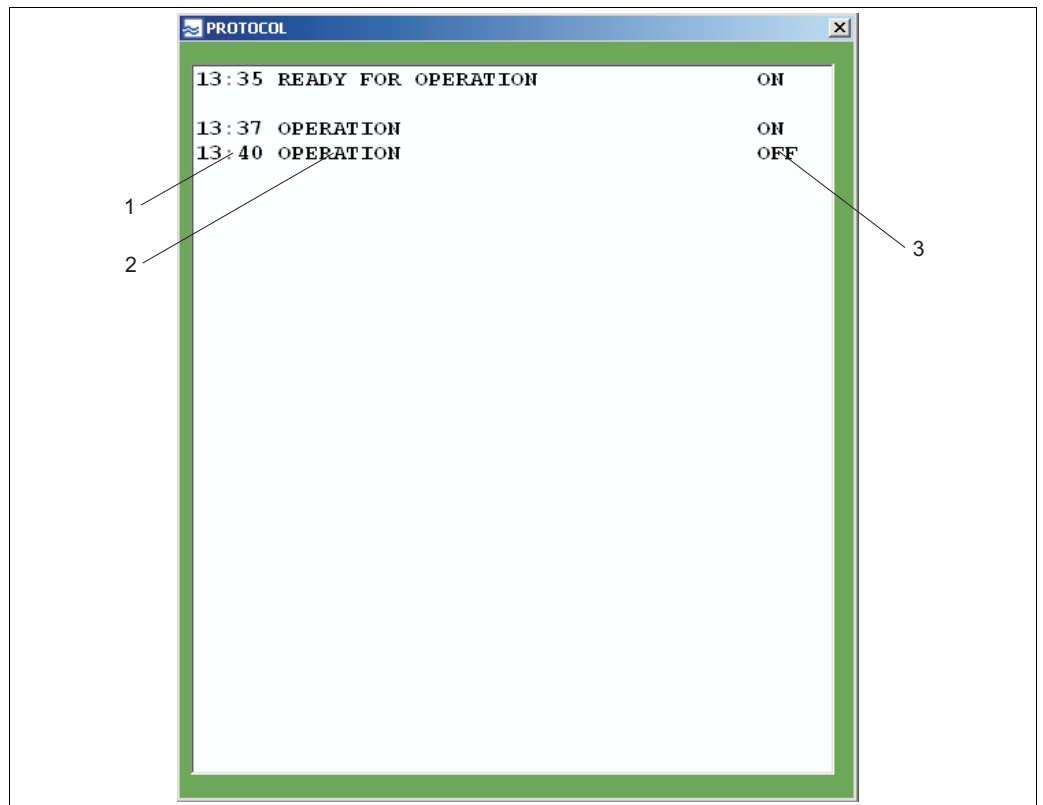

Fig. 31: Daily log

- 1 Time
- 2 Message
- 3 Activation

The daily log lists the status messages for the sensor and the warnings and error messages.

### Date and time

Date and time are displayed in the menu bar (pos. 3, Fig. 29).

### Parameters and trace

The selected measurement parameters are displayed in pos. 4, Fig. 29. The color is used to identify the associated trace (pos. 5, Fig. 29).

### Measured value window

Click within the diagram along the X axis. The measured values are then displayed in a window (pos. 6, Fig. 29) according to time.

## SINGLE MEASUREMENT

This menu option shows you different spectra as a function of wavelength. This menu option is available only in the CAS74-SPxx version.

In the **TRACES** menu, select the **SINGLE MEASUREMENT (SPECTRUM)** menu option.

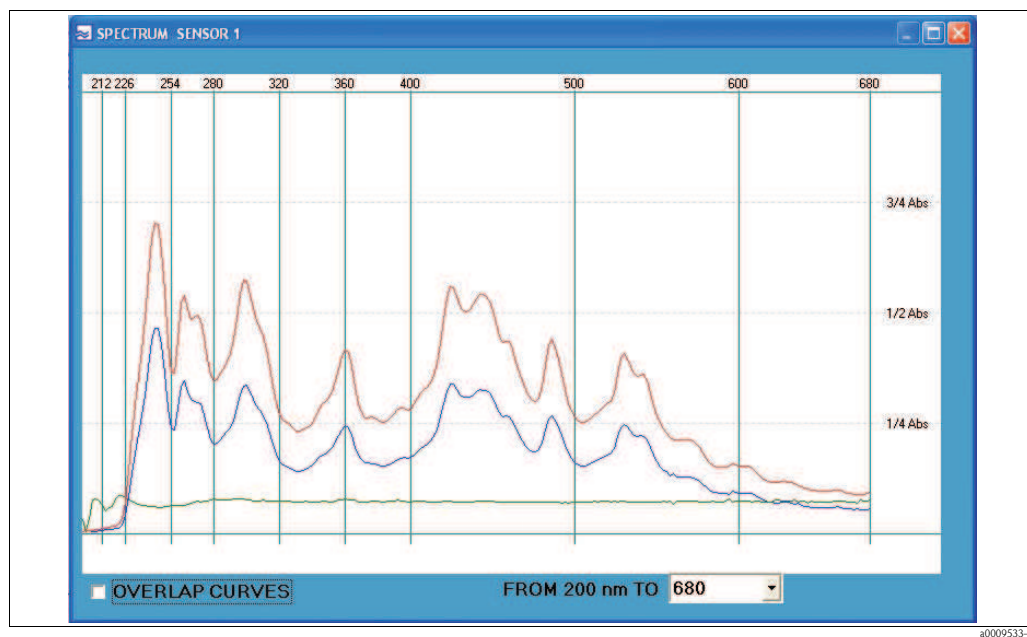

Fig. 32: Single measurement (spectrum)

Identifying the spectra:

Red line	Reference intensity with distilled water
Blue line	Intensity of current measurement
Green line	Measured absorption spectrum

The following settings are possible:

- Display several measurements in one diagram.  
Activate OVERLAP CURVES (lower left-hand corner).
- Adjust wavelength range.  
Select the desired maximum wavelength from the picklist (maximum value of X axis).



## SHOW HISTORICAL TRACES

You can use this menu option to page through the traces.

In the **TRACES** menu, select the **SHOW HISTORICAL TRACES** menu option.

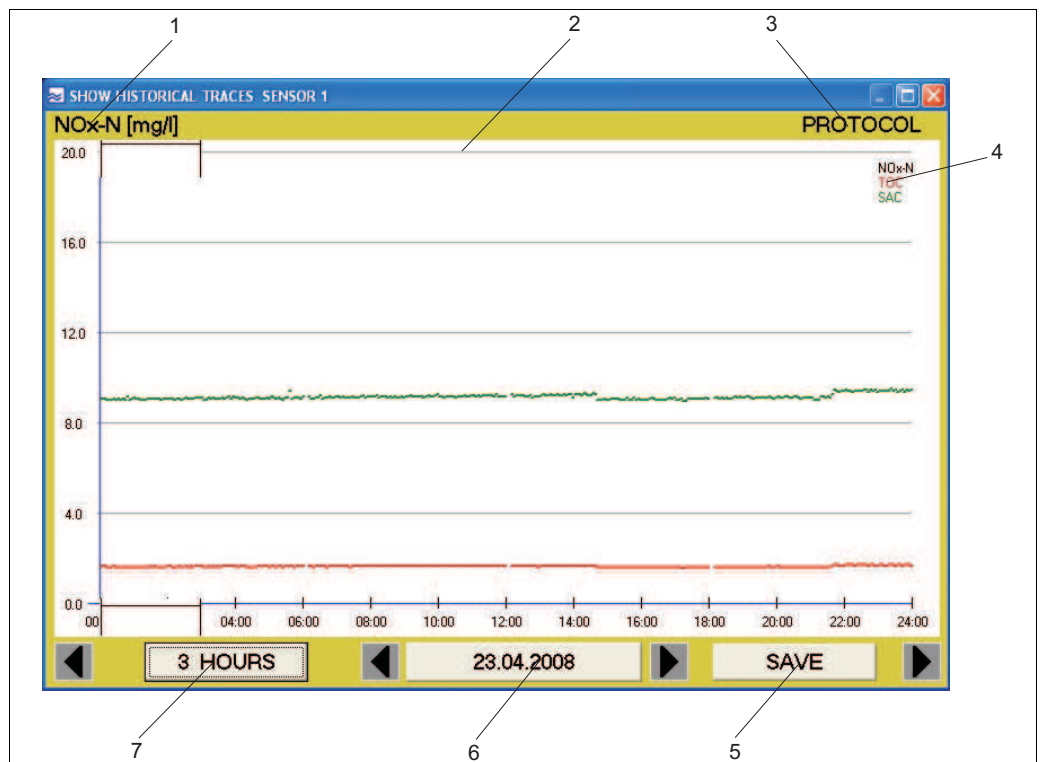

Fig. 33: Show historical traces

- 1 Parameter whose Y axis scale is active
- 2 Time window
- 3 Protocol displays the daily log
- 4 Selected parameters
- 5 Saves the measured values in a csv file
- 6 Date display
- 7 Zoom function (scaling of the time axis)

### Time window

Move the time window (pos. 2, Fig. 33) to where you want to look at the trace in greater detail. Then click on the 3 HOURS button. The trace is displayed for the selected time period. One click on the 24 HOURS button brings you back.

**Daily log**

Click on PROTOCOL (pos. 3, Fig. 33) to view the daily log.

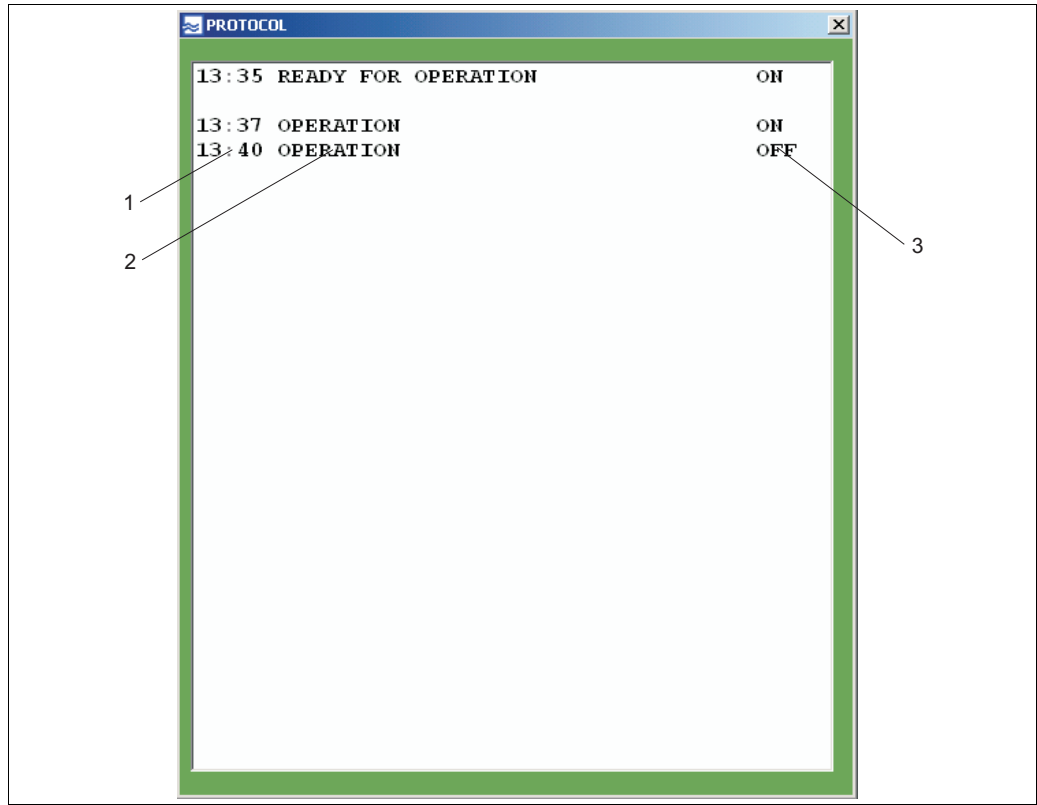

Fig. 34: Daily log

- 1 Time
- 2 Message
- 3 Activation

**Scaling of Y axis**

Scaling of the Y axis is determined by a parameter (pos. 1, Fig. 33). In this screenshot it is NO<sub>x</sub>-N. To change the scaling, click on the parameter displayed. The following window appears:

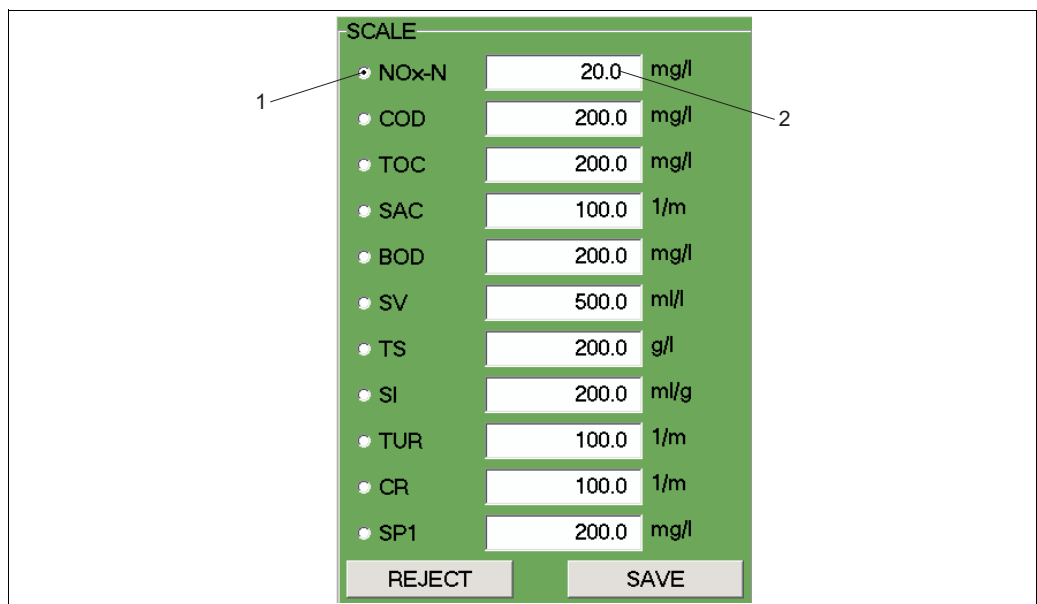

Fig. 35: Scaling of Y axis

- 1 Parameter
- 2 Maximum value of Y axis

**Selected parameters**

The parameters selected for measurement are displayed here (pos. 4, Fig. 33). Each parameter is assigned its own color for trace identification.

**Save**

Click on the SAVE button (pos. 5, Fig. 33) to save the measured values for a selected day in a csv file.

**Date display**

The date display (pos. 6, Fig. 33) shows you when the trace was created. You can use the relevant arrow keys to page back and forth.

**Zoom function**

You can use this button (pos. 7, Fig. 33) to choose between the 24-hour display and the 3-hour display.

### SLUDGE SETTLING CURVE

This menu option shows you the sludge settling curve.

In the **TRACES** menu, select the **SLUDGE SETTLING CURVE** menu option.

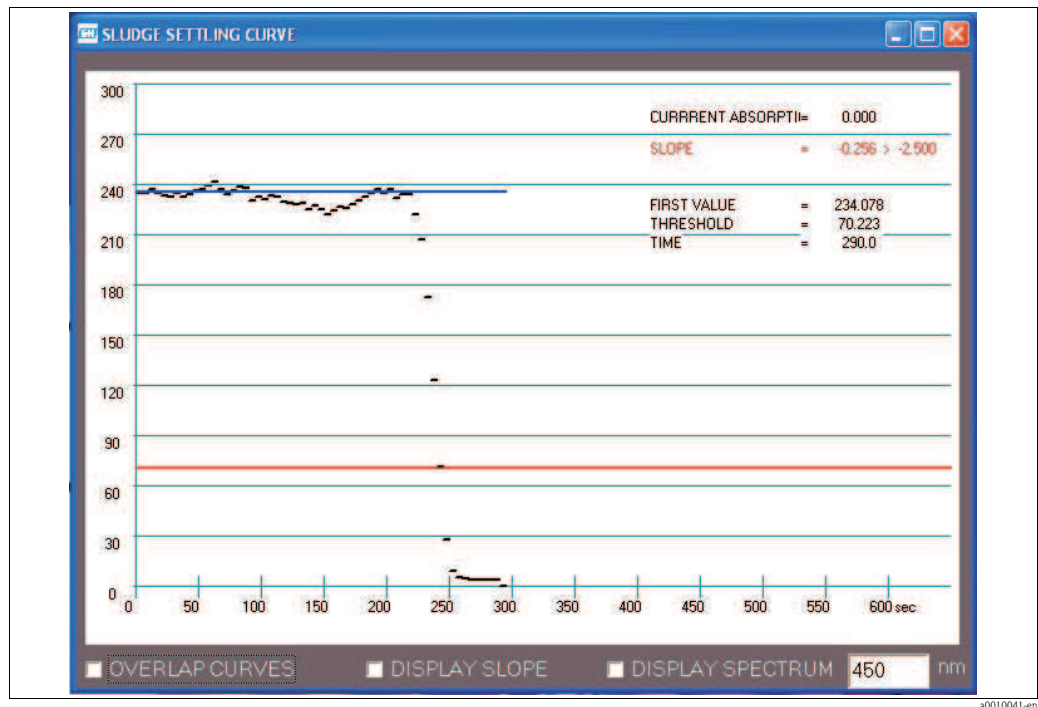

Fig. 36: Sludge settling curve

The following settings are possible:

- Display several measurements in one diagram.  
Activate OVERLAP CURVES (lower left-hand corner).
- Display slope of settling curve.  
Activate DISPLAY SLOPE.
- Display absorption spectrum.  
Activate DISPLAY SPECTRUM.



Note!

The DISPLAY SLOPE and DISPLAY SPECTRUM functions are available only in the CAS74-SPxx version.

### MEASURED VALUES

This menu option shows you the measured values in tabular form.

In the **TRACES** menu, select the **MEASURED VALUES** menu option.

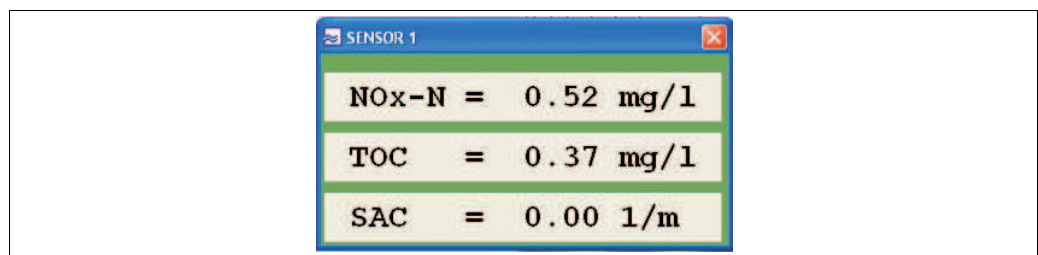

Fig. 37: Measured values in tabular form

## TRACE POLLUTION

This menu option shows you the pollution level of the cell on air.  
In the **TRACES** menu, select the **TRACE POLLUTION** menu option.

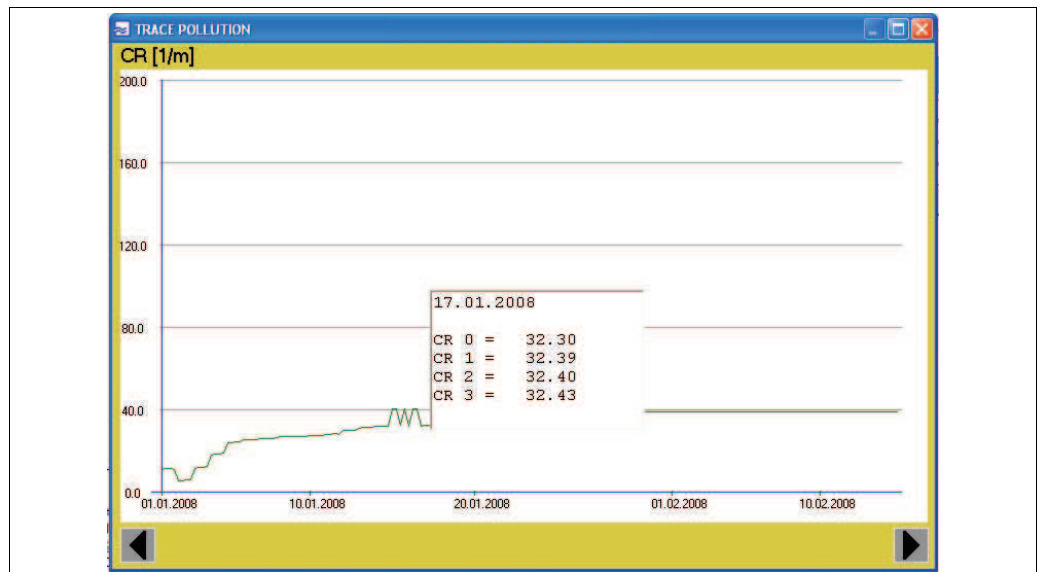

Fig. 38: Trace pollution

If the CR parameter is activated, the contamination rate is measured automatically every 6 hours:

CR 0	00:00 hours
CR 1	06:00 hours
CR 2	12:00 hours
CR 3	18:00 hours

### 5.2.3 CALIBRATION menu

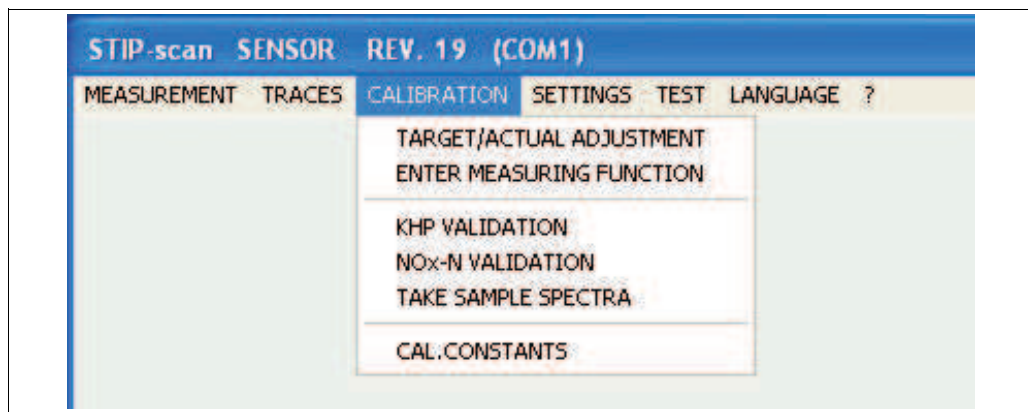

Fig. 39: CALIBRATION menu

Calibration is used to adapt the measuring system to the conditions of the measuring point.

- Do a separate calibration for each of the following parameters: NO<sub>x</sub>-N, COD<sub>eq</sub> or TOC<sub>eq</sub> or BOD<sub>eq</sub>, SV and TS.
- The parameters SAC, SI and ATU do not need to be calibrated.

#### Preparing for calibration

For calibration you need laboratory values from samples and the corresponding measured values from the measuring system.

These values are obtained as follows:

1. Start measurement and allow the measuring system to measure for an entire day.
2. After one day, take a look at the traces for the day, and determine for each parameter the time at which the maximum and minimum measured values occur. The difference between maximum and minimum should be at least 30% of the maximum measured value (not for the parameters SV and TS).
3. On the following day, take three samples for each parameter at the times calculated (minimum and maximum). Note the associated measured values.
4. Before analyzing the samples in the laboratory, the samples must be pretreated as follows:

Measuring point	Pretreatment
Inlet	Settling of suspended matter
Sludge activation	Filtering out of suspended matter
Outlet	No pretreatment required

5. Perform the reference measurements for the samples in the laboratory.

Using the measured values from the measuring system and the measured values from the laboratory, you can now perform the TARGET/ACTUAL ADJUSTMENT.

## TARGET/ACTUAL ADJUSTMENT

This menu option is used to calibrate the measuring system.

In the **CALIBRATION** menu, select the **TARGET/ACTUAL ADJUSTMENT** menu option.

PARAMETER		NOx-N			
NITRATE					
	STIP-scan	LAB. 1	LAB. 2	LAB. 3	
HIGH	10.0	10.0	10.0	10.0	
LOW	1.0	1.0	1.0	1.0	

Buttons: REJECT, RESET CALIBRATION, SAVE, INPUT COMPLETE

Fig. 40: Calibration menu

Carry out the calibration as follows:

1. Select the calibration parameter (e.g. NO<sub>x</sub>-N).
2. In the "STIP-scan" column, enter the highest and the lowest value.
3. In each of the columns "Lab. 1 - 3", enter the value calculated in the laboratory.
4. Activate entries using the **SAVE** button.

The system uses the values entered to calculate the calibration constants (slope and zero point shift of the calibration lines).

The measuring system is thus calibrated for the selected parameter.

Using the **RESET CALIBRATION** button, you can reset the calibration constants to the factory setting.

## ENTER MEASURING FUNCTION

With this menu option you enter a quadratic measuring function. This quadratic measuring function overwrites the **TARGET/ACTUAL ADJUSTMENT**. The **RESET FUNCTION** button is used to reactivate the **TARGET/ACTUAL ADJUSTMENT**.

If you require the quadratic measuring function, please contact E+H Service. E+H Service calculates the data for your measuring function.

In the **CALIBRATION** menu, select the **ENTER MEASURING FUNCTION** menu option.

PARAMETER: NOx-N

NITRATE

NO<sub>x</sub>-N = 0.00000 x<sup>2</sup> + 1.00000 x + 0.00000

Buttons: REJECT, RESET FUNCTION, SAVE, INPUT COMPLETE

Fig. 41: Enter measuring function

Enter the measuring function as follows:

1. Select the parameter (e.g. NO<sub>x</sub>-N).
2. Enter the three values for the measuring function.
3. Activate entries using the **SAVE** button.

### KHP VALIDATION

This menu option is used to check the measuring system for the carbon parameters using a KHP standard solution. To do this, you need a KHP solution with a concentration of 50 mg/l KHP.

For KHP validation, proceed as follows:

1. In the **CALIBRATION** menu, select the **KHP VALIDATION** menu option.  
The measuring system empties the measuring cell. After the measuring cell has been emptied, you are requested to immerse the sensor in the KHP solution.
2. Remove the sensor from the wastewater.
3. Thoroughly clean the exterior of the sensor.
4. Place the sensor in the KHP solution.
5. Use the **OK** button to confirm that the sensor is in the KHP solution.

The quartz cell is rinsed times in KHP solution before starting measurement. Once measurement has been completed, the value calculated by the measuring system is displayed.



Note!

If the value calculated deviates from the set point of the KHP solution by more than 10%, please contact Endress+Hauser Service.

### NO<sub>x</sub> VALIDATION

This menu option is used to check the measuring system for the nitrogen parameters using an NO<sub>x</sub> standard solution. To do this, you need an NO<sub>x</sub> solution with a concentration of 10 mg/l NO<sub>3</sub>-N.

For NO<sub>x</sub> validation, proceed as follows:

1. In the **CALIBRATION** menu, select the **NO<sub>x</sub> VALIDATION** menu option.  
The measuring system empties the measuring cell. After the measuring cell has been emptied, you are requested to immerse the sensor in the NO<sub>x</sub> solution.
2. Remove the sensor from the wastewater.
3. Thoroughly clean the exterior of the sensor.
4. Place the sensor in the NO<sub>x</sub> solution.
5. Use the **OK** button to confirm that the sensor is in the NO<sub>x</sub> solution.

The quartz cell is rinsed times in NO<sub>x</sub> solution before starting measurement. Once measurement has been completed, the value calculated by the measuring system is displayed.



Note!

If the value calculated deviates from the set point of the NO<sub>x</sub> solution by more than 10%, please contact Endress+Hauser Service.



## TAKE SAMPLE SPECTRA

This menu option is used to record liquids in the range of any wavelengths. This menu option is available only in the CAS74-SPxx version.

In the **CALIBRATION** menu, select the **TAKE SAMPLE SPECTRA** menu option.

Fig. 42: TAKE SAMPLE SPECTRA window

Enter the following data:

Entry field	Description
SAMPLE NO.	Enter the number of your sample.
CONCENTRATION (mg/l)	Enter the concentration in mg/l.
NUMBER OF FLUSHES	Enter how many flushes are necessary prior to measurement.
SPECTRUM BETWEEN (nm)	Enter the wavelength at which absorption measurement is to commence.
AND (nm)	Enter the wavelength up to which absorption measurement is to take place.
FILE NAME	Enter the file name under which the measured values are to be saved.

Start measurement using the **START MEASUREMENT** button.

The measurement results are displayed in the right-hand window and in the trace window which opens.

The measured values for absorption and intensity are saved to the following files:

- Measured values for absorption: FILENAME.p\_a
- Measured values for intensity: FILENAME.p\_i

The files can be viewed using Microsoft Excel.

## CAL.CONSTANTS

This menu option displays the calibration constants.

In the **CALIBRATION** menu, select the **CAL.CONSTANTS** menu option.

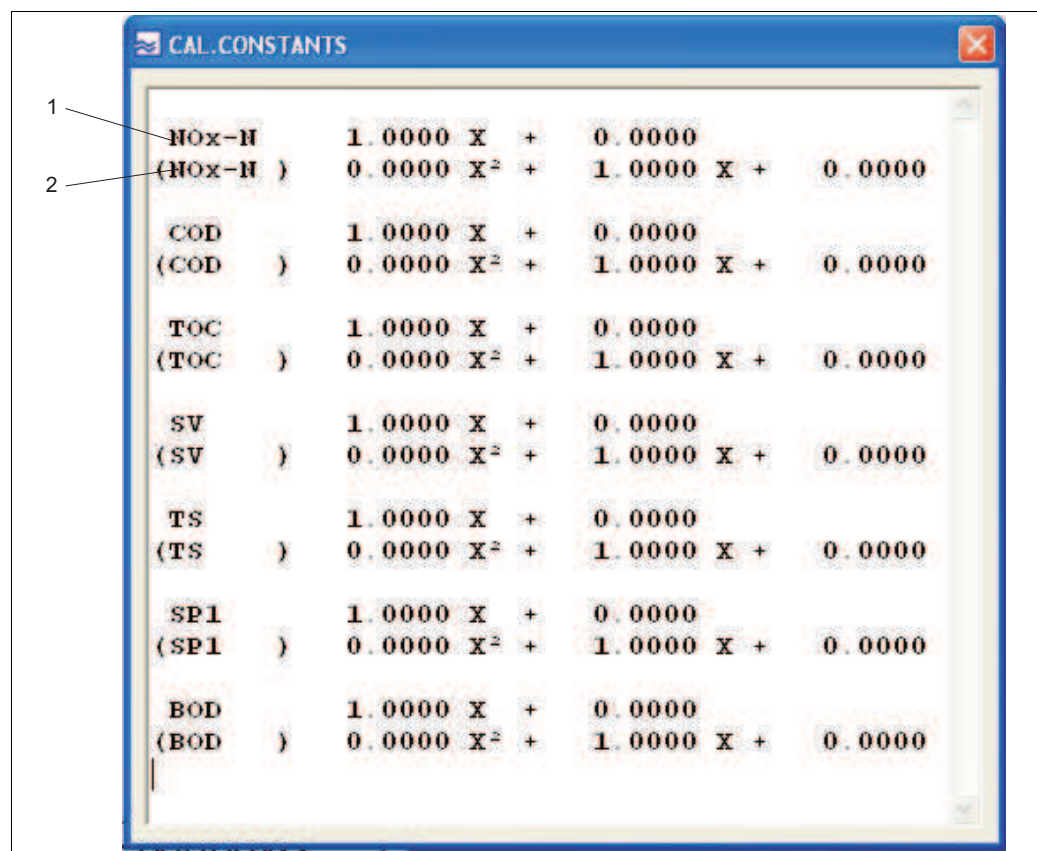

Fig. 43: CAL.CONSTANTS window (before calibration was performed)

- 1 Calibration constants for TARGET/ACTUAL ADJUSTMENT (linear)
- 2 Calibration constants for ENTER MEASURING FUNCTION (quadratic)

## 5.2.4 SETTINGS menu

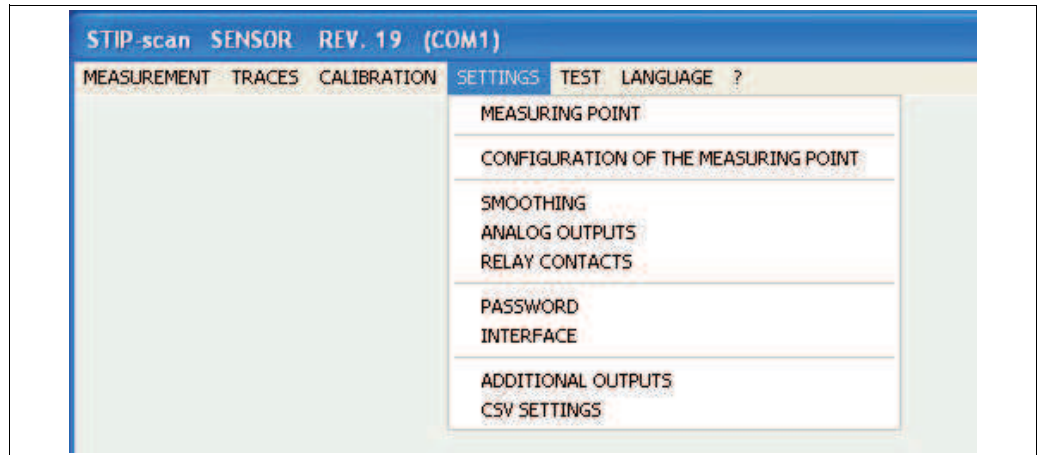

Fig. 44: SETTINGS menu

### NAMING THE MEASURING POINT

In this window you can enter a name for the measuring point. This name appears in the title bar of all windows.

In the **SETTINGS** menu, select the **MEASURING POINT** menu option

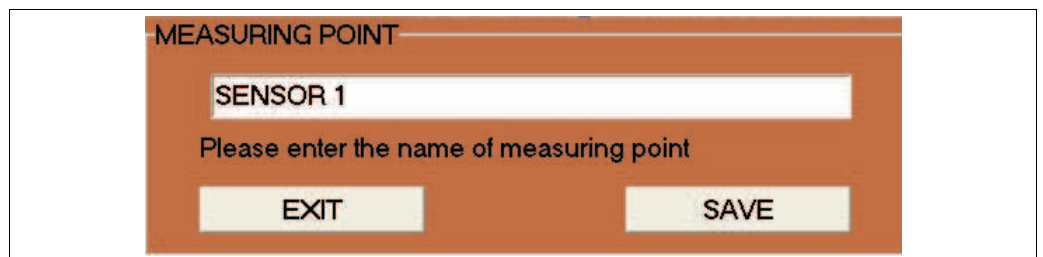

Fig. 45: MEASURING POINT window

Record the name using **SAVE**.

### CONFIGURATION OF THE MEASURING POINT

In this window you configure the measuring point.

In the **SETTINGS** menu, select the **CONFIGURATION OF THE MEASURING POINT.** menu option

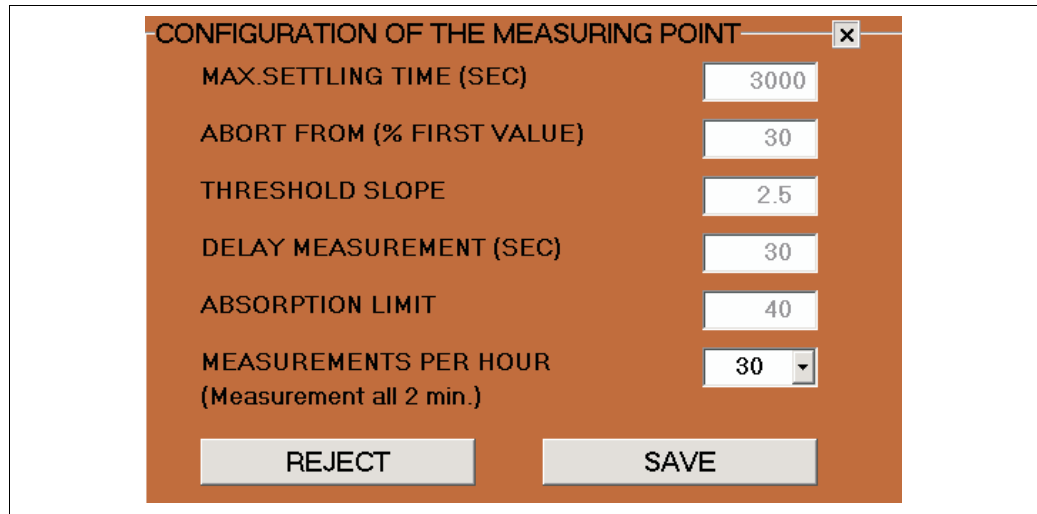

Fig. 46: CONFIGURATION OF THE MEASURING POINT window

Parameter	Range of adjustment	Description
Max. settling time (seconds)	50 to 3000	Enter the maximum time for the sludge to settle. If this time is exceeded, the warning <b>"No sludge settling"</b> is activated. (Can be configured at measuring point: activated sludge basin)
Abort from (% first value)	10 to 70	Here you enter when the observation of the sludge settling is to be suspended and measurement of the slope threshold is to commence (enter as a percentage of the first value). (Can be configured at measuring point: activated sludge basin)
Slope threshold (ppm)	1 to 5	Enter the limit value of the slope for the sludge settling curve. Once the limit value has been reached, analysis of the sludge settling curve is stopped. Once the measurement delay has elapsed, parameter measurement starts. (Can be configured at measuring point: activated sludge basin)
Delay measurement (seconds)	5 to 3000	Enter the delay between sludge settling and the start of measurement. (Configurable at the measuring point: activated sludge basin and inlet)
Absorption limit	15 to 150	Limit value setting for sludge settling; a higher value indicates that settling is quick. (Can be configured at measuring point: sludge activation basin)
Measurements per hour	1, 2, 3, 4, 6, 12, 30	Enter the number of measuring cycles per hour. (Configurable at measuring point: activated sludge basin, inlet and outlet)

## SMOOTHING

In this window you can configure the smoothing of the traces.

In the **SETTINGS** menu, select the **SMOOTHING** menu option.

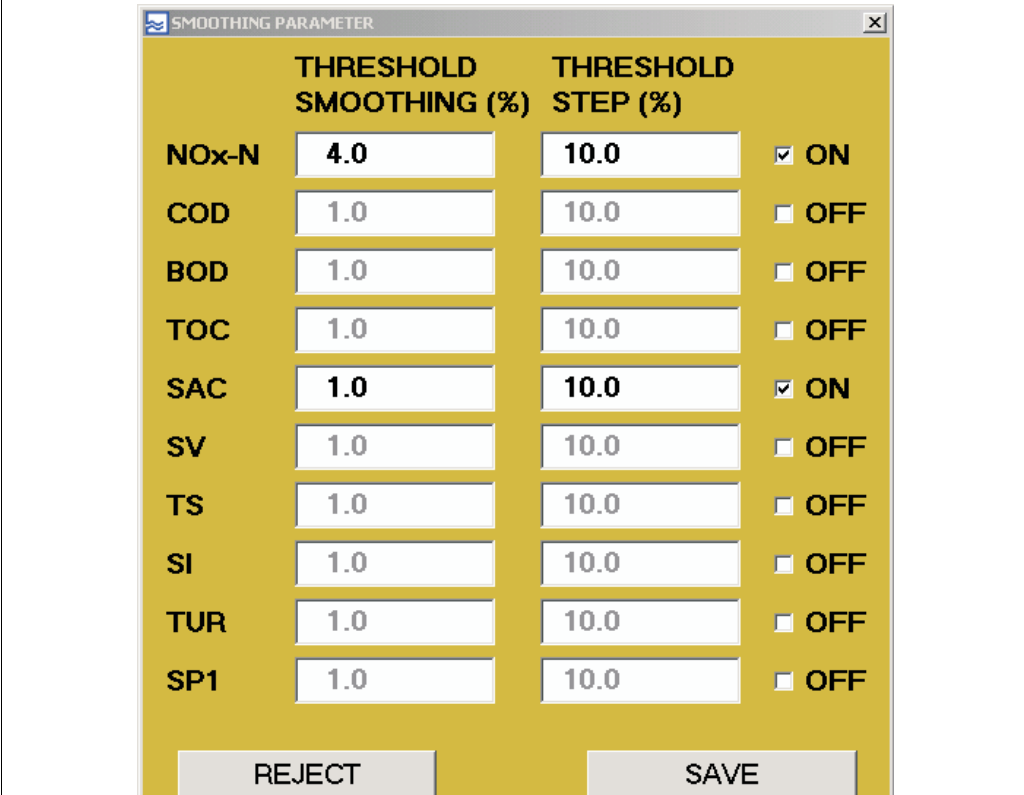

	THRESHOLD SMOOTHING (%)	THRESHOLD STEP (%)	
NO <sub>x</sub> -N	4.0	10.0	<input checked="" type="checkbox"/> ON
COD	1.0	10.0	<input type="checkbox"/> OFF
BOD	1.0	10.0	<input type="checkbox"/> OFF
TOC	1.0	10.0	<input type="checkbox"/> OFF
SAC	1.0	10.0	<input checked="" type="checkbox"/> ON
SV	1.0	10.0	<input type="checkbox"/> OFF
TS	1.0	10.0	<input type="checkbox"/> OFF
SI	1.0	10.0	<input type="checkbox"/> OFF
TUR	1.0	10.0	<input type="checkbox"/> OFF
SP1	1.0	10.0	<input type="checkbox"/> OFF

REJECT      SAVE

Fig. 47: SMOOTHING window

You can make the following settings:

- In the THRESHOLD SMOOTHING(%) column, enter the percentage change in measured value from which the traces are to be smoothed.
- In the THRESHOLD STEP(%) column, enter the percentage change in the case of three consecutive measured values, from which a jump in the trace is to be displayed.
- In the third column, activate the desired parameters.

Example:

- In the case of the NO<sub>x</sub>-N parameter (s. Abb. 47), the trace is smoothed as soon as a change of  $\geq 4$  % occurs between two measured values, and
- a jump appears in the trace as soon as a change of  $\geq 10$  % occurs in three consecutive measured values.

Activate entries using **SAVE**.

## ANALOG OUTPUTS

In this window you can configure the analog outputs.

In the **SETTINGS** menu, select the **ANALOG OUTPUTS** menu option.

The measuring system is equipped with a maximum of two analog modules per sensor. Each module has two analog outputs. These two modules are not interchangeable (bus address).

If no analog module is connected, this menu option cannot be accessed.

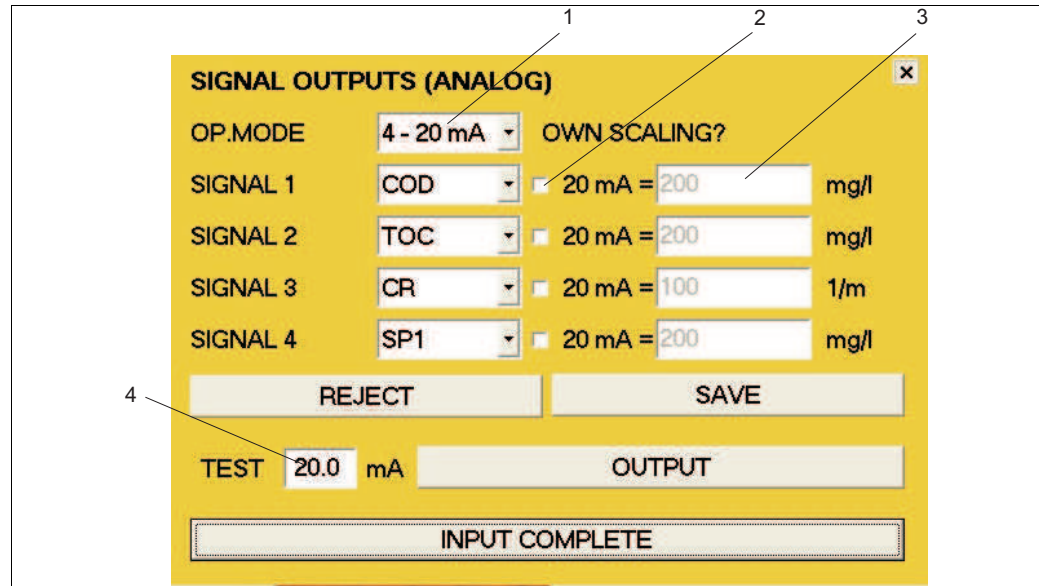

Fig. 48: ANALOG OUTPUTS window

- 1 Selection field 0 - 20 mA or 4 - 20 mA
- 2 Activation field for scaling
- 3 Entry field for scaling
- 4 Entry field for current strength (for test purposes only)

To configure the analog outputs, proceed as follows:

1. In the OP.MODE selection field (pos. 1, Fig. 48), select the desired current range.
2. In the selection fields SIGNAL 1-4, select the desired parameters.
3. If you wish to scale an analog output, activate the corresponding output (pos. 2, Fig. 48).
4. In the entry field (pos. 3, Fig. 48), enter the desired maximum value for the corresponding output.
5. Activate entries using the **SAVE** button.

If scaling is not activated, the factory setting will be used for the maximum value. The **REJECT** button is used to activate the previous settings.

### Functional test for analog outputs

To carry out a functional test on the analog outputs, proceed as follows:

1. Suspend operation.
2. Connect an amperemeter to the relevant analog output.
3. In the relevant SIGNAL 1-4 selection field, select the **TEST** parameter.
4. In the **TEST** entry field (pos. 4, Fig. 48), enter a current value (max. 20 mA).
5. Activate the test using the **OUTPUT** button.
6. Compare the measurement result with the current value entered.

## RELAY CONTACTS

In this window you can configure the relay contacts.

If no digital module is connected, this menu option cannot be accessed.

In the **SETTINGS** menu, select the **RELAY CONTACTS** menu option.

- There are seven relay contacts available.
- The relay contacts function as NC contacts during operation.
- Relay 1 always transmits the measurement status.
- Relay 2 always transmits the leakage signal.
- Relay 3 always transmits the alarm signal from the lamp/spectrometer.
- Relays 4 - 7 can be allocated individually.

For relays 4-7, the following selections are possible:

Signal	Description
GENERIC ALARM 1	The relay opens if one of the following errors occur: <ul style="list-style-type: none"> <li>■ LEAKAGE</li> <li>■ NO LIGHT SIGNAL</li> <li>■ NETWORK FAILURE</li> <li>■ OUTPUT FAILURE (error &amp; warning)</li> <li>■ STEPPER FAILURE</li> <li>■ AIR IN MEASURING CELL (error only)</li> </ul>
GENERIC ALARM 2	The relay opens if one of the following warnings occurs: <ul style="list-style-type: none"> <li>■ NO SLUDGE SETTLING</li> <li>■ ABSORPTION TOO HIGH</li> <li>■ NITRATE VALUE TOO HIGH</li> <li>■ AIR IN MEASURING CELL (warning only)</li> </ul>
NETWORK FAILURE	The relay opens if communication between controller and sensor is suspended.
OUTPUT FAILURE	The relay opens if there is a failure in the data output via the relay contacts or the analog outputs.
STEPPER FAILURE	The relay opens if there is a failure in the stepper.
AIR IN MEASURING CELL	The relay opens if air is detected in the measuring cell.
NITRATE VALUE TOO HIGH	The relay opens if the measuring range is exceeded when measuring nitrate.
COD/TOC/SAC VALUE TOO HIGH	The relay opens if the measuring range is exceeded when measuring COD, BOD, TOC or SAC.
REFERENCE MEASUREMENT	The relay opens when this operating status is reached.
NO <sub>x</sub> VALIDATION	The relay opens when this operating status is reached.
KHP VALIDATION	The relay opens when this operating status is reached.
MEASURING OF CONTAMINATION	The relay opens when this operating status is reached.
MEAS. CELL CONTAMINATED	The relay opens when the contamination measurement exceeds this threshold.
MEAS. CELL HEAVILY CONTAMINATED	The relay opens when the contamination measurement exceeds this threshold.

**RELAY CONTACTS** [X]

RELAY 1 OPERATION

RELAY 2 LEAKAGE

RELAY 3 LAMP/SPECTROMETER FAILURE

RELAY 4 GENERIC ALARM 1

RELAY 5 GENERIC ALARM 2

RELAY 6 AIR IN MEAS.CHAMBER

RELAY 7 AIR IN MEAS.CHAMBER

REJECT SAVE

TEST RELAY 1 CLOSE OPEN

INPUT COMPLETE

Fig. 49: RELAY CONTACTS window

To configure the relay contacts 4-7, proceed as follows:

1. In the RELAY 4 selection field, select the data to be transmitted via this relay.
2. Repeat this for RELAY 5 - 7.
3. Activate entries using the **SAVE** button.

#### Functional test for relays

To carry out a functional test on the relays, proceed as follows:

1. In the **TEST** selection field, select the relevant relay.
2. Confirm the relay using the **CLOSE** and **OPEN** buttons.
3. Test the relay function using a continuity tester or ohmmeter.



## PASSWORD

In this window you can activate the password function.

In the **SETTINGS** menu, select the **PASSWORD** menu option.

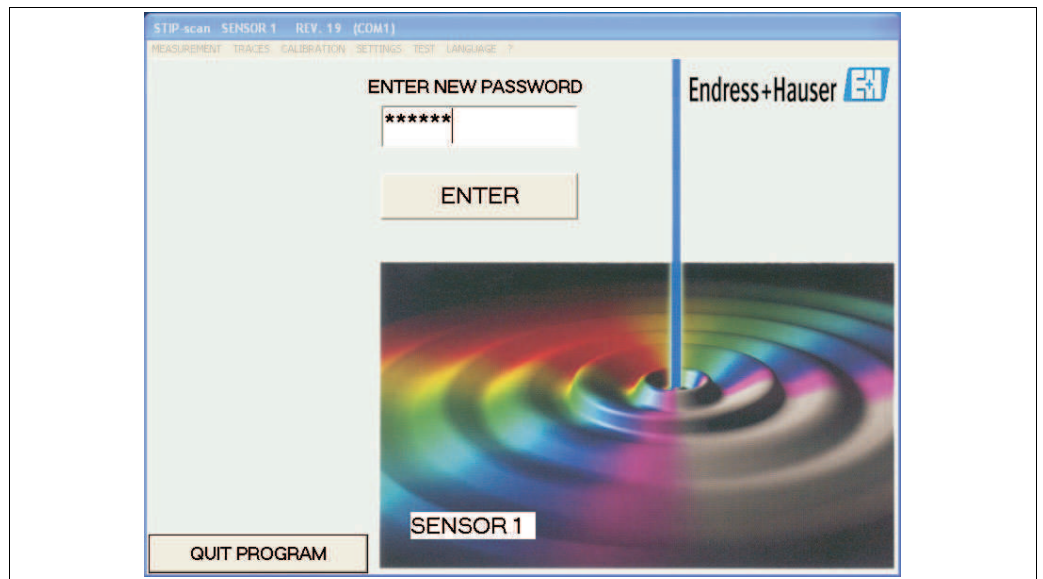

Fig. 50: PASSWORD window

Using this password function you can protect the

- CALIBRATION
- SETTINGS

menus from unauthorized access.



Note!

Once activated, it is no longer possible to deactivate the password function! Deactivation of the password function can be performed only by Endress+Hauser Service.

Activate the password function as follows:

1. For **initial** activation, enter the manufacturer password. The password can be found on the leaflet enclosed with your device.
2. Confirm the password using the **ENTER** button.
3. In the next window enter the new password.
4. Confirm the new password using the **ENTER** button.
5. In the next window enter the new password again.
6. Confirm again using the **ENTER** button.

The password function is now activated. Activation is indicated by a red dot in the upper left-hand corner of the main window.

## INTERFACE

In the **SETTINGS** menu, select the INTERFACE menu option.

In this window you can select the interface:

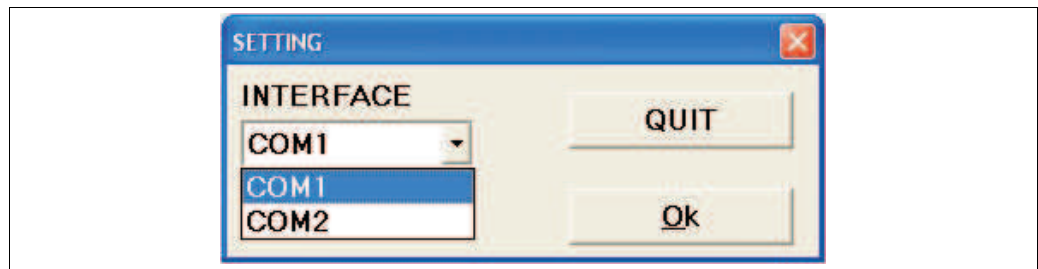

Fig. 51: Selecting the interface

- Check which interface the sensor is connected to.
- For the first sensor select the COM 1 interface and confirm with OK.
- For the second sensor select the COM 2 interface and confirm with OK.

### ADDITIONAL OUTPUTS

In the **SETTINGS** menu, select the **ADDITIONAL OUTPUTS** menu option.  
 In this window you can activate the following options:

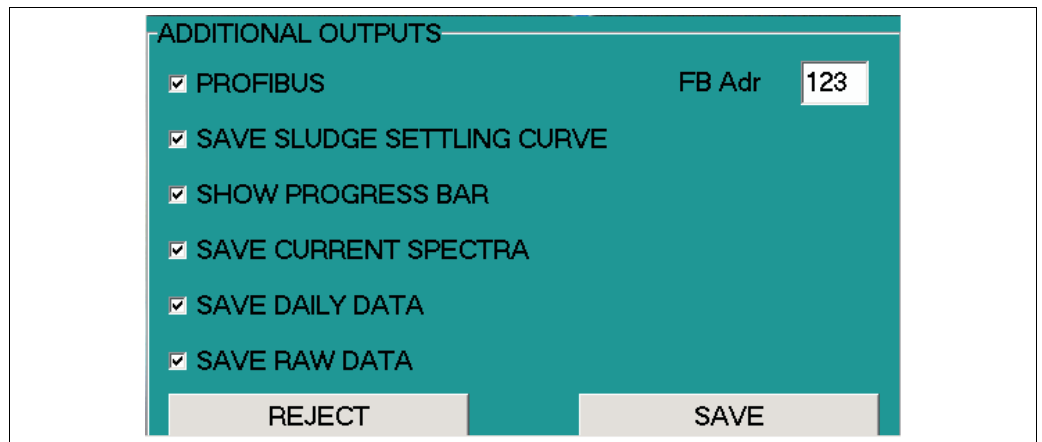

Fig. 52: *ADDITIONAL OUTPUTS* window

a0009512-en

Option	Function
FIELDBUS	Activate the fieldbus connection.
FB Adr	Enter the fieldbus address here.
SAVE SLUDGE CURVES	Activate saving of sludge data to a csv file.
SHOW PROGRESS BAR	Activate the following progress bars in the main window: <ul style="list-style-type: none"> <li>■ Next measurement</li> <li>■ Sludge settling time</li> <li>■ Settling time</li> </ul>
SAVE CURRENT SPECTRUM	Activate saving of the spectrum to a csv file. This function requires a lot of memory!
SAVE DAILY DATA	Activate saving the measured values for an entire day - with the exception of the sludge data - to a csv file.
SAVE RAW DATA	Activate saving of raw data for carbon and nitrate calculation without calibration function. These values are used to determine a measuring function. The data are saved in csv format.

### Save sludge curves

In the **ADDITIONAL OUTPUTS** window, activate the **SAVE SLUDGE CURVE** option. All data for the sludge settling curve (SDA) are saved in csv files on the hard disk of the panel PC.

The following files are created:

- File containing the sludge measurement values for the time hh-mm  
The SDA-hh-mm.csv files are created for each sludge measurement at the actual time in question. They are saved to the following location:  
C:\STIP-scan\SDAJJJ\SDAJJJ-MM\SDAJJJ-MM-TT\SDA\_hh-mm.csv.
- File containing the sludge measurement values for the day JJJJ-MM-TT  
All the sludge data for one day are also saved in one single file. They are saved to the following location: C:\STIP-scan\SDAJJJ\SDAJJJ-MM\SDAJJJ-MM-TT\SDA\_JJJJ-MM-TT.csv.

Explanation of file names:

SDA	sludge data
JJJJ	four-digit year
mm	two-digit month
TT	two-digit day
hh	two-digit hour
mm	two-digit minutes

### Save current spectrum

In the **ADDITIONAL OUTPUTS** window, activate the **SAVE CURRENT SPECTRUM** option. The spectrum for the current measurement and the spectra for KHP and NO<sub>x</sub> validation are saved to a file which can be viewed using Microsoft Excel.

- The file containing the current spectrum is named as follows: AKT\_SPEK\_hh-mm.MES.  
Location: C:\STIP-scan\AKT\_SPEKJJJJ\JJJJ-MM\JJJJ-MM-TT\AKT\_SPEK\_hh-mm.MES
- The file containing the NO<sub>x</sub> validation spectrum is named as follows: AKT\_SPEK\_hh-mm.NOX.  
Location: C:\STIP-scan\AKT\_SPEK\_hh-mm.NOX
- The file containing the KHP validation spectrum is named as follows: AKT\_SPEK\_hh-mm.KHP.  
Location: C:\STIP-scan\AKT\_SPEK\_hh-mm.KHP

### Processing of data using Microsoft Excel

You can convert the csv files to an Excel table and work on them there.

To do so, proceed as follows:

1. Copy the csv files from the hard disk of the panel PC to a USB stick.
2. Copy the csv files from the USB stick to your "Excel computer".
3. Start Microsoft Excel.
4. Open the desired csv file using the **File > Open** menu.



Note!

The csv files have the following factory settings:

- lists separated by a semicolon
- no 1000s separator
- comma used as decimal separator

In the **SETTINGS** menu, select the **CSV SETTINGS** menu option, if you wish to view or change the settings

### Save daily data

In the **ADDITIONAL OUTPUTS** menu, activate the **SAVE DAILY DATA** option.

The measured values for all parameters are saved to the hard disk of the panel PC in a day file called DAJJJMMTT.csv.

The day files are stored in the relevant month folder MDAJJJMM.

Location: C:\STIP-scan\MDAJJJMM\DAJJJMMTT.csv

Explanation of file names:

MDA	month data
DA	data
JJJJ	four-digit year
MM	two-digit month
TT	two-digit day

### CSV SETTINGS

In the **SETTINGS** menu, select the **CSV SETTINGS** menu option.

In this window you can determine the following:

- Date format
- Column separator
- Decimal separator

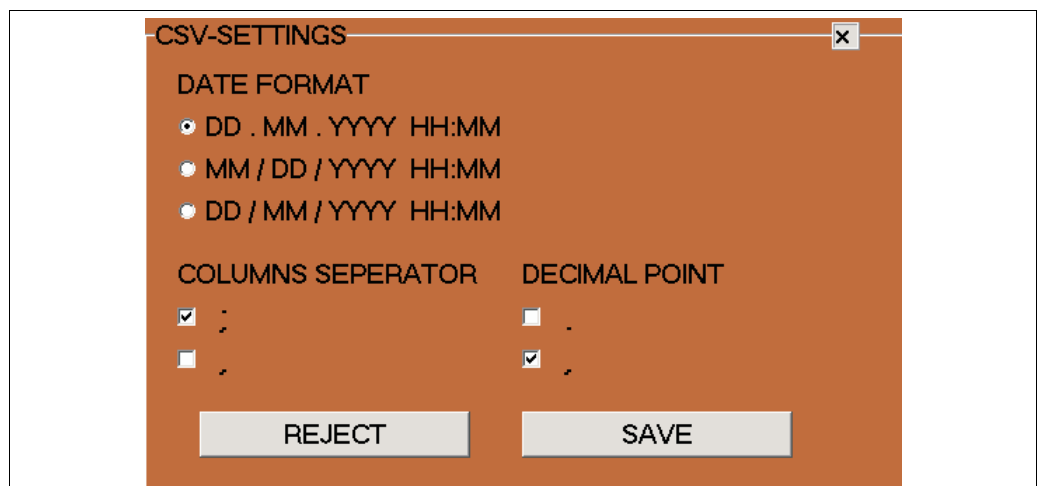

Fig. 53: CSV SETTINGS window

Activate the settings using **SAVE**.

## 5.2.5 TEST menu

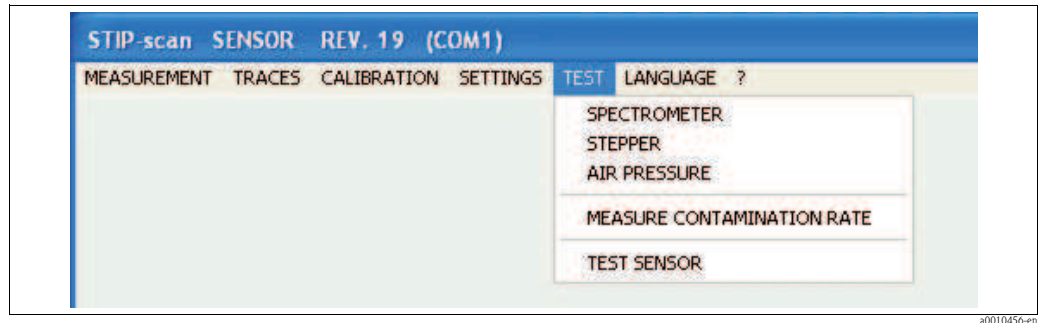

Fig. 54: TEST menu

### SPECTROMETER

This menu option is used to test the function of the spectrometer. In the **TEST** menu, select the **SPECTROMETER** menu option.

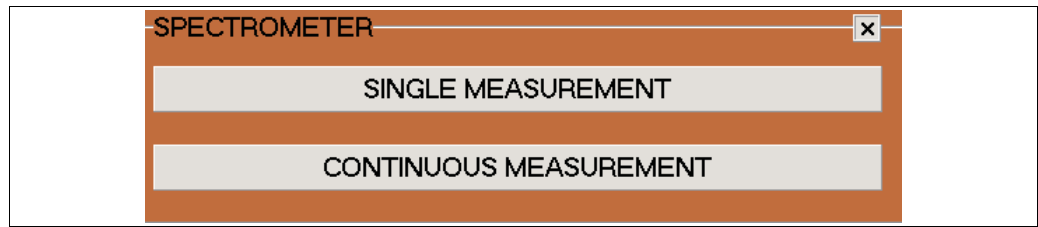

Fig. 55: SPECTROMETER window

- Start single measurement using the **SINGLE MEASUREMENT** button. The **SPECTRUM** window opens automatically.
- Start continuous measurement using the **CONTINUOUS MEASUREMENT** button. The button now appears in red. The **SPECTRUM** window opens automatically. If you activate the **OVERLAP CURVES** function in the **SPECTRUM** window, the measurement curves for each measurement are shown in this one graph. You can stop continuous measurement by pressing the **CONTINUOUS MEASUREMENT** button again.

### STEPPER

In the **TEST** menu, select the **STEPPER** menu option.

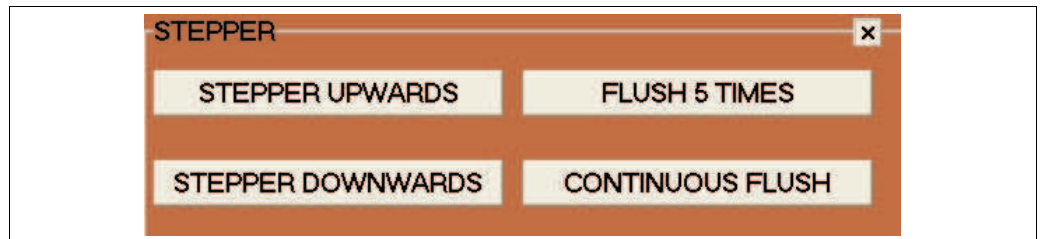

Fig. 56: STEPPER window

Button	Function
STEPPER UPWARDS	The piston travels all the way to the top. The sensor is filled completely with medium.
STEPPER DOWNWARDS	The piston travels all the way to the bottom. The sensor is emptied completely.
FLUSH 5 TIMES	The piston travels up and down 5 times. Use this function to clean or flush the sensor using distilled water or cleaning solution.
CONTINUOUS FLUSH	The piston travels up and down continuously. To stop continuous flushing, press the CONTINUOUS FLUSH button again. While this function is active, the button is highlighted in red.

### AIR PRESSURE

In the **TEST** menu, select the **AIR PRESSURE** menu option.

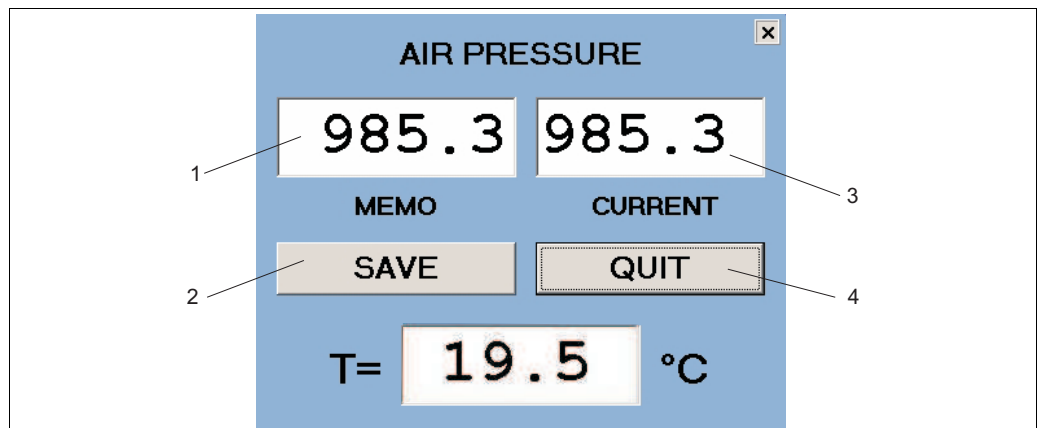

Fig. 57: AIR PRESSURE window

- 1 MEMO - displays the air pressure value saved
- 2 Button for saving the current air pressure
- 3 CURRENT - displays the current air pressure
- 4 Button to close the AIR PRESSURE window

## MEASURE CONTAMINATION RATE

This menu option is used to measure the contamination level of the sensor.  
In the **TEST** menu, select the **MEASURE CONTAMINATION RATE** menu option.  
Measurement takes several minutes and cannot be interrupted.

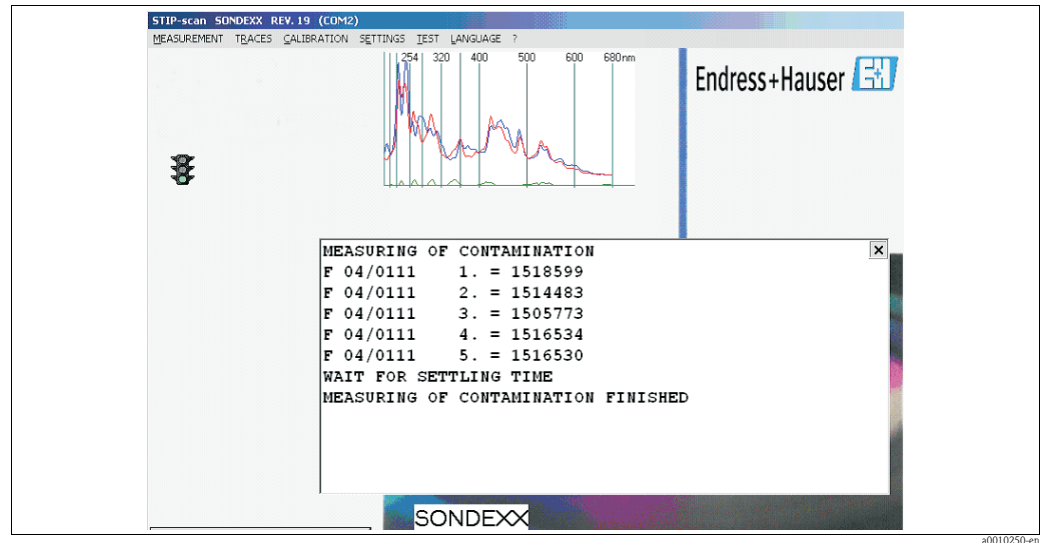

Fig. 58: MEASURE CONTAMINATION RATE, result

If the **CR** parameter is activated in the **MEASUREMENT > CURRENT PARAMETERS** menu, the contamination rate is measured automatically every 6 hours (0:00, 6:00, 12:00 and 18:00 hours).

The contamination rate is also indicated by a traffic light. If the first threshold value is exceeded, the traffic light switches to yellow. If the second threshold value is exceeded, the traffic light switches to red. Measurement continues in both cases.

You can configure one relay output for threshold value overshoot.



## TEST SENSOR

This menu option is used to test the functional capability of the entire system. In the **TEST** menu, select the **TEST SENSOR** menu option.

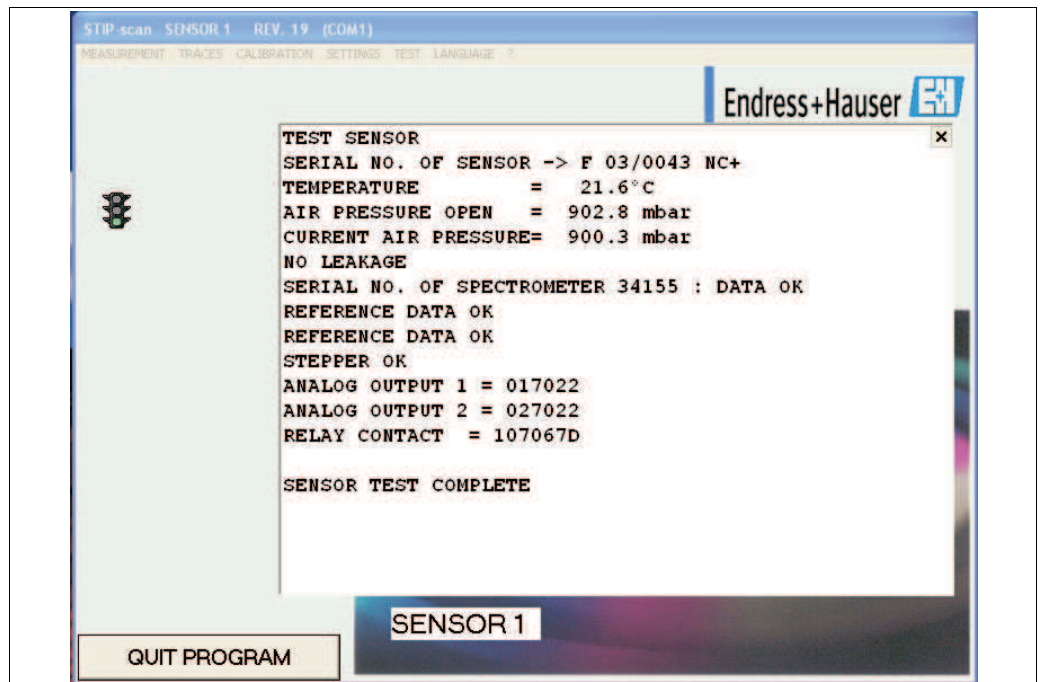

Fig. 59: TEST SENSOR, result

The following information is listed:

- The serial number of the sensor with the associated module type
- Temperature of the sensor interior
- Air pressure when the sensor is open (no overpressure in sensor interior)
- Current air pressure in the sensor (after pressurization)
- Message from leakage sensor (here: NO LEAKAGE)
- Serial number and status of spectrometer
- Status of reference data
- Status of stepper
- Testing the analog signal outputs (display of module series)
- Testing of relay contacts (display of module series)
- End of system test

This system test is also carried out automatically at each system startup.

## 5.2.6 LANGUAGE menu

Select the **LANGUAGE** menu.

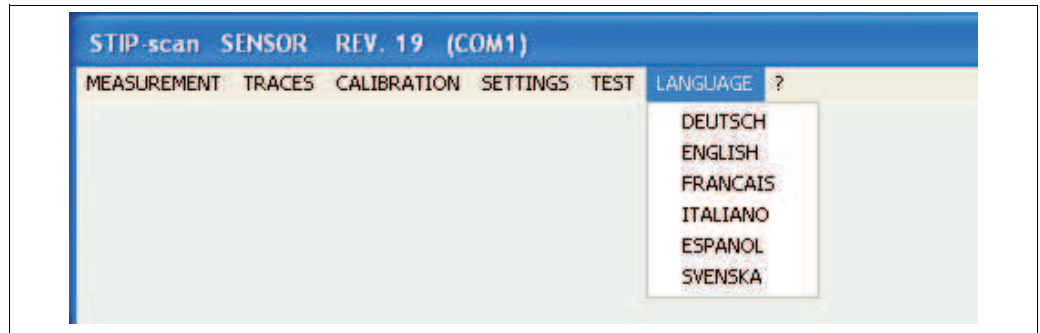

Fig. 60: LANGUAGE menu

Click on the desired language.

## 6 Commissioning

### 6.1 Installation and functional check



Warning!

- Check all connections for correctness.
- Make sure that the supply voltage is identical to the voltage indicated on the nameplate!

### 6.2 Quick setup

After power-up you must make a few settings to configure the most important transmitter functions which are necessary to ensure correct measurement.

1. In the **LANGUAGE** menu, select the desired language.
2. In the **SETTINGS** menu, select the **INTERFACE** menu option. Select **COM1** for the first sensor and **COM2** (if available) for the second sensor.
3. Carry out a leakage test (see "Maintenance" section).
4. In the **MEASUREMENT** menu, select the **CURRENT PARAMETERS** menu option. Activate the parameters to be measured.
5. In the **MEASUREMENT** menu, select the **MONITORING SITE** menu option. Enter the location of the sensor.
6. Configure the analog outputs (if available).  
In the **SETTINGS** menu, select the **ANALOG OUTPUTS** menu option. Select the mode of operation and the parameters.
7. Configure the relay outputs (if available).  
In the **SETTINGS** menu, select the **RELAY OUTPUTS** menu option.  
Relay1 to Relay3 are allocated as follows:
  - Relay1 = Operation
  - Relay2 = Leakage
  - Relay3 = Lamp/spectrometer failure
 Relay4 to Relay7 can be individually allocated.
8. Perform a 10-minute stepper test (sensor hanging in water):
  - a. In the **TEST** menu, select the **STEPPER** menu option.
  - b. Click on the **CONTINUOUS FLUSH** button.
  - c. Stop the test after 10 minutes by clicking again on the **CONTINUOUS FLUSH** button.
9. Start measurement:  
In the **MEASUREMENT** menu, select the **START MEASUREMENT** menu option. Allow the system to run for an entire day.

## 6.3 Communication

The panel PC must be fitted with a fieldbus card (CAM74-1\*\*B\*\*\*).

For fieldbus communication with the measuring system, PROFIBUS is used with the DPV1 or DPV0 protocols. The measuring system behaves like a PROFIBUS standard slave. Any device compatible with PROFIBUS DPV1 or DPV0 can be used as a master (e.g. SIMATIC S5 or SIMATIC S7).

The PROFIBUS partner is defined by the device database (GSD file) from Hilscher. Integration into the PROFIBUS network takes place as follows:

- in the case of the SIMATIC S5 via the "COM-PROFIBUS" program
- in the case of the SIMATIC S7 through integration into the hardware configuration of the SIMATIC Manager.

### Configure address

In the **SETTINGS** menu, select the **ADDITIONAL OUTPUTS** menu option.

In this window you can activate the PROFIBUS connection and configure the address.



Note!

This setting is used to initialize the PROFIBUS device when starting the program. If the address is changed, the PROFIBUS device is initialized again.

The factory setting for the PROFIBUS address is 123. If you are already using this address, change the address before connecting the transmitter to your network.

## Data structure

Detailed information using the example of the Siemens S7:

Parameter	Description (1 <sup>st</sup> sensor)	Description (2 <sup>nd</sup> sensor)
NOx	tiOSendData[0] = byte1 tiOSendData[1] = byte2 tiOSendData[2] = byte3 tiOSendData[3] = byte4	tiOSendData[36] = byte1 tiOSendData[37] = byte2 tiOSendData[38] = byte3 tiOSendData[39] = byte4
COD or TOC or BOD	tiOSendData[4] = byte1 tiOSendData[5] = byte2 tiOSendData[6] = byte3 tiOSendData[7] = byte4	tiOSendData[40] = byte1 tiOSendData[41] = byte2 tiOSendData[42] = byte3 tiOSendData[43] = byte4
Special parameter 1	tiOSendData[8] = byte1 tiOSendData[9] = byte2 tiOSendData[10] = byte3 tiOSendData[11] = byte4	tiOSendData[44] = byte1 tiOSendData[45] = byte2 tiOSendData[46] = byte3 tiOSendData[47] = byte4
SAC	tiOSendData[12] = byte1 tiOSendData[13] = byte2 tiOSendData[14] = byte3 tiOSendData[15] = byte4	tiOSendData[48] = byte1 tiOSendData[49] = byte2 tiOSendData[50] = byte3 tiOSendData[51] = byte4
Sludge volume	tiOSendData[16] = byte1 tiOSendData[17] = byte2 tiOSendData[18] = byte3 tiOSendData[19] = byte4	tiOSendData[52] = byte1 tiOSendData[53] = byte2 tiOSendData[54] = byte3 tiOSendData[55] = byte4
Total solids	tiOSendData[20] = byte1 tiOSendData[21] = byte2 tiOSendData[22] = byte3 tiOSendData[23] = byte4	tiOSendData[56] = byte1 tiOSendData[57] = byte2 tiOSendData[58] = byte3 tiOSendData[59] = byte4
Sludge index	tiOSendData[24] = byte1 tiOSendData[25] = byte2 tiOSendData[26] = byte3 tiOSendData[27] = byte4	tiOSendData[60] = byte1 tiOSendData[61] = byte2 tiOSendData[62] = byte3 tiOSendData[63] = byte4
ATU	tiOSendData[28] = byte1 tiOSendData[29] = byte2 tiOSendData[30] = byte3 tiOSendData[31] = byte4	tiOSendData[64] = byte1 tiOSendData[65] = byte2 tiOSendData[66] = byte3 tiOSendData[67] = byte4
Statuses	tiOSendData[32] = byte1 tiOSendData[33] = byte2 tiOSendData[34] = byte3 tiOSendData[35] = byte4	tiOSendData[68] = byte1 tiOSendData[69] = byte2 tiOSendData[70] = byte3 tiOSendData[71] = byte4

The sum of the bytes transmitted is 36. For versions with two sensors the sum of bytes transmitted is 72 (also if only one sensor is connected). Ensure that the same number of bytes is retrieved in the control unit. In the case of the Siemens S5, the sum of the bytes transmitted is 20.

Parameters	Description
Operating statuses	0x80000000 // in operation 0x00000001 // measuring mode 0x00000002 // ref measurement 0x00000004 // NOx validation 0x00000008 // KHP validation 0x00800000 // contamination rate measurement
Error	0x00000010 // leakage 0x00000020 // light outage 0x00000040 // network failure 0x00000080 // output failure 0x00000100 // stepper failure 0x00000200 // air in sensor 0x00000800 // no valid reference
Warnings	0x00001000 // sludge not settling 0x00002000 // absorption too high 0x00004000 // nitrate value too high 0x00008000 // air in sensor 0x00010000 // CR warning, yellow traffic light 0x00020000 // CR alarm, red traffic light

The values of the Siemens S5 are in the same order. However, when transmitting the analog values, only 2 bytes are used instead of 4. The following addresses relocate accordingly. In the case of the S5, the data are transmitted in the form of an "Unsigned Integer" (2 bytes). In the case of the S7, the data are transmitted as floating-point numbers in "Real Format" in accordance with IEEE-FP-32. The factory setting is S7 which means that 4-byte values are transmitted.



Note!

If you want to connect the transmitter to an S5, contact E+H Service or inform your E+H sales representative beforehand.

### Integration with SIMATIC S7

Integrate the transmitter with the SIMATIC S7 as follows::

1. Install the GSD file.
2. Add a new slave to your hardware configuration and assign it an address in your network.

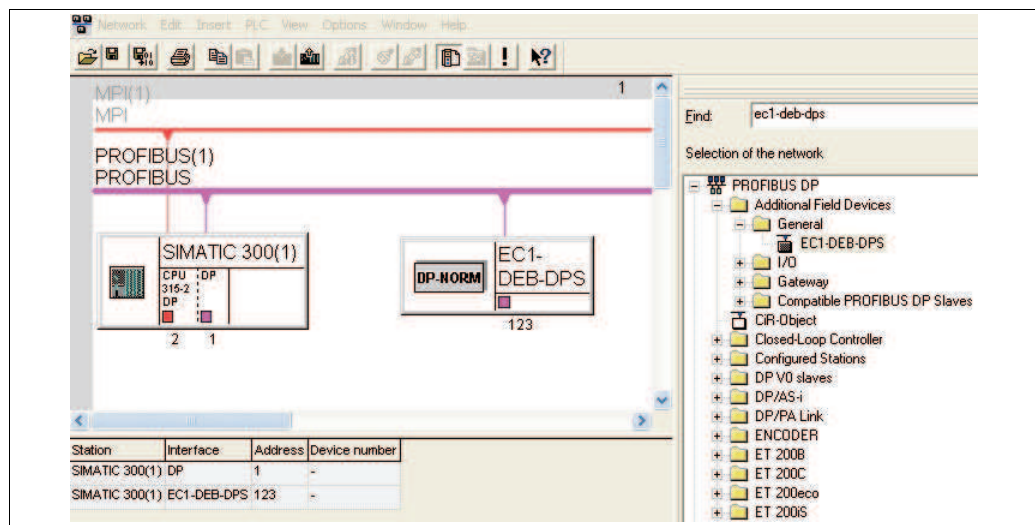

Fig. 61: User interface SIMATIC S7

- Retrieve the transmitter data. 9x4 bytes are retrieved as 4 byte input con (0x93). Address allocation starts at 0.

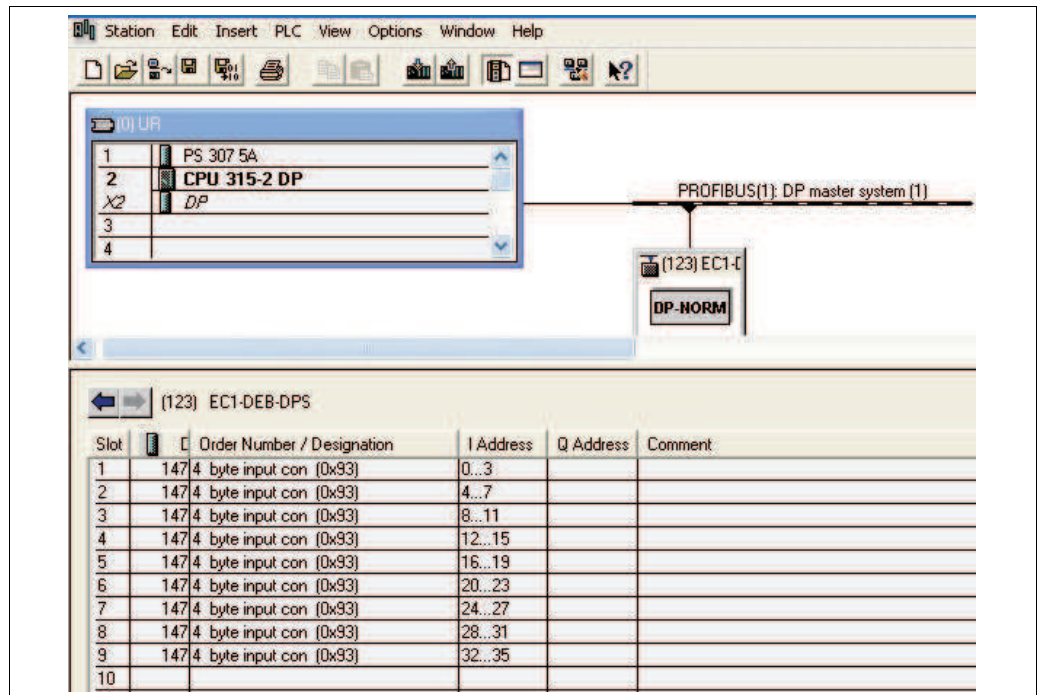

Fig. 62: SIMATIC S7 user interface

The data are now available for processing in the SIMATIC S7.

## 7 Maintenance

Take all necessary measures in time to ensure the operational safety and reliability of the entire measuring system.

Depending on the application, carry out maintenance work at least once a month.

Maintenance work on the device includes the following:

- Cleaning the cell
- Visual inspection of sensor housing
- Visual inspection of inlet
- Leakage test
- Review of warning and error messages



Warning!

There is a risk of infection when working with wastewater!

Therefore, wear protective gloves, goggles and protective clothing.

### 7.1 Maintenance of complete measuring point

#### 7.1.1 Cleaning the transmitter

Clean the front of the housing with usual commercial cleaning agents.

In accordance with DIN 42 115, the front is resistant to:

- Isopropanol
- Diluted acids (max. 3%)
- Diluted alkalis (max. 5%)
- Esters
- Hydrocarbons
- Ketones
- Household cleaners



Caution!

For cleaning purposes, never use:

- Concentrated mineral acids or alkalis
- Benzyl alcohol
- Methylene chloride
- High-pressure steam

#### 7.1.2 Cleaning the sensor

Clean the cell as follows:

1. Place the sensor in a container of distilled water.
2. In the **TEST** menu, select the **STEPPER** menu option.
3. Click on the **FLUSH 5 TIMES** button.
4. When the flushing process has been completed, click on the **DOWNWARDS** button.



Note!

For dirt that is hard to remove, use a cleaning solution (depending on the type of contamination involved use 5% hydrochloric acid or 5% sodium hydroxide). Following this you must repeat the flushing processes using distilled water.



### 7.1.3 Leakage test

For the leakage test, an overpressure of approx. 300 mbar (approx. 4.5 psi) is generated in the sensor. The drop in pressure is then measured. The drop in pressure within a period of 15 minutes must not exceed 5 mbar.

For the leakage test you will need an air pump (included in the scope of supply).

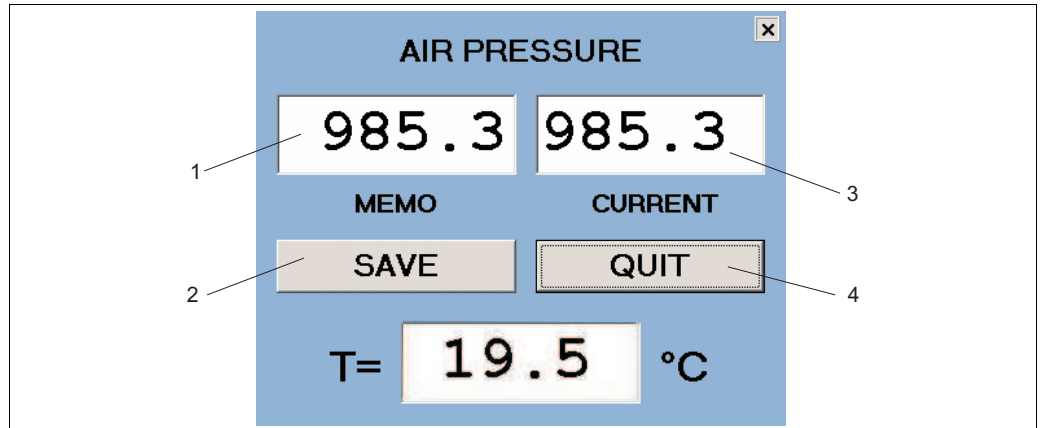

Fig. 63: AIR PRESSURE window

- 1 MEMO - recorded air pressure value
- 2 Button for recording the current air pressure
- 3 ACTUAL - current air pressure
- 4 Button - to close the window

Prepare for the leakage test as follows:

1. Ensure that the connecting cable has been installed correctly.
2. In the **TEST** menu, select the **AIR PRESSURE** menu option.

Carry out the leakage test as follows:

1. Pump air into the sensor using the air pump (included in the scope of supply) until the **CURRENT** value is approx. 300 mbar above the **MEMO** value.
2. Save the current air pressure. **MEMO** and **CURRENT** now both display the same value.
3. After 15 minutes check the **CURRENT** value.

Drop in pressure < 5 mbar	Sensor is airtight.
Drop in pressure > 5 mbar	Sensor is <b>not</b> airtight.

If the sensor is not airtight, contact E+H Service.

## 8 Accessories

### Supporting arms

- complete set 700 mm; supplement to 71013968; stainless steel 1.4301 (AISI 304)
- order no. 71013964

### Wall mounting for transmitter and one sensor

- stainless steel 1.4301 (AISI 304)
- order no. 71013961

### Mounting material

- mounting material for wall mounting of the transmitter (stainless steel version)
- order no. 71013971

### Stand and mounting material for transmitter and one sensor

- stainless steel 1.4301 (AISI 304)
- order no. 71013970

### Stand and mounting material for one sensor

- for second measuring position; stainless steel 1.4301 (AISI 304)
- order no. 71013968

### Flow through assembly

- for bypass applications with open drain
- material: stainless steel 1.4571 (AISI 316 Ti)
- order no. 71013995

### Sample reservoir chamber

- dimensions: 540 x 500 x 300 mm (21.3" x 19.7" x 11.8")
- for 1 or 2 sensors
- material: stainless steel 1.4571 (AISI 316 Ti)
- order no. 71013929

### Weather protection roof for aluminum version of CAM74

- mandatory for outside use
- dimensions: 370 x 470 x 455 mm (14.6" x 18.5" x 17.9")
- material: polycarbonat (PC)
- order no. 71092182

## 9 Troubleshooting

### 9.1 Warnings

The following warnings (shown in yellow) may occur without disrupting measurement:

Warning	Possible cause	Corrective measures
NO SLUDGE SETTLING	The sludge is not settling. For this reason, it is not possible to determine any further sludge parameters.	Increase the sludge settling time (SETTINGS menu).
ABSORPTION TOO HIGH	Absorption (average value within the wavelength range of evaluation) following the settling process is $> 250 \text{ m}^{-1}$ .	none
NITRATE VALUE TOO HIGH	The nitrate value is $> 23 \text{ mg/l}$ . Above this value, the measuring system returns values which are too inaccurate.	none
AIR IN MEASURING CELL	Air has entered the measuring chamber (e.g. as a result of a drop in the water level). If the air has not escaped following four measurement attempts, the warning is replaced by an error message, and operation is suspended.	Lower the sensor a little deeper into the wastewater so that air can no longer enter the measuring cell.

## 9.2 Error messages

Operation is suspended in the case of the following error messages (shown in red):

Error message	Possible cause	Corrective measures
NETWORK FAILURE	The transmitter cannot establish communication with the sensor. The connection between the control line and the sensor or the transmitter is not correct.	Check the communication interface, the RS232/RS485 converter (LED must be lit) and the control line. Are all cables connected? Contact E+H Service if necessary.
NO COM PORT AVAILABLE	When starting the STIP-scan software program, no COM interface was identified.	Check to see which interface the sensor cable is connected to. Does this match the entry in the SETTINGS > INTERFACE menu? Contact E+H Service if necessary.
LEAKAGE	The leakage sensor signals that there is water in the sensor.	Contact E+H Service. Carefully remove the sensor from the water and store it in an upright position until a service representative arrives.
NO LIGHT SIGNAL	If there is a fault in the lamp, the high-voltage generator or the spectrometer, there can be no measuring signal.	Contact E+H Service.
OUTPUT FAILURE	There is a fault in the analog outputs or the relay contacts.	Contact E+H Service.
STEPPER FAILURE	There is a fault in the motor (e.g. piston seal is damaged).	Contact E+H Service.
NO VALID REFERENCE	There was a failure in the reference measurement using distilled water.	Contact E+H Service.
AIR IN MEASURING CELL	Air has entered the measuring chamber (e.g. as a result of a drop in the water level).	Lower the sensor a little deeper into the wastewater. Contact E+H Service if necessary.

### 9.3 Spare parts

Description and contents	Order number Spare parts kit
Protective flange; 3 socket head cap screws M4x8; molded seal 18 x 60 x 0.5 EPDM	71061363
Flow assembly; 3 socket head cap screws M4x8; molded seal 18 x 60 x 0.5 EPDM	71061365
Connecting clip with sealing ring	71061366

### 9.4 Return

If a repair is needed, please *clean* the sensor and return it to your sales office. When returning the item, please use the original packaging.

Please enclose the completed "Declaration of hazardous material and de-contamination" (copy the second last page of these Operating Instructions) in the packaging together with the dispatch documents. No repairs can be carried out without a completed declaration!

### 9.5 Disposal

The device contains electronic components and must therefore be disposed of in accordance with regulations on the disposal of electronic waste. Please observe local regulations.

## 10 Technical Data

### 10.1 Input

<b>Measuring range</b>	NO <sub>x</sub> -N COD equivalent BOD equivalent TOC equivalent SAC <sub>254</sub> Sludge TS SV SI ATU	0.3 to 23 mg/l 10 to 2000 mg/l <sup>1)</sup> 10 to 2000 mg/l <sup>1)</sup> 4 to 800 mg/l <sup>1)</sup> 1 to 250 m <sup>-1</sup> 0.5 to 5.0 g/l 100 to 900 mL/l <sup>2)</sup> corresponds to SV divided by sludge TS 1 to 200 m <sup>-1</sup>
<b>Wavelength</b>	200 to 680 nm	
<b>Cable specification</b>	max. 20 m (65.6 ft.)	

1) based on KHP (kalium hydrogen phthalate)

2) undiluted sample

### 10.2 Output

<b>Output signal</b>	0/4 to 20 mA	
<b>Accuracy</b>	±0.1 % of end of measuring range	
<b>Burden</b>	max. 500 Ω	
<b>Resolution</b>	±0.02 % of end of measuring range	
<b>Insulating strength</b>	max. 3000 V DC	
<b>Relay</b>	Quantity Switching current	7 NO contacts 0.5 A at 120 V AC / 1.0 A at 24 V DC
<b>Converter</b>	Transmission rate Insulating strength	115200 Bit/s max. 3000 V DC
<b>PROFIBUS</b>	Type Protocol I/O memory	PROFIBUS DP slave DP-V0 or DP-V1 (class 1/2) 368 byte

### 10.3 Power supply

<b>Supply voltage</b>	115/230 V 50/60 Hz (stainless steel version) 100 to 250 V 50 to 60 Hz (aluminum version)
<b>Power consumption</b>	approx. 130 VA

## 10.4 Performance characteristics

<b>Measured value resolution</b>	NO <sub>x</sub> -N COD equivalent BOD equivalent TOC equivalent SAC <sub>254</sub>	0.1 mg/l 2 mg/l 2 mg/l 1 mg/l 0.1 m <sup>-1</sup>
<b>Measuring interval</b>	Inlet and outlet Activated sludge basin	2 to 60 min depending on sludge composition
<b>Repeatability</b>	max. 3 % of the full-scale value for the parameters NO <sub>x</sub> -N, COD, BOD, TOC, SAC	
<b>Response time</b>	120 s (depending on the application; larger intervals can be selected)	

## 10.5 Environment

<b>Ambient temperature range</b>	-10 to +40 °C (+14 to 104 °F) (transmitter in enclosed weatherproof housing)	
<b>Degree of protection</b>	Sensor (when housing is closed) Transmitter as stainless steel version (closed at the front) Transmitter as stainless steel version (open at the front) Transmitter as aluminum version	IP67 IP65 IP55 IP65

## 10.6 Process

<b>Process temperature range</b>	0 to 30 °C (32 to 86 °F) If the temperature of the medium > 30 °C, a separate application test is necessary!
<b>Process pressure range</b>	0 to 0.3 bar (4.4 psi) overpressure
<b>Particle size</b>	< 1 mm
<b>Solids content</b>	< 5 g/l (< 5000 ppm)
<b>Sludge volume SV</b>	max. 750 ml/l for undiluted sample after 30 min

## 10.7 Mechanical construction

<b>Dimensions</b>	Transmitter (stainless steel version)  Transmitter (aluminum version)  Sensor	W x H x D: 520 x 520 x 260 mm (20.5" x 20.5" x 10.2") W x H x D: 327 x 273 x 180 mm (12.87" x 10.75" x 7.1") L = approx. 600 mm (23.6"); Ø = 129 mm (5.08")
<b>Weight</b>	Transmitter (stainless steel version) Transmitter (aluminum version) Sensor	approx. 31 kg (68 lbs) approx. 7.7 kg (17 lbs) approx. 8.3 kg (18.3 lbs)
<b>Material</b>	Transmitter (stainless steel version) Transmitter (aluminum version) Sensor (body) Sensor holder	stainless steel 1.4301 (AISI 304) aluminum casting stainless steel 1.4571 (AISI 316 Ti) stainless steel 1.4571 (AISI 316 Ti)

# Index

## A

Accessories . . . . .	66
Additional outputs . . . . .	51
Air pressure . . . . .	55
Analog outputs . . . . .	46

## C

Calibration constants . . . . .	42
Check	
Electrical connection . . . . .	24
Installation and function . . . . .	59
Checking	
Installation . . . . .	15
Cleaning	
Sensor . . . . .	64
Transmitter . . . . .	64
Commissioning . . . . .	4, 59
Communication . . . . .	60
Configuration of the measuring point . . . . .	44
Connection	
Transmitter (aluminum version) . . . . .	20
Transmitter (stainless steel version) . . . . .	16
CSV settings . . . . .	53
Current parameters . . . . .	27
Current trace . . . . .	29

## D

Declaration of conformity . . . . .	8
Designated use . . . . .	4
Display . . . . .	25
Disposal . . . . .	69

## E

Electrical connection . . . . .	16
Electrical icons . . . . .	5
Enter measuring function . . . . .	39
Error messages . . . . .	68

## F

Flow assembly	
Installation . . . . .	15

## I

Icons . . . . .	5
Electrical . . . . .	5
Immunity to interference . . . . .	4
Incoming acceptance . . . . .	9
Installation . . . . .	4, 9–11
Flow assembly . . . . .	15
Sensor . . . . .	14
Upright post . . . . .	11
Wall bracket . . . . .	13
Interface . . . . .	50

## K

KHP VALIDATION . . . . .	40
--------------------------	----

## L

Leakage test . . . . .	65
------------------------	----

## M

Maintenance . . . . .	64
Complete measuring point . . . . .	64
Leakage test . . . . .	65
Measuring point . . . . .	64
Measure contamination rate . . . . .	56
Measured values . . . . .	36
Menu	
Additional outputs . . . . .	51
Air pressure . . . . .	55
Analog outputs . . . . .	46
Calibration . . . . .	38
Calibration constants . . . . .	42
Configuration of the measuring point . . . . .	44
CSV settings . . . . .	53
Current parameters . . . . .	27
Current trace . . . . .	29
Enter measuring function . . . . .	39
Interface . . . . .	50
KHP VALIDATION . . . . .	40
Language . . . . .	58
Measure contamination rate . . . . .	56
Measured values . . . . .	36
Measurement . . . . .	26
Monitoring site . . . . .	28
Naming the measuring point . . . . .	43
NOx validation . . . . .	40
Password . . . . .	49
Relay contacts . . . . .	47
Settings . . . . .	43
Show historical traces . . . . .	33
Single measurement . . . . .	32
Sludge settling curve . . . . .	36
Smoothing . . . . .	45
Spectrometer . . . . .	54
Stepper . . . . .	55
Take sample spectra . . . . .	41
Target/actual adjustment . . . . .	39
Test . . . . .	54
Test sensor . . . . .	57
Trace pollution . . . . .	37
TRACES . . . . .	29
Menu	
Start measurement . . . . .	26
Monitoring site . . . . .	28

## N

Nameplate . . . . .	6
Naming the measuring point . . . . .	43
NOx validation . . . . .	40



<b>O</b>	
Operation . . . . .	4, 25–26
Operational safety . . . . .	4
Output . . . . .	70
<b>P</b>	
Password . . . . .	49
Post-connection check . . . . .	24
Power supply . . . . .	70
PROFIBUS . . . . .	60
<b>Q</b>	
Quick commissioning . . . . .	59
Quick setup. . . . .	59
<b>R</b>	
Relay contacts. . . . .	47
Return . . . . .	5, 69
<b>S</b>	
Safety icons. . . . .	5
Scope of delivery . . . . .	8
Sensor	
Installation. . . . .	14
Show historical traces . . . . .	33
Single measurement . . . . .	32
Sludge settling curve . . . . .	36
Smoothing . . . . .	45
Spare parts . . . . .	69
Spectrometer. . . . .	54
Start measurement . . . . .	26
Stepper . . . . .	55
Storage . . . . .	9
Symbols . . . . .	5
<b>T</b>	
Take sample spectra . . . . .	41
Target/actual adjustment . . . . .	39
Technical Data . . . . .	70
Test sensor . . . . .	57
Trace pollution . . . . .	37
Transport . . . . .	9
Troubleshooting . . . . .	67
<b>U</b>	
Upright post . . . . .	11
Use. . . . .	4
<b>W</b>	
Wall bracket	
Installation. . . . .	13
Warnings . . . . .	67
Wiring . . . . .	16



## Declaration of Hazardous Material and De-Contamination *Erklärung zur Kontamination und Reinigung*

**RA No.**

Please reference the Return Authorization Number (RA#), obtained from Endress+Hauser, on all paperwork and mark the RA clearly on the outside of the box. If this procedure is not followed, it may result in the refusal of the package at our facility.  
*Bitte geben Sie die von E+H mitgeteilte Rücklieferungsnummer (RA#) auf allen Lieferpapieren an und vermerken Sie diese auch außen auf der Verpackung. Nichtbeachtung dieser Anweisung führt zur Ablehnung ihrer Lieferung.*

Because of legal regulations and for the safety of our employees and operating equipment, we need the "Declaration of Hazardous Material and De-Contamination", with your signature, before your order can be handled. Please make absolutely sure to attach it to the outside of the packaging.

*Aufgrund der gesetzlichen Vorschriften und zum Schutz unserer Mitarbeiter und Betriebseinrichtungen, benötigen wir die unterschriebene "Erklärung zur Kontamination und Reinigung", bevor Ihr Auftrag bearbeitet werden kann. Bringen Sie diese unbedingt außen an der Verpackung an.*

**Type of instrument / sensor**  
*Geräte-/Sensortyp* \_\_\_\_\_

**Serial number**  
*Seriennummer* \_\_\_\_\_

**Used as SIL device in a Safety Instrumented System / Einsatz als SIL Gerät in Schutzeinrichtungen**

**Process data/ Prozessdaten**  
 Temperature / *Temperatur* \_\_\_\_\_ [°F] \_\_\_\_\_ [°C]      Pressure / *Druck* \_\_\_\_\_ [psi] \_\_\_\_\_ [ Pa ]  
 Conductivity / *Leitfähigkeit* \_\_\_\_\_ [µS/cm]      Viscosity / *Viskosität* \_\_\_\_\_ [cp] \_\_\_\_\_ [mm<sup>2</sup>/s]

**Medium and warnings**  
*Warnhinweise zum Medium*



	Medium / concentration <i>Medium / Konzentration</i>	Identification CAS No.	flammable <i>entzündlich</i>	toxic <i>giftig</i>	corrosive <i>ätzend</i>	harmful/ irritant <i>gesundheitsschädlich/ reizend</i>	other * <i>sonstiges*</i>	harmless <i>unbedenklich</i>
Process medium <i>Medium im Prozess</i>								
Medium for process cleaning <i>Medium zur Prozessreinigung</i>								
Returned part cleaned with <i>Medium zur Endreinigung</i>								

\* explosive; oxidising; dangerous for the environment; biological risk; radioactive  
\* *explosiv; brandfördernd; umweltgefährlich; biogefährlich; radioaktiv*

Please tick should one of the above be applicable, include safety data sheet and, if necessary, special handling instructions.  
*Zutreffendes ankreuzen; trifft einer der Warnhinweise zu, Sicherheitsdatenblatt und ggf. spezielle Handhabungsvorschriften beilegen.*

**Description of failure / Fehlerbeschreibung** \_\_\_\_\_  
 \_\_\_\_\_  
 \_\_\_\_\_

**Company data / Angaben zum Absender**

Company / <i>Firma</i> _____	Phone number of contact person / <i>Telefon-Nr. Ansprechpartner:</i> _____
Address / <i>Adresse</i> _____	Fax / E-Mail _____
_____	Your order No. / <i>Ihre Auftragsnr.</i> _____

"We hereby certify that this declaration is filled out truthfully and completely to the best of our knowledge. We further certify that the returned parts have been carefully cleaned. To the best of our knowledge they are free of any residues in dangerous quantities."

*"Wir bestätigen, die vorliegende Erklärung nach unserem besten Wissen wahrheitsgetreu und vollständig ausgefüllt zu haben. Wir bestätigen weiter, dass die zurückgesandten Teile sorgfältig gereinigt wurden und nach unserem besten Wissen frei von Rückständen in gefährbringender Menge sind."*

[www.endress.com/worldwide](http://www.endress.com/worldwide)

---

**Endress+Hauser**   
People for Process Automation

