



Level



Pressure



Flow



Temperature



Liquid  
Analysis



Registration



Systems  
Components



Services



Solutions

## Brief Operating Instructions

# Cerabar M

## PMC51, PMP51, PMP55

### Process pressure measurement

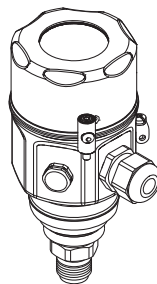
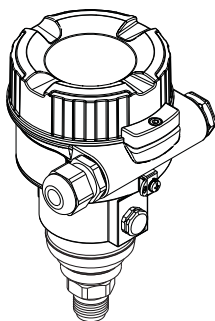

These Instructions are Brief Operating Instructions; they are not a substitute for the Operating Instructions pertaining to the device.

Detailed information about the device can be found in the Operating Instructions and the other documentation:

Available for all device versions via:

- Internet: [www.endress.com/deviceviewer](http://www.endress.com/deviceviewer)
- Smart phone/tablet: *Endress+Hauser Operations App*

KA01032P/00/EN/04.14  
71269380

Endress+Hauser

People for Process Automation

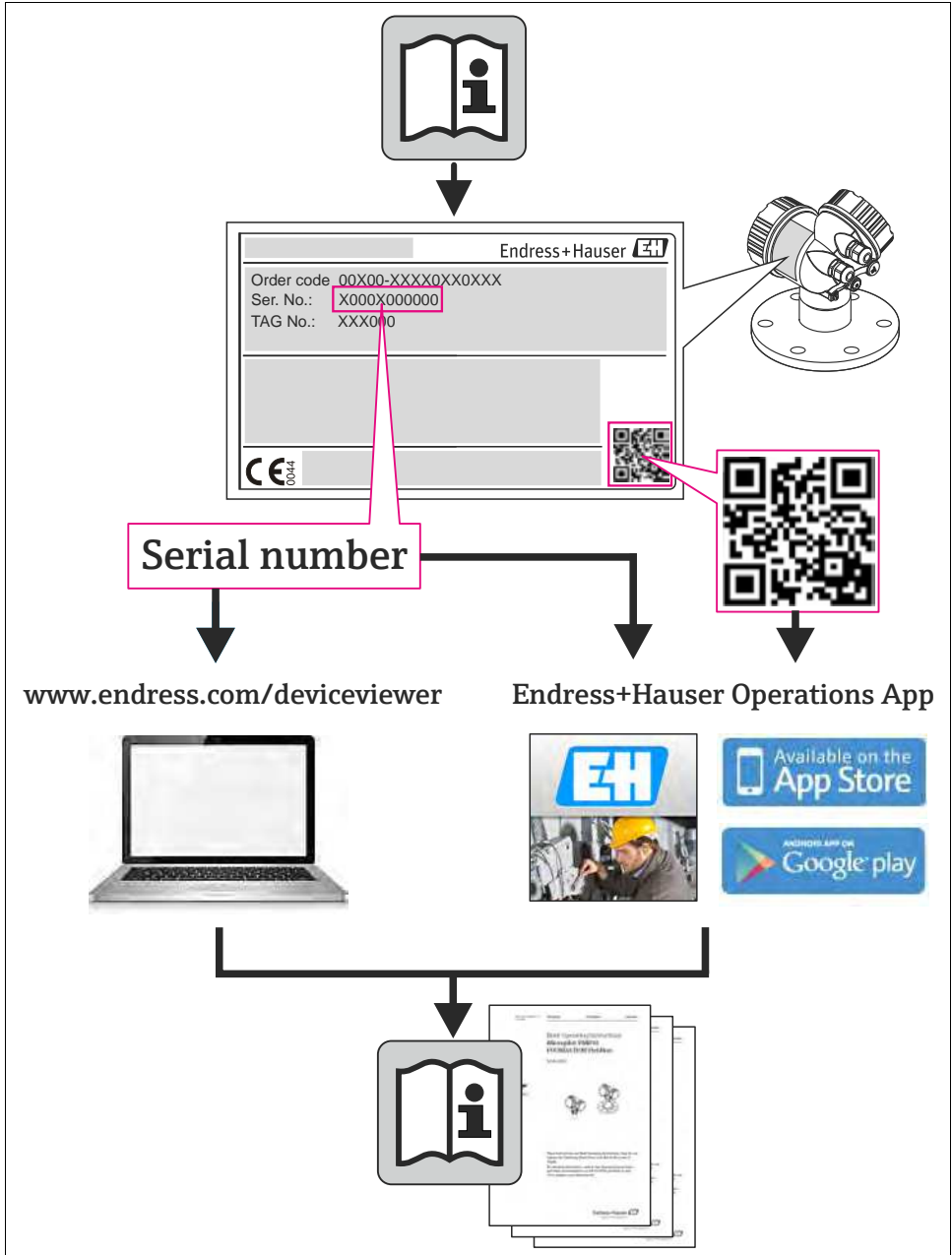

A0023555

# Table of contents

<b>1</b>	<b>Safety instructions</b>	<b>4</b>
1.1	Designated use	4
1.2	Installation, commissioning and operation	4
1.3	Operational safety and process safety	4
1.4	Return	5
1.5	Safety icons	5
<b>2</b>	<b>Identification</b>	<b>5</b>
2.1	Product identification	5
<b>3</b>	<b>Mounting</b>	<b>5</b>
3.1	Installation position	6
3.2	Installation instructions for devices without diaphragm seals – PMP51, PMC51	6
3.3	Installation instructions for devices with diaphragm seals – PMP55	7
3.4	Assembling and mounting the "separate housing" version	9
3.5	Closing the housing cover	10
3.6	Post-installation check	10
<b>4</b>	<b>Wiring</b>	<b>11</b>
4.1	Connecting the device	11
4.2	Connecting the measuring unit	12
4.3	Potential equalization	13
4.4	Post-connection check	14
<b>5</b>	<b>Operation</b>	<b>14</b>
5.1	Operation without an operating menu	14
5.2	Operation with an operating menu	16
<b>6</b>	<b>Commissioning without an operating menu</b>	<b>25</b>
6.1	Function check	25
6.2	Position adjustment	25
<b>7</b>	<b>Commissioning with an operating menu (onsite display/FieldCare)</b>	<b>26</b>
7.1	Function check	26
7.2	Commissioning	26
7.3	Pos. zero adjust	28
7.4	Level measurement	29
7.5	Linearization	39
7.6	Pressure measurement	44
<b>8</b>	<b>Commissioning with the FF configuration program</b>	<b>45</b>
8.1	Function check	45
8.2	Commissioning	45
8.3	Scaling the OUT parameter	48

# 1 Safety instructions

## 1.1 Designated use

The Cerabar M is a pressure transmitter for measuring level and pressure.

The manufacturer accepts no liability for damages resulting from incorrect use or use other than that designated.

## 1.2 Installation, commissioning and operation

- The device must only be installed, connected, commissioned and maintained by qualified and authorized specialists (e.g. electrical technicians) in full compliance with the instructions in this manual, the applicable norms, legal regulations and certificates (depending on the application).
- The specialist must have read and understood this manual and must follow the instructions it contains. If you are unclear on anything in these Brief Operating Instructions, you must read the Operating Instructions. The Operating Instructions provide detailed information on the device/measuring system.
- The device may only be modified or repaired if such work is expressly permitted in the Operating Instructions.
- If faults cannot be rectified, the device must be taken out of service and secured against unintentional commissioning.
- Do not operate damaged devices. Mark them as defective.

## 1.3 Operational safety and process safety

- Alternative monitoring measures must be taken to ensure operational safety and process safety during configuration, testing and maintenance work on the device.
- The device is safely built and tested according to state-of-the-art technology and has left the factory in perfect condition as regards technical safety. The applicable regulations and European standards have been taken into account.
- Pay particular attention to the technical data on the nameplate.
- Devices for use in hazardous areas are fitted with an additional nameplate. If the device is to be installed in an explosion hazardous area, then the specifications in the certificate as well as all national and local regulations must be observed. The device is accompanied by separate "Ex documentation", which is an integral part of this Operating Instructions. The installation regulations, connection values and Safety Instructions listed in this Ex document must be observed. The documentation number of the related Safety Instructions is also indicated on the additional nameplate.





Warning!

Only disassemble the device in pressurless condition!

## 1.4 Return

Follow the instructions on returning the device as outlined in the Operating Instructions.

## 1.5 Safety icons

Symbol	Meaning
	<b>Warning!</b> A warning highlights actions or procedures which, if not performed correctly, will lead to personal injury, a safety hazard or destruction of the instrument.
	<b>Caution!</b> Caution highlights actions or procedures which, if not performed correctly, may lead to personal injury or incorrect functioning of the instrument.
	<b>Note!</b> A note highlights actions or procedures which, if not performed correctly, may indirectly affect operation or may lead to an instrument response which is not planned.

# 2 Identification

## 2.1 Product identification

The following options are available for identification of the measuring device:

- Nameplate specifications
- Order code with breakdown of the device features on the delivery note
- Enter serial numbers from nameplates in W@M Device Viewer ([www.endress.com/deviceviewer](http://www.endress.com/deviceviewer)): All information about the measuring device is displayed.

For an overview of the technical documentation provided, enter the serial number from the nameplates in the W@M Device Viewer ([www.endress.com/deviceviewer](http://www.endress.com/deviceviewer)).

## 3 Mounting



**Warning!**

The seal is not allowed to press against the process isolating diaphragm as this could affect the measurement result.

### 3.1 Installation position



Note!

- Due to the orientation of the Cerabar M, there may be a shift in the measured value, i.e. when the container is empty, the measured value does not display zero. You may correct this zero point shift by a position adjustment in one of the following ways:
  - via the operation keys on the electronics module (→ § 15, "Function of the operating elements")
  - via the operating menu (→ § 28, "Pos. zero adjust")
- For PMP55, please refer to Section 3.3 "Installation instructions for devices with diaphragm seals – PMP55", → § 7.
- Endress+Hauser offers a mounting bracket for installing on pipes or walls (see Operating Instructions BA00384P).

### 3.2 Installation instructions for devices without diaphragm seals – PMP51, PMC51



Note!

- If a heated Cerabar M is cooled during the cleaning process (e.g. by cold water), a vacuum develops for a short time, whereby moisture can penetrate the sensor through the pressure compensation (1). If this is the case, mount the Cerabar M with the pressure compensation (1) pointing downwards.

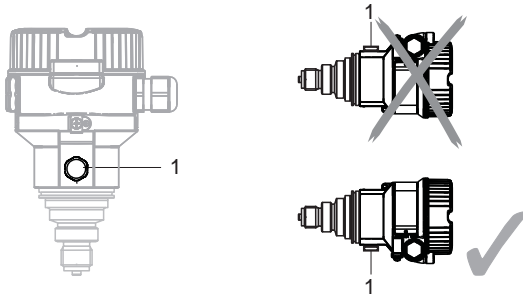

- Keep the pressure compensation and GORE-TEX® filter (1) free from contamination.
- Cerabar M transmitters without diaphragm seals are mounted as per the norms for a manometer (DIN EN 837-2). We recommend the use of shutoff devices and siphons. The orientation depends on the measuring application.
- Do not clean or touch process isolating diaphragms with hard or pointed objects.

#### 3.2.1 Pressure measurement in gases

- Mount Cerabar M with shutoff device above the tapping point so that condensate which may be present, can flow into the process.

#### 3.2.2 Pressure measurement in steams

- Mount Cerabar M with siphon above the tapping point.

- Fill the siphon with liquid before commissioning.  
The siphon reduces the temperature to almost the ambient temperature.

### 3.2.3 Pressure measurement in liquids

- Mount Cerabar M with shutoff device below or at the same level as the tapping point.

### 3.2.4 Level measurement

- Always install the Cerabar M below the lowest measuring point.
- Do not mount the device in the filling curtain or at a point in the tank which could be affected by pressure pulses from an agitator.
- Do not mount the device in the suction area of a pump.
- The calibration and functional test can be carried out more easily if you mount the device downstream of a shutoff device.

## 3.3 Installation instructions for devices with diaphragm seals – PMP55



### Note!

- Cerabar M devices with diaphragm seals are screwed in, flanged or clamped, depending on the type of diaphragm seal.
- A diaphragm seal and the pressure transmitter together form a closed, oil-filled calibrated system. The fill fluid hole is sealed and may not be opened.
- Do not clean or touch the process isolating diaphragm of the diaphragm seal with hard or pointed objects.
- Do not remove process isolating diaphragm protection until shortly before installation.
- When using a mounting bracket, sufficient strain relief must be ensured for the capillaries in order to prevent the capillary bending down (bending radius  $\geq 100$  mm (3.94 in)).
- Please note that the hydrostatic pressure of the liquid columns in the capillaries can cause zero point shift. The zero point shift can be corrected. → 28, Section 7.3 "Pos. zero adjust".
- Please observe the application limits of the diaphragm seal filling oil as detailed in the Technical Information for Cerabar M TI00436P, "Planning instructions for diaphragm seal systems" section.

In order to obtain more precise measurement results and to avoid a defect in the device, mount the capillaries as follows:

- Vibration-free (in order to avoid additional pressure fluctuations)
- Not in the vicinity of heating or cooling lines
- Insulate if the ambient temperature is below or above the reference temperature
- With a bending radius of  $\geq 100$  mm (3.94 in).

### 3.3.1 Vacuum application

For applications under vacuum, Endress+Hauser recommends mounting the pressure transmitter below the diaphragm seal. This prevents vacuum loading of the diaphragm seal caused by the presence of filling oil in the capillaries.

When the pressure transmitter is mounted above the diaphragm seal, the maximum height difference  $H_1$  in accordance with the illustration below left must not be exceeded. The maximum height difference depends on the density of the filling oil and the smallest ever pressure that is permitted to occur at the diaphragm seal (empty container), see illustration below right.

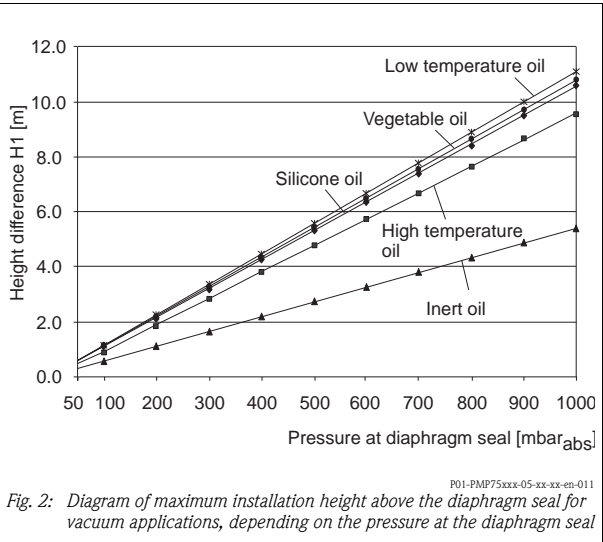
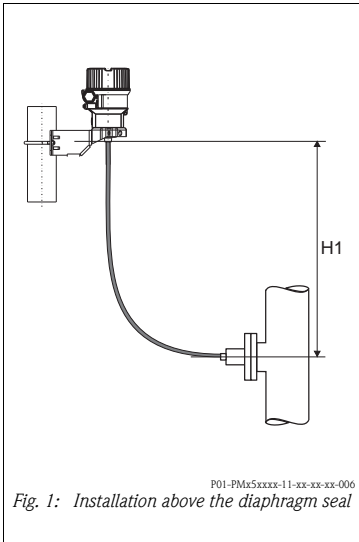



### 3.4 Assembling and mounting the "separate housing" version

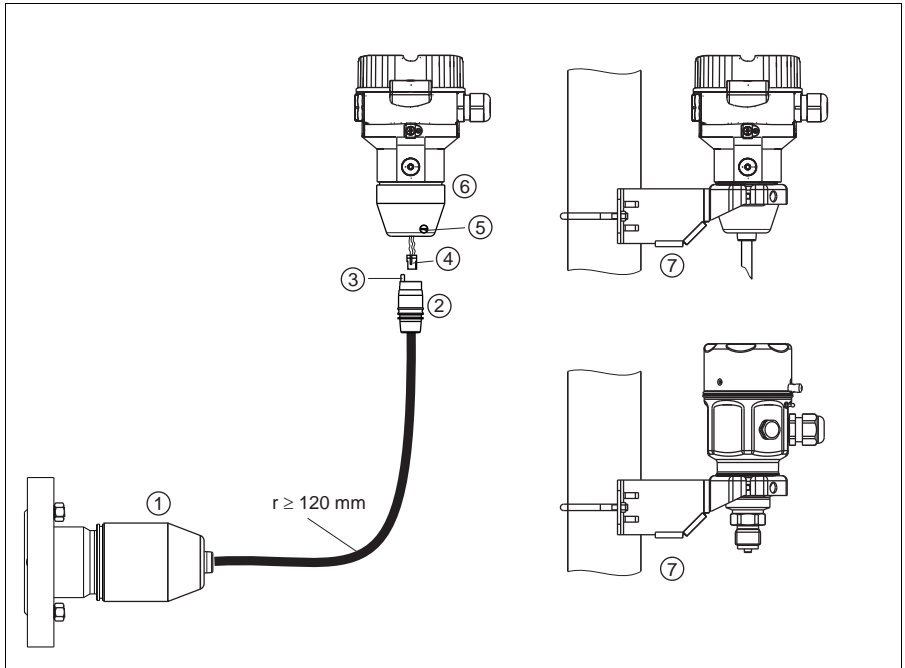

P01-3Mx5xxxx-11-xx-xx-xx-009

Fig. 3: "Separate housing" version

- 1 In the case of the "separate housing" version, the sensor is delivered with the process connection and cable ready mounted.
- 2 Cable with connection jack
- 3 Pressure compensation
- 4 Connector
- 5 Locking screw
- 6 Housing mounted with housing adapter, included
- 7 Mounting bracket provided, suitable for pipe and wall mounting (for pipes from 1 1/4" up to 2" diameter)

#### 3.4.1 Assembly and mounting

1. Insert the connector (item 4) into the corresponding connection jack of the cable (item 2).
2. Plug the cable into the housing adapter (item 6).
3. Tighten the locking screw (item 5).
4. Mount the housing on a wall or pipe using the mounting bracket (item 7).  
When mounting on a pipe, tighten the nuts on the bracket uniformly with a torque of at least 5 Nm (3.69 lbf ft).  
Mount the cable with a bending radius ( $r$ )  $\geq$  120 mm (4.72 in).

## 3.5 Closing the housing cover



### Note!

When closing the housing cover, please ensure that the thread of the cover and housing are free from dirt, e.g. sand. If you feel any resistance when closing the cover, check the thread on both again to ensure that they are free from dirt.

### 3.5.1 Closing the cover on the stainless steel housing

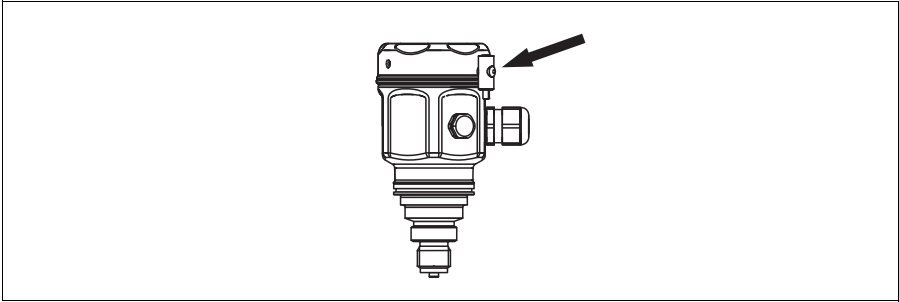

P01-PMx5xxxx-17-xxx-xx-xx-001

Fig. 4: Closing the cover

The cover for the electronics compartment is tightened by hand at the housing until the stop. The screw serves as DustEx protection (only available for devices with DustEx approval).

## 3.6 Post-installation check

After installing the device, carry out the following checks:

- Are all screws firmly tightened?
- Are the housing covers screwed down tight?

## 4 Wiring

### 4.1 Connecting the device



Note!

- When using the measuring device in hazardous areas, installation must comply with the corresponding national standards and regulations and the Safety Instructions or Installation or Control Drawings.
- A suitable circuit breaker has to be provided for the device in accordance with IEC/EN 61010.
- Devices with integrated overvoltage protection must be earthed.
- Protective circuits against reverse polarity, HF influences and overvoltage peaks are integrated.

#### The procedure

1. Check if the supply voltage matches the specified supply voltage on the nameplate.
2. Switch off the supply voltage before connecting the device.
3. Remove housing cover.
4. Guide cable through the gland. Preferably use twisted, screened two-wire cable.
5. Connect device in accordance with the following diagram.
6. Screw down housing cover.
7. Switch on supply voltage.

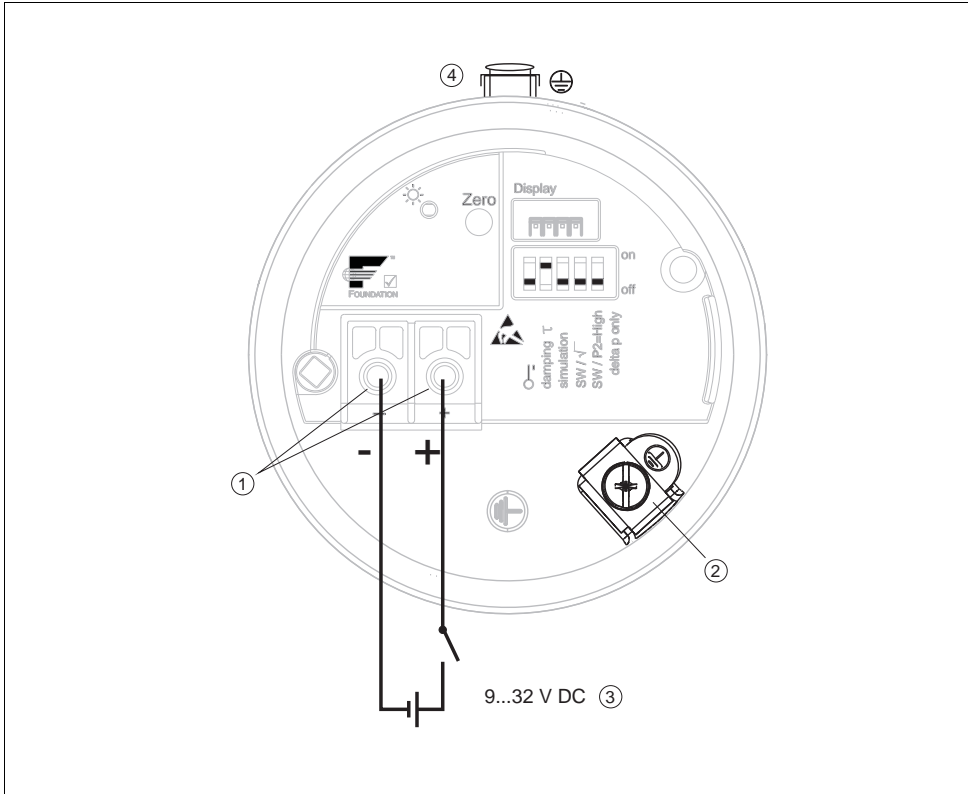

FOUNDATION Fieldbus electrical connection

F01-xMx5xxxx-04-xx-xx-xx-014

- 1 Terminals for supply voltage and signal
- 2 Grounding terminal
- 3 Supply voltage: 9 to 32 VDC (Power conditioner)
- 4 External ground terminal

## 4.2 Connecting the measuring unit

### 4.2.1 Supply voltage



Note!

- When using the measuring device in hazardous areas, installation must comply with the corresponding national standards and regulations and the Safety Instructions or Installation or Control Drawings.

- All explosion protection data are given in separate documentation which is available upon request. The Ex documentation is supplied as standard with all devices approved for use in explosion hazardous areas.
- For further information on the network structure and grounding and for further bus system components such as bus cables, see the relevant documentation, e.g. Operating Instructions BA00013S "FOUNDATION Fieldbus Overview" and the FOUNDATION Fieldbus Guideline.

<b>Electronic version</b>	
FOUNDATION Fieldbus, version for non-hazardous areas	9 to 32 V DC

#### 4.2.2 Current consumption

16 mA  $\pm$  1 mA, switch-on current corresponds to IEC 61158-2, Clause 21.

#### 4.2.3 Cable specification

- Endress+Hauser recommends using twisted, shielded two-wire cables.
- Terminals for wire cross-sections 0.5 to 2.5 mm<sup>2</sup> (20 to 14 AWG)
- Cable outer diameter: 5 to 9 mm (0.2 to 0.35 in) depends on the used cable gland (see technical information)



Note!

For further information on the cable specifications, see Operating Instructions BA00013S "FOUNDATION Fieldbus Overview", FOUNDATION Fieldbus Guideline and IEC 61158-2 (MBP).

#### 4.2.4 Shielding/potential equalization

- You achieve optimum shielding against disturbances if the shielding is connected on both sides (in the cabinet and on the device). If potential equalization currents are expected in the plant, only ground shielding on one side, preferably at the transmitter.
- When using in hazardous areas, you must observe the applicable regulations. Separate Ex documentation with additional technical data and instructions is included with all Ex systems as standard.

### 4.3 Potential equalization

Hazardous area applications: Connect all devices to the local potential equalization. Observe the applicable regulations.

## 4.4 Post-connection check

Perform the following checks after completing electrical installation of the device:

- Does the supply voltage match the specifications on the nameplate?
- Is the device connected as per Section 3.1?
- Are all screws firmly tightened?
- Are the housing covers screwed down tight?

As soon as voltage is applied to the device, the green LED on the electronic insert lights up briefly or the connected onsite display lights up.

# 5 Operation

## 5.1 Operation without an operating menu

### 5.1.1 Position of operating elements

The operating key and DIP switches are located on the electronic insert in the device.

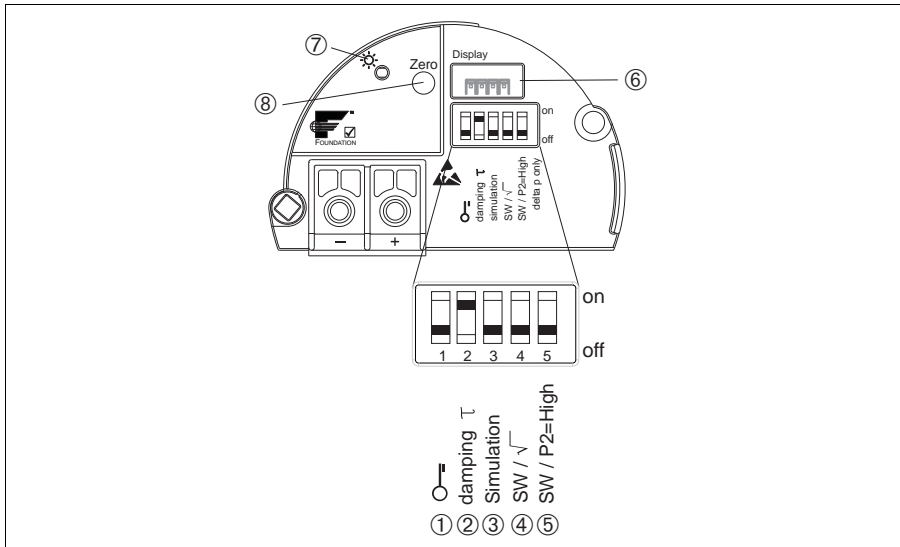

P01-Mxxxxxxx-19-xx-xx-xx-001

Fig. 5: FOUNDATION Fieldbus electronic insert

- 1 DIP switch for locking/unlocking parameters relevant to the measured value
- 2 DIP switch for switching damping on/off
- 3 DIP switch for simulation
- 4/5 DIP switch only for Deltabar M

- 6 Slot for optional onsite display  
 7 Green LED to indicate successful operation (position adjustment, reset, PowerUp-Reset)  
 8 Operating key for position adjustment or reset (zero)

## Function of the DIP switches

Switches	Symbol/ labeling	Switch position	
		"off"	"on"
1		The device is unlocked. Parameters relevant to the measured value can be modified.	The device is locked. Parameters relevant to the measured value cannot be modified.
2	damping $\tau$	Damping is switched off. The output signal follows measured value changes without any delay.	Damping is switched on. The output signal follows measured value changes with the delay time $\tau$ . <sup>1)</sup>
3	Simulation	The simulation mode is switched off (factory setting).	The simulation mode is switched on.

- 1) The value for the delay time can be configured via the operating menu ("Setup" -> "Damping").  
 Factory setting:  $\tau = 2$  s or as per order specifications.

## Function of the operating elements

Operating key	Meaning
"Zero" pressed for at least 3 seconds	<b>Position adjustment (zero point correction)</b> Press key for at least 3 seconds. The LED on the electronic insert lights up briefly if the pressure applied has been accepted for position adjustment. → See also the following Section "Performing position adjustment on site."
"Zero" pressed for at least 12 seconds	<b>Reset</b> All parameters are reset to the order configuration.

## Performing position adjustment on site



Note!

- Operation must be unlocked. →  24, Section 5.2.4 "Locking/unlocking operation".
- The device is configured for the Pressure measuring mode as standard.
  - Operation via FF configuration program: In the Pressure Transducer Block, you can change the measuring mode by means of the PRIMARY\_VALUE\_TYPE parameter.
- The pressure applied must be within the nominal pressure limits of the sensor. See information on the nameplate.
- To reconcile the parameter database, perform a "Reconcile device" (after position adjustment) with the FF host.

Perform position adjustment:

1. Pressure is present at device.
2. Press key for at least 3 seconds.
3. If the LED on the electronic insert lights up briefly, the pressure applied has been accepted for position adjustment.  
If the LED does not light up, the pressure applied was not accepted. Observe the input limits. For error messages, see Operating Instructions.

**5.1.2 Locking/unlocking operation**

Once you have entered all the parameters, you can lock your entries against unauthorized and undesired access.



Note!

If operation is locked by means of the DIP switch, you can only unlock operation again by means of the DIP switch. If operation is locked by means of the operating menu, you can only unlock operation again using the operating menu.

**Locking/unlocking via DIP switches**

DIP switch 1 on the electronic insert is used to lock/unlock operation.

→ 15, "Function of the DIP switches".

**5.2 Operation with an operating menu**

**5.2.1 Operation concept**

The operation concept makes a distinction between the following user roles:

User role	Meaning
Operator	Operators are responsible for the devices during normal "operation". This is usually limited to reading process values either directly at the device or in a control room. If the work with the devices extends beyond value read-off tasks, the tasks involve simple, application-specific functions that are used in operation. Should an error occur, these users simply forward the information on the errors but do not intervene themselves.
Service engineer/ technician	Service engineers usually work with the devices in the phases following device commissioning. They are primarily involved in maintenance and troubleshooting activities for which simple settings have to be made at the device. Technicians work with the devices over the entire life cycle of the product. Thus, commissioning and advanced settings and configurations are some of the tasks they have to carry out.
Expert	Experts work with the devices over the entire product life cycle, but their device requirements are often extremely high. Individual parameters/functions from the overall functionality of the devices are required for this purpose time and again. In addition to technical, process-oriented tasks, experts can also perform administrative tasks (e.g. user administration). "Experts" can avail of the entire parameter set.



## 5.2.2 Structure of the operating menu

User role	Submenu	Meaning/use
Operator	Language	Only consists of the "Language" parameter (000) where the operating language for the device is specified. The language can always be changed even if the device is locked.
Operator	Display/operat.	Contains parameters that are needed to configure the measured value display (selecting the values displayed, display format, display contrast, etc.). With this submenu, users can change the measured value display without affecting the actual measurement.
Service engineer/ technician	Setup	Contains all the parameters that are needed to commission measuring operations. This submenu has the following structure: <ul style="list-style-type: none"> <li>■ <b>Standard setup parameters</b> A wide range of parameters, which can be used to configure a typical application, is available at the start. The measuring mode selected determines which parameters are available. After making settings for all these parameters, the measuring operation should be completely configured in the majority of cases.</li> <li>■ <b>"Extended setup" submenu</b> The "Extended setup" submenu contains additional parameters for more in-depth configuration of the measurement operation to convert the measured value and to scale the output signal. This menu is split into additional submenus depending on the measuring mode selected.</li> </ul>
Service engineer/ technician	Diagnosis	Contains all the parameters that are needed to detect and analyze operating errors. This submenu has the following structure: <ul style="list-style-type: none"> <li>■ <b>Diagnostic list</b> Contains up to 10 error messages currently pending.</li> <li>■ <b>Event logbook</b> Contains the last 10 error messages (no longer pending).</li> <li>■ <b>Instrument info</b> Contains information on the device identification.</li> <li>■ <b>Measured values</b> Contains all the current measured values</li> <li>■ <b>Simulation</b> Is used to simulate pressure, level and alarm/warning.</li> <li>■ <b>Reset</b></li> </ul>
Expert	Expert	Contains all the parameters of the device (including those in one of the submenus). The "Expert" submenu is structured by the function blocks of the device. It thus contains the following submenus: <ul style="list-style-type: none"> <li>■ <b>System</b> Contains general device parameters that neither affect measurement nor integration into a distributed control system.</li> <li>■ <b>Measurement</b> Contains all the parameters for configuring the measurement.</li> <li>■ <b>Communication</b> Contains all the parameters of the FOUNDATION Fieldbus interface.</li> <li>■ <b>Application</b> Contains all the parameters for configuring the functions that go beyond the actual measurement (e.g. totalizer).</li> <li>■ <b>Diagnosis</b> Contains all the parameters that are needed to detect and analyze operating errors.</li> </ul>

### 5.2.3 Operation with a device display (optional)

A 4-line liquid crystal display (LCD) is used for display and operation. The onsite display shows measured values, dialog texts, fault messages and notice messages.

For easy operation the display can be taken out of the housing (see figure steps 1 to 3). It is connected to the device through a 90 mm (3.54 in) cable.

The display of the device can be turned in 90° stages (see figure steps 4 to 6).

Depending on the orientation of the device, this makes it easy to operate the device and read the measured values.

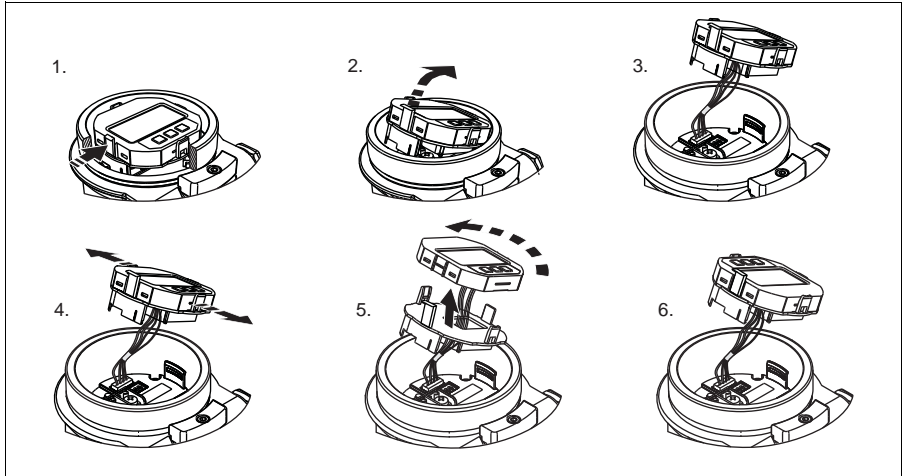

P01-Mxxxxxxx-19-xx-xx-xx-008





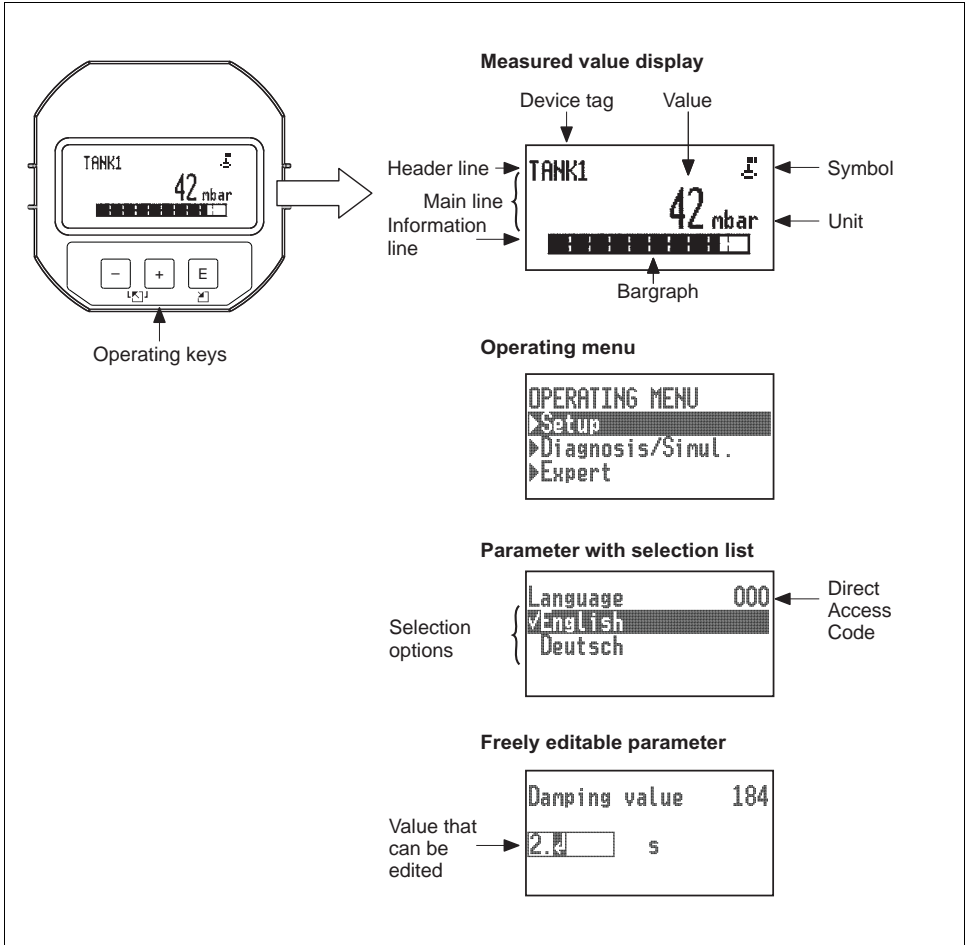

Functions:

- 8-digit measured value display including sign and decimal point.
- Bar graph as graphic display of the current pressure measured value in relation to the set pressure range in the Pressure Transducer Block. The pressure range is set by means of the SCALE\_IN parameter (via FF configuration program, not via onsite display).
- Three keys for operation.
- Simple and complete menu guidance as parameters are split into several levels and groups.
- Each parameter is given a 3-digit parameter code for easy navigation.
- Possibility of configuring the display to suit individual requirements and preferences, such as language, alternating display, display of other measured values such as sensor temperature, contrast setting.
- Comprehensive diagnostic functions (fault and warning message etc.).











P01-Mxxxxxx-07-xx-xx-xx-002

The following table illustrates the symbols that can appear on the onsite display. Four symbols can occur at one time.

Symbol	Meaning
	<b>Lock symbol</b> The operation of the device is locked. To unlock the device, → 24, Locking/unlocking operation.
	<b>Communication symbol</b> Data transfer via communication
	<b>Error message "Out of specification"</b> The device is being operated outside its technical specifications (e.g. during warmup or cleaning processes).
	<b>Error message "Service mode"</b> The device is in the service mode (during a simulation, for example).
	<b>Error message "Maintenance required"</b> Maintenance is required. The measured value remains valid.
	<b>Error message "Failure detected"</b> An operating error has occurred. The measured value is no longer valid.
	<b>Simulation symbol</b> Simulation mode is activated. DIP switch 2 for simulation is set to "On". → See also Section 5.1.1 "Position of operating elements" and in the Operating Instructions.



### Operating keys on the display and operating module

Operating key(s)	Meaning
	<ul style="list-style-type: none"> <li>– Navigate downwards in the picklist</li> <li>– Edit the numerical values and characters within a function</li> </ul>
	<ul style="list-style-type: none"> <li>– Navigate upwards in the picklist</li> <li>– Edit the numerical values and characters within a function</li> </ul>
	<ul style="list-style-type: none"> <li>– Confirm entry</li> <li>– Jump to the next item</li> <li>– Selection of a menu item and activation of the editing mode</li> </ul>
 and 	Contrast setting of onsite display: darker

Operating key(s)	Meaning
 and 	Contrast setting of onsite display: brighter
 and 	ESC functions: – Exit the edit mode for a parameter without saving the changed value. – You are in a menu at a selection level. Each time you press the keys simultaneously, you go up a level in the menu.

### Parameters with a picklist

Example: selecting "Deutsch" as the language of the menu.

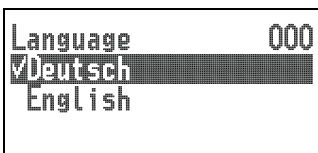
Onsite display	Operation
 <p style="text-align: right; font-size: small;">P01-PMDS5xxx-19-xx-xx-xx-002</p>	"English" is set as the menu language (default value). A ✓ in front of the menu text indicates the active option.
 <p style="text-align: right; font-size: small;">P01-PMDS5xxx-19-xx-xx-xx-001</p>	Select "Deutsch" with "+" or "-".
 <p style="text-align: right; font-size: small;">P01-PMDS5xxx-19-xx-xx-xx-000</p>	<ol style="list-style-type: none"> <li>1. Confirm your choice with "E". A ✓ in front of the menu text indicates the active option. ("Deutsch" is now selected as the menu language.)</li> <li>2. Exit the edit mode for the parameter with "E".</li> </ol>

### User-definable parameters

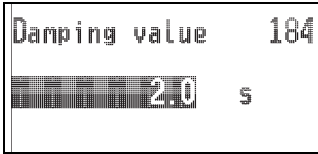
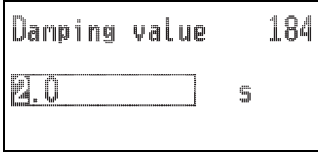
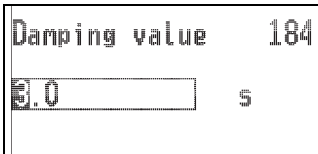
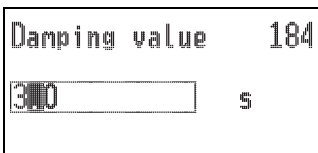
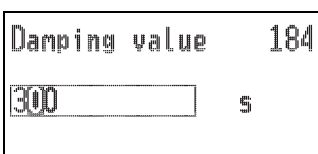
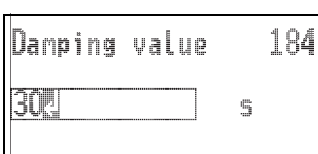

Example: changing the DAMPING VALUE function from 2.0 s to 30.0 s.

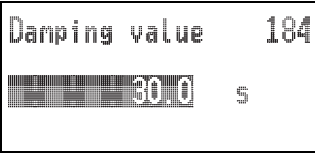
Onsite display	Operation
 <p style="text-align: center; font-size: small;">P01-xxxxxxxx-19-xx-xx-en-001</p>	<p>The local display shows the parameter to be changed. The value highlighted in black can be changed. The unit "s" is prespecified and cannot be changed.</p>
 <p style="text-align: center; font-size: small;">P01-xxxxxxxx-19-xx-xx-en-002</p>	<ol style="list-style-type: none"> <li>1. Press "+" or "-" to get to the editing mode.</li> <li>2. The first digit is highlighted in black.</li> </ol>
 <p style="text-align: center; font-size: small;">P01-xxxxxxxx-19-xx-xx-en-003</p>	<ol style="list-style-type: none"> <li>1. Use "+" to change "2" to "3".</li> <li>2. Confirm "3" with "E". The cursor jumps to the next position (highlighted in black).</li> </ol>
 <p style="text-align: center; font-size: small;">P01-xxxxxxxx-19-xx-xx-en-004</p>	<p>The decimal point is highlighted in black. This means you can now edit this digit.</p>
 <p style="text-align: center; font-size: small;">P01-xxxxxxxx-19-xx-xx-en-005</p>	<ol style="list-style-type: none"> <li>1. Press "+" or "-" until "0" is displayed.</li> <li>2. Confirm "0" with "E". The cursor goes to the next position. <math>\downarrow</math> is displayed and highlighted in black. → See next graphic.</li> </ol>
 <p style="text-align: center; font-size: small;">P01-xxxxxxxx-19-xx-xx-en-006</p>	<p>Use "E" to save the new value and exit the editing mode. → See next graphic.</p>

Onsite display	Operation
 <p style="text-align: center; font-size: small;">P01-xxxxxxx-19-xx-xx-en-007</p>	<p>The new value for the damping is 30.0 s.</p> <ul style="list-style-type: none"> <li>- Go to the next parameter with "E" .</li> <li>- You can get back to the editing mode with "+" or "-".</li> </ul>

### Accepting the pressure present

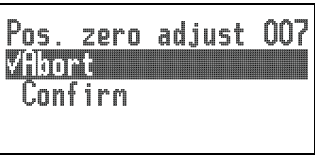
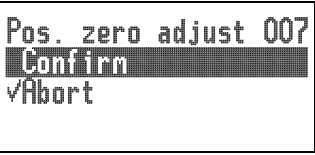
Example: setting position adjustment

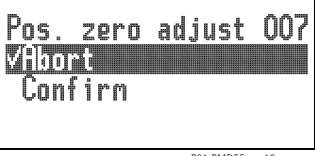
Onsite display	Operation
 <p style="text-align: center; font-size: small;">P01-PMD55xxx-19-xx-xx-009</p>	<p>The pressure for position adjustment is present at the device.</p>
 <p style="text-align: center; font-size: small;">P01-PMD55xxx-19-xx-xx-010</p>	<p>Use "+" or "-" to switch to the "Confirm" option. The active option is highlighted in black.</p>
 <p style="text-align: center; font-size: small;">P01-PMD55xxx-19-xx-xx-011</p>	<p>Accept the pressure present as position adjustment with the "E" key. The device confirms the adjustment and goes back to the "Pos. zero adjust" parameter.</p>
 <p style="text-align: center; font-size: small;">P01-PMD55xxx-19-xx-xx-009</p>	<p>Exit the edit mode for the parameter with "E" .</p>

### 5.2.4 Locking/unlocking operation

Once you have entered all the parameters, you can lock your entries against unauthorized and undesired access.

Locked operation is indicated as follows:

- By the  symbol on the onsite display
- The parameters are grayed out in FieldCare and the handheld terminal, which means they cannot be edited. Indicated in the corresponding "Lockstate/STATUS\_LOCKING" parameter.

Parameters which refer to how the display appears, e.g. "Language (000)", can still be altered.



Note!

If operation is locked by means of the DIP switch, you can only unlock operation again by means of the DIP switch. If operation is locked by means of the operating menu, you can only unlock operation again using the operating menu.

The "Operator code (021)" parameter is used to lock and unlock the device.

Parameter name	Description
<b>Operator code (021)</b> Entry  Menu path: Setup → Extended setup → Operator code (021)	Use this function to enter a code to lock or unlock operation.  <b>User input:</b> <ul style="list-style-type: none"> <li>■ To lock: Enter a number ≠ the release code (value range: 1 to 9999).</li> <li>■ To unlock: Enter the release code.</li> </ul>  Note! The release code is "0" in the order configuration. Another release code can be defined in the "Code definition (023)" parameter. If the user has forgotten the release code, the release code can be visible by entering the number "5864".  <b>Factory setting:</b> 0

The release code is defined in the "Code definition (023)" parameter.

Parameter name	Description
<b>Code definition (023)</b> Entry  Menu path: Setup → Extended setup → Code definition (023)	Use this function to enter a release code with which the device can be unlocked.  <b>User input:</b> <ul style="list-style-type: none"> <li>■ A number between 0 and 9999</li> </ul> <b>Factory setting:</b> 0



## 6 Commissioning without an operating menu



Warning!

- If a pressure smaller than the minimum permitted pressure or greater than the maximum permitted pressure is present at the device, the following messages are output in succession:
  1. "S140 Working range P" or "F140 Working range P" <sup>1)</sup>
  2. "S841 Sensor range" or "F841 Sensor range" <sup>1)</sup>



Note!

The device is configured for the Pressure measuring mode as standard. The measuring range and the unit in which the measured value is transmitted correspond to the specifications on the nameplate.

### 6.1 Function check

Carry out a post-installation and a post-connection check as per the checklist before commissioning the device.

- "Post-installation check" checklist → 10
- "Post-connection check" checklist → 14

### 6.2 Position adjustment

The following functions are possible by means of the key on the electronic insert:

- Position adjustment (zero point correction)
- Device reset (see Operating Instructions)



Note!

- Operation must be unlocked. → 24, "Locking/unlocking operation"
- The device is configured for the "Pressure" measuring mode as standard.
- The pressure applied must be within the nominal pressure limits of the sensor. See information on the nameplate.

<b>Carrying out position adjustment<sup>1)</sup></b>	
Pressure is present at device.	
↓	
Press the "Zero" key for at least 3 s.	
↓	
Does the LED on the electronic insert light up briefly?	
Yes	No

1) depending on the setting in the "Alarm behav. P" (050) parameter

Carrying out position adjustment <sup>1)</sup>	
↓	↓
Applied pressure for position adjustment has been accepted.	Applied pressure for position adjustment has not been accepted. Observe the input limits.

- 1) Observe warning on commissioning

## 7 Commissioning with an operating menu (onsite display/FieldCare)



### Warning!

- If a pressure smaller than the minimum permitted pressure or greater than the maximum permitted pressure is present at the device, the following messages are output in succession:
  1. "S140 Working range P" or "F140 Working range P" <sup>2)</sup>
  2. "S841 Sensor range" or "F841 Sensor range" <sup>2)</sup>



### Note!

The device is configured for the Pressure measuring mode as standard. The measuring range and the unit in which the measured value is transmitted correspond to the specifications on the nameplate.

### 7.1 Function check

Carry out a post-installation and a post-connection check as per the checklist before commissioning the device.

- "Post-installation check" checklist → 10
- "Post-connection check" checklist → 14

### 7.2 Commissioning

Commissioning comprises the following steps:

1. Function check (→ 26)
2. Selecting the language, measuring mode and pressure unit (→ 26)
3. Position adjustment (→ 28)
4. Configuring measurement:
  - Pressure measurement (→ 44 ff)
  - Level measurement (→ 29 ff)
  - Linearization (→ 39 ff)

---

2) depending on the setting in the "Alarm behav. P" (050) parameter

## 7.2.1 Selecting the language, measuring mode and pressure unit

### Language selection

Parameter name	Description
<b>Language (000)</b> Options  Menu path: Main menu → Language	Select the menu language for the onsite display.  <b>Options:</b> <ul style="list-style-type: none"> <li>■ English</li> <li>■ Possibly another language (as selected when ordering the device)</li> <li>■ One further language (language of the manufacturing plant)</li> </ul> <b>Factory setting:</b> English

### Measuring mode selection

Parameter name	Description
<b>Measuring mode (005)</b> Options  Menu path: Setup → Measuring mode	Select the measuring mode. The operating menu is structured differently depending on the measuring mode selected.   Note! If the measuring mode is changed, no conversion takes place. If necessary, the device has to be recalibrated after the measuring mode has been changed.  <b>Options:</b> <ul style="list-style-type: none"> <li>■ Pressure</li> <li>■ Level</li> </ul> <b>Factory setting:</b> Pressure

### Pressure unit selection

Parameter name	Description
<b>Press. eng. unit (125)</b> Options  Menu path: Setup → Press. eng. unit	Select the pressure unit. If a new pressure unit is selected, all pressure-specific parameters are converted and displayed with the new unit.  <b>Options:</b> <ul style="list-style-type: none"> <li>■ mbar, bar</li> <li>■ mmH<sub>2</sub>O, mH<sub>2</sub>O,</li> <li>■ inH<sub>2</sub>O, ftH<sub>2</sub>O</li> <li>■ Pa, kPa, MPa</li> <li>■ psi</li> <li>■ mmHg, inHg</li> <li>■ kgf/cm<sup>2</sup></li> </ul> <b>Factory setting:</b> mbar or bar depending on the sensor nominal measuring range, or as per order specifications

## 7.3 Pos. zero adjust

The pressure resulting from the orientation of the device can be corrected here.

Parameter name	Description
<b>Corrected press. (172)</b> Display  Menu path: Setup → Corrected press.	Displays the measured pressure after sensor trim and position adjustment.   <b>Note!</b> If this value is not equal to "0", it can be corrected to "0" by the position adjustment.
<b>Pos. zero adjust (007)</b> <b>(Deltabar M and relative pressure sensor)</b> Selection  Menu path: Setup → Pos. zero adjust	Position adjustment – the pressure difference between zero (set point) and the measured pressure need not be known.  <b>Example:</b> – Measured value = 2.2 mbar (0.032 psi) – You correct the measured value via the "Pos. zero adjust" parameter with the "Confirm" option. This means that you are assigning the value 0.0 to the pressure present. – Measured value (after pos. zero adjust) = 0.0 mbar  <b>Options</b> <ul style="list-style-type: none"> <li>■ Confirm</li> <li>■ Abort</li> </ul> <b>Factory setting:</b> Abort
<b>Calib. offset (192) / (008)</b> <b>(absolute pressure sensor)</b> Entry  Menu path: Setup → Calib. offset	Position adjustment – the pressure difference between the set point and the measured pressure must be known.  <b>Example:</b> – Measured value = 982.2 mbar (14.24 psi) – You correct the measured value with the value entered (e.g. 2.2 mbar (0.032 psi)) via the "Calib. offset" parameter. This means that you are assigning the value 980.0 (14.21 psi) to the pressure present. – Measured value (after calib. offset) = 980.0 mbar (14.21 psi)  <b>Factory setting:</b> 0.0

## 7.4 Level measurement

### 7.4.1 Information on level measurement



Note!

You have a choice of two methods for calculating the level: "In pressure" and "In height". The table in the "Overview of level measurement" section that follows provides you with an overview of these two measuring tasks.

- The limit values are not checked, i.e. the values entered must be appropriate for the sensor and the measuring task for the device to be able to measure correctly.
- Customer-specific units are not possible.
- There is no unit conversion.
- The values entered for "Empty calib. (028)/Full calib. (031)", "Empty pressure (029)/Full pressure (032)", "Empty height (030)/Full height (033)" must be at least 1 % apart. The value will be rejected, and a warning message displayed, if the values are too close together.

### 7.4.2 Overview of level measurement

Measuring task	Level selection	Measured variable options	Description	Measured value display
Calibration is performed by entering two pressure-level value pairs.	"In pressure"	Via the "Unit before lin. (025)" parameter: %, level, volume or mass units.	– Calibration with reference pressure (wet calibration), see → <a href="#">30</a> – Calibration without reference pressure (dry calibration), see → <a href="#">32</a>	The measured value display and the "Level before lin. (019)" parameter display the measured value.
Calibration is performed by entering the density and two height-level value pairs.	"In height"		– Calibration with reference pressure (wet calibration), see → <a href="#">37</a> – Calibration without reference pressure (dry calibration), see → <a href="#">34</a>	

### 7.4.3 "In pressure" level selection Calibration with reference pressure (wet calibration)

**Example:**

In this example, the level in a tank should be measured in "m". The maximum level is 3 m (9.8 ft). The pressure range is due to the filling height and the density.

**Prerequisite:**

- The measured variable is in direct proportion to the pressure.
- The tank can be filled and emptied.



**Note!**

The values entered for "Empty calib. (028)/Full calib. (031)" and the pressures present at the device must be at least 1% apart. The value will be rejected, and a warning message displayed, if the values are too close together. Further limit values are not checked; i.e. the values entered must be appropriate for the sensor and the measuring task so that the measuring device can measure correctly.

Description	
1	Perform "position adjustment" → 28.
2	Select the "Level" measuring mode via the "Measuring mode (005)" parameter.  Menu path: Setup → Measuring mode (005)
3	Select a pressure unit by means of the "Press. eng. unit (125)" parameter, here "mbar" for example.  Menu path: Setup → Press. eng. unit (125)
4	Select the "In pressure" level mode by means of the "Level selection (024)" parameter.  Menu path: Setup → Extended Setup → Level → Level selection (024)

P01-Mxxxxxxx-19-xx-xx-xx-003

*Fig. 6: Calibration with reference pressure – wet calibration*

1 See Table, Step 7.  
2 See Table, Step 8.

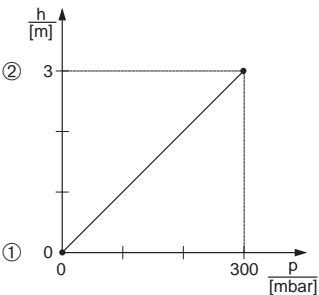
	Description	
5	Select a level unit by means of the "Unit before lin. (025)" parameter, here "m" for example.  Menu path: Setup → Extended Setup → Level → Unit before lin. (025)	
6	Select the "Wet" option by means of the "Calibration mode (027)" parameter.  Menu path: Setup → Extended Setup → Level → Calibration mode (027)	
7	The pressure for the lower calibration point is present at the device, here 0 mbar for example.	
	Select the "Empty calib. (028)" parameter.	
	Menu path: Setup → Extended Setup → Level → Empty calib. (028)  Enter the level value, here 0 m for example. The pressure value present is assigned to the lower level value by confirming the value.	
8	The pressure for the upper calibration point is present at the device, here 300 mbar (4.35 psi) for example.	P01-xxxxxxx-05-xx-xx-xx-011 Fig. 7: Calibration with reference pressure – wet calibration  1 See Table, Step 7. 2 See Table, Step 8.
	Select the "Full calib. (031)" parameter.	
	Menu path: Setup → Extended Setup → Level → Full calib. (031)  Enter the level value, here 3 m (9.8 ft) for example. The pressure value present is assigned to the upper level value by confirming the value.	
9	If calibration is performed with a medium other than the process medium, enter the density of the calibration medium in "Adjust density (034)".  Menu path: Setup → Extended Setup → Level → Adjust density (034)	
10	If calibration was performed with a medium other than the process medium, specify the density of the process medium in the "Process density (035)" parameter.  Menu path: Setup → Extended Setup → Level → Process density (035)	
11	Result: The measuring range is set for 0 to 3 m (9.8 ft).	



**Note!**

The measured variables %, level, volume and mass are available for this level mode see parameter "Unit before lin (025)" in the Operating Instructions.

### 7.4.4 "In pressure" level selection

#### Calibration without reference pressure (dry calibration)

##### Example:

In this example, the volume in a tank should be measured in liters. The maximum volume of 1000 liters (264 gal) corresponds to a pressure of 450 mbar (6.53 psi). The minimum volume of 0 liters corresponds to a pressure of 50 mbar (0.72 psi) since the device is mounted below the start of the level measuring range.

##### Prerequisite:

- The measured variable is in direct proportion to the pressure.
- This is a theoretical calibration i.e. the pressure and volume values for the lower and upper calibration point must be known.



##### Note!

- The values entered for "Empty calib. (028)/Full calib. (031)", "Empty pressure (029)/Full pressure (032)" must be at least 1% apart. The value will be rejected, and a warning message displayed, if the values are too close together. Further limit values are not checked; i.e. the values entered must be appropriate for the sensor and the measuring task so that the measuring device can measure correctly.
- Due to the orientation of the device, there may be pressure shifts in the measured value, i.e. when the container is empty or partly filled, the measured value is not zero. For information on how to perform position adjustment, see → 28, "Pos. zero adjust".

	Description	
1	Select the "Level" measuring mode via the "Measuring mode (005)" parameter.  Menu path: Setup → Measuring mode (005)	 <p style="text-align: right; font-size: small;">P01-Mxxxxxx-19-xx-xx-xx-004</p>
2	Select a pressure unit by means of the "Press. eng. unit (125)" parameter, here "mbar" for example.  Menu path: Setup → Press. eng. unit (125)	
3	Select the "In pressure" level mode by means of the "Level selection (024)" parameter.  Menu path: Setup → Extended Setup → Level → Level selection (024)	
4	Select a volume unit by means of the "Unit before lin. (025)" parameter, here "l" (liter) for example.  Menu path: Setup → Extended Setup → Level → Unit before lin. (025)	

Fig. 8: Calibration without reference pressure – dry calibration

- 1 See Table, Steps 7 and 8.
- 2 See Table, Steps 9 and 10.



	Description
5	Select the "Dry" option by means of the "Calibration mode (027)" parameter.  Menu path: Setup → Extended Setup → Level → Calibration mode (027)
6	"Adjust density (034)" contains the factory setting 1.0, but this value can be changed if required. The entered value pairs must correspond to this density.  Menu path: Setup → Extended Setup → Level → Adjust density (034)
7	Enter the volume value for the lower calibration point via the "Empty calib. (028)" parameter, here 0 liters for example.  Menu path: Setup → Extended Setup → Level → Empty calib. (028)
8	Enter the pressure value for the lower calibration point via the "Empty pressure (029)" parameter, here 50 mbar (0.72 psi) for example.  Menu path: Setup → Extended Setup → Level → Empty pressure (029)
9	Enter the volume value for the upper calibration point via the "Full calib. (031)" parameter, here 1000 liters (264 gal) for example.  Menu path: Setup → Extended Setup → Level → Full calib. (031)
10	Enter the pressure value for the upper calibration point via the "Full pressure (032)" parameter, here 450 mbar (6.53 psi) for example.  Menu path: Setup → Extended Setup → Level → Full pressure (032)
11	If calibration was performed with a medium other than the process medium, specify the density of the process medium in the "Process density (035)" parameter. Menu path: Setup → Extended Setup → Level → Process density (035)
12	Result: The measuring range is set for 0 to 1000 l (264 gal).

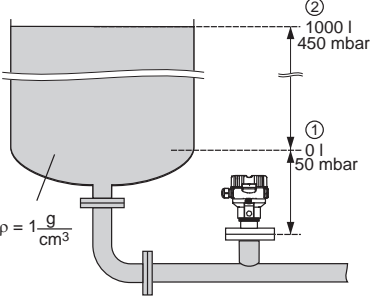
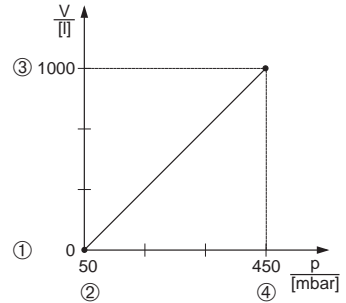

P01-xxxxxxx-05-xx-xx-xx-026

Fig. 9: Calibration with reference pressure – wet calibration

- 1 See Table, Step 7.
- 2 See Table, Step 8.
- 3 See Table, Step 9.
- 4 See Table, Step 10.



**Note!**

The measured variables %, level, volume and mass are available for this level mode see parameter "Unit before lin (025)" in the Operating Instructions.

### 7.4.5 "In height" level selection

#### Calibration without reference pressure (dry calibration)

**Example:**

In this example, the volume in a tank should be measured in liters. The maximum volume of 1000 liters (264 gal) corresponds to a level of 4.5 m (14.8 ft). The minimum volume of 0 liters corresponds to a level of 0.5 m (1.6 ft) since the device is mounted below the start of the level measuring range.

**Prerequisite:**

- The measured variable is in direct proportion to the pressure.
- This is a theoretical calibration i.e. the height and volume values for the lower and upper calibration point must be known.

**Note!**

- The values entered for "Empty calib. (028)/Full calib. (031)", "Empty height (030)/Full height (033)" must be at least 1 % apart. The value will be rejected, and a warning message displayed, if the values are too close together. Further limit values are not checked; i.e. the values entered must be appropriate for the sensor and the measuring task so that the measuring device can measure correctly.
- Due to the orientation of the device, there may be pressure shifts in the measured value, i.e. when the container is empty or partly filled, the measured value is not zero. For information on how to perform position adjustment, see → 28, "Pos. zero adjust".

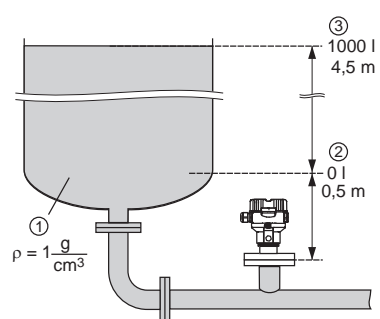
	Description	
1	Select the "Level" measuring mode via the "Measuring mode (005)" parameter.  Menu path: Setup → Measuring mode (005)	
2	Select a pressure unit via the "Press. eng. unit (125)" parameter, here "mbar" for example.  Menu path: Setup → Press. eng. unit (125)	
3	Select the "In height" level mode via the "Level selection (024)" parameter. Menu path: Setup → Extended Setup → Level → Level selection (024)	
4	Select a volume unit via the "Unit before lin. (025)" parameter, here "l" (liter) for example.  Menu path: Setup → Extended Setup → Level → Unit before lin. (025)	 <p style="text-align: right; font-size: small;">P01-MaxXXXXX-19-xx-xx-xx-007</p>
5	Select a level unit by means of the "Height unit (026)" parameter, here "m" for example.  Menu path: Setup → Extended Setup → Level → Height unit (026)	<p><i>Fig. 10: Calibration without reference pressure – dry calibration</i></p>
6	Select the "Dry" option by means of the "Calibration mode (027)" parameter.  Menu path: Setup → Extended Setup → Level → Calibration mode (027)	<p>1 See Table, Step 7. 2 See Table, Steps 8 and 9. 3 See Table, Steps 10 and 11.</p>
7	Enter the density of the medium via the "Adjust density (034)" parameter, here "1 g/cm <sup>3</sup> " (1 SGU) for example.  Menu path: Setup → Extended Setup → Level → Adjust density (034)	

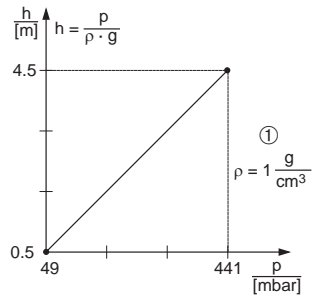
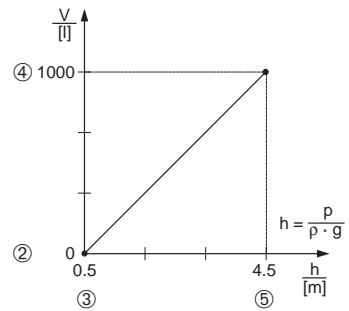
	Description	
8	Enter the volume value for the lower calibration point via the "Empty calib. (028)" parameter, here 0 liters for example.  Menu path: Setup → Extended Setup → Level → Empty calib. (028)	
9	Enter the height value for the lower calibration point via the "Empty height (030)" parameter, here 0.5 m (1.6 ft) for example.  Menu path: Setup → Extended Setup → Level → Empty height (030)	
10	Enter the volume value for the upper calibration point via the "Full calib. (031)" parameter, here 1000 liters (264 gal) for example.  Menu path: Setup → Extended Setup → Level → Full calib. (031)	<p style="text-align: right;">P01-xxxxxxx-05-xx-xx-xx-029</p>
11	Enter the height value for the upper calibration point via the "Full height (033)" parameter, here 4.5 m (14.8 ft) for example.  Menu path: Setup → Extended Setup → Level → Full height (033)	
12	If the process uses a medium other than that on which the calibration was based, the new density must be specified in the "Process density (035)" parameter.  Menu path: Setup → Extended Setup → Level → Process density (035)	<p style="text-align: right;">P01-xxxxxxx-05-xx-xx-xx-032</p>
13	Result: The measuring range is set for 0 to 1000 l (264 gal).	<p><b>Fig. 11: Calibration with reference pressure – wet calibration</b></p> <ol style="list-style-type: none"> <li>1 See Table, Step 7.</li> <li>2 See Table, Step 8.</li> <li>3 See Table, Step 9.</li> <li>4 See Table, Step 10.</li> <li>5 See Table, Step 11.</li> </ol>



**Note!**

The measured variables %, level, volume and mass are available for this level mode see parameter "Unit before lin (025)" in the Operating Instructions.

### 7.4.6 "In height" level selection Calibration with reference pressure (wet calibration)

**Example:**

In this example, the volume in a tank should be measured in liters. The maximum volume of 1000 liters (264 gal) corresponds to a level of 4.5 m (14.8 ft). The minimum volume of 0 liters corresponds to a level of 0.5 m (1.6 ft) since the device is mounted below the start of the level measuring range.

The density of the medium is 1 g/cm<sup>3</sup> (1 SGU).

**Prerequisite:**

- The measured variable is in direct proportion to the pressure.
- The tank can be filled and emptied.



**Note!**

The values entered for "Empty calib. (028)/Full calib. (031)" and the pressure values present at the device must be at least 1% apart. The value will be rejected, and a warning message displayed, if the values are too close together. Further limit values are not checked; i.e. the values entered must be appropriate for the sensor and the measuring task so that the measuring device can measure correctly.

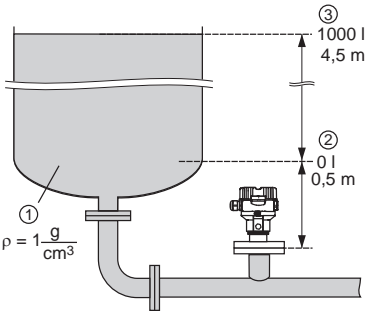
	Description	
1	Perform position adjustment. See → 28.	 <p style="text-align: right; font-size: small;">P01-Mxxxxxxx-19-xx-xx-xx-007</p> <p><i>Fig. 12: Calibration with reference pressure – wet calibration</i></p> <p>1 See Table, Step 8. 2 See Table, Step 9. 3 See Table, Step 10.</p>
2	Select the "In height" level mode via the "Level selection (024)" parameter.  Menu path: Setup → Extended Setup → Level → Level selection (024)	
3	Select the "Level" measuring mode via the "Measuring mode (005)" parameter.  Menu path: Setup → Measuring mode (005)	
4	Select a pressure unit via the "Press. eng. unit (125)" parameter, here "mbar" for example.  Menu path: Setup → Press. eng. unit (125)	
5	Select a volume unit via the "Unit before lin. (025)" parameter, here "l" (liter) for example.  Menu path: Setup → Extended Setup → Level → Unit before lin. (025)	

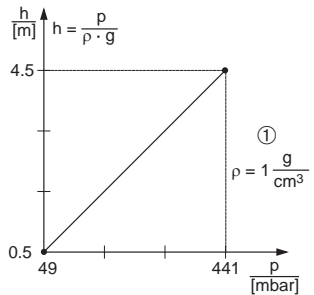
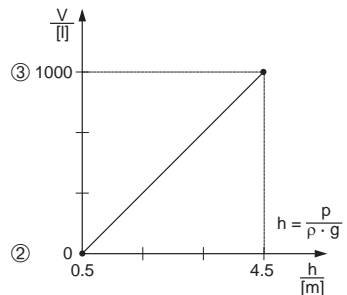
	Description	
6	Select a level unit by means of the "Height unit (026)" parameter, here "m" for example.  Menu path: Setup → Extended Setup → Level → Height unit (026)	
7	Select the "Wet" option by means of the "Calibration mode (027)" parameter. Menu path: Setup → Extended Setup → Level → Calibration mode (027)	
8	If calibration is performed with a medium other than the process medium, enter the density of the calibration medium in the "Adjust density (034)" parameter, here 1 g/cm <sup>3</sup> (1 SGU) for example. Menu path: Setup → Extended Setup → Level → Adjust density (034)	 <p style="text-align: right;">P01-xxxxxxx-05-xx-xx-xx-029</p>
9	The pressure for the lower calibration point is present at the device, here 0.5 m covered / 49 mbar (0.71 psi) for example.  Enter the volume value for the lower calibration point via the "Empty calib. (028)" parameter, here 0 liters for example. (The pressure currently measured is displayed as the height, here 0.5 m (1.6 ft) for example.)  Menu path: Setup → Extended Setup → Level → Empty calib. (028)	
10	The pressure for the upper calibration point is present at the device, here 4.5 m covered / 441 mbar (6.4 psi) for example.  Enter the volume value for the upper calibration point via the "Full calib. (031)" parameter, here "1000 liters" (264 gal) for example. The pressure currently measured is displayed as the height, here "4.5 m" (14.8 ft) for example.  Menu path: Setup → Extended Setup → Level → Full calib. (031)	 <p style="text-align: right;">P01-xxxxxxx-05-xx-xx-xx-001</p>
11	If calibration was performed with a medium other than the process medium, specify the density of the process medium in the "Process density (035)" parameter.  Menu path: Setup → Extended Setup → Level → Process density (035)	<p><i>Fig. 13: Calibration with reference pressure – wet calibration</i></p> <p>1 See Table, Step 8.                      2 See Table, Step 9.                      3 See Table, Step 10.</p>
12	Result: The measuring range is set for 0 to 1000 l (264 gal).	

 **Note!**  
 The measured variables %, level, volume and mass are available for this level mode see parameter "Unit before lin (025)" in the Operating Instructions.

## 7.5 Linearization

### 7.5.1 Manual entry of the linearization table via onsite display

**Example:**

In this example, the volume in a tank with a conical outlet should be measured in m<sup>3</sup>.

**Prerequisite:**

- This is a theoretical calibration, i.e. the points for the linearization table are known.
- The "Level" operating mode has been selected.
- A level calibration in m has been performed.



Note!

For a description of the parameters mentioned, see Operating Instructions.

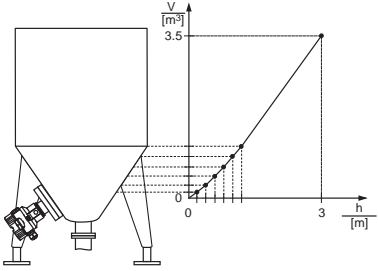
	Description	
1	Select the "Manual entry" option via the "Lin. mode (037)" parameter.  Menu path: Setup → Extended Setup → Linearization → Lin. mode (037)	 <p style="text-align: right; font-size: small;">P01-Mxxxxxxx-19-xx-xx-xx-006</p>
2	Select a unit via the "Unit after lin. (038)" parameter, e.g. m <sup>3</sup> .  Menu path: Setup → Extended Setup → Linearization → Unit after lin. (038)	
3	Enter the number of the point in the table via the "Line numb. (039)" parameter.  Menu path: Setup → Extended Setup → Linearization → Line numb. (039)  The level is entered via the "X-value (040) (manual entry)" parameter, here 0 m for example. Confirm your entry.  Menu path: Setup → Extended Setup → Linearization → X-value (040) (manual entry)  Using the "Y-value (041) (manual entry/in semi-auto. entry)" parameter, enter the associated volume value, here 0 m <sup>3</sup> for example, and confirm the value.  Menu path: Setup → Extended Setup → Linearization → Y-value (041) (manual entry/in semi-auto. entry)	

	<b>Description</b>	
4	To enter another point in the table, select the "Next point" option via the "Edit table (042)" parameter. Enter the next point as explained in Step 3.  Menu path: Setup → Extended Setup → Linearization → Edit table (042)	
5	Once all the points have been entered in the table, select the "Activate table" option via the "Lin. mode" parameter.Lin. mode (037)  Menu path: Setup → Extended Setup → Linearization → Lin. mode (037)	
6	Result: The measured value after linearization is displayed.	



Note!

Error message F510 "Linearization" and status signal "failure" appears as long as the table is being entered and until the table is activated.

## 7.5.2 Manual entry of the linearization table via the operating tool

### Example:

In this example, the volume in a tank with a conical outlet should be measured in m<sup>3</sup>.

### Prerequisite:

- This is a theoretical calibration, i.e. the points for the linearization table are known.
- The "Level" operating mode has been selected.
- A level calibration has been performed.



Note!

For a description of the parameters mentioned, see Operating Instructions.

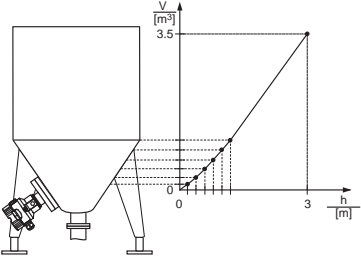

	Description	
1	<p>Select the "Manual entry" option via the "Lin. mode (037)" parameter.</p> <p>Menu path: Setup → Extended Setup → Linearization → Lin. mode (037)</p>	 <p style="text-align: right; font-size: small;">P01-Maxxxxxx-19-xx-xx-xx-006</p>
2	<p>Select via the "Unit after lin. (038)" parameter, e.g. m<sup>3</sup>.</p> <p>Menu path: Setup → Extended Setup → Linearization → Unit after lin. (038)</p>	
3	<p>Enter the number of the point in the table via the "Line numb. (039)" parameter.</p> <p>Menu path: Setup → Extended Setup → Linearization → Line numb. (039)</p>	
	<p>The level is entered via the "X-value (040) (manual entry)" parameter, here 0 m for example. Confirm your entry.</p> <p>Menu path: Setup → Extended Setup → Linearization → X-value (040) (manual entry)</p>	
	<p>Using the "Y-value (041) (manual entry/in semi-auto. entry)" parameter, enter the associated volume value, here 0 m<sup>3</sup> for example, and confirm the value.</p> <p>Menu path: Setup → Extended Setup → Linearization → Y-value (041) (manual entry/in semi-auto. entry)</p>	
4	<p>To enter another point in the table, select the "Next point" option via the "Edit table (042)" parameter.</p> <p>Enter the next point as explained in Step 3.</p> <p>Menu path: Setup → Extended Setup → Linearization → Edit table (042)</p>	
5	<p>Once all the points have been entered in the table, select the "Activate table" option via the "Lin. mode" parameter.Lin. mode (037)</p> <p>Menu path: Setup → Extended Setup → Linearization → Lin. mode (037)</p>	
6	<p>Result: The measured value after linearization is displayed.</p>	



**Note!**

Error message F510 "Linearization" and alarm current appears as long as the table is being entered and until the table is activated.

### 7.5.3 Semi-automatic entry of the linearization table

**Example:**

In this example, the volume in a tank with a conical outlet should be measured in m<sup>3</sup>.

**Prerequisite:**

- The tank can be filled or emptied. The linearization characteristic must rise continuously.
- The "Level" operating mode has been selected.



Note!

For a description of the parameters mentioned, see Operating Instructions.

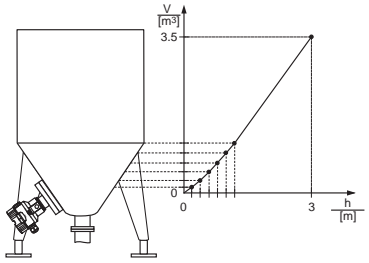
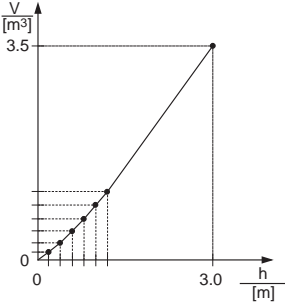
	Description	
1	Select the "Semi-auto. entry" option via the "Lin. mode (037)" parameter.  Menu path: Setup → Extended Setup → Linearization → Lin. mode (037)	
2	Select the volume unit/mass unit via the "Unit after lin. (038)" parameter, e.g. m <sup>3</sup> .  Menu path: Setup → Extended Setup → Linearization → Unit after lin. (038)	
3	Fill the tank to the height of the 1st point.	
4	Enter the number of the point in the table via the "Line numb. (039)" parameter.  Menu path: Setup → Extended Setup → Linearization → Line numb. (039)	 <p style="text-align: right; font-size: small;">P01-Mxxxxxxx-19-xx-xx-xx-006</p>
	The actual level is displayed via the "X-value (040) (manual entry)" parameter.  Menu path: Setup → Extended Setup → Linearization → X-value (040) (manual entry)	
	Using the "Y-value (041) (manual entry/in semi-auto. entry)" parameter, enter the associated volume value, here 0 m <sup>3</sup> for example, and confirm the value.  Menu path: Setup → Extended Setup → Linearization → Y-value (041) (manual entry/in semi-auto. entry)	
5	To enter another point in the table, select the "Next point" option via the "Edit table (042)" parameter. Enter the next point as explained in Step 4.  Menu path: Setup → Extended Setup → Linearization → Edit table (042)	 <p style="text-align: right; font-size: small;">P01-Mxxxxxxx-05-xx-xx-xx-015</p>
6	Once all the points have been entered in the table, select the "Activate table" option via the "Lin. mode (037)" parameter.  Menu path: Setup → Extended Setup → Linearization → Lin. mode (037)	<p style="text-align: right; font-size: small;">P01-Mxxxxxxx-05-xx-xx-xx-015</p> <p><i>Fig. 14: Semi-automatic entry of the linearization table</i></p>
7	Result: The measured value after linearization is displayed.	



**Note!**

Error message F510 "Linearization" and status signal "failure" appears as long as the table is being entered and until the table is activated.

## 7.6 Pressure measurement

### 7.6.1 Calibration without reference pressure (dry calibration)



Note!

Calibration is possible only using FieldCare.

#### Example:

In this example, a device with a 400 mbar (6 psi) sensor is configured for the 0 to +300 mbar (4.35 psi) measuring range, i.e. 0 mbar and 300 mbar (4.35 psi) are assigned.

#### Prerequisite:

This is a theoretical calibration, i.e. the pressure values for the lower and upper range are known.



Note!

Due to the orientation of the device, there may be pressure shifts in the measured value, i.e. the measured value is not zero in a pressureless condition. For information on how to perform position adjustment, see → 28.

	Description
1	Select the "Pressure" measuring mode via the "Measuring mode (005)" parameter.  Menu path: Setup → Measuring mode (005)
2	Select a pressure unit via the "Scale in. Press. eng. unit" element, here "mbar" for example.  Menu path: Setup → Scale in. Press. eng. unit
3	Enter a pressure value of 0 mbar via the "Scale in. Set LRV" element.  Menu path: Expert → Communication → Pressure Transducer Block → Scale in. Set LRV
4	Enter a pressure value of 300 mbar (4.35 psi) via the "Scale in. Set LRV" element.  Menu path: Expert → Communication → Pressure Transducer Block → Scale in. Set LRV
5	Result: The measuring range is configured for 0 to +300 mbar (4.35 psi).

## 8 Commissioning with the FF configuration program



Warning!

- If a pressure smaller than the minimum permitted pressure or greater than the maximum permitted pressure is present at the device, the following messages are output in succession:
  1. "S140 Working range P" or "F140 Working range P" <sup>3)</sup>
  2. "S841 Sensor range" or "F841 Sensor range" <sup>3)</sup>



Note!

The device is configured for the or Pressure measuring mode as standard. The measuring range and the unit in which the measured value is transmitted correspond to the specifications on the nameplate.

### 8.1 Function check

Carry out a post-installation and a post-connection check as per the checklist before commissioning the device.

- "Post-installation check" checklist → 10
- "Post-connection check" checklist → 14

### 8.2 Commissioning



Note!

- The device is configured at the factory for the Pressure measuring mode. The measuring range and the unit in which the measured value is transmitted, as well as the digital output value of the Analog Input Block OUT, correspond to the data on the nameplate. Following a reset with code 7864, the OUT parameter may have to be rescaled (→ see also Page 48, Section 8.3 "Scaling the OUT parameter").
- The standard order configuration is illustrated in the Operating Instructions.
- The "xxxxxxxxxx" characters used in the following sections are placeholders for the serial number.

1. Switch on the device.
2. Note the DEVICE\_ID (see Operating Instructions).
3. Open the configuration program.
4. Load Cff and device description files into the host system or the configuration program. Make sure you are using the right system files.
5. Identify the device using the DEVICE\_ID (→ see Point 2). Assign the desired tag name to the device by means of the "Pd-tag/FF\_PD\_TAG" parameter.

---

3) depending on the setting in the "Alarm behav. P" (050) parameter

## Configuring the Resource Block

1. Open the Resource Block.
2. If necessary, disable the lock for device operation. →  24, Section 5.2.4 "Locking/unlocking operation". Operating is unlocked as standard.
3. If necessary, change the block name. Factory setting: RS-xxxxxxxxxxx (RB2) ()
4. If necessary, assign a description to the block by means of the "Tag Description/TAG\_DESC" parameter.
5. If necessary, change other parameters as per the requirements.

## Configuring the Transducer Blocks

The device has the following Transducer Blocks:

- Pressure Transducer Block
- Display Transducer Block
- Diagnostic Transducer Block

The explanation that follows is an example for the Pressure Transducer Block.

1. If necessary, change the block name. Factory setting: TRD1\_xxxxxxxxxxx (PCD)
2. Set the block mode to OOS by means of the "Block Mode/MODE\_BLK", TARGET element.
3. Configure the device in accordance with the measuring task. → See also these Operating Instructions Section 7.2 to Section 8.3.
4. Set the block mode to "Auto" by means of the "Block Mode/MODE\_BLK" parameter, TARGET element.



Note!

The block mode must be set to "Auto" for the Pressure Block for the measuring device to function correctly.

## Configuring the Analog Input Blocks

The device has 2 Analog Input Blocks that can be assigned as required to the various process variables.

1. If necessary, change the block name. Factory setting: AI1\_xxxxxxxxxxx (AI)
2. Set the block mode to OOS by means of the "Block Mode/MODE\_BLK" parameter, TARGET element.
3. Use the "Channel/CHANNEL" parameter to select the process variable which should be used as the input value for the Analog Input Block. The following settings are possible:
  - Channel/CHANNEL = 1: Primary value, a pressure or level value depending on the measuring mode selected
  - Channel/CHANNEL = 2: Secondary value
  - Channel/CHANNEL = 3: Pressure
  - Channel/CHANNEL = 4: Max. pressure

- Channel/CHANNEL = 5: Level before linearization
- Factory setting:
- Analog Input Block 1: Channel/CHANNEL = 1: Primary Value (primary measured value)
  - Analog Input Block 2: Channel/CHANNEL = 2: Secondary Value (sensor temperature)
4. Use the "Transducer Scale/XD\_SCALE" parameter to select the desired unit and the block input range for the process variable. → 48, Section 8.3 "Scaling the OUT parameter". Make sure that the unit selected suits the process variable selected. If the process variable does not suit the unit, the "Block Error/BLOCK\_ERR" parameter reports "Block Configuration Error" and the block mode cannot be set to "Auto".
  5. Use the "Linearization Type/L\_TYPE" parameter to select the type of linearization for the input variable (factory setting: Direct).  
Make sure that the settings for the "Transducer Scale/XD\_SCALE" and "Output Scale/OUT\_SCALE" parameters are the same for the "Direct" linearization type. If the values and units do not match, the Block Error/BLOCK\_ERR parameter reports "Block Configuration Error" and the block mode cannot be set to "Auto".
  6. Enter the alarm and critical alarm messages by means of the "High High Limit/HI\_HI\_LIM", "High Limit/HI\_LIM", "Low Low Limit/LO\_LO\_LIM" and "Low Limit/LO\_LIM" parameters. The limit values entered must be within the value range specified for the "Output Scale/OUT\_SCALE" parameter.
  7. Specify the alarm priorities by means of the "High High Priority/HI\_HI\_PRI", "High Priority/HI\_PRI", "Low Low Priority/LO\_LO\_PRI" and "Low Priority/LO\_PRI" parameters. Reporting to the field host system only takes place with alarms with a priority greater than 2.
  8. Set the block mode to "Auto" using the "Block Mode/MODE\_BLK" parameter, TARGET element. For this purpose, the Resource Block must also be set to the "Auto" block mode.

### **Additional configuration**

1. Link the function blocks and output blocks.
2. After specifying the active LAS, download all the data and parameters to the field device.

### 8.3 Scaling the OUT parameter

In the Analog Input Block, the input value or input range can be scaled in accordance with the automation requirements.

#### Example:

The measuring range 0 to 500 mbar should be rescaled to 0 to 100 %.

- Select XD\_SCALE group.
  - For EU\_0, enter "0".
  - For EU\_100, enter "500".
  - For UNITS\_INDEX, enter "mbar".
- Select OUT\_SCALE group.
  - For EU\_0, enter "0".
  - For EU\_100, enter "100%".
  - For UNITS\_INDEX, select "%" for example.

The unit selected here does not have any effect on the scaling.

#### ■ Result:

At a pressure of 350 mbar, the value 70 is output to a downstream block or to the PCS as the OUT value.

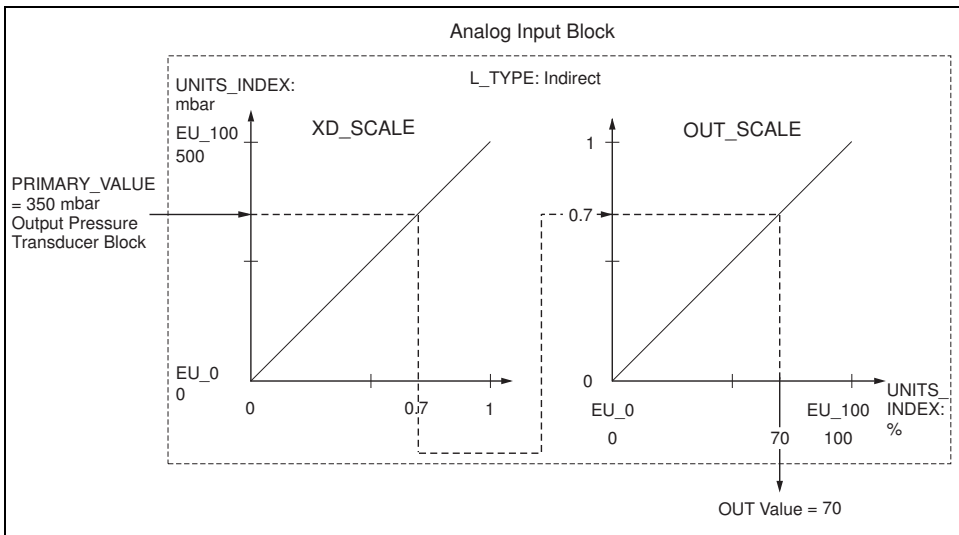

#### Note!

- If you have selected the "Direct" mode for the L\_TYPE parameter, you cannot change the values and units for XD\_SCALE and OUT\_SCALE.
- The L\_TYPE, XD\_SCALE and OUT\_SCALE parameters can only be changed in the OOS block mode.
- Make sure that the output scaling of the Pressure Transducer Block SCALE\_OUT matches the input scaling of the Analog Input Block XD\_SCALE.









[www.endress.com/worldwide](http://www.endress.com/worldwide)

---

**Endress+Hauser**   
People for Process Automation

---

KA01032P/00/EN/04.14  
71269380  
CCS/FM+SGML 9

