



Level



Pressure



Flow



Temperature



Liquid
Analysis



Registration



Systems
Components



Services



Solutions

Technical Information

RTA421

Limit alarm switch

Alarm switch and power supply for monitoring current or voltage signals

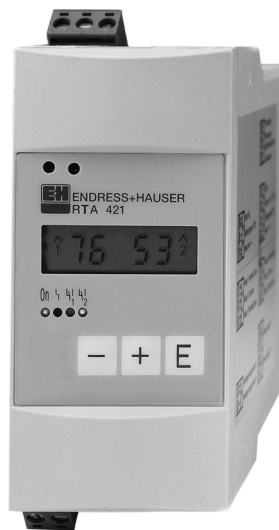

Application

- Plant and machine construction
- Panel builders
- Process monitoring
- Process control

Your benefits

- 2 relays for set point monitoring (with SPDT contacts)
- Loop power supply for connected sensors
- LC display for alarm set points and bar graph
- Compact housing
- Front end setup using 3 push buttons

Function and system design

Measuring system

The RTA421 contactor monitors industrial processes for safe operation. The unit analyses current (0/4...20 mA) and voltage signals (0/2...10 V) and switches two independent output relays if the values either exceed or undercut the preset alarm set points.

Applications include pump control in the waste water industry, level measurement in silos can be economically achieved.

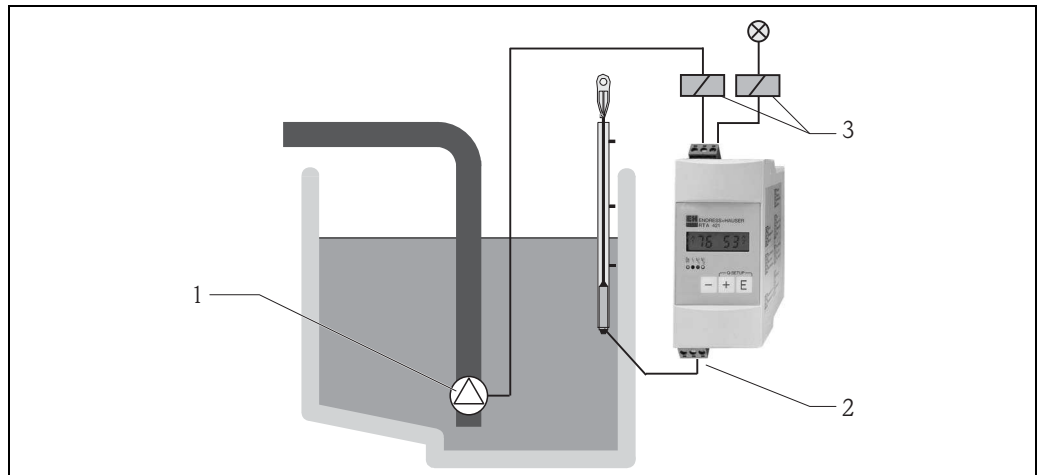

- 1 Pump
2 Signal input with loop power supply
3 Relays

Alarm set point function

Mode	Minimum, Maximum
Switch threshold	00 to 99%
Hysteresis	01 to 99%
Time delay	00 to 99 s
Reaction time	0.4 s

Input

Number	1
Measured variable	Current and voltage
Measuring range	<p>Voltage 0/2...10 V, max. voltage 50 V Ri: 1 MΩ</p> <p>Current 0/4...20 mA; max. current 150 mA Ri: 5 Ω</p>
Resolution	<p>Voltage 41 mV, 8 Bit</p> <p>Current 83 μA, 8 Bit</p>
Overrange	10 %
Integration time	4/s

Output

Output signal	Loop power supply	
	Output signal	Terminal 81: 24 V \pm 20%, 30 mA
	Number	1
	Galvanic isolation	Between power supply and relay outputs
Relays		
Output signal	Binary, switches when alarm set point is reached	
Number	2	
Contact type	SPDT potential free contact per relay	
Contact load	\leq 250 VAC, 8(2) A / 30 VDC, 5(2) A	

Power supply

Terminal assignment

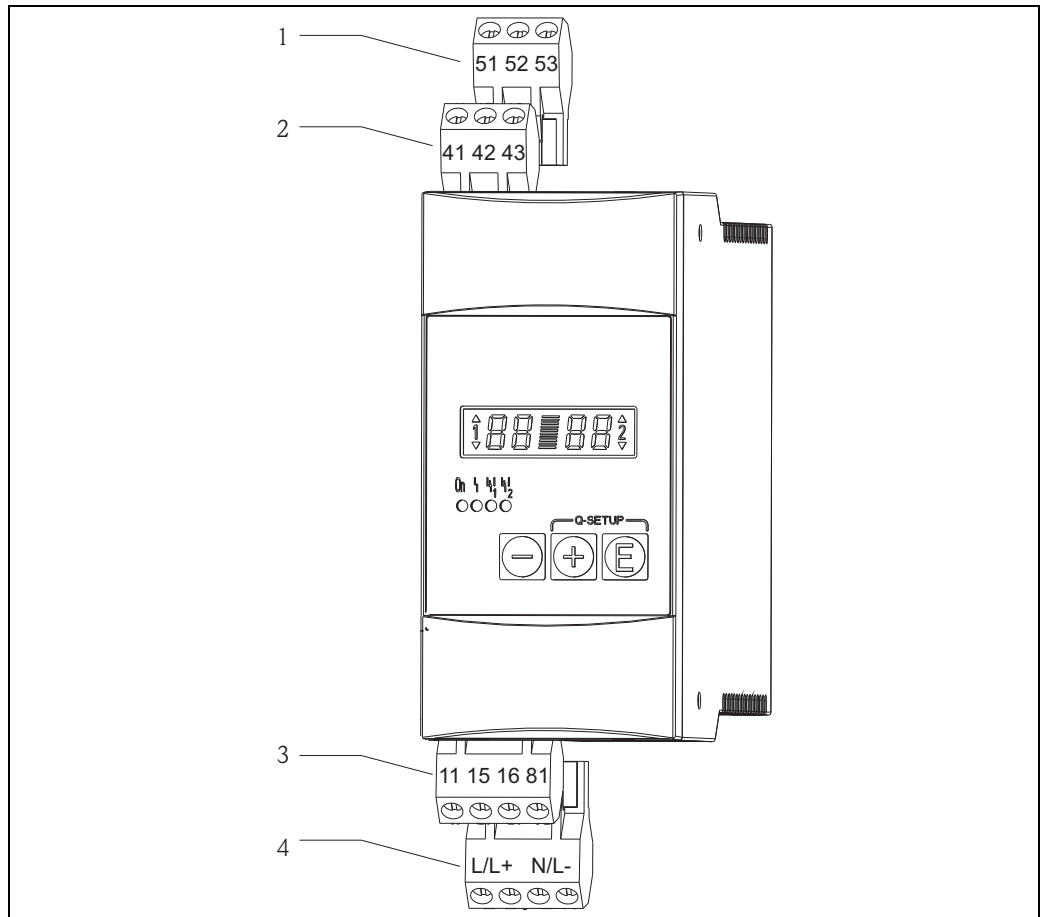

- 1 Relay 2
 2 Relay 1
 3 Analog input with loop power supply
 4 Power supply (20...250 V DC/AC, 196...250 V AC, 98...128 V AC)

Supply voltage 196...250 VAC, 50/60 Hz
 98...126 VAC, 50/60 Hz
 20...250 VDC/AC, 50/60 Hz

Power consumption Max. 9 VA

Electrical connection

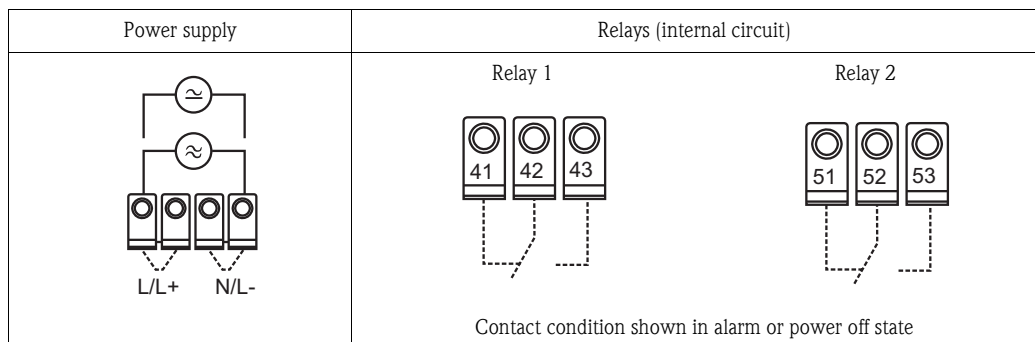

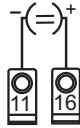
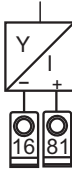
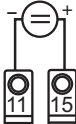
Current input	Current input with loop power supply	Voltage input
0/4...20 mA	4...20 mA	0/2...10 V DC
		

Terminals	Keyed, plug on screw terminals, core sizes flexible to 2.5 mm ² (13 AWG)
Fuse	315 mA, slow blow
Input current limit	$I_{\max} / I_n < 15$
Overvoltage protection	As per IEC 61010-1 Overvoltage category II, Installation area excessive current system ≤ 10 A

Performance characteristics

Maximum measured error	Voltage / current Accuracy: 1% FSD
Influence of ambient temperature	Voltage / current Temperature drift: 0.02% / K (0.011% / °F) of ambient temperature

Installation

Orientation	no restrictions
--------------------	-----------------

Environment

Ambient temperature range	-20 °C...+70 °C (-4...+158 °F)
Storage temperature	-20 °C...+70 °C (-4...+158 °F)
Climate class	As per IEC 60 654-1 Class B3
Degree of protection	IP20
Altitude	Up to 2000 m (6560 ft.) above sea level according to IEC 61010-1 (EN 61010-1), CSA 1010.1-92
Electromagnetic compatibility	As per IEC 61326, Class A (industrial environment)

Mechanical construction

Design, dimensions

Housing for top hat DIN rail mounting to IEC 60715 TH35
H: 110 mm (4.33 in), W: 45 mm (1.77 in), D: 112 mm (4.41 in)

Dimensions

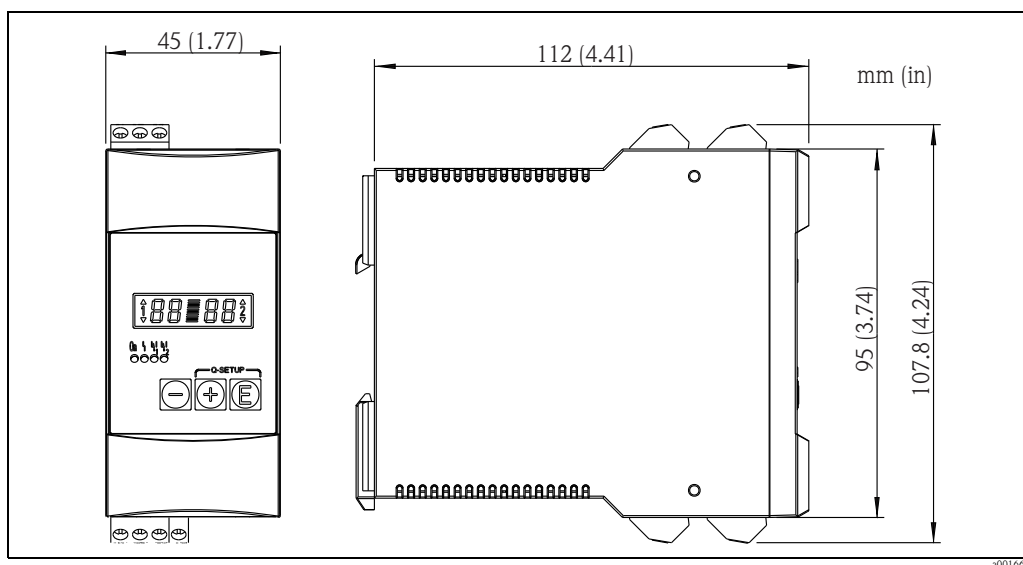

Weight

approximately 150 g (0.33 lb.)

Materials

Housing: Plastic PC/ABS, UL 94V0

Operability

Operating concept

Quick Set

The unit is fitted with a quick set up menu so that if the set points are to be frequently changed this feature can be started by operating the “+” and “E” push buttons. This means that the set points SP1 and SP2 can be easily changed even during operation without opening the setting up menu. If required a 2 digit security code is available in order to stop any changes being made to the alarm set points.

Local operation

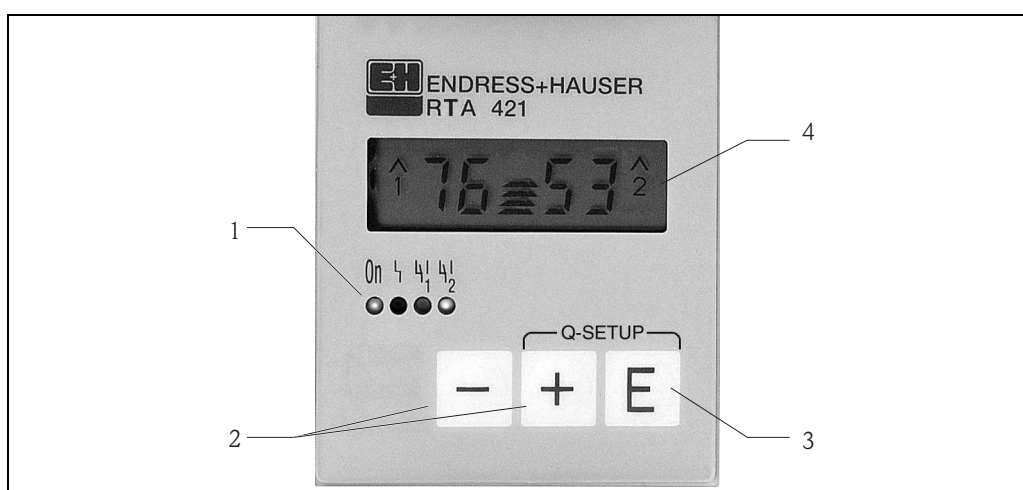

- 1 LED's: Operational display, fault display, condition display set point relays
- 2 Selection keys
- 3 Enter key
- 4 4 digit LC display with alarm markings and bargraph

Both set points are simultaneously visible in the display. The ten segment bargraph additionally displays the percentage value of the connected signal. The actual percentage measured value in the measurement circuit can be displayed by operating either the “+” or “-” push button.

Display

LED:

Operation, 1 x green
Fault condition, 1 x red
Alarm set point, 2 x yellow

LC display:

Numeric display: 4 x 7 segments
Alarm set point condition: 2 x channel number, 4 x 1 segment
Bargraph: 10 x 1 segment

Display range

2 x 0 to 99%

Operation

3 key operation (-/+/E)

Certificates and approvals

CE mark

Guidelines 89/336/EWG and 73/23/EWG

Ordering information

Detailed ordering information is available from the following sources:

- In the Product Configurator on the Endress+Hauser website: www.endress.com → Select country → Instruments → Select device → Product page function: Configure this product
- From your Endress+Hauser Sales Center: www.endress.com/worldwide



Note!

Product Configurator - the tool for individual product configuration

- Up-to-the-minute configuration data
- Depending on the device: Direct input of measuring point-specific information such as measuring range or operating language
- Automatic verification of exclusion criteria
- Automatic creation of the order code and its breakdown in PDF or Excel output format
- Ability to order directly in the Endress+Hauser Online Shop

Accessories

Field housing

IP66 protective housing for field mounting
Order no. 51002468

Documentation

Standard documentation

Operating instructions BA00101R/09/

Instruments International

Endress+Hauser
Instruments International AG
Kaegenstrasse 2
4153 Reinach
Switzerland

Tel.+41 61 715 81 00
Fax+41 61 715 25 00
www.endress.com
info@ii.endress.com

Endress+Hauser 
People for Process Automation