

Technical Information

Memograph M

Advanced Graphic Data Manager RSG40

Record, visualize, analyze and communicate



Application

The graphic data manager Memograph M provides information on all the relevant process variables. Measured values are recorded correctly, limit values are monitored and measuring points analyzed. The data are stored in the 256 MB internal memory and also on an SD card or USB stick. Memograph M boasts a modular design, intuitive operation and a comprehensive security concept. The ReadWin 2000 PC software is part of the standard package and is used for configuring, visualizing and archiving the data captured. The solution for all your tasks. For example, for:

- Process measuring technology
- Power stations and energy supply
- Steam boiler monitoring/efficiency calculation
- Food and pharmaceutical industry
- Plant and apparatus engineering and construction; Milk pasteurization plants
- Environmental and climate measuring technology; Storm overflow control
- Quality assurance and production
- Batch analysis; Tele-Alarm functions
- Testing bays and laboratory applications

Your benefits

- **Visual:** 7" TFT display as onsite display for optimum readability
- **Fast:** 100 msec scan rate for all channels, high-speed memory cycle 100 msec for up to 8 channels
- **Secure:** Security package with person-specific access authorization and electronic signature (FDA 21 CFR 11)
- **Modular:** Easy retrofitting to up to 20 universal inputs and 14 digital inputs or 12 relays
- **Flexible:** Free choice of display mode. E.g. instrument, process screen and circular chart display
- **Limitless:** Integrated Web server, fieldbus (Profibus, Modbus), common standard protocols and interfaces such as USB, TCP/IP, OPC and Ethernet are supported
- **Informative:** Event search, automatic signal analysis
- **Practicable:** Installation depth 158 mm, front-panel IP65, NEMA4; Operating via external USB keyboard, printout via USB printer
- **Clear:** Alarm management with all active, confirmed and historical alarms

Function and system design

Measuring principle Electronic acquisition, display, recording, analysis, remote transmission and archiving of analog and digital input signals.

Measuring system Multichannel data recording system with multicolored TFT display (170 mm/7" screen size), galvanically isolated universal inputs (U, I, TC, RTD, pulse, frequency), digital input, transmitter power supply, limit relay, communication interfaces (USB, Ethernet, RS232/485), internal SD memory, external SD card and USB stick. 100 ms scan rate for all channels. ReadWin 2000 PC software for comprehensive device configuration and data evaluation.

 The number of inputs, outputs and relays contained in the basic device can be individually extended using a maximum of five plug-in cards. The Memograph M provides power directly to connected two-wire transmitters. The device is configured and operated via 4 keys and the navigator (jog/shuttle dial) by means of the interface and ReadWin 2000 PC software or an external keyboard. The online help makes onsite operation easier. Measured values, events and alarms are coded in accordance with the serial protocol and then transmitted.

Block circuit diagram

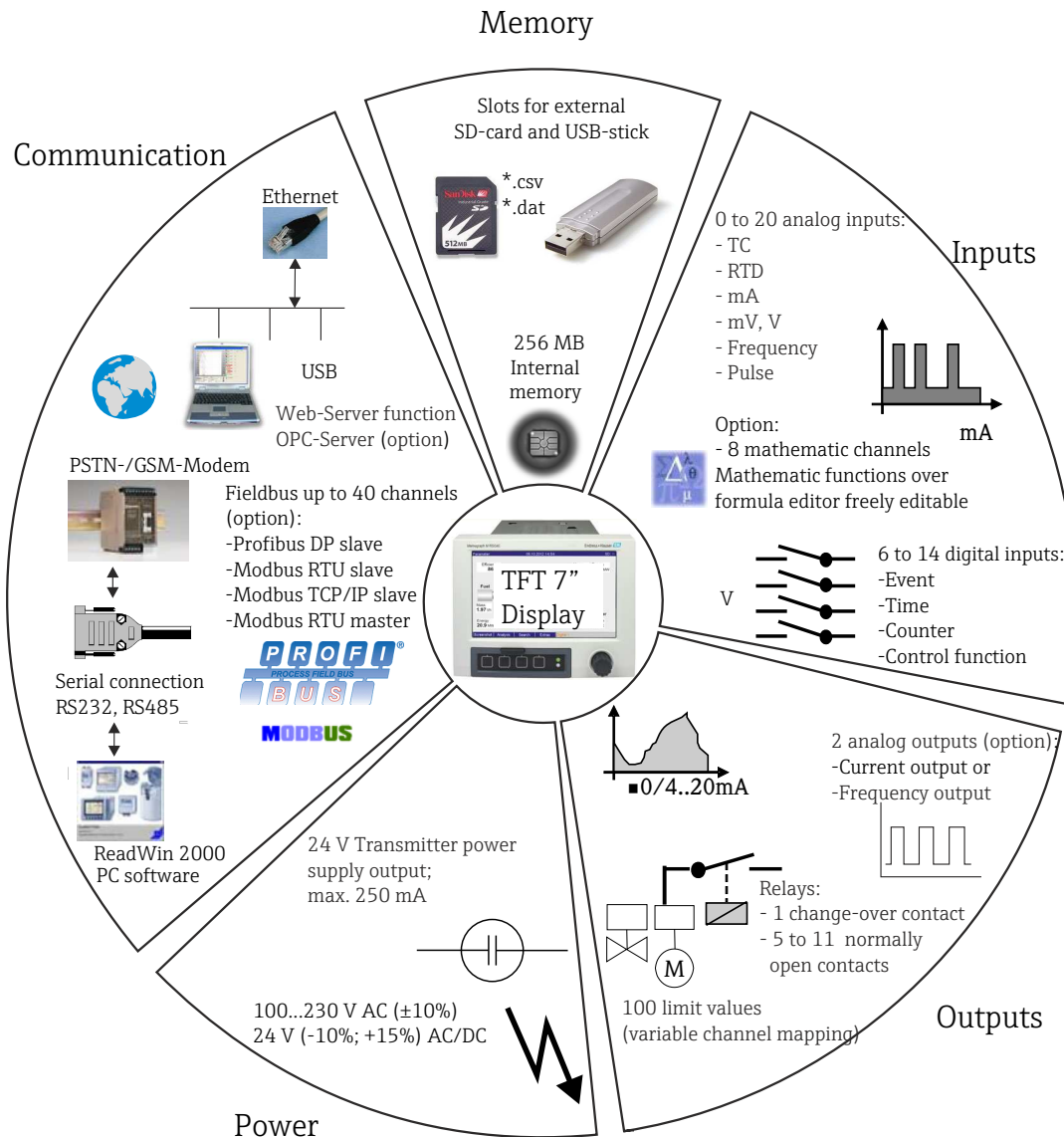

This block circuit diagram provides a rough overview of the functions.

**Application packages/
software options**

User-friendly function extension (even subsequently) through the online activation of all the optional instrument functions. The following software options are available:

Functions	Software package					
	Standard incl. security package	Mathematics package	Batch	Tele Alarm	Waste water + Storm overflow + Tele Alarm	Energy software, water + steam
Process-related graphic	X	X	X	X	X	X
Signal analysis: day, week, month, year, external (digital input)	X	X	X	X	X	X
Event messages/Audit Trail	X	X	X	X	X	X
Operation time counter	X	X	X	X	X	X
Text entry/comments	X	X	X	X	X	X
Change language	X	X	X	X	X	X
Time synchronization	X	X	X	X	X	X
Web server	X	X	X	X	X	X
Linearization	X	X	X	X	X	X
External USB keyboard	X	X	X	X	X	X
External USB printer	X	X	X	X	X	X
User administration 21 CFR Part 11	X	X	X	X	X	X
Access protection through release code	X	X	X	X	X	X
Mathematics functions via formula editor		X	X	X	X	X
Logic operations		X	X	X	X	X
Mass, heat quantity, water, steam						X
Efficiency calculation						X
Parallel batch record for 4 batches			X			
USB bar code scanner			X			
Automatic batch printout			X			
Preset counter			X			
SMS/Email communication at the event of an alarm				X	X	

Functions	Software package					
	Standard incl. security package	Mathematics package	Batch	Tele Alarm	Waste water + Storm overflow + Tele Alarm	Energy software, water + steam
Querying values by cellular phone/SMS				X	X	
Remote controlled relays				X	X	
Alarm confirming via SMS				X	X	
Storm overflow control (rain spillway basins)					X	
Floating highest and lowest values for quantities					X	
Floating highest and lowest values of x-minute average values					X	
Infiltration water analysis					X	

Energy software

The Memograph M energy package provides users with the possibility of calculating the mass and energy flow in water and steam applications on the basis of the following input variables:

- Flow
- Pressure
- Temperature (or temperature differential)

Furthermore, energy calculations are also possible using glycol-based refrigerant media.

By balancing the results against one another or by linking the results to other input variables (e.g. gas flow, electr. energy), users can perform overall balances, calculate efficiency levels etc. These values are important indicators for the quality of the process and form the basis for process optimization efforts, maintenance, etc.

The internationally recognized IAPWS-IF 97 standard is used to calculate the thermodynamic state variables of water and steam.

Tele-alarm software package

With the tele-alarm software it is possible to react even when on the road. E-mails or SMS messages triggered by process alarms or other important process events can be transmitted simultaneously to several recipients or can be automatically forwarded. Reports can be confirmed, relays remotely switched and instantaneous measurements retrieved via mobile telephones. Memograph M with GSM (GPRS) or Ethernet connection is the perfect solution in the environmental industry for applications supervising unmanned outstations but also ideally suitable for tank level supervision.

Batch software package

The new Batch software allows for secure recording and visualization of discontinuous processes. Freely definable or externally controlled evaluation cycles are simultaneously possible for up to four batches. Batches are provided with batch specific information and the measurement readings, the beginning, the end and the duration of every batch are displayed on the device and in the ReadWin 2000 software with the current batch status. A batch printout at the end of each batch can be done directly at the device (USB printer) or can be printed out using a PC with ReadWin 2000.

Water/waste water software package

A Memograph M with the water/waste water software supports in the operational supervision of the water/waste water channel systems by recording information regarding the quality and economics of the treatment plant. For each supply channel the daily, weekly, monthly, yearly highest and lowest values are recorded. Seepage water recording as well as the supervision of storm overflow tanks for overflow events are also a part of this software application package.

IT security

We only provide a warranty if the device is installed and used as described in the Operating Instructions. The device is equipped with security mechanisms to protect it against any inadvertent changes to the device settings.
 IT security measures in line with operators' security standards and designed to provide additional protection for the device and device data transfer must be implemented by the operators themselves.

Input

Analog multifunction inputs

Number

Standard version without universal inputs.
 Optional multifunction input cards (slot 1-5) each with 4 universal inputs (4/8/12/16/20).

Function

You can choose between the measured variables U, I, RTD, TC, pulse input or frequency input for each universal input.

Measured variable, measuring range

To IEC 60873-1:
 An additional display error of ± 1 digit is permitted for every measured value.
 Measuring ranges which can be selected per channel:

Measured variable	Measuring range	Maximum measured error of measuring range (oMR)	Input resistance
Current (I)	0 to 20 mA 0 to 5 mA 4 to 20 mA Overrange: up to 22 mA	$\pm 0.1\%$ oMR	Load: ≤ 50 Ohm
Voltage (U) >1 V	0 to 10 V 0 to 5 V 1 to 5 V ± 10 V ± 30 V	$\pm 0.1\%$ oMR	≥ 1 MOhm
Voltage (U) ≤ 1 V	0 to 1 V ± 1 V ± 150 mV	$\pm 0.1\%$ oMR	≥ 2.5 MOhm
Resistance thermometer (RTD)	Pt100: -200 to 850 °C (-328 to 1562 °F) (IEC 60751, $\alpha=0,00385$) Pt100: -200 to 850 °C (-328 to 1562 °F) (GOST 6651-94, $\alpha=0,00391$) Pt100: -200 to 510 °C (-328 to 950 °F) (JIS C1604, $\alpha=0,003916$) Pt500: -200 to 850 °C (-328 to 1562 °F) (IEC 60751, $\alpha=0,00385$) Pt500: -200 to 510 °C (-328 to 950 °F) (JIS C1604, $\alpha=0,003916$) Pt1000: -200 to 600 °C (-328 to 1112 °F) (IEC 60751, $\alpha=0,00385$) Pt1000: -200 to 510 °C (-328 to 950 °F) (JIS C1604, $\alpha=0,003916$)	4-wire: $\pm 0.1\%$ oMR 3-wire: $\pm(0.1\%$ oMR + 0.8 K) 2-wire: $\pm(0.1\%$ oMR + 1.5 K)	
	Cu100: -200 to 200 °C (-328 to 392 °F) (GOST 6651-94, $\alpha=0,00428$) Cu50: -200 to 200 °C (-328 to 392 °F) (GOST 6651-94, $\alpha=0,00428$) Pt50: -200 to 850 °C (-328 to 1562 °F) (GOST 6651-94, $\alpha=0,00391$)	4-wire: $\pm 0.2\%$ oMR 3-wire: $\pm(0.2\%$ oMR + 0.8 K) 2-wire: $\pm(0.2\%$ oMR + 1.5 K)	
	Cu53: -50 to 180 °C (-58 to 356 °F) (GOST 6651-94, $\alpha=0,00428$) Pt46: -200 to 650 °C (-328 to 1202 °F) (GOST 6651-94, $\alpha=0,00391$)	4-wire: $\pm 0.3\%$ oMR 3-wire: $\pm(0.3\%$ oMR + 0.8 K) 2-wire: $\pm(0.3\%$ oMR + 1.5 K)	

Measured variable	Measuring range	Maximum measured error of measuring range (oMR)	Input resistance
Thermocouples (TC)	Typ B (Pt30Rh-Pt6Rh): 42 to 1820 °C (108 to 3308 °F) (IEC 60584-1) Typ C (W5Re-W26Re): 0 to 2315 °C (32 to 4199 °F) (IEC 60584-1) Typ D (W3Re-W25Re): 0 to 2315 °C (32 to 4199 °F) (ASTM E998-96) Typ J (Fe-CuNi): -210 to 1200 °C (-346 to 2192 °F) (IEC 60584-1) Typ K (NiCr-Ni): -270 to 1300 °C (-454 to 2372 °F) (IEC 60584-1) Typ N (NiCrSi-NiSi): -270 to 1300 °C (-454 to 2372 °F) (IEC 60584-1) Typ R (Pt13Rh-Pt): -50 to 1768 °C (-58 to 3214 °F) (IEC 60584-1) Typ S (Pt10Rh-Pt): -50 to 1768 °C (-58 to 3214 °F) (IEC 60584-1) Typ T (Cu-CuNi): -270 to 400 °C (-454 to 752 °F) (IEC 60584-1) Typ L (Fe-CuNi): -200 to 900 °C (-328 to 1652 °F) (DIN43710) Typ L (NiCr-CuNi): -200 to 659 °C (-328 to 1218,2 °F) (GOST R8.585-01)	±0,15% oMR as of 600 °C (1112 °F) ±0,15% oMR as of 500 °C (932 °F) ±0,15% oMR as of 500 °C (932 °F) ±0,1% oMR as of -100 °C (-148 °F) ±0,1% oMR as of -130 °C (-202 °F) ±0,1% oMR as of -100 °C (-148 °F) ±0,15% oMR as of 100 °C (212 °F) ±0,15% oMR as of 100 °C (212 °F) ±0,1% oMR as of -200 °C (-328 °F) ±0,1% oMR as of -100 °C (-148 °F) ±0,1% oMR as of -100 °C (-148 °F)	≥1 MOhm
Pulse input (I)¹⁾	Min. pulse length 30 µs, max. 13 kHz		
Frequency input (I)¹⁾	0 to 10 kHz, overrange: to 12.5 kHz 0...7 mA = LOW 13...20 mA = HIGH	±0.01% oMR	Load: ≤50 Ohm

1) If an universal input is used as a frequency or pulse input and the voltage is >2.5 V, a resistance must be used in series connection with the voltage source. Example: 1.2 kOhm series resistance at 24 V

Maximum input load

Limit values for input voltage and input current as well as cable open circuit detection/line influence/temperature compensation:

Measured variable	Limit values (steady-state, without destroying input)	Cable open circuit detection/line influence/temperature compensation
Current (I)	Maximum permitted input voltage: 2.5 V Maximum permitted input current: 50 mA	4 to 20 mA range with disengageable cable open circuit detection as per NAMUR NE43. The following error ranges apply if NE43 is activated: ≤3.8 mA: underrange (display shows: vvvvvv) ≥20.5 mA: overrange (display shows: ^^^^^^) ≤3.6 mA or ≥21.0 mA: cable open circuit (display: - - - -)
Pulse, frequency (I)	Maximum permitted input voltage: 2.5 V Maximum permitted input current: 50 mA Minimum pulse length: 30 µs Maximum 13 kHz	No cable open circuit monitoring
Voltage (U) >1 V	Maximum permitted input voltage: 35 V	1 to 5 V range with disengageable cable open circuit detection: <0.8 V or >5.2 V: cable open circuit (display: - - - -)
Voltage (U) ≤ 1 V	Maximum permitted input voltage: 24 V	
Resistance thermometer (RTD)	Measuring current: ≤1 mA	Maximum barrier resistance (or line resistance): Max. 200 Ohm (4-wire) Max. 40 Ohm (3-wire) Maximum influence of barrier resistance (or line resistance) for Pt100, Pt500 and Pt1000: 4-wire: ±0.0002%/Ohm, 3-wire: ±0.002%/Ohm Maximum influence of barrier resistance (or line resistance) for Pt46, Pt50, Cu50, Cu53 and Cu100: 4-wire: ±0.0006%/Ohm, 3-wire: ±0.006%/Ohm
Thermocouples (TC)	Maximum permitted input voltage: 24 V	Cable open circuit detection from 50 kOhm Influence of line resistance in event of break detection: < 0.001%/Ohm Error, internal temperature compensation: ≤ 2 K

Scan rate

All channels are scanned within 100 ms.

Converter resolution

24 bit

Totalization

The interim value, daily value, weekly value, monthly value, annual value and overall value can be determined (13-digit, 64 bit).

Digital inputs

Number

Standard version: 6 digital inputs
Optional digital card (slot 5): 8 additional digital inputs

Input level

To IEC 61131-2:
Logical "0" (corresponds to -3 to +5 V), activation with logical "1" (corresponds to +12 to +30 V)

Input frequency

Max. 25 Hz

Pulse length

Min. 20 ms

Input current

Max. 2 mA

Input voltage

Max. 32 V (steady-state, without destroying input)

Selectable functions

Control input, ON/OFF message, pulse counter (13-digit, 64 bit), operating time, message+operating time, quantity from time.
Functions of the control input: start recording, screensaver on, block setup, block keyboard/navigator, time synchronization, change group, limit value monitoring on/off, individual LV on/off, start/stop evaluation.

Output

Auxiliary voltage output

The auxiliary voltage is provided to activate the digital input (or the sensors) with floating contacts and is galvanically isolated from the system and the inputs (testing voltage 500 V).

Output voltage:

24 V DC ($\pm 15\%$)

Output current:

Maximum 250 mA, short-circuit proof, not stabilized

Relay outputs

Standard version (power supply slot): 1 alarm relay with changeover contact, 5 relays with NO contact e.g. for limit value alarms (can be configured as NC contact).

Optional digital card (slot 5): 6 additional relays with NO contact e.g. for limit value alarms (can be configured as an NC contact).



It is not permitted to mix low voltage and safety extra low voltage (do not mix SELV circuits and low voltage).

Response time:

max. 400 ms

Maximum DC contact load:

30 V / 3 A

Maximum AC contact load:

230 V / 3 A

Analog and pulse outputs

Number:

Optional digital card (slot 5): 2 analog outputs which can be operated as current or pulse outputs.

Analog output (current output):

Output current: 0/4 to 20 mA with 10% overrange
 Max. output voltage: approx. 16 V
 Accuracy: ≤0.1% of output range
 Temperature drift: ≤0.015%/K
 Resolution: 13 bit
 Load: 0 to 500 Ohm
 Error signal to NAMUR NE43: 3.6 mA or 21 mA can be configured

Digital output (pulse output):

Output voltage as per IEC 61131-2:
 ≤5 V corresponds to LOW
 ≥12 V corresponds to HIGH
 Short-circuit proof (maximum 25 mA)

Frequency: 0 to 2 kHz
 Pulse width: 0.5 to 1000 ms
 Accuracy: ≤0.1% of output range
 Temperature drift: ≤0.1%
 Load: ≥1 kOhm

Galvanic isolation

All the inputs and outputs are galvanically isolated from one another and tested with the following testing voltages:

	Relay	Digital in	Analog in	Analog out
Relay	2.3 kV	2.3 kV	2.3 kV	2.3 kV
Digital in	2.3 kV	500 V ¹⁾	500 V	500 V
Analog in	2.3 kV	500 V	500 V	500 V
Analog out	2.3 kV	500 V	500 V	500 V

1) Not galvanically isolated from one another. Galvanic isolation is only available for digital inputs between the power unit and the optional digital card.

Power supply / terminal diagram

Electrical connection (wiring diagram)

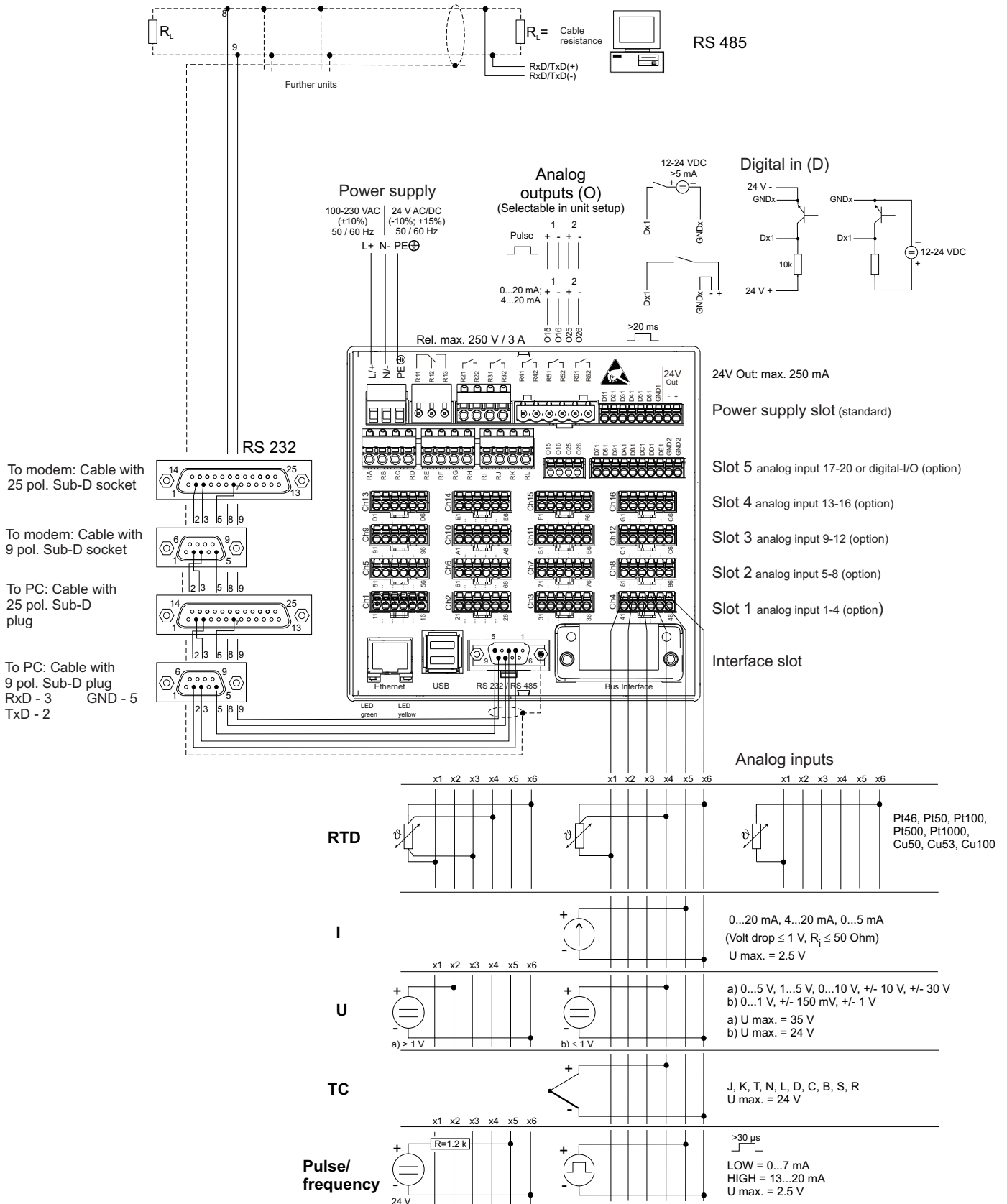

Supply voltage Low voltage power unit: 100...230 V_{AC} (±10%)
Extra-low voltage power unit: 24 V (-10%; +15%)_{AC/DC}

Frequency Nominal frequency: 50 / 60 Hz

Cable specification Screw or spring terminal blocks with reverse polarity protection:
Wire cross-section, digital I/O and analog inputs: max. 1.5 mm² (14 AWG) (spring terminals)
Wire cross-section, power supply: max. 2.5 mm² (13 AWG) (screw terminals)
Wire cross-section, relays: max. 2.5 mm² (13 AWG) (spring terminals)

Power consumption 100...230 V: max. 40 VA
24 V: max. 40 VA

Connection data interface, communication, operation

USB ports:

USB at the front of the unit

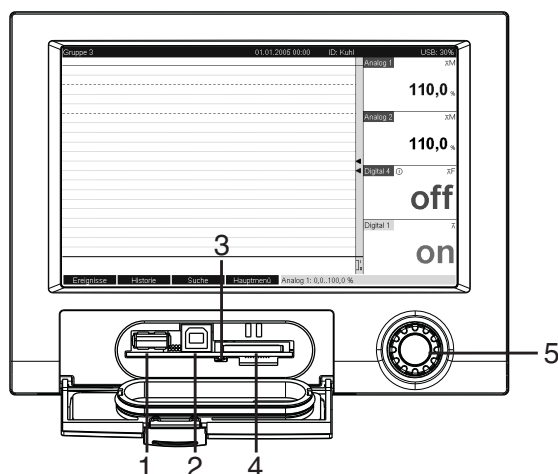

Front of unit with open flap/keyboard

- 1: USB A socket "host" e.g. for USB memory stick, external keyboard, bar code reader or printer
2: USB B socket "Function" e.g. to connect to PC or laptop
3: LED at SD slot. Yellow LED lit when the unit writes to the SD card or reads it.
4: Slot for SD card
5: Navigator

1 x USB connection, type A (host)

A USB 2.0 connection is available on a shielded USB A socket at the front of the unit. A USB stick as a memory medium, a keyboard, a USB hub, a bar code reader or a printer (PCL5c or higher) can be connected to this interface.

1 x USB connection, type B (function)

A USB 2.0 connection is available on a shielded USB B socket at the front of the unit. This can be used to connect the unit for communication with a laptop for example.

USB at the rear of the unit

2 x USB connection, type A (host) (interface slot)

Two USB 2.0 connections are available on shielded USB A sockets at the rear of the unit. A USB stick as a memory medium, a keyboard, a USB hub, a bar code reader or a printer (PCL5c or higher) can be connected to these interfaces.



- The USB 2.0 connections are compatible with USB 1.1, i.e. communication is possible.
- The assignment of the USB ports corresponds to the standard such that shielded standard cables with a maximum length of 3 meters (9.8 ft) can be used here.
- Multiple USB sticks cannot be operated simultaneously. The USB stick that was first connected has priority.

USB printer reference list:

HP Color LaserJet CP1515n, HP Color LaserJet Pro CP1525n, Kyocera FS-C5015N



The printer must support PCL5c (or higher). GDI printers are not supported!

USB bar code reader reference list:

Datalogic Gryphon D230; Metrologic MS5100 Eclipse Series; Symbol LS2208

Ethernet interface (interface slot):

An IEEE 802.3-compatible connection is available on a shielded RJ45 plug connector on the rear of the unit as the network connection. This can be used to connect the unit with a hub or switch to units in an office environment. For safe spacing distances, the office equipment standard EN 60950 must be observed. The assignment corresponds to a standards-compliant MDI port (AT&T258) such that a shielded 1:1 cable with a maximum length of 100 meters (328 ft) can be used here. The Ethernet port is designed as 10/100-BASE-T. Direct connection to a PC is possible with a crossover cable. Half-duplex and full-duplex data transfer is supported. Alternatively, a GPRS modem can also be connected to the Ethernet interface.

The unit can be used in the network as a "Web server". Two Ethernet function LEDs on the rear of the unit.

Serial RS232/RS485 interface (interface slot):

A combined RS232/RS485 connection is available on a shielded SUB D9 socket at the rear of the unit. This can be used for data or program transfer and to connect a modem. For communication via modem, we recommend an industrial modem with a watchdog function.

The following baudrates are supported: 1200, 2400, 4800, 9600, 19200, 38400, 57600, 115200
Max. line length with shielded cable: 2 m (6.6 ft) (RS232) or 1000 m (3281 ft) (RS485)

Both interfaces are galvanically isolated from the system.

The RS232/RS485 interfaces cannot be used simultaneously.

- Modbus RTU master (optional):

As Modbus master, the device can scan other Modbus slaves via RS485. The Modbus RTU master can be operated parallel to the Profibus-DP slave, Modbus RTU slave or Modbus TCP slave.

Remote interrogation with analog or GSM/GPRS wireless modem:

- Analog modem:

An analog modem (e.g. Devolo or WESTERMO), which is connected to the RS232 interface with a special modem cable (see Accessories RXU10-A1), is recommended for industry.

- GSM/GPRS wireless modem:

A GSM/GPRS wireless modem (e.g. Siemens, INSYS or WESTERMO, incl. antenna and power unit), which is connected to the RS232 interface with a special modem cable (RXU10-A1 accessory), is recommended for industry. Important: the wireless modem needs a SIM card and data transfer subscription. In addition, it must be possible to deactivate the PIN prompt.

Bus interface (interface slot, optional)

- PROFIBUS-DP slave:

The unit can be integrated into a fieldbus system as per the PROFIBUS-DP standard by means of the PROFIBUS-DP interface. Up to 40 analog inputs and 14 digital inputs can be transmitted via PROFIBUS-DP and stored in the unit. For bidirectional communication in cyclic data transfer.
Baudrate: maximum 12 Mbit/s

- Modbus RTU slave:

Up to 40 analog inputs and 14 digital inputs can be transmitted via Modbus and stored in the unit.

- Ethernet Modbus TCP slave:

Connection to SCADA systems (Modbus master). Up to 40 analog inputs and 14 digital inputs can be transmitted via Modbus and stored in the unit.

Performance characteristics

Reference operating conditions	Ambient temperature: 25 °C ±5 K (77 °F ±9 °F) Air humidity: 55% ±10% r.h.
Maximum measured error	(See Input)
Temperature drift	Cu50, Cu53, Cu100, Pt46 and Pt50: max. ±0.02%/K (of measuring range) All other ranges: max. ±0.01%/K (of measuring range)
Long-term drift	To IEC 61298-2: max. ±0.1%/year (of measuring range)

Installation

Orientation Operating position as per DIN 16 257, NL 90 ±30°

Installation instructions Panel cutout and installation / design, dimensions:

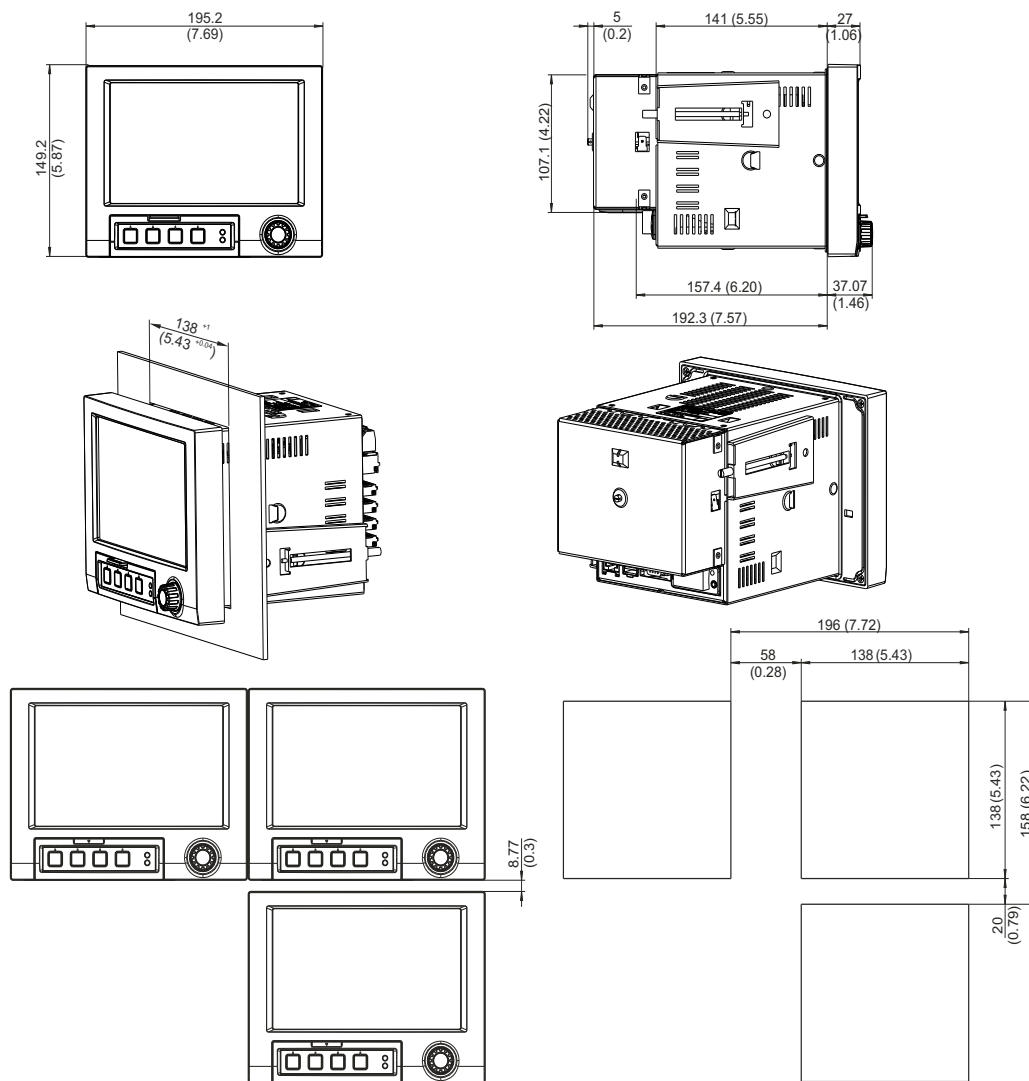

All dimensions in mm or (inch)

- Installation depth without terminal cover: approx. 158 mm (6.22") (incl. terminals and fastening clips)
- Installation depth with terminal cover: approx. 197 mm (7,76")
- Panel cutout: 138⁺¹ x 138⁺¹ mm (5.43^{+0.04} x 5.43^{+0.04"})
- Panel thickness: 2 to 40 mm (0.08 to 1.58")
- Max. viewing angle range: from the display central axis 50° in all directions
- Securing to DIN 43 834



- A distance of min. 7 mm (0.28 inch) between the devices has to be observed if aligning the devices in the Y-direction (vertically above one another).
- The devices can be arranged horizontally beside one another in the X direction without any spacing between the devices.
- The grid dimension of the panel cutouts for multiple devices must be min. 196.2 mm (7.72") horizontally and min. 156.2 mm (6.15") vertically (tolerance not considered).

Environment

Ambient temperature range	-10 to 50 °C (14 to 122 °F)
Storage temperature	-20 to +60 °C (-4 to 140 °F)
Climate class	To IEC 60654-1: B1
Degree of protection	Front-panel IP65 (IEC 60529, Cat. 2) NEMA 4 Rear-panel IP20 (IEC 60529, Cat. 2)
Electrical safety	IEC 61010-1, protection class I Low voltage: overvoltage category II Environment <3000 m (<9843 ft) above MSL (mean sea level)
Electromagnetic compatibility (EMC)	<p>Interference immunity:</p> <p>To IEC 61326 (industrial environment) and NAMUR NE21:</p> <ul style="list-style-type: none"> ■ ESD (electrostatic discharge): IEC 61000-4-2 severity 3 (6/8 kV) ■ HF field (electromagnetic interference fields): IEC 61000-4-3: severity 3 (10 V/m) ■ Burst (quick transient disturbance variables): IEC 61000-4-4 severity 3 (1 kV signal, 2 kV power supply) ■ Surge on power line: IEC 61000-4-5: 2 kV asymmetrical, 1 kV symmetrical ■ Surge on signal line: IEC 61000-4-5: 1 kV asymmetrical (with external protection element) ■ Conducted HF: IEC 61000-4-6: 150 kHz to 80 MHz, 10 V ■ Power failure: IEC 61000-4-11 (>20 ms/0%) ■ Voltage variation: IEC 61000-4-11 (40% / 0%) <p>Emission:</p> <p>To IEC 61326: Class A (operation in industrial environment)</p> <p>Interference voltage:</p> <p>Power cable: To CISPR 16-1/-2: Class A</p> <p>Interference current:</p> <p>Ethernet cable: To EN 50022: Class A</p> <p>Interference field intensity:</p> <p>Housing/all connections: To CISPR 16: Class A</p> <p>Interference voltage suppression:</p> <ul style="list-style-type: none"> ■ Common mode interference voltage suppression: IEC 61298-3: Analog inputs: 80 dB at 60 V and 50 Hz / 60 Hz

- Push-pull interference voltage suppression: IEC 61298-3:
Analog inputs: 40 dB at 50 Hz / 60 Hz, for measuring range/10

Mechanical construction

Design, dimensions

See Installation

Weight

- Panel-mounted instrument, maximum configuration: approx. 2.7 kg (5.9 lb)
- Desk top housing, maximum configuration: approx. 4.4 kg (9.6 lb)
- Field housing (without unit): 4.07 kg (8.97 lb)

Materials

- Front light grey: GD-Z410 zinc diecasting (border area powder-coated)
- Front silver: GD-Z410 zinc diecasting industrial chromed
- Display panel (front): transparent plastic (Makrolon®)
- Flap (front): plastic (ABS UL94-V2)
- Membrane keypad: polyester (PC-ABS UL94-V2)
- Jog/shuttle dial ("navigator"): plastic (ABS UL94-V2)
- Intermediate frame (front to panel): plastic (PA6-GF15 UL94-V2)
- Casing: St 12 ZE (galvanized sheet steel)
- Rear panel: St 12 ZE (galvanized sheet steel)



All materials are free from silicone.

Desk top housing:

- Half shell housing: Sheet steel, electrolytic galvanized (powder-coated)
- Side profiles: extruded aluminum sheath (powder-coated)
- Profile ending: pigmented Polyamide
- Housing feet: pigmented Polyamide, glass fiber reinforced

Human interface

Display elements

Type:

Wide-screen TFT color graphic display

Size (Screen size):

178 mm (7")

Resolution:

Wide VGA 384,000 pixels (800 x 480 pixels)

Background illumination:

50,000 h half value time (= half brightness)

Number of colors:

262,000 viewable colors, 256 colors used

Viewing angle:

Max. viewing angle range: from the display central axis 50° in all directions

Screen display:

- Users can choose between black or white for the background color
- Active channels can be assigned to up to 10 groups. For the purposes of clear identification, these groups are given a name e.g. "Temperatures boiler 1" or "Daily average values of all boilers"

- Scales linear or logarithmic
- Replay function: rapid callup of history data with zoom function
- Preformatted screen display, such as horizontal or vertical curves, bar graphs, instrument display, circular chart or digital display, allow rapid and uncomplicated commissioning:

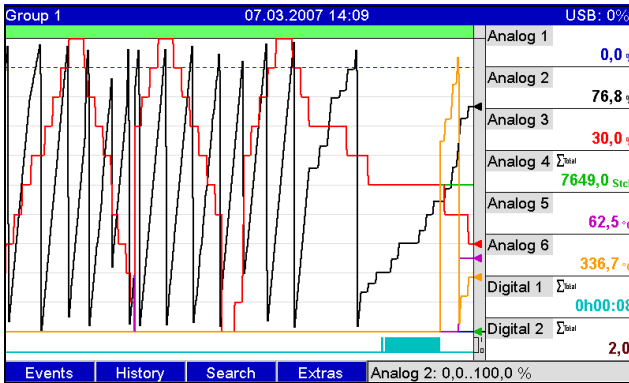

Curve display

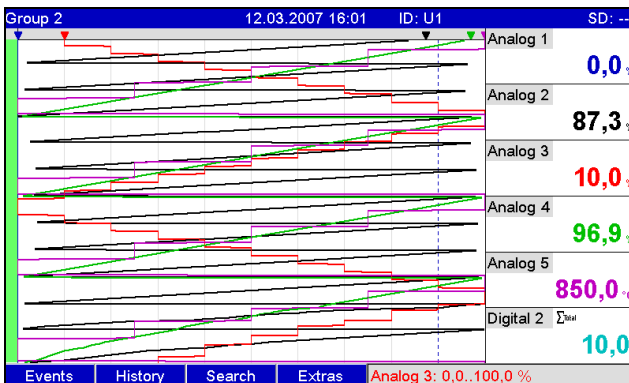

Waterfall

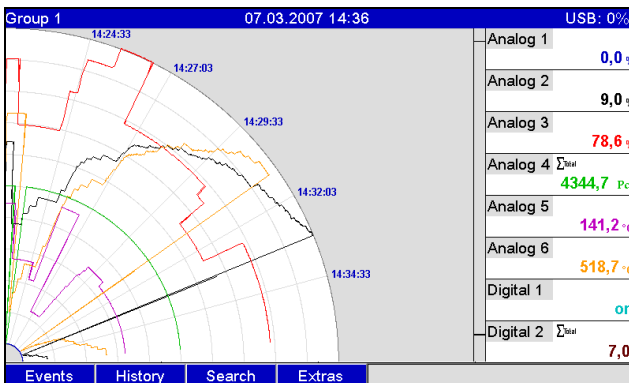

Circular chart

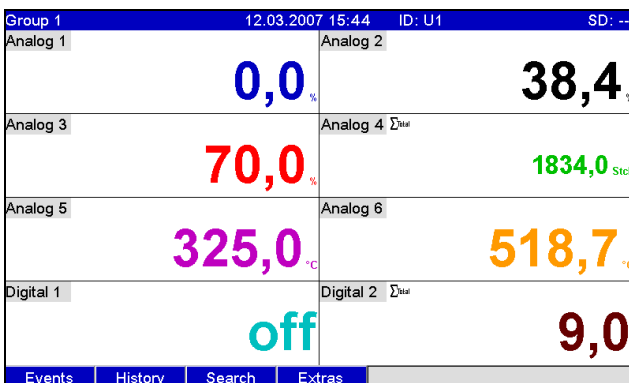

Digital display

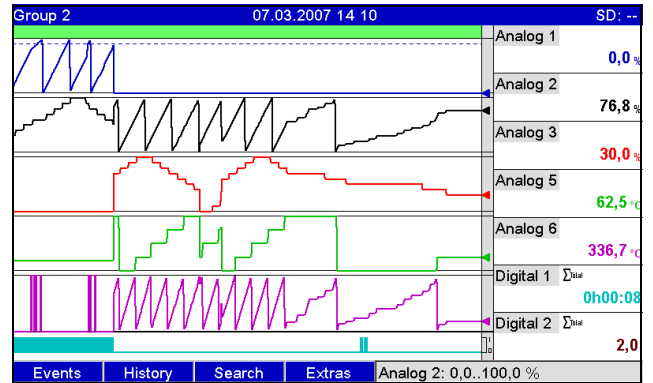

Curve in ranges

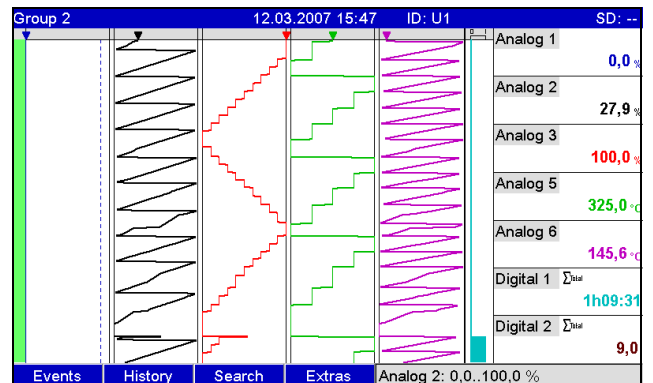

Waterfall in ranges

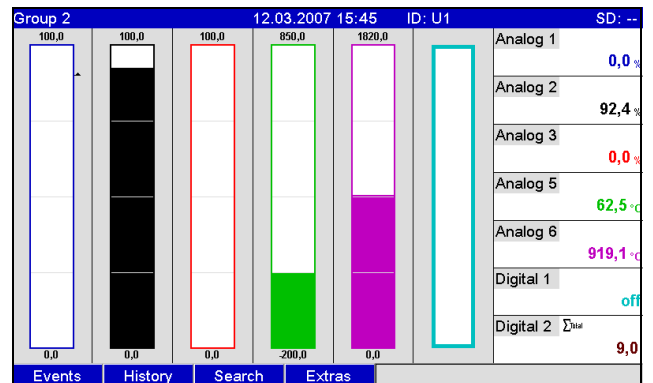

Bar graph

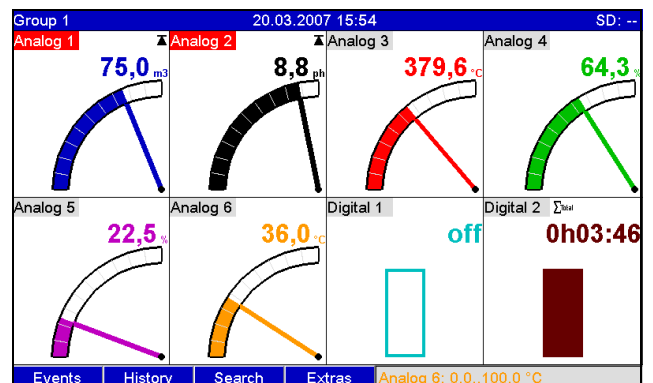

Instrument display

Event log / Audit Trail		08.03.2011 14:03	SD: --
Power on	08.03.2011 14:02:11	Digital 1	
Power off	08.03.2011 14:01:56		
No IP address could be obtained f...	08.03.2011 14:00:46		off
Power on	08.03.2011 13:50:46		
Power off	08.03.2011 13:50:37	Analog 1 Σ me	
Setup has been changed	08.03.2011 13:50:31		37,8%
Power on	08.03.2011 13:49:05		
Power off	08.03.2011 13:48:55		
Setup: Analog channel 2 changed.	08.03.2011 13:47:47	Analog 1 Σ me	
Setup has been changed	08.03.2011 13:47:47		7,8%
Power on	08.03.2011 13:45:39		
Power off	17.02.2011 15:39:54		
Setup: Application sett. changed.	17.02.2011 15:39:17	Digital 1	
Setup has been changed	17.02.2011 15:39:17		off
Power on	17.02.2011 15:37:45		
Power off	17.02.2011 15:36:45		

Event log

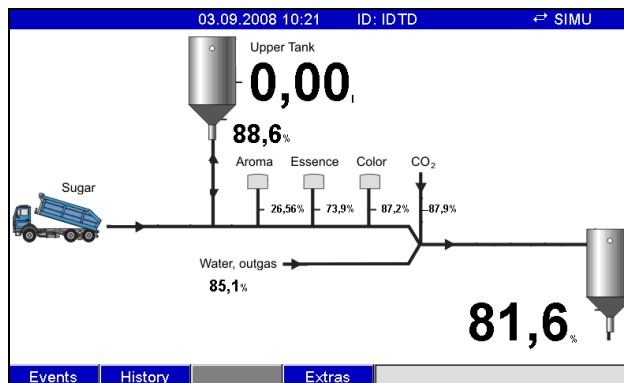

Process display

Operating elements

Unit keyboard:

Option of operation and configuration via navigator (jog/shuttle dial) and 4 softkeys on the front side in interactive dialog with the screen, or using PC software supplied. Integrated online help displayed at the press of a button.

External keyboard:

Additionally an external keyboard for operation and configuration can be connected to the equipment (USB type A "Host"). Radio keyboards are not supported.

Saving data

Memory cycle:

- Selectable memory cycle: off, 100ms, 1s / 2s / 3s / 4s / 5s / 10s / 15s / 20s / 30s / 1min / 2min / 3min / 4min / 5min / 10min / 15min / 30min / 1h
- High-speed saving (100ms) can be configured for up to 8 channels of group 1

Measured data storage, internal memory:

- Setup data memory, measured data memory and program memory: permanent backup of setup data and measured data in internal Flash memory with power failure protection (256 MB, nonvolatile)
- Data buffering and RTC buffering with lithium cell (buffering for 6 years; replace after 10 years).
- Even after being exported to a USB stick or SD card, measured data remain in the unit for a long time and can be reexported. This is important if the external data storage unit is lost or for official audits.
- Plant monitoring functions with operated hours counter, calibration monitoring, monitoring of storage medium exchange and other functions for monitoring the unit status.

External memory:

- Cyclic copy of the measured data for archiving on SD card (secure digital memory card)
- SD cards supported: 256 MB, 512 MB, 1 GB and 2 GB. Only use "Industrial Grade" SD cards (see Accessories).
- USB sticks supported: 256 MB, 512 MB, 1 GB and 2 GB. It cannot be ensured that USB sticks from all manufacturers will work perfectly. For this reason, an "Industrial Grade" SD card is recommended for safe data recording (see Accessories).
- A yellow LED beside the SD slot indicates data access. The SD card may not be removed while this LED is lit. Risk of losing data!

Typical recording length:

Prerequisites for following tables:

- No limit value violation/event storage
- Digital input not used
- Signal analysis deactivated



Frequent entries in the event log reduce the memory availability!

Internal memory 256 MB (weeks, days, hours):

Analog inputs	Memory cycle 5 min.	Memory cycle 1 min.	Memory cycle 30 s.	Memory cycle 10 s.	Memory cycle 1 s.
1	7211, 5, 16	1869, 5, 2	957, 4, 15	324, 3, 11	32, 3, 18
4	3169, 2, 5	718, 6, 20	363, 5, 5	121, 4, 1	12, 1, 9
12	1198, 3, 23	254, 6, 7	128, 2, 8	42, 6, 18	4, 2, 3
20	739, 0, 4	155, 2, 22	78, 0, 5	26, 0, 18	2, 4, 7

External SD card 254 MB (weeks, days, hours):

Analog inputs	Memory cycle 5 min.	Memory cycle 1 min.	Memory cycle 30 s.	Memory cycle 10 s.	Memory cycle 1 s.
1	9703, 3, 19	2515, 5, 3	1288, 3, 19	436, 4, 7	43, 5, 11
4	4264, 2, 8	967, 2, 18	489, 2, 22	163, 4, 3	16, 2, 21
12	1612, 4, 19	342, 6, 19	172, 4, 14	57, 5, 17	5, 5, 13
20	994, 2, 13	209, 0, 20	104, 6, 22	35, 0, 22	3, 3, 15

Calculating the recording duration:

The recording duration is calculated using the "storage calculator" (can be found in the "Tools" directory on the PC software CD-ROM supplied).

Pixels available for measured value curves:

Display method	Pixel
Curve display with instantaneous value display	566
Curve display without instantaneous value display	786
Waterfall	409
Circular chart	Not available



1 pixel = 1 measuring date
With 100 ms storage cycle -> 1 s = 10 pixels

Real time clock (RTC)

Configurable summer time/normal time automated system
Power reserve: buffering via lithium battery (buffering 6 years; replace after 10 years)
Deviation: <10 min./year
Time synchronization possible via PC software supplied or via control input.

Remote control, communication

- USB interface (front-panel), Ethernet interface and additional RS232/RS485 interface (rear)
- OPC server (3.0) for direct data exchange with databases or/and visualization systems
- Integrated Internet page (Web server) allows password-protected access to the device with every PC (e.g. for displaying the measured data)
- DHCP-enabled (dynamic allocation of an IP address)
- Device-internal summer time/winter time changeover

- Configuring and archiving the device settings with SD card, USB stick or with PC software supplied via rear-mounted serial interface RS232/RS485 (e.g. modem), Ethernet, or USB port.

Functions of the PC software supplied:

- Device configuration, measured data visualization, measured data administration and measured data export
- Export the measured data of individual channels to separate files or several channels to one file

Certificates and approvals

CE mark	The measuring system meets the legal requirements of the EC directives. The manufacturer confirms successful testing of the device by affixing the CE mark.
UL-listed for Canada and USA	The device has been examined by Underwriters Laboratories Inc. (UL) in compliance with the UL 61010-1 and CSA C22.2 No. 61010-1 standards and has been UL-listed under the number E225237.
Milk pasteurization approval	The device has been examined by the Technical University of Munich (TUM) in compliance with the test guidelines for measuring, control and safety devices for milk heating plants and has been listed under the number W-M1/07.
Electronic recording/ electronic signature	FDA 21 CFR11 The device meets the requirements of the "Food and Drug Administration" for electronic recording/ electronic signature.

Ordering information

Product structure	<p>Detailed ordering information is available from the following sources:</p> <ul style="list-style-type: none"> ▪ In the Product Configurator on the Endress+Hauser website: www.endress.com -> Select country -> Products -> Select device -> Product page function: Configure this product ▪ From your Endress+Hauser Sales Center: www.endress.com/worldwide <p> Product Configurator - the tool for individual product configuration:</p> <ul style="list-style-type: none"> ▪ Up-to-the-minute configuration data ▪ Depending on the device: Direct input of information specific to measuring point, such as measuring range or operating language ▪ Automatic verification of exclusion criteria ▪ Automatic creation of the order code and its breakdown in PDF or Excel output format ▪ Ability to order directly in the Endress+Hauser Online Shop
--------------------------	---

Accessories

Scope of delivery	<ul style="list-style-type: none"> ▪ Device (with terminals, as per your order) ▪ 2 fastening clips ▪ USB cable, length 1.5 m (4.9 ft) ▪ Optional secure digital (SD) card (card not in device but is supplied.) ▪ ReadWin 2000 PC operating and configuration software on CD-ROM ▪ Delivery note ▪ Multilanguage Brief Operating Instructions as hard copy
--------------------------	--

Anything missing? Then please inform your supplier.

In the case of the "Preset Application" option, the device is preset as required and the device configuration is supplied in hard copy.

In the case of the "Accuracy Calculation Application" option, a measurement uncertainty analysis is created in line with the application and supplied in hard copy. To carry out the calculation, the technical properties (measurement accuracy) of the sensors used must be communicated to Endress+Hauser.

Accessories

Various accessories, which can be ordered with the device or subsequently from Endress+Hauser, are available for the device. Detailed information on the order code in question is available from your local Endress+Hauser sales center or on the product page of the Endress+Hauser website:

www.endress.com/rsg40

The following accessories are available:

Order code	Accessory
71007465	Cable USB-A - USB-B, 2 m (6.6 ft)
71038635	"Industrial Grade" SD memory card 256 MB
71213190	"Industrial Grade" SD memory card 1 GB
RXU10-A1	RS232 cable set for connection with PC or modem, standard
RSG40A-S6	RS232/485 adapter set, DIN rail 230 VAC, with galvanic isolation + interface cable for PC/modem
RSG40A-S7	RS232/485 adapter set, DIN rail 115 VAC, with galvanic isolation + interface cable for PC/modem
RSG40A-H1	Field housing, IP65/NEMA 4x; Weight (without unit): 4.07 kg (8.97 lb)

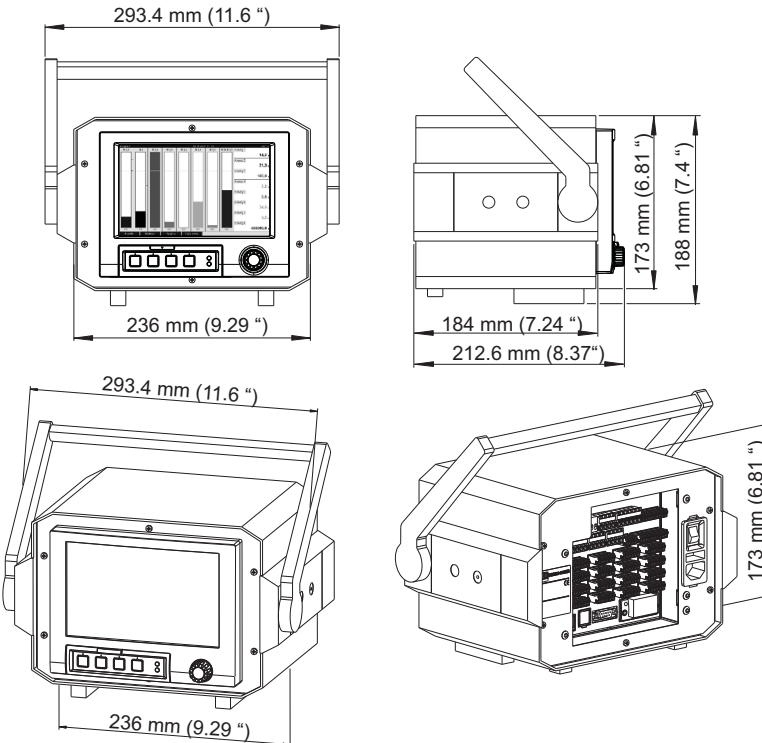
Order code	Accessory
RSG40X-	<p>Retrofit kit desk top version; Weight (maximum configuration): approx. 4.4 kg (9.6 lb) Cable + 2 pin european plug: RSG40X-HH Cable + norm swiss plug: RSG40X-HK Cable + US plug: RSG40X-HI</p> 
MS20-A1	"Field Data Manager" SQL based reporting software (1xWorkplace-Licence)

Documentation

- System Components and Data Managers brochure (FA00016K09en)
- Operating Instructions (BA00247R09en)
- Brief Operating Instructions (KA248R09)
- Operating Instructions Supplementary Description "PROFIBUS DP" (BA256R09)
- Operating Instructions Supplementary Description "Modbus RTU / TCP Slave" (BA00260R09)
- Operating Instructions Supplementary Description "Modbus RTU Master" (BA00301R09)
- Operating Instructions Supplementary Description "Überwachung von Milcherhitzeranlagen" (BA261R09de)
- Operating Instructions Supplementary Description "Energy, water+steam" (BA00266R09)
- Operating Instructions Supplementary Description "Batch software" (BA267R09)
- Operating Instructions Supplementary Description "Tele alarm" (BA268R09)
- Operating Instructions Supplementary Description "Waste water / storm water overflow tank (RÜB)" (BA269R09)

www.addresses.endress.com
