



Level



Pressure



Flow



Temperature



Liquid
Analysis



Registration



Systems
Components



Services



Solutions

Technical Information

Turbimax CUE25 / CUE26

Handheld turbidimeter for field measurement



Application

Turbimax CUE25 / CUE26 are compact handheld meters for the measurement of turbidity in the field. They are suitable for the following fields of application

- Drinking water
- Process water
- Wastewater

Your benefits

- Rugged carrying case containing everything needed
 - battery pack
 - calibration standards
 - manual
- Waterproof case provides use in any wet environment
- Versions with white light source and infrared light source available
- Auto ranging 0.01 to 1100 NTU / FNU
- Simple calibration procedures
- Reusable calibration standards
- Long-life batteries

Function and system design

Measuring principle

Turbidity measurement

For turbidity measurement a light beam is sent through the medium and is diverted from its original direction by optically denser particles, e.g. solid matter particles.

Measuring methods

90° WL scattered light method

The measurement uses the standardised 90° scattered light method acc. to U.S. EPA 180.1. The turbidity of the medium is determined by the amount of scattered light. The transmitted white light beam is scattered by the solid matter particles in the medium. The scattered beams are detected by scattered light receivers which are arranged at an angle of 90° to the white light source.

90° NIR scattered light method

The measurement uses the standardized 90° scattered light method acc. to ISO 7027 / EN 27027. The turbidity of the medium is determined by the amount of scattered light. The transmitted light beam with a wavelength in the near-infrared range is scattered by the solid matter particles in the medium. The scattered beams are detected by scattered light receivers which are arranged at an angle of 90° to the infrared light source.

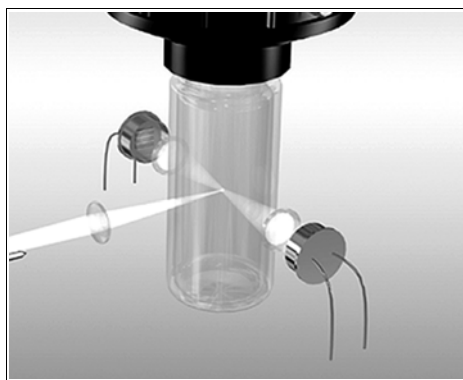

90° scattered light method

Functions

IR or white light measurement

The Turbimax is available as infrared version, CUE25, to meet the design criteria specified in ISO 7027 and DIN 27027. The white light version, CUE26, meets the design criteria on turbidity measurement specified by the US EPA 180.1. Both versions have long life lamps.

Auto ranging 0.01 to 1100 NTU

Turbimax CUE25/26 senses the turbidity level of a sample and automatically adjusts to the appropriate measuring range.

Simple calibration procedures

Calibration initiated with the push of a button ensures accurate readings.

Reusable calibration standards

The calibration standards allow quick and easy calibration across all ranges without the need to mix Formazin. The standards have a minimum shelf life of 12 months.

Measuring system

The measuring system comprises:

- Turbimax CUE25 / CUE26 turbidimeter
- Sample cuvette with light shield cap
- Indexing ring

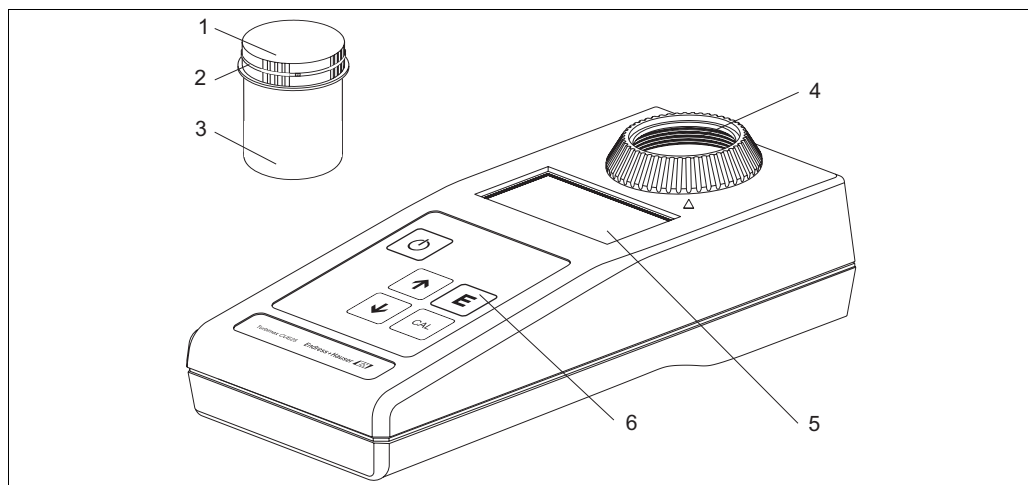

Turbimax CUE25 system (example)

- | | |
|---|--|
| <ul style="list-style-type: none"> 1 Black light shield 2 Indexing ring 3 Sample cuvette | <ul style="list-style-type: none"> 4 Optical well 5 Display 6 Touch pad |
|---|--|

Input

Measured variables	Turbidity
Measuring range	0.01 to 1100 NTU/FNU

Power supply

Batteries	4 AAA alkaline batteries (over 5000 tests)
Supply voltage	4 x 1.5 V

Performance characteristic

Response time	< 14 s
Reference temperature	25 °C (77 °F)
Resolution	0.01 NTU below 100 NTU 0.1 NTU in the range 100.0 to 999.9 NTU 1.0 NTU in the range 1000 to 1100 NTU
Maximum measured error	0 to 500 NTU: ±2 % of reading or 0.01 NTU 500 to 1100 NTU: ±3 % of reading
Repeatability	±2 % of reading

Environment

Ingress protection	IP 67 / NEMA 4x
Insulation rating	Pollution degree 2
Relative humidity	max. 90%, non-condensing

Process

Process temperature	0 to 50 °C / 32 to 122 °F
Medium temperature range	0 to 50 °C / 32 to 122 °F
Sample size	10 to 15 ml

Mechanical construction



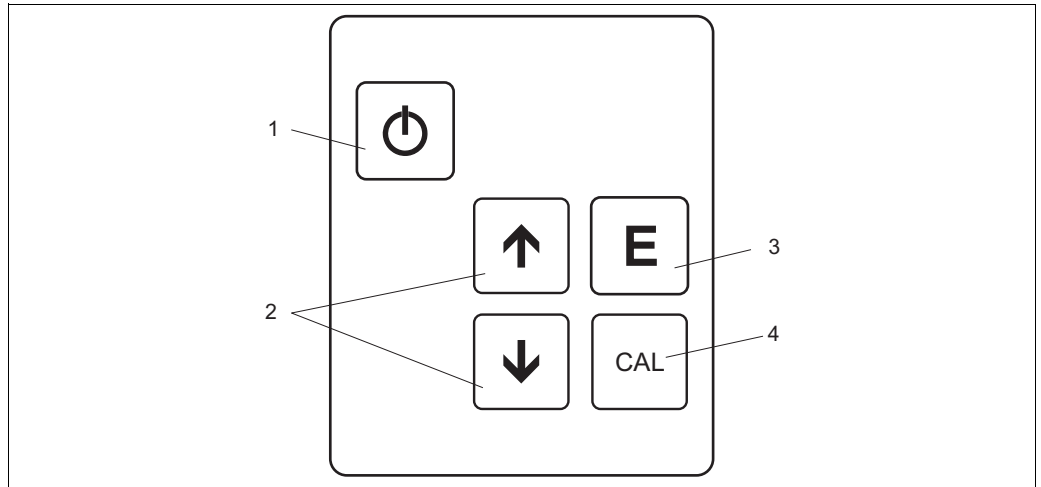

Dimensions	Instrument: H x W x L: 48 x 70 x 165 mm (1.875" x 2.75" x 6.50") Instrument in carry case H x W x L: 63 x 250 x 216 mm (2.50" x 10" x 8.50")	
Weight	1.2 kg (2.7 lbs.)	
Materials	Instrument housing:	ABS, injection molded
	Sample cuvette:	Borosilicate glass
	Carry case:	High density polyethylene blow molded
Light source	Turbimax CUE25:	Infrared LED, 860 nm
	Turbimax CUE26:	Tungsten lamp, ~600 nm, 2250 °K

Human interface

Operating elements



Operating elements

- 1  key used to turn the Turbimax on or off
- 2  keys used to set numerical values and to scroll through the list
- 3  key used to index a sample when pressed and held and to start a reading or calibration when released
- 4  key used to enter or exit calibration mode

Display

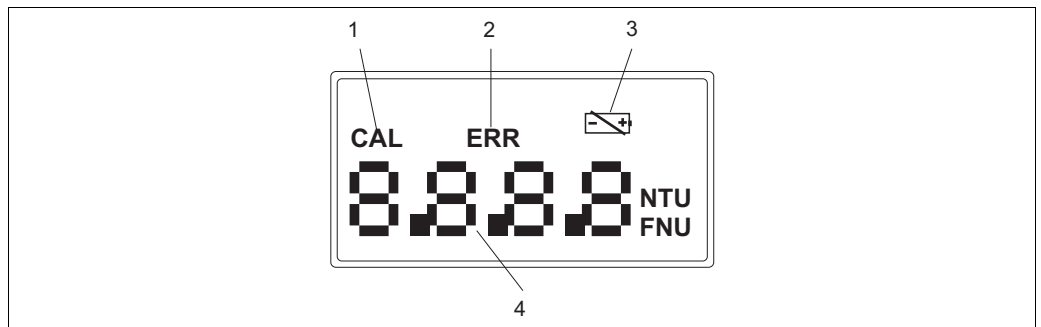

Display

- 1 *Icon indicating calibration mode*
- 2 *Icon indicating error conditions*
- 3 *Icon indicating low battery*
- 4 *Display of turbidity levels and user guidance in calibration routine*

Certificates and approvals

CE symbol

Declaration of conformity

The product meets the legal requirements of the harmonized European standards.
The manufacturer confirms compliance with the standards by affixing the **CE** symbol.

EMC compatibility

Interference emission and interference immunity complies with EN 61326: 1997 / A1: 1998

Ordering information

CUE25 handheld, infrared

		Version
	A	Standard
CUE25-		complete order code

CUE26 handheld, white light

		Version
	A	Standard
CUE26-		complete order code

Scope of delivery

The scope of delivery comprises:

- 1 Turbimax CUE25 /CUE26 turbidimeter with 4 AAA alkaline batteries
- 1 Calibration kit CUE25 / CUE26 including
 - 0.02 NTU standard
 - 10.0 NTU standard
 - 1000 NTU standard
- 2 Empty cuvettes and Kimwipes®
- 1 Operating Instructions BA397C/07/en
- 1 Instruction card

Accessories

Calibration standards

Calibration kit CUE25 / CUE26, full range

- 0.02 NTU
- 10.0 NTU
- 1000 NTU

Order no.: 51518582

Cuvettes

- Sample cuvettes CUE25 / CUE26
incl. caps, 3 pcs.
Order no.: 51518583

International Headquarters

Endress+Hauser
GmbH+Co. KG
Instruments International
Colmarer Str. 6
79576 Weil am Rhein
Deutschland

Tel. +49 76 21 9 75 02
Fax +49 76 21 9 75 34 5
www.endress.com
info@ii.endress.com

TI397C/07/en/07.06
71001156
Printed in Germany / FM+SGML 6.0 / DT

Endress+Hauser 
People for Process Automation