



Level



Pressure



Flow



Temperature

Liquid
Analysis

Registration

Systems
Components

Services



Solutions

Technical Information

Omnigrad S TMT142C

Compact Thermometer

Temperature transmitter for thermocouples, adjustable via HART® protocol



Application

The temperature assembly TMT142C from the Omnigrad S family is a compact thermometer specifically designed to fulfill the requirements of different process industries such as the chemical, petrochemical and energy but even suitable to other general purpose applications.

The thermometer assembly TMT142C consists of a thermocouple sensor insert (Type J or K) and an electronic two-wire temperature transmitter providing a 4 to 20 mA output, configurable via HART® protocol. Thanks to the versatility of its product structure, the TMT142C is easily adaptable to various applications in many different industrial processes.

Your benefits

- HART® protocol for operating the device on site using handheld terminal (DXR375) or remotely via the PC
- Illuminated display, rotatable
- Operation, visualization and maintenance with PC, e.g. using FieldCare or ReadWin® 2000 operating software
- 2-wire transmitter, analog output 4 to 20 mA
- Undervoltage detection responds immediately, output of falsified measured values is prevented
- Highly accurate in entire operating temperature range

- Sensor monitoring:
 - Failure conditioning, corrosion detection to NAMUR NE 89; Failure conditioning in event of sensor break or sensor short-circuit, adjustable to NAMUR NE 43
- EMC to NAMUR NE 21, CE
- Sensor insets with thermocouple (Type J or K) made by mineraloxide cables, replaceable
- Thermocouple sensing element type J or K, accuracy class 1 or 2 (IEC 60584)
- Single or double TC element
- Aluminum or Stainless steel (optional) housing with ingress protection degree IP67 or NEMA 4x
- Calibration certificate can be ordered in the product structure
- Output simulation
- Min./max. process value recorded
- Customized measuring range setup or expanded SETUP, see questionnaire
- Approvals: ATEX (EEx ia, EEx d and Staub-Ex), CSA (IS, NI, XP and DIP)

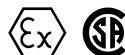

Function and system design

Measuring principle

In the thermocouple thermometer the sensing element is created by the physical junction of two homogeneous but different alloys (wires) isolated for the entire length, except in the junction point. The two wires are welded on one side, named 'measuring or hot junction', while the free wires side, named 'reference or cold junction' is connected to an electrical circuit measuring the electromotive force (mVolts) generated by the different thermoelectric characteristics of the two thermocouple wires when a temperature difference between the hot junction (T1) and the cold junction (T0) occurs. The function linking the electromotive force to the temperatures T1 and T0 depends on the materials utilized in the alloys. These functions are standardized curves, for different alloys couples, by the following international standards: IEC 60584 and ANSI MC96.1.

Measuring system

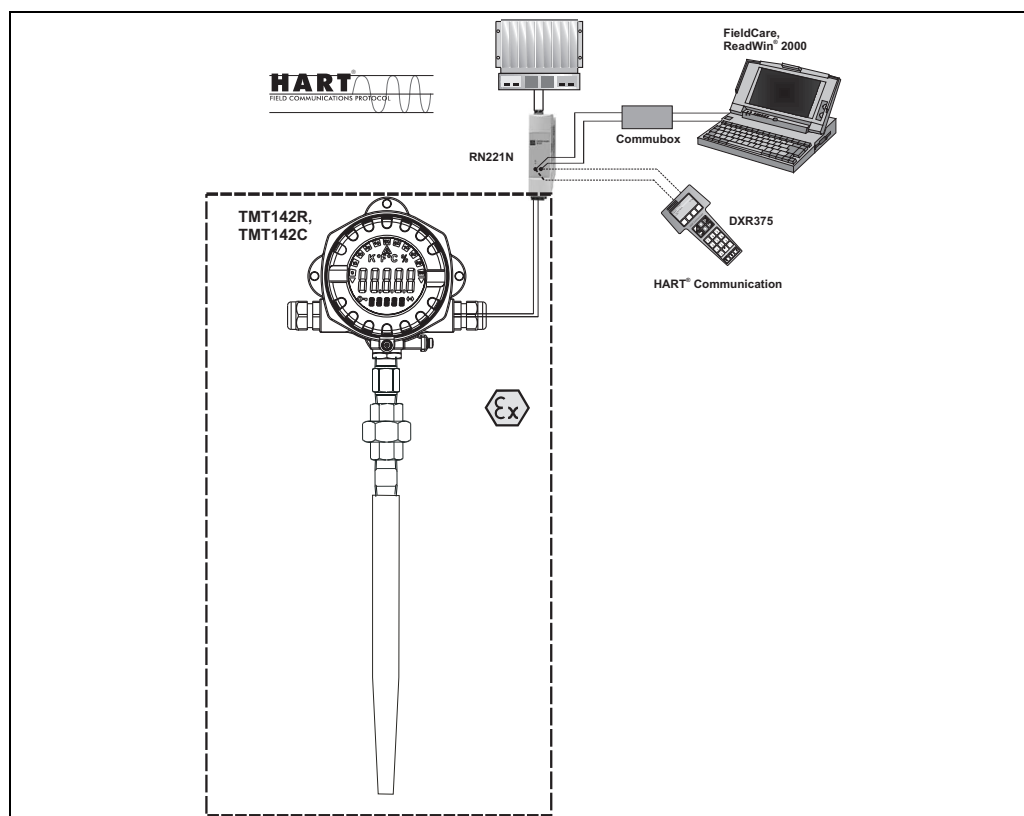

Example of an application of the compact thermometer

The Omnigrad S HART® TMT142C is a compact thermometer with a two-wire transmitter and an input for thermocouples (Type J or K) and an analog output. The LC display shows the current measured value digitally and as a bar graph with an indicator for limit value violation. The TMT142C can be operated via the HART® protocol using a handheld terminal (DXR375) or PC (FieldCare or ReadWin® 2000 operating software). The sensor construction is based on the IEC 60751 standard, giving high reliability and performance in all the typical industrial environment conditions.

The TC sensing elements are created by two types of alloy couples: the type J (Fe-CuNi) or the type K (NiCr-Ni). The measuring ranges of this temperature sensing elements have different values depending on the couple types. The measuring probe (TC replaceable insert) is installed in a suitable thermowell.

Thanks to the spring load construction method, the thermometer insert stays always in contact with the inner tip of the thermowell in order to guarantee the best heating transfer from the process to the sensing element. The transmitter housing is available either in coated aluminum or stainless steel (optional), with or without LC display. The fit between housing, thermowell and cable gland ensures a minimum IP65 (Ingress Protection) grade.

The thermowell can be either welded or made from bar-stock material. The thermowells are available in different forms and with many process connections: threads, flanges or weld-in types (see the paragraph "Thermowell").

Corrosion detection

Sensor connection line corrosion can corrupt the measured value. For this reason, the device gives you the opportunity to detect corrosion for thermocouples and resistance thermometers with a 4-wire connection before measured value corruption takes place.

Input

Measured variable Temperature (temperature linear transmission behavior)

Measuring range The transmitter records different measuring ranges depending on the sensor connection and input signals (see 'Type of input').

Type of input

Input	Designation	Measuring range limits	Min. span
Thermocouples (TC) to NIST Monograph 175, IEC 584	Type J (Fe-CuNi)	-210 to +1200 °C (-346 to 2192 °F)	50 K
	Type K (NiCr-Ni)	-270 to +1372 °C (-454 to 2501 °F)	50 K
<ul style="list-style-type: none"> ■ Internal cold junction (Pt100) ■ Accuracy of cold junction: ± 1 K ■ Max. sensor resistance 10 kΩ (if sensor resistance is greater than 10 kΩ, error message as per NAMUR NE 89) 			

Response time Tests in water at 0.4 m/s (according to IEC 60751; 23 to 33°C step changes), without thermowell:

- t₅₀: 2.5 s
- t₉₀: 7 s

Self heating Negligible

Output

Output signal analog 4 to 20 mA, 20 to 4 mA

Signal on alarm

- Underranging:
Linear drop to 3.8 mA
- Overranging:
Linear rise to 20.5 mA

Load max. $(V_{\text{power supply}} - 11 \text{ V}) / 0.022 \text{ A}$ (current output)

Linearization/transmission behavior Temperature linear, resistance linear, voltage linear

Filter 1st order digital filter: 0 to 60 s

Galvanic isolation U = 2 kV AC (input/output)

Input current required ≤ 3.5 mA

Current limit ≤ 23 mA

Switch-on delay 4 s (during switch-on operation I_a = 4 mA)

Power supply

Electrical connection

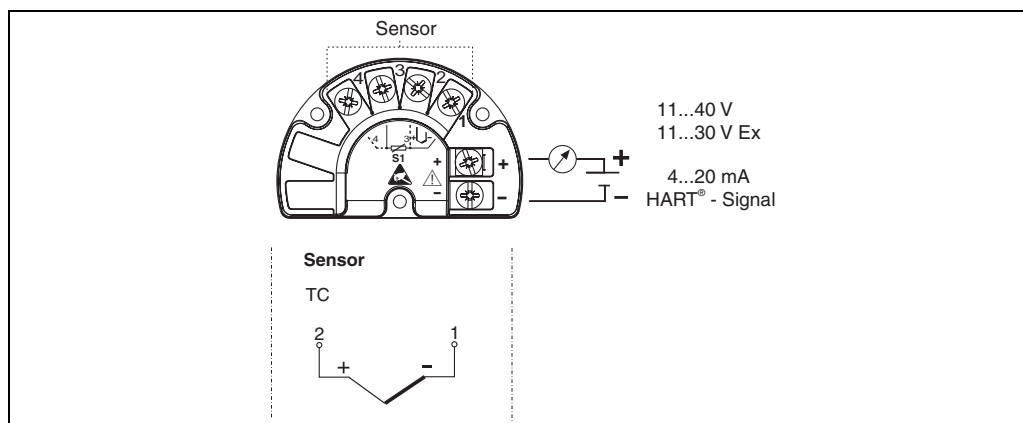

Supply voltage

$U_b = 11$ to 40 V (8 to 40 V without display), reverse polarity protection

Warning!

Power must be fed to the device from an 11 to 40 VDC power supply in accordance with NEC Class 02 (low voltage/current) with short-circuit power limit to 8 A/150 VA.

Cable entry

see "Product structure"

Residual ripple

Perm. residual ripple $U_{ss} \leq 3$ V at $U_b \geq 13.5$ V, $f_{max.} = 1$ kHz

Accuracy

Response time

1 s per channel

Reference operating conditions

Calibration temperature: $+25$ °C \pm 5 K (77 °F \pm 9 °F)

Maximum measured error

The accuracy values defined by the IEC 60584 standard, are as follows:

Type	Standard tolerance (IEC 60584)		Reduced tolerance (IEC 60584)	
	Class	Deviation	Class	Deviation
J (Fe-CuNi)	2	± 2.5 °C (-40...333 °C) ± 0.0075 t (333...750 °C)	1	± 1.5 °C (-40...375 °C) ± 0.004 t (375...750 °C)
K (NiCr-Ni)	2	± 2.5 °C (-40...333 °C) ± 0.0075 t (333...1200 °C)	1	± 1.5 °C (-40...375 °C) ± 0.004 t (375...1000 °C)

(|t|=absolute temperature value in °C)

Transmitter maximum measured error

	Designation	Accuracy		
		digital	D/A ¹	
Thermocouples (TC)	K, J	typ. 0.5 K	typ. 0.25 K ²	0.02%

1) % relates to the set span. Accuracy = digital + D/A accuracy

2) Only with the "Advanced Electronics" option

Physical input range of the sensors

-20 to 100 mV	Thermocouples type: J, K
---------------	--------------------------

Repeatability

0.03% of the physical input range (15 Bit)
Resolution A/D conversion: 18 Bit

With the "Advanced Electronics" option:

0.015% of the physical input range (16 Bit)

Influence of supply voltage

$\leq \pm 0.005\%/V$ deviation from 24 V, related to the full scale value

Long-term stability

≤ 0.1 K/year or $\leq 0.05\%/year$
Data under reference conditions. % relates to the set span. The larger value applies.

Influence of ambient temperature (temperature drift) Total temperature drift = input temperature drift + output temperature drift

Effect on the accuracy when ambient temperature changes by 1 K (1.8 °F)		
Input 10 to 400 Ω	0.002% of measured value	0.001% of measured value ¹
Input 10 to 2000 Ω	0.002% of measured value	0.001% of measured value ¹
Input -20 to 100 mV	typ. 0.002% of measured value (maximum value = 1.5 x typ.)	typ. 0.001% of measured value ¹ (maximum value = 1.5 x typ.)
Input -5 to 30 mV	typ. 0.002% of measured value (maximum value = 1.5 x typ.)	typ. 0.001% of measured value ¹ (maximum value = 1.5 x typ.)
Output 4 bis 20 mA	typ. 0.002% of measured value (maximum value = 1.5 x typ.)	typ. 0.001% of span ¹ (maximum value = 1.5 x typ.)

1) Only with the "Advanced Electronics" option

Typical sensor resistance change when process temperature changes by 1 K (1.8 °F):
J: 55 μV
K: 40 μV

Examples for calculating the accuracy:

■ Example 1 (without the "Advanced Electronics" option):

Input temperature drift $\Delta\theta = 10$ K (18 °F), thermocouple type K with span 0 to 600 °C (32 to 1112 °F)

Maximum process value: 600 °C (1112 °F)

Measured thermoelectric voltage: 24905 μV (see IEC584)

Typ. influence in μV: (0.002% of 24905 μV) * 10 = 5 μV

Conversion Ω to °C: 5 μV / 40 μV/K = 0.12 K (0.216 °F)

■ Example 2 (without the "Advanced Electronics" option):

Output temperature drift $\Delta\theta = 10$ K (18 °F), measuring range 0 to 100 °C (32 to 212 °F)

Span: 100 K (180 °F)

Typical influence: (0.002% of 100 K) * 10 = 0.02 K; (0.002% of 180 °F) * 10 = 0.036 °F

$\Delta\theta$ = deviation of ambient temperature from the reference operating condition

Total measuring point error = max. possible measured error + temperature sensor error

Influence of cold junction Pt100 DIN IEC 751 Cl. B (internal cold junction with thermocouples TC)

Installation

Installation instructions

Mounting location

Direct mounting on the temperature sensor or indirect mounting using mounting bracket (see 'Accessories').

Environment

Ambient temperature limits	<ul style="list-style-type: none"> ■ without display: -40 to +85 °C (-40 °F to +185 °F) ■ with display: -40 to +70 °C (-40 °F to +158 °F) <p>For use in hazardous areas, see Ex certificate</p> <p>Note! The display can react slowly for temperatures < -20 °C (< -4 °F). Readability of the display cannot be guaranteed at temperatures < -30 °C (-22 °F).</p>
Process temperature	The operating range depends on sensor and thermowell.
Storage temperature	<ul style="list-style-type: none"> ■ Without display: -40 to +100 °C (-40 °F to +212 °F) ■ with display: -40 to +85 °C (-40 °F to +185 °F)
Operating height	Up to 2000 m above MSL
Climate class	As per IEC 60 654-1, Class C
Degree of protection	IP 67, NEMA 4x
Shock and vibration resistance	3g / 2 to 150 Hz as per IEC 60 068-2-6
Electromagnetic compatibility (EMC)	Interference immunity and interference emission as per EN 61 326-1 (IEC 1326) and NAMUR NE 210.08 to 2 GHz 10 V/m; 1.4 to 2 GHz 30 V/m to EN 61000-4-3
Condensation	Permitted
Installation category	I
Pollution degree	2
Maximum process pressure	Maximum pressure values at various temperatures are indicated in the Technical Information of the different thermowells (see TI documentation codes at the end of this document).
Maximum flow velocity	The maximum flow velocity depends on the insertion length, the mechanical strength of the thermowell, and on pressure and temperature of the measuring point.

Mechanical construction

Installation

The Omnigrad S resistance thermometer model TMT142C can be mounted on the wall of pipes or vessels or other plant parts. In the case of ATEX/FM/CSA certified components (transmitter + insert), please refer to the relevant documentation (see "Documentation").

The immersion length may have an effect on the accuracy of the measurement. If the immersion is too small, an error may be generated in the temperature detected due to the lower temperature of the process fluid near to the walls and the heat transfer, which takes place through the sensor shaft. The incidence of such an error is not negligible if there is a big difference between the process temperature and the ambient temperature. In order to avoid this source of inaccuracy, the thermowell should have a small diameter and the immersion length (L) should be, if possible, at least 100-150 mm.

In pipes of a small cross-section the axis line of the duct must be reached and if possible slightly exceeded by the tip of the thermowell (refer to fig. A and C). Another solution may be a tilted installation (see fig. Band D).

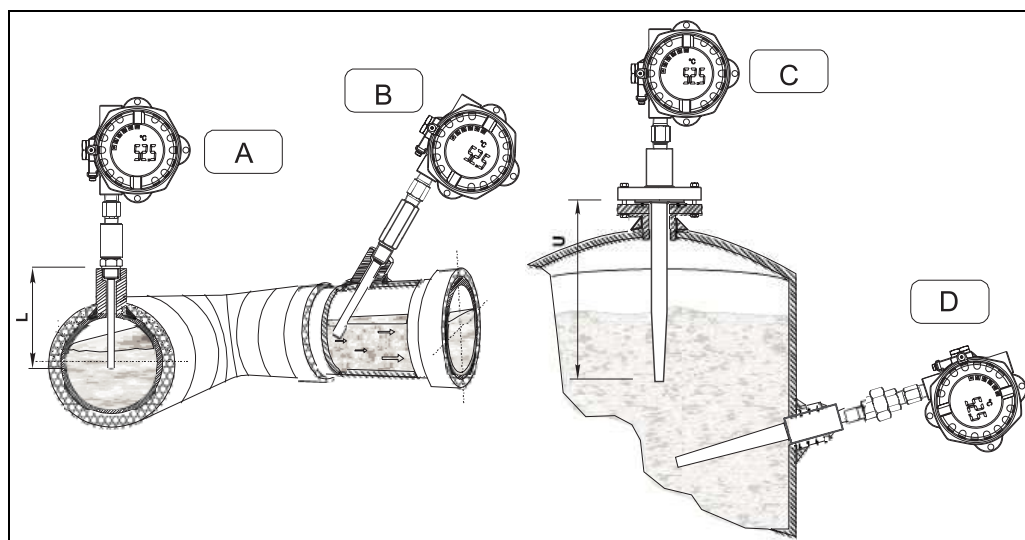

Examples of installation

In the case of two-phase flows, please pay special attention to the choice of the measurement point, as there may be fluctuations in the value of the detected temperature. With regard to corrosion, the base material of the wetted thermowells is important.

In case that the sensor components are disassembled and then re-mounted the proper assembling torque must be applied in order to guarantee the defined ingress protection.

Housing

The housing of the TMT142C is a single compartment container.

Microcontroller controlled display in single chamber housing with illuminated LC display. Parameterization of measuring range, decimal point and offset of the display can be done comfortably using a PC with the PC software ReadWin® 2000. The display is continuously rear-illuminated and does not require additional wiring for power supply.

Extension neck







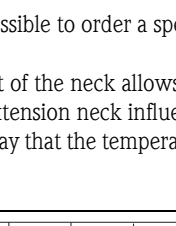

The function of the extension neck between the sensor and the transmitter (electronic with display) is to protect the transmitter from overheating due to high process temperatures.

The extension neck consists of various couplings (nipples, union) suitable to adapt the temperature sensor to the different thermowells.

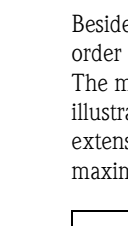
The neck material is usually stainless steel 316L/1.4404.

The standard lengths (N) and the extension neck versions are selectable amongst the following options:

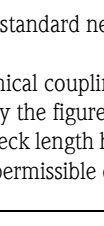
- 52 mm (2.05") (only 1/2" NPT, Type L)
- 102 mm (4.02") (nipple+union, Type LU)
- 96 mm (3.78") (nipple+coupling, Type LC)
- 144 mm (5.67") (nipple+union+nipple, Type LUN)
- 138 mm (5.43") (nipple+coupling+nipple, Type LCN)

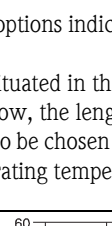
Process connection to thermowell: threads					
Type	Thread	Digit	C (mm)	Detail	Extension neck type
Male	G 1/2"	D	15		 
	1/2" NPT	N	8		  
	3/4" NPT	P	8.5		
Female	1/2" NPT	U	8		 
	M24x1.5	5	16		

Caution!

* Extension necks available only with 1/2" NPT threads

Besides the standard neck options indicated it is possible to order a specific neck by entering the length in the order code.

The mechanical coupling situated in the upper part of the neck allows for orientation of the sensor head. As illustrated by the figure below, the length of the extension neck influences the temperature in the head. The extension neck length has to be chosen in such a way that the temperature within the head remains below the maximum permissible operating temperature.

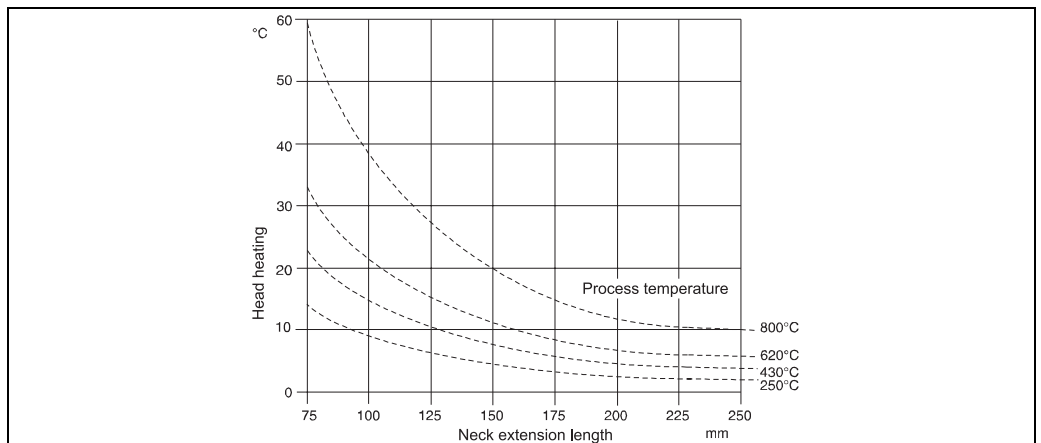

Heating of the head due to the process temperature

Thermowell

The thermowell already exists in the plant or has to be ordered separately. To this end the extension neck is available with different forms. In order to easily select the right mechanical fitting for the thermowell you are kindly requested to use the table list and the ML values described at the chapter "Probe".

Probe

In the TMT142C compact thermometer the probe consists of a mineral oxide insert which is inserted and fixed into the thermowell.

The length of the sensor is freely selectable inside the predefined lengths range (50 to 990 mm / 1.97" to 39"). Sensors exceeding the 990 mm (39") length are available on request.

The immersion length (ML) must be defined as a function of the type and length of the relevant thermowell. In case of spare inserts to be ordered please read carefully the following table (table valid for standard thickness tip):

Thermowell type	ML	Thermowell type	ML	Thermowell type	ML
TW10*	ML = A - 8	TA535	ML = A - 8	TA560	ML = A - 11
TW11*	ML = A - 8			TA562	ML = A - 11
TW12*	ML = A - 8	TA540	ML = A - 10	TA565	ML = A - 11
TW13*	ML = A - 8	TA541*	ML = A - 10	TA566	ML = A - 11
TW10**	ML = A - 15			TA570	ML = A - 11
TW11**	ML = A - 15	TA550	ML = A - 11	TA571	ML = A - 11
TW12**	ML = A - 15	TA555	ML = A - 10	TA572	ML = A - 11
TW13**	ML = A - 15	TA556	ML = A - 10	TA575	ML = A - 11
TW15**	TW15**	TA557	ML = A - 10	TA576	ML = A - 10

Caution!

* TMT142C with connection to thermowell NPT female

** TMT142C with connection to thermowell metric female (M24x1.5)

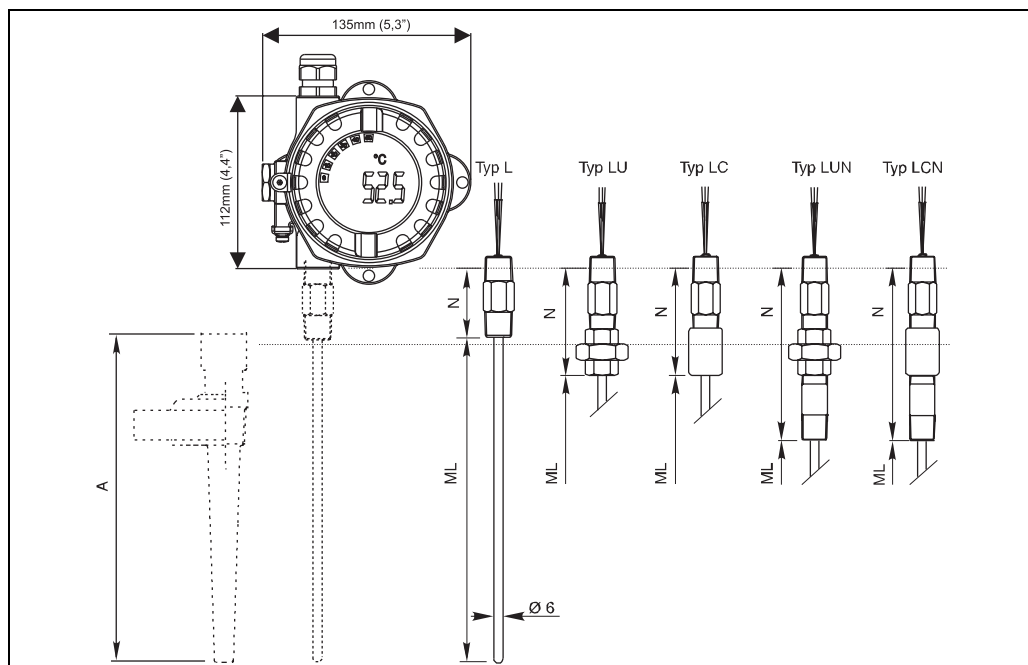

System components

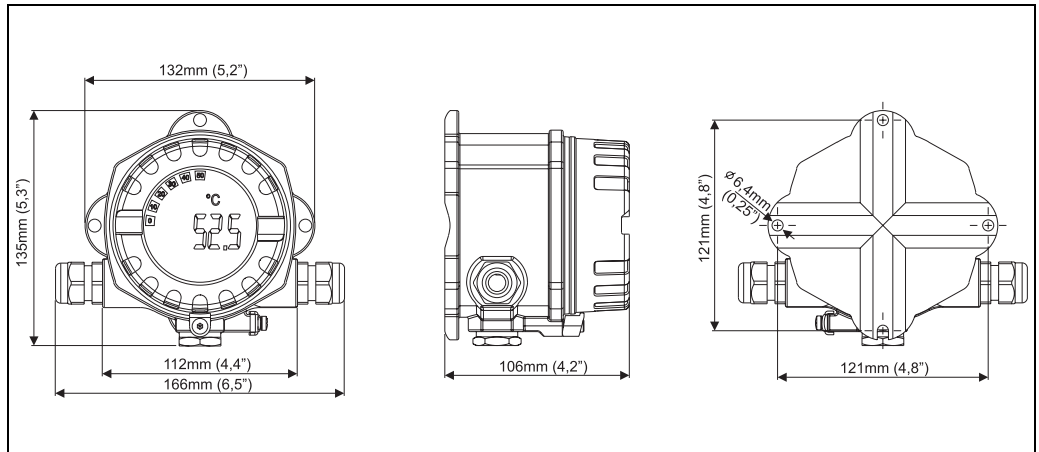
Design, dimensions of the connection head

Data in mm (data in Inches in brackets)

- Display rotatable in 90° stages

Weight

- 1.6 kg to 5 kg (3.5 to 11 lbs) (standard options with aluminum housing)
- 4.2 kg to 8 kg (9.4 to 17.6 lbs) (standard options with stainless steel housing)

Material

- Housing: die-cast aluminium housing AlSi10Mg with powder coating on polyester basis or stainless steel 1.4435 (AISI 316L)
- Sheathing: 1.4404 (AISI 316L)
- Nameplate: 1.4301 (AISI 304)

Terminals

Cables / wires up to max. 2.5 mm² (AWG 13) plus ferrule

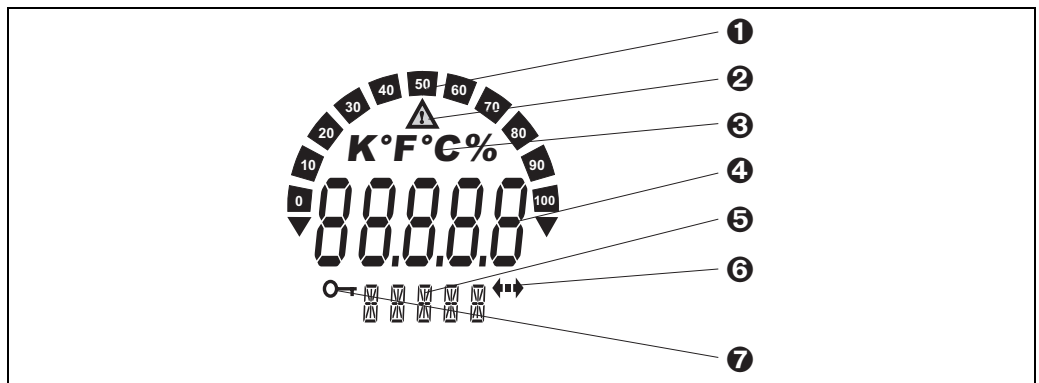
Human interface**Display elements**

LC display of the field transmitter (illuminated, can be rotated in 90 stages)

Item 1: Bar graph display in 0 % stages with indicators for overranging/underranging

Item 2: 'Caution' display

Item 3: Unit display K, °F, °C or %

Item 4: Measured value display (digit height 20.5 mm / 0.81 ")

Item 5: Status and information display

Item 6: 'Communication' display

Item 7: 'Programming disabled' display

Operating elements

No operating elements are present directly on the display. The device parameters of the field transmitter are configured using the DXR375 handheld terminal or a PC with Commubox FXA191 and operating software (e.g. FieldCare or ReadWin® 2000).

Remote operation**Configuration**

see 'Operating elements'

Interface

HART® communication via transmitter power supply (e.g. RN221N; see 'Measuring system').

Configurable device parameters (selection)

Sensor type and type of connection, engineering units (°C/°F), measuring ranges, internal/external cold junction, compensation of wire resistance with 2-wire connection, failure mode, output signal (4 to 20/20 to 4 mA), digital filter (damping), offset, TAG+descriptor (8+16 characters), output simulation, customized linearization, recording of min./max. process value, analog output: channel 1 (C1)

Option: customized linearization

Certificates and approvals

CE mark

The device meets the statutory requirements of the EC directives. Endress+Hauser confirms successful testing of the device by affixing to it the CE mark.

Ex approval

Information about currently available Ex versions (ATEX, FM, CSA, etc.) can be supplied by your E+H Sales Center on request. All explosion protection data are given in a separate documentation which is available upon request.

Other standards and guidelines

- IEC 60529:
Degrees of protection through housing (IP code)
- IEC 61010:
Protection measures for electrical equipment for measurement, control, regulation and laboratory procedures
- IEC 1326:
Electromagnetic compatibility (EMC requirements)
- NAMUR
Association for Standards for Control and Regulation in the Chemical Industry

Ordering information

Questionnaire

Questionnaire Endress+Hauser iTEMP temperature transmitter Customer specific setup / Kundenspezifische Einstellung			
Standard setup / Standardeinstellung			
Sensor 1 (S1)			
TC	<input type="checkbox"/> B <input type="checkbox"/> C <input type="checkbox"/> D <input type="checkbox"/> E <input type="checkbox"/> J <input type="checkbox"/> K <input type="checkbox"/> L <input type="checkbox"/> N <input type="checkbox"/> R <input type="checkbox"/> S <input type="checkbox"/> T <input type="checkbox"/> U		
RTD	<input type="checkbox"/> Pt100 <input type="checkbox"/> Pt500 <input type="checkbox"/> Pt1000 <input type="checkbox"/> Ni100 <input type="checkbox"/> Ni500 <input type="checkbox"/> Ni1000		
<input type="checkbox"/> mV <input type="checkbox"/> 10...400 Ohm <input type="checkbox"/> 10...2000 Ohm			
<input type="checkbox"/> 2 wire <input type="checkbox"/> 3 wire <input type="checkbox"/> 4 wire			
Unit / Einheit <input type="checkbox"/> °C <input type="checkbox"/> °F <input type="checkbox"/> K <input type="checkbox"/> °R <input type="checkbox"/> mV <input type="checkbox"/> Ohm			
Range / Messbereich <small>(not / nicht PROFIBUS-PA)</small>	Low scale Anfang	<input type="text"/> <input type="text"/> <input type="text"/> <input type="text"/> <input type="text"/> <input type="text"/> , <input type="text"/>	Bitte beachten! Messbereich und min. Spanne (s. Techn. Daten)
	High scale Ende	<input type="text"/> <input type="text"/> <input type="text"/> <input type="text"/> <input type="text"/> <input type="text"/> , <input type="text"/>	Note! Range and min. span (s. Techn. data)
Bus address / Busadresse <small>(only / nur PROFIBUS-PA)</small>		<input type="text"/> <input type="text"/> <input type="text"/>	[0...126]
Expanded setup / Erweiterte Einstellung			
Reference junction / Vergleichsstelle	<input type="checkbox"/> intern	<input type="checkbox"/> extern	<small>(only / nur TC)</small>
		<input type="text"/> <input type="text"/> <input type="text"/>	[0...80°C; 32...176°F]
Compensation wire resistance / Kompensation Leitungswiderstand	S1	<input type="text"/> <input type="text"/>	[0...30 Ohm] <small>(only / nur RTD 2 wire)</small>
Failure mode / Fehlverhalten	<input type="checkbox"/> ≤ 3,6 mA	<input type="checkbox"/> ≥ 21,0 mA	<small>(not / nicht PROFIBUS-PA)</small>
Output / Ausgang	<input type="checkbox"/> 4...20 mA	<input type="checkbox"/> 20...4 mA	<small>(not / nicht PROFIBUS-PA)</small>
Filter	<input type="text"/> <input type="text"/>		[0, 1, 2,..., 60s]
Offset	S1	<input type="text"/> <input type="text"/> , <input type="text"/>	[-10... 0...+10 K/-18...0...+18 °F]
Line voltage filter/Netzspannungsfiler <input type="checkbox"/> 50 Hz <input type="checkbox"/> 60 Hz			
TAG			
<input type="text"/> <input type="text"/> <input type="text"/> <input type="text"/> <input type="text"/> <input type="text"/> <input type="text"/> <input type="text"/>			
<small>(8 char. TAG + 16 char. Descriptor)</small>			
DESCRIPTOR			
<input type="text"/> <input type="text"/> <input type="text"/> <input type="text"/> <input type="text"/> <input type="text"/> <input type="text"/> <input type="text"/> <input type="text"/> <input type="text"/> <input type="text"/> <input type="text"/> <input type="text"/> <input type="text"/> <input type="text"/> <input type="text"/> <input type="text"/> <input type="text"/> <input type="text"/> <input type="text"/> <input type="text"/>			
Endress+Hauser			
<small>People for Process Automation</small>			

Product structure

TMT142C	Omnigrad S TMT142C TC Thermometer			
	Approval			
	A	Non-hazardous area		
	B	ATEX II1G EEx ia IIC T4/T5/T6		
	D	CSA IS, NI I/1+2/A-D		
	E	ATEX II2GD EEx d IIC T6		
	G	CSA XP, DIP I,II,III/1+2/A-D		
	H	ATEX EEx d EEx ia		
	K	CSA XP, DIP, IS, NI, I, II, III/1+2/A-D		
	L	ATEX II 3G EEx nA IIC T4/T5/T6		
	M	ATEX II 1/2GD EEx d IIC T6		
	Cable connection; Display			
	A	2xM20x1.5, on top; w/o display		
	B	2xM20x1.5, on top; + display		
	C	2x1/2"NPT, on top; w/o display		
	D	2x1/2"NPT, on top; + display		
	1	2xM20x1.5, sidewise; w/o display		
	2	2xM20x1.5, sidewise; + display		
	3	2x1/2"NPT, sidewise; w/o display		
	4	2x1/2"NPT, sidewise; + display		
	Configuration			
	A	Standard		
	Y	Special version, to be specified		
	Neck length N; type			
	1	52 mm; nipple type L		
	2	104 mm; nipple + union type LU		
	3	96 mm; nipple + coupl. type LC		
	4	156 mm; nipple + union + nipple type LUN		
	5	148 mm; nipple + coupl. + nipple type L		
	9 mm, as specified		
	Thermowell type			
	0	not needed		
	1	Bar stock		
	2	Pipe		
	Thermowell connection			
	D	Thread G1/2"		
	N	Thread 1/2"NPT-M		
	P	Thread 3/4"NPT-M		
	U	Thread M24x1.5-F		
	5	Thread 1/2"NPT-F		
	9	Special version, to be specified		
	TC Type; Material			
	A	1x K IEC584, 6mm; INCONEL600		
	B	2x K IEC584, 6mm; INCONEL600		
	C	1x J IEC584, 6mm; 316		
	D	2x J IEC584, 6mm; 316		
	G	1x K ANSI, 6mm; INCONEL600		
	H	2x K ANSI, 6mm; INCONEL600		
	J	1x J ANSI, 6mm; 316		
	K	2x J ANSI, 6mm; 316		
	9	special version, to be specified		
	TC Class; hot junction			
	1	purity cl.2; grounded		
	2	purity cl.1; grounded		
	5	purity cl.2; ungrounded		
	6	purity cl.1; ungrounded		
	9	special version, to be specified		
TMT142C				← Order code (Part 1)

											Insertion length ML	
											X mm
											Y mm, as specified
											Factory test	
											0	not needed
											1	Inspection sensor
											2	Inspection TC+TMT
TMT142C-											← Order code (complete)	

Customized options

Order No. 51003527	TAG print/configuration 8 char
Order No. 51003546	Descriptor print/configuration 16 char
Order No. 51002393	Metal TAG

Accessories**Optional accessories**

Mounting bracket	<ul style="list-style-type: none"> ■ Mounting bracket, stainless steel pipe 1.5-3", 316L Order No. 51007995
Cable gland	<ul style="list-style-type: none"> ■ Cable gland M20x1.5 Order No. 51004949 ■ Cable gland NPT 1/2" D4-8.5, IP68 Order No. 51006845 ■ Cable entry adapter M20x1.5 to NPT 1/2" Order No. 51004387
Overvoltage protection	<ul style="list-style-type: none"> ■ Surge arrester HAW569 Order code: HAW569-A1 1A for non-hazardous areas Order code: HAW569-B1 1A for Ex areas ATEX 2(1)G EEx ia IIC
Active barrier	<ul style="list-style-type: none"> ■ Active barrier RN221 for non-hazardous areas or as Ex version Order code: RN221-... see "Documentation"

Documentation

- FA brochure 'Temperature measuring technology' (FA006T/09/en)
- Installation instructions, FieldCare configuration software (BA031S/04/a4)
- Operating Instructions iTEMP® HART® TMT142 (BA191R/09/a3)
- Operating Instructions 'Fieldgate FXA520' (BA258F/00/en)
- Technical Information 'Fieldgate FXA520' (TI369F/00/en)
- Supplementary Ex documentation:
 - ATEX II2G EEx d: XA048R/09/a3
 - ATEX III1/2D: XA049R/09/a3
 - ATEX III1G: XA050R/09/a3
 - ATEX EEx ia + EEx d: XA051R/09/a3
 - ATEX II3G: XA052R/09/a3
- Technical Information 'Active barrier RN221' (TI073R/09/en)
- Technical Information 'Surge arrester HAW569' (TI103R/09/en)

International Head Quarter

Endress+Hauser
GmbH+Co. KG
Instruments International
Colmarer Str. 6
79576 Weil am Rhein
Germany

Tel. +49 76 21 9 75 02
Fax +49 76 21 9 75 34 5
www.endress.com
info@ii.endress.com

Endress+Hauser 

People for Process Automation