

**ODKL 96B**

**Optical laser distance sensors**

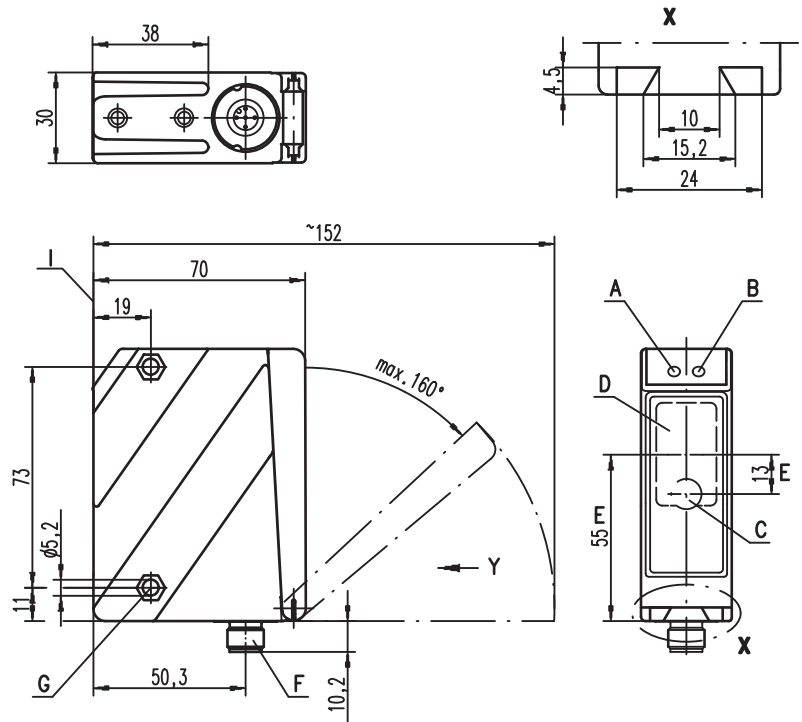

**Dimensioned drawing**



- A Green indicator diode
- B Indicator diode yellow
- C Transmitter
- D Receiver
- E Optical axis
- F Device plug M12x1
- G Countersinking for SK nut M5, 4.2mm deep
- H OLED display and membrane keyboard
- I Reference edge for the measurement (cover glass)

**Electrical connection**

ODKL 96B/C6...

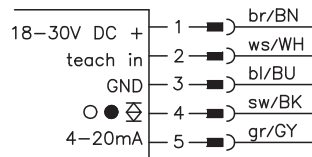

ODKL 96B/D26...

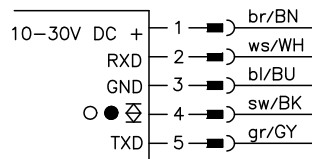

ODKL 96B/V6...

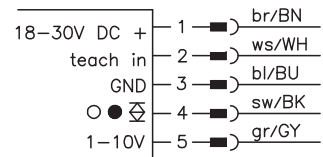

ODKL 96B/D36...

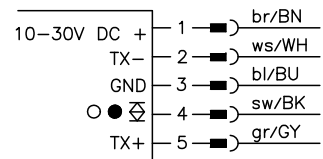

en 03-2013/01 50111880

We reserve the right to make changes • DS\_ODKL96BM\_en\_50111880.fm



**0.3 ... 25m**

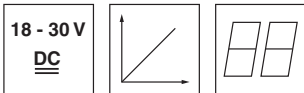

- Measurement range up to 25000mm onto high-gain foil
- Highly insensitive to extraneous light
- Analog current or voltage output
- PC/OLED display and membrane keyboard for configuration
- Measurement value is indicated in mm on OLED display
- Measurement range and mode adjustable



**Accessories:**

(available separately)

- Mounting systems
- Cable with M12 connector (K-D ...)
- Configuration software
- High-gain foil REF 7-A-100x100 (Part No. 50111527)

## Specifications

### Optical data

Measurement range	300 ... 25000mm onto high-gain foil
Resolution	3mm
Light source	laser
Wavelength	658nm (visible red light)
Light spot	approx. 7x7 mm <sup>2</sup> at 10m
Laser warning notice	see Remarks

### Error limits (relative to measurement range end value 25000mm)

Absolute measurement accuracy <sup>1)</sup>	± 0.2 %
Repeatability <sup>2)</sup>	± 10mm
Temperature drift	± 1.5mm/K

### Timing

Measurement time	"Fast" operating mode: 1.4ms	"Standard" operating mode: 10ms	"Precision" operating mode: 50ms (factory setting)
Delay before start-up	≤ 1s		

### Electrical data

Operating voltage U <sub>B</sub>	...C6/V6	18 ... 30VDC (incl. residual ripple)
	...D26/D36	10 ... 30VDC (incl. residual ripple)
Residual ripple		≤ 15% of U <sub>B</sub>
Open-circuit current		≤ 150mA
Switching output		push-pull switching output <sup>3)</sup> , PNP light switching, NPN dark switching
Signal voltage high/low		≥ (U <sub>B</sub> -2 V)/≤ 2V
Analog output	...V6	voltage 1 ... 10V / 0 ... 10V / 1 ... 5V / 0 ... 5V, R <sub>L</sub> ≥ 2kΩ
	...C6	current 4 ... 20mA, R <sub>L</sub> ≤ 500Ω
Serial interface	...D26/D36	RS 232/RS 485, 9600 ... 57600Bd, 1 start bit, 8 data bits, 1 stop bit, no parity
Transmission protocol		14 bit, 16 bit, ASCII, Remote Control

### Indicators

Green LED	continuous light	ready
	off	
Yellow LED	continuous light	object within range / switching output
	off	

### Mechanical data

Housing	diecast zinc
Optics cover	glass
Weight	380g
Connection type	M12 connector

### Environmental data

Ambient temp. (operation/storage)	-20°C ... +50°C / -30°C ... +70°C
Protective circuit <sup>4)</sup>	1, 2, 3
VDE safety class <sup>5)</sup>	II, all-insulated
Protection class	IP 67, IP 69K <sup>6)</sup>
Laser class	2 (acc. to EN 60825-1)
Standards applied	IEC 60947-5-2

- 1) For 300 ... 25000mm measurement range, "Precision" operating mode, floating average calculation taking 30 measurement values into account, at 20°C, medium range of U<sub>B</sub>, measuring on high gain foil REF 7-A-100x100 (50111527)
- 2) Same object, identical environmental conditions, "Precision" operating mode, floating average calculation taking 30 measurement values into account, measuring on high gain foil REF 7-A-100x100 (50111527)
- 3) The push-pull switching outputs must not be connected in parallel
- 4) 1=transient protection, 2=polarity reversal protection, 3=short circuit protection for all outputs
- 5) Rating voltage 250VAC, with cover closed
- 6) IP 69K test in accordance with DIN 40050 part 9 simulated, high pressure cleaning conditions without the use of additives. Acids and bases are not part of the test

## Order guide

	Designation	Part no.
<b>Analogue current output</b>		
Current output	ODKL 96B M/C6-S12	50109297
<b>Analogue voltage output</b>		
Voltage output	ODKL 96B M/V6-S12	50109298
<b>Serial digital output</b>		
RS 232, 1 push/pull output	ODKL 96B/D26-S12	50109299
RS 485, 1 push/pull output	ODKL 96B/D36-S12	50109300

## Tables

## Diagrams

## Remarks

- **Approved purpose:**  
The ODKL 96B laser distance sensors are opto-electronic sensors for the optical, contactless measurement of the distance to objects. This product may only be used by qualified personnel and must only be used for the approved purpose. This sensor is not a safety sensor and is not to be used for the protection of persons.

LASERSTRAHLUNG NICHT IN DEN STRAHL BLICKEN	
Max. Leistung:	248 mW
Impulsdauer:	6,5 ns
Wellenlänge:	658 nm
LASER KLASSE 2 DIN EN60825-1:2003-10	

## ODKL 96B

## Optical laser distance sensors

### Analog output: characteristic curve for factory setting

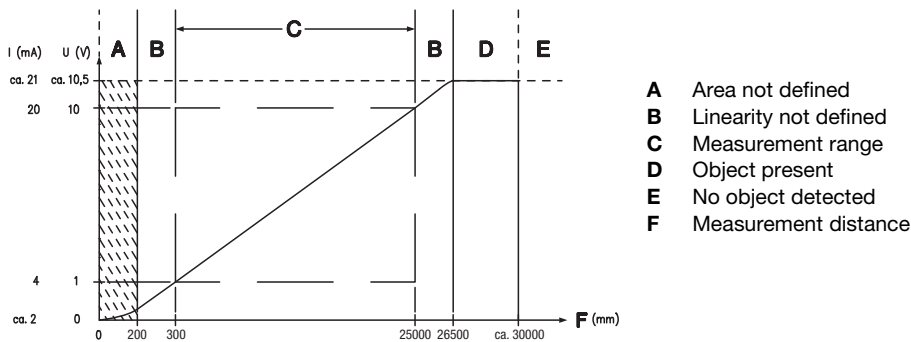

### Serial output: transmission protocol for factory setting

9600Bd, 1 start bit, 8 data bits, 1 stop bit,  
 transmission protocol ASCII measurement values

Transmission format: **MMMMM<CR>**

**MMMMM** = 5-digit measurement value in mm (resolution 1 mm)

**<CR>** = ASCII character "Carriage Return" (x0D)

### Measurement mode and measurement filter

The user can individually adapt the measurement system of the ODKL 96B to various applications. By configuring the measurement mode and measurement filter, either a higher measurement accuracy or, alternatively, faster measurements can be achieved. Configuration can be performed either directly on the sensor or with the ODS 96B configuration software.

#### Optimization of measurement mode

In the Application menu, you can set 3 different measurement filters.

Menu setting	Effect
Application -> Measure Mode -> Precision	high accuracy, measurement time of individual measurement: 50ms
Application -> Measure Mode -> Standard	exact and fast, measurement time of individual measurement: 10ms
Application -> Measure Mode -> Speed	fast measurement, measurement time of individual measurement: 1.4ms

#### Optimization of measurement filter

To achieve more precise measurement values, a measurement filter can be adjusted in addition to the measurement mode. In most cases, the use of a floating average results in a reduction in the variance of the measurement values.

To use this, select the menu setting **Application -> Measure Filter -> Averaging**.

The number of measurement values to be taken into account can be set to a value between **1 ... 99** via menu setting

**Application -> Measure Filter -> Averaging -> Measur. Count**.



#### Notice!

The measurement value display on the OLED display can be used to assess the efficiency of the selected measurement mode and measurement filter in the application. The update rate of the OLED display is always 2Hz. The ODS 96B configuration software provides identical functionality.

#### Factory setting of measurement mode and measurement filter:

On delivery, the sensor is preset so that measurement values with the maximum possible accuracy are achieved:

- Measurement mode **Precision**.

### Reset to factory settings

Press the **←** button while switching on the device to reset the configuration of the ODKL 96B to the state upon delivery from the factory.

Press the **←** button again to reset all parameters to the factory settings. All settings made previously are permanently lost.

Press **▼** and the ODKL 96B returns to measurement operation without resetting the parameters.



You can also use the menu or the configuration software to reset to factory settings. For this purpose, select menu item **Settings -> FactorySettings -> Execute**.

The ODS 96B configuration software can also be used to reset the ODKL 96B to factory settings.

## Teach-in of switching outputs, analog characteristic output curve and Preset



**Notice!**

If you have changed the factory setting for teaching under Input Mode, activate on the OLED display the menu item **Input -> Input Mode -> Teach**.

To teach, proceed as follows:

1. Position measurement object at the desired measurement distance.
2. The respective teach function is activated on the teach input for the duration of a level change **T** (see graphical representation). The level conditions describe the levels with menu setting **Input -> Input Mode -> Input polarity -> Active High +24V** (factory setting).

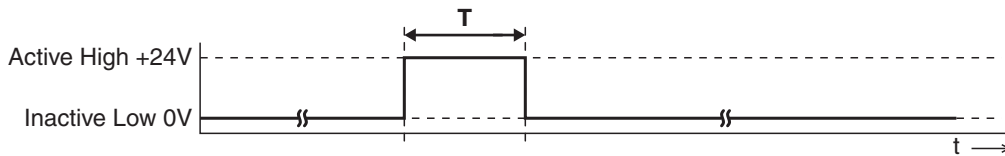

Teach function	Duration T
Switching output Q1	20 ... 80ms
Distance value for start of measurement range = 1V or 4 mA at analog output	220 ... 280ms
Distance value for end of measurement range = 10V or 20mA at analog output	320 ... 380ms



**Notice!**

If the inactive level is continuously applied on the teach input, the teach input is locked.

For menu setting **Input -> Input Mode -> Input polarity -> Active Low +0V**, inverted input signals are used during teaching.

### Preset Teach-In

On the OLED display, activate for this purpose menu item **Input -> Input Mode -> Preset**.

The preset teach occurs in a manner analogous to that for the teach-in for switching output Q1.

## Working safely



**Attention Laser Radiation!**

The optical distance sensors ODKL 96B operate with a red light laser of class 2 acc. to EN 60825-1. If you look into the beam path over a longer time period, the retina of your eye may be damaged!

**Never look directly into the beam path! Do not point the laser beam of the ODKL 96B at persons!**

**When mounting and aligning the ODKL 96B take care to avoid reflections of the laser beam off reflective surfaces!**

**The use of operating and adjusting devices other than those specified in the technical description, carrying out of differing procedures, or improper use of the optical laser distance sensor may lead to dangerous exposure to radiation!**

**The use of optical instruments or devices in combination with the device increases the danger of eye damage!**

**Adhere to the applicable legal and local regulations regarding protection from laser beams acc. to EN 60825-1 in its latest version.**

**The ODKL 96B uses a laser diode with low power in the visible red light range with an emitted wavelength of about 658nm.**

**The glass optics cover is the only opening through which the laser radiation can escape from the device. The housing of the ODKL 96B is sealed and has no parts that need to be adjusted or maintained by the user. The device must not be tampered with and must not be changed in any way! The destruction of the seal voids the warranty!**



**Notice!**

**It is important that you attach the sticky labels supplied to the device (notice signs and laser emission symbol)!**

**If the signs would be covered due to the installation situation of the ODKL 96B, attach them close to the ODKL 96B such that reading the notices cannot lead to looking into the laser beam!**