

LSR 55

Throughbeam photoelectric sensors

en 03-2010/01 50110268-02



Dimensioned drawing

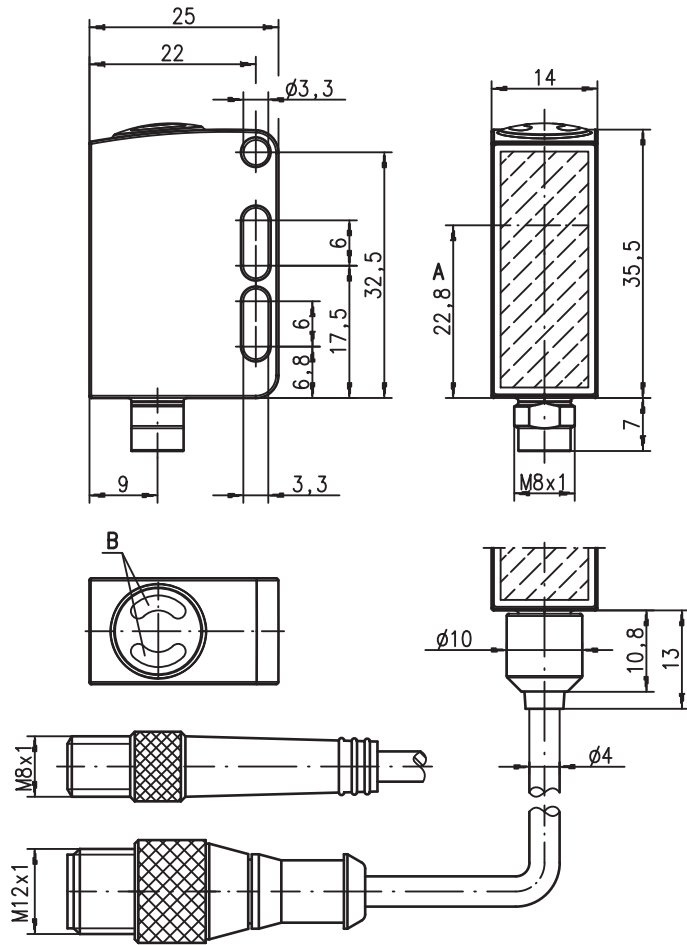

A Optical axis  
B Indicator diode

**0 ... 10m**

- Throughbeam photoelectric sensor with visible red light
- 316L stainless steel housing in WASH-DOWN-Design
- Enclosed optics design prevents bacterial carry-overs
- ECOLAB and CleanProof+ tested
- Paperless device identification
- Scratch resistant and non-diffusive plastic front cover
- High switching frequency for detection of fast events

Electrical connection

Plug connection, 4-pin

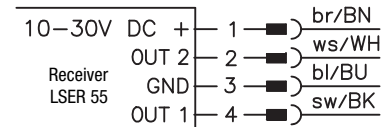
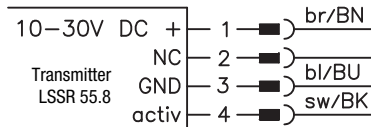

Plug connection, 3-pin

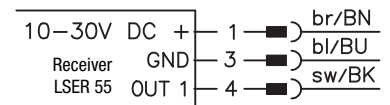
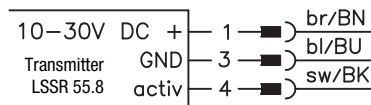

Cable, 4 wires

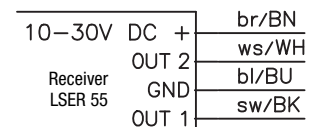
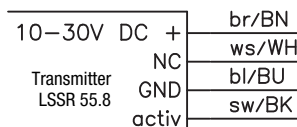

Accessories:

(available separately)

- Cable with M8 or M12 connector (K-D ...)
- Cable for food and beverages
- Mounting devices



We reserve the right to make changes • DS\_LSR55\_en.fm

## Specifications

### Optical data

Typ. operating range limit <sup>1)</sup>	0 ... 10m
Operating range <sup>2)</sup>	0.05 ... 8.5m
Light source <sup>3)</sup>	LED (modulated light)
Wavelength	620nm (visible red light)

### Timing

Switching frequency	1,000Hz (see order guide)
Response time	0.5ms
Delay before start-up	≤ 300ms

### Electrical data

Operating voltage $U_B$ <sup>4)</sup>	10 ... 30VDC (incl. residual ripple)
Residual ripple	≤ 15% of $U_B$
Open-circuit current	≤ 14mA (per sensor)
Switching output	.../66 <sup>5)</sup> 2 push-pull switching outputs pin 2: PNP dark switching, NPN light switching pin 4: PNP light switching, NPN dark switching .../6 <sup>5)</sup> 1 push-pull switching output pin 4: PNP light switching, NPN dark switching light/dark switching
Function characteristics	
Signal voltage high/low	≥ ( $U_B - 2V$ ) ≤ 2V
Output current	max. 100mA
Operating range	fixed setting

### Indicators

Green LED	ready
Yellow LED	light path free
Flashing yellow LED	light path free, no performance reserve

### Mechanical data

Housing	AISI 316L stainless steel, DIN X2CrNiMo17132, W.No1.4404
Housing design	WASH-DOWN-Design
Housing roughness <sup>6)</sup>	$R_a \leq 2.5$
Connector	AISI 316L stainless steel, DIN X2CrNiMo17132, W.No1.4404
Optics cover	coated plastic (PMMA), scratch resistant and non-diffusive
Operation	plastic (TPV - PE), non-diffusive
Weight	with M8 connector: 40g with 200mm cable and M12 connector: 60g with 5000mm cable: 110g
Connection type	M8 connector, 3-pin or 4-pin, 0.2m cable with M12 connector, 4-pin, 5m cable, 4 x 0.20mm <sup>2</sup>

### Environmental data

Ambient temp. (operation/storage) <sup>7)</sup>	-30°C ... +70°C / -30°C ... +70°C
Protective circuit <sup>8)</sup>	2, 3
VDE safety class <sup>9)</sup>	III
Protection class	IP 67, IP 69K <sup>10)</sup>
Environmentally tested acc. to LED class	ECOLAB, CleanProof+
Standards applied	1 (acc. to EN 60825-1)
Certifications	IEC 60947-5-2 UL 508 <sup>4)</sup>
Chemical resistance	tested in accordance with ECOLAB and CleanProof+ (see remarks)

### Options



#### Activation input

Transmitter active/not active	≥ 8V/≤ 2V
Activation/disable delay	≤ 1ms
Input resistance	30kΩ

- 1) Typ. operating range limit: max. attainable range without performance reserve
- 2) Operating range: recommended range with performance reserve
- 3) Average life expectancy 100,000h at an ambient temperature of 25°C
- 4) For UL applications: for use in class 2 circuits according to NEC only
- 5) The push-pull switching outputs must not be connected in parallel
- 6) Typical value for the stainless steel housing
- 7) Operating temperatures of +70°C permissible only briefly (≤ 15min)
- 8) 2=polarity reversal protection, 3=short-circuit protection for all transistor outputs
- 9) Rating voltage 50V
- 10)Only in combination with M12 connector

## Tables

0	8.5	10
---	-----	----

	Operating range [m]
	Typ. operating range limit [m]

## Diagrams

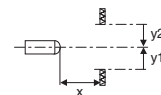
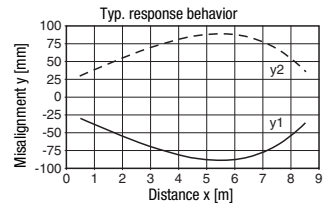

## Remarks

A light axis consists of a transmitter and a receiver with the following designations:

<b>LSR</b>	=	<b>Complete light axis</b>
<b>LSSR</b>	=	<b>Transmitter</b>
<b>LSER</b>	=	<b>Receiver</b>

A list of tested chemicals can be found in the first part of the product description.

### Approved purpose:

The throughbeam photoelectric sensors are optical electronic sensors for optical, contactless detection of objects.

This product may only be used by qualified personnel and must only be used for the approved purpose. This sensor is not a safety sensor and is not to be used for the protection of persons.

**Order guide**

Selection table		Order code →			
Equipment ↓		LSR 55/66.8-S8 Part No. 50108715 (Tr) Part No. 50108721 (Re)	LSR 55/66.8, 200-S12 Part No. 50108717 (Tr) Part No. 50108723 (Re)	LSR 55/6.8-S8.3 Part No. 50108716 (Tr) Part No. 50108722 (Re)	LSR 55/66.8, 5000 Part No. 50111969 (Tr) Part No. 50111970 (Re)
Switching output	1 x Push-pull switching output			●	
	2 x Push-pull switching output	●	●		●
Switching function	1 PNP light switching and NPN dark switching output	●	●	●	●
	1 PNP dark switching and NPN light switching output	●	●		●
Connection	M8 connector, metal, 4-pin	●			
	M8 connector, metal, 3-pin			●	
	cable 200 mm with M12 connector, metal, 4-pin		●		
	cable 5000 mm, 4 wires				●
Indicators	green LED: ready	●	●	●	●
	yellow LED: switching output	●	●	●	●
Features	activation input	●	●	●	●

