

# Leuze electronic

the sensor people

SMART  
SENSOR  
BUSINESS

## DB 14B Double Sheet Testing Unit

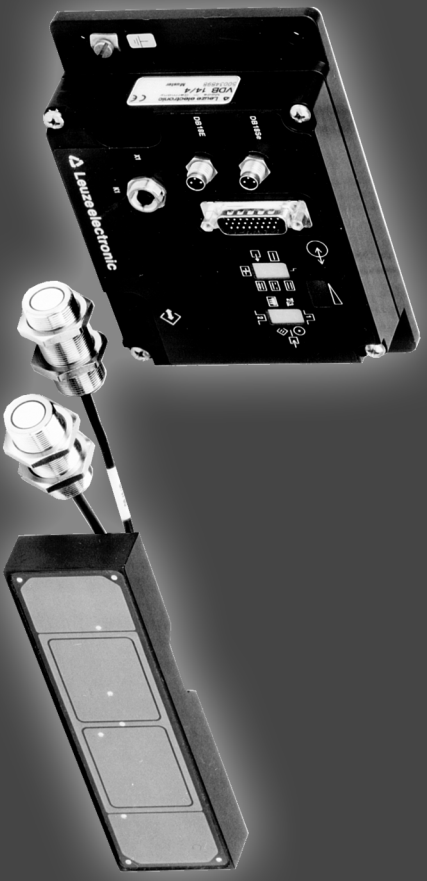

en 02-2015/09 50131012  
We reserve the right to  
make technical changes

Original operating instructions

© 2015

Leuze electronic GmbH + Co. KG

In der Braike 1

D-73277 Owen / Germany

Phone: +49 7021 573-0

Fax: +49 7021 573-199

<http://www.leuze.com>

[info@leuze.de](mailto:info@leuze.de)

<b>1</b>	<b>General information .....</b>	<b>4</b>
1.1	Explanation of symbols .....	4
1.2	Declaration of conformity .....	4
<b>2</b>	<b>Safety notices .....</b>	<b>5</b>
2.1	Safety standards .....	5
2.2	Approved purpose.....	5
2.3	Areas of application .....	5
2.4	Organisational measures .....	5
<b>3</b>	<b>Description of the device and system .....</b>	<b>6</b>
3.1	Set-up of the DB 14B .....	6
3.2	Performance features of the DB 14B .....	6
3.3	Function description DB 14B .....	7
3.4	Delivery contents / accessories / order codes .....	8
<b>4</b>	<b>Installation .....</b>	<b>9</b>
4.1	Storage, transportation .....	9
4.2	Mounting .....	10
4.3	Connection .....	13
4.4	Disassembling, packing, disposing .....	14
<b>5</b>	<b>Commissioning .....</b>	<b>15</b>
5.1	Before switching on for the first time .....	15
5.2	Display and control elements .....	15
5.2.1	VDB 14B evaluation unit.....	15
5.2.2	Indicator functions.....	16
5.2.3	Indicators VDB 14B/4 / VDB 14B/2.....	17
5.3	Switching on.....	19
5.4	Adjustment .....	19
5.4.1	Starting adjustment.....	19
5.4.2	Adjusting the ultrasonic sensors .....	19
5.4.3	Adjusting the capacitive sensor .....	21
5.4.4	Terminating adjustment .....	21
<b>6</b>	<b>Sheet testing .....</b>	<b>22</b>
6.1	Conditions for readiness .....	22
6.2	Operating states.....	22
6.3	Calibration .....	23
6.3.1	Calibration error .....	23
6.4	Testing for double sheets.....	23
6.5	Testing for second sheets.....	24
6.6	Evaluation process.....	25

<b>7</b>	<b>Interfaces</b> .....	<b>27</b>
7.1	Serial interface .....	27
7.2	Analogue interface .....	28
<b>8</b>	<b>Error messages (flashing)</b> .....	<b>29</b>
<b>9</b>	<b>Dimensioned drawings</b> .....	<b>33</b>
<b>10</b>	<b>Specifications</b> .....	<b>35</b>
<b>11</b>	<b>Maintenance</b> .....	<b>37</b>
11.1	General maintenance information .....	37
11.2	Repairs and maintenance .....	37
<b>12</b>	<b>Appendix: 2/3 sheet mode</b> .....	<b>38</b>
12.1	Explanations of the calibration function .....	39
12.2	Error case A: Multiple inquiries on the first sheet or multiple single sheets before start of overlap	43
12.3	Error case B: Double sheet on inquiry of the first sheet.....	44
12.4	Error case C: Double sheet during calibration on the second sheet.....	44
12.5	Error case D: One or more single sheets with subsequent double sheet at start of overlap .	45
12.6	Symbol legend .....	46
12.7	Critical cases in the overlap flow with 2/3 sheet scanning .....	47

Figure 3.1:	DB 14B system set-up.....	6
Figure 4.1:	Example for the sensor arrangement.....	10
Figure 4.2:	Mounting the ultrasonic sensors.....	11
Figure 4.3:	Mounting the capacitive sensor.....	12
Figure 4.4:	Potential equalisation and connection.....	12
Table 4.1:	Pin assignments of the 26-pin SUB-D connector.....	13
Figure 5.1:	VDB 14B evaluation unit.....	15
Figure 5.2:	Control inputs.....	16
Figure 5.3:	Control outputs.....	17
Table 5.1:	Indicators VDB 14B.....	17
Figure 5.4:	Signal level of the DB 18 UP.....	20
Table 5.2:	Signal level of the DB 18 UP.....	20
Figure 6.1:	Evaluation process.....	26
Figure 7.1:	Interface symbol.....	27
Table 7.1:	Assignments of the serial interface.....	27
Table 7.2:	Assignments of the analogue interface X1.....	28
Table 8.1:	Error messages.....	29
Figure 9.1:	Dimensions of the VDB 14B evaluation unit.....	33
Figure 9.2:	Capacitive sensor DB 14 K.....	34
Figure 9.3:	Ultrasonic transducer DB 18 UP.....	34
Figure 12.1:	Critical case 1.....	47
Figure 12.2:	Critical case 2.....	47
Figure 12.3:	Critical case 3.....	48
Figure 12.4:	Critical case 4.....	48

## 1 General information

### 1.1 Explanation of symbols

The symbols used in this operating manual are explained below.



**Attention!**

*Pay attention to passages marked with this symbol. Failure to heed this information can lead to injuries to personnel or damage to the equipment.*



**Notice!**

*This symbol indicates text passages containing important information.*

### 1.2 Declaration of conformity

The DB 14B double sheet testing unit sensor system has been developed and manufactured subject to the applicable European standards and directives.



**Notice!**

*The corresponding declaration of conformity can be requested from the manufacturer.*

The manufacturer of the product, Leuze electronic GmbH + Co. KG in D-73277 Owen/Teck, possesses a certified quality assurance system in accordance with ISO 9001.



## 2 Safety notices

### 2.1 Safety standards

The DB 14B double sheet testing unit has been developed subject to the applicable safety standard IEC 947-5-2.

### 2.2 Approved purpose

The DB 14B double sheet testing unit has been conceived as a monitoring device mainly for paper working machines. It monitors incoming paper sheets and is used to detect and signal double sheets in the sheet feeder during operation.



**Attention!**

***The double sheet testing unit is not a safety module acc. to EU machinery directive!***

*The protection of machine and the device cannot be guaranteed if the device is operated in a manner not corresponding to its intended use.*

*Access to or changes on the device, except where expressly described in this operating manual, is not authorised.*

### 2.3 Areas of application

Double sheets of the following materials with thicknesses from 20g/m<sup>2</sup> airmail paper to 2mm thick cardboard can be recognised reliably by the DB 14B:

- Paper
- Paperboard
- Cardboard
- Plastic foil

### 2.4 Organisational measures

All entries in this operating manual must be heeded, in particular those in the sections "Safety Notices" and "Commissioning".

Carefully store this operating manual where it is accessible at all times.

***Safety regulations***

Observe the locally applicable safety regulations.

***Qualified personnel***

Mounting, commissioning and maintenance of the device must only be carried out by qualified personnel.

### 3 Description of the device and system

#### 3.1 Set-up of the DB 14B

The basic version of the DB 14B double sheet testing unit consists of the evaluation unit VDB 14B/4 (PNP) or VDB 14B/4 (NPN), one transmitter DB 18 U, one receiver DB 18 U, and a connection cable for the machine control system. It can be additionally equipped with a capacitive sensor DB 14 K.

The capacitive sensor DB 14 K is required if double sheets of thick material, sheets with air pockets or material with low transmission for ultrasonic signals should be recognised.

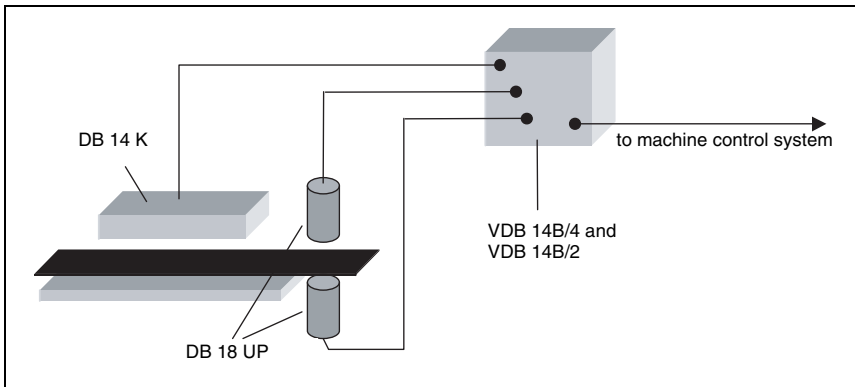

Figure 3.1: DB 14B system set-up

#### 3.2 Performance features of the DB 14B

The DB 14B is a system which detects multiple sheets of paper. It is characterised by the following features:

- A large measuring range from 20g airmail paper to 2mm thick, homogeneous cardboard (capacitive >150g normal paper)
- Insensitive to printing and fluttering of paper
- Manual self-calibration
- Automatic readjustment during operation
- Extensive diagnostic options via 2-digit, 7 segment display



### **3.3 Function description DB 14B**

The double sheet testing unit DB 14B is a computer-assisted system for the recognition of multiple sheets of paper or cardboard and is applicable for use in clock-controlled machines. After storing a material-specific reference value, the system can recognise multiple sheets of paper and thus prevent damage to the machine.

The DB 18 UP ultrasonic sensors consists of a transmitter and a receiver and perform two functions. They recognise the presence of a sheet of paper by the interruption of the sound level and at the same time measure the signal level for the given type of paper. After calibration to the reference sheet, it can be determined whether zero, one or two sheets of paper are in the ultrasonic beam. The double sheet testing unit can optionally be switched to perform a capacitive measurement of the double sheet. In this operating mode, however, the ultrasonic sensors remain necessary for sheet detection (start of measurement).

The reference value is always corrected to the current conditions by automatic readjustment during operation. The testing of the sheet overlap is allowed by the possibility of an additional second inquiry at a time when two sheets should be at the measurement position and to give a warning signal should the second sheet be missing.

The perfect operation of the double sheet testing unit is checked by an integrated self-test after power-on of the DB 14B.

### 3.4 Delivery contents / accessories / order codes

*The minimum configuration requires:*

Evaluation unit	<b>VDB 14B/4 (PNP)</b>	<b>501 06083</b>
	and <b>VDB 14B/2 (NPN)</b>	<b>501 06807</b>
Sensors	<b>DB 18 UP sensor pair</b> Transmitter/receiver, M18 sensor housing, 25mm sensor length, 2.5m cable length	<b>501 08998</b>
Connection cable	<b>BK7 KB140-2000-20</b> 26-pin Sub-D socket, 20 strands assigned, 2m cable length	<b>500 37338</b>

*Available accessories:*

Capacitive sensor	<b>DB 14 K - 7</b> Actuation distance 7mm	<b>500 34899</b>
	<b>DB 14 K - 12</b> Actuation distance 12mm	<b>500 39790</b>
Sensors	<b>DB 18 UP,2500</b> Transmitter/receiver, M18 sensor housing, 40mm sensor length, 2.5m cable length	<b>501 08997</b>
Connection cable	<b>BK7 KB140-5000-20</b> 5m cable length	<b>500 37339</b>

## 4 Installation

### 4.1 Storage, transportation

**Attention!**

*When transporting, package the device so that it is protected against collision and humidity. Optimal protection is achieved when using the original packaging. Heed the required environmental conditions specified in the technical data.*

- ↳ *Check the packaging for any damage. If damage is found, notify the post office or shipping agent as well as the supplier.*
- ↳ *Check the delivery contents using your order and the delivery papers:*
  - *delivered quantity*
  - *device type and model as indicated on the nameplate*
  - *accessories*
  - *operating instructions*
- ↳ *Keep the original packaging in case the device should be stored or transported at some future time.*

Please contact your supplier or your Leuze distributor to answer any questions (see inside of the front cover of these operating instructions).

**Notice!**

*Observe the local regulations regarding disposal of packaging material.*

## 4.2 Mounting

The components of the DB 14B should be mounted in the following order:

1. Ultrasonic and capacitive sensors
2. Evaluation unit

As long as the sensors are aligned according to the following instructions, the fitting position of all components is arbitrary.

The following arrangement is, however, recommended:

First, the ultrasonic sensors should be covered in the direction of paper travel and then the capacitive sensor should be covered.

The space requirements of the individual components can be found in the dimensioned drawings in chapter 9.

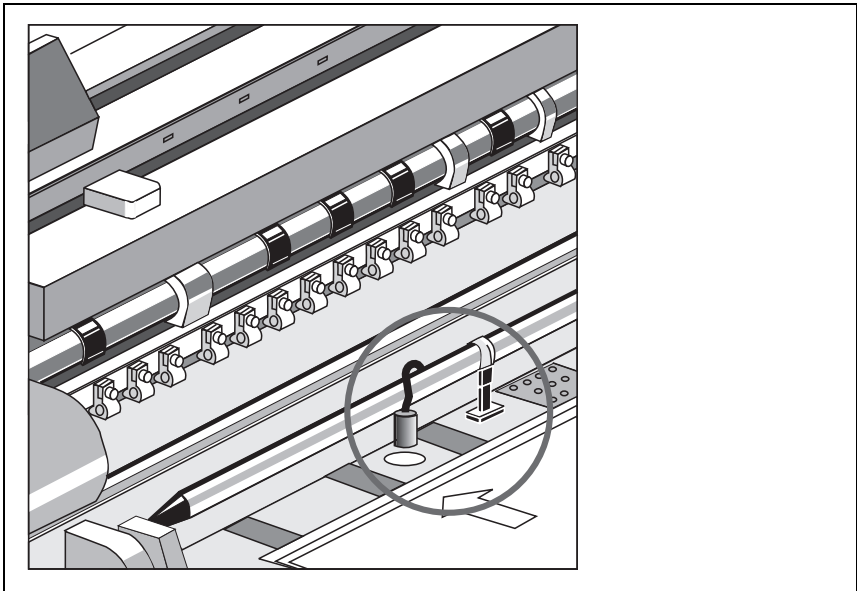

Figure 4.1: Example for the sensor arrangement



### **Notice!**

*The transmitter and receiver of the ultrasonic sensors must be mounted on the feeder platform at a position where a single sheet is present for at least 2ms during normal operation.*

**Mounting the DB 18 UP ultrasonic sensors**

The transmitter and receiver (DB 18 UP) are identical in construction and are to be mounted according to the table in figure 4.2 at an angle which is inclined relative to vertical. A larger angle of inclination increases the flutter range; e.g. with a 35° pitch, flutter is permissible within 50% of the measurement field.

The recommended distance is 20 ... 40mm. The maximum distance is 60mm. The ultrasonic transmitter should be installed from below, approx. 5mm below the table top. The receiver should be installed above the platform top.

Ensure that alignment is exact ( $\pm 1^\circ$ ). If the alignment does not run along the axis, the working range is reduced.

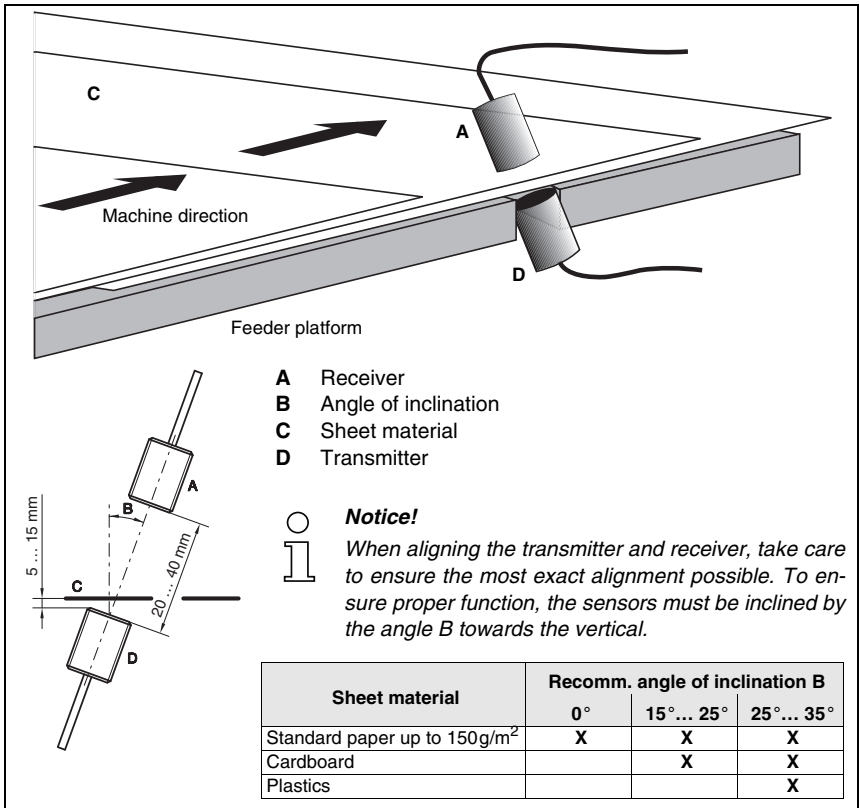

Figure 4.2: Mounting the ultrasonic sensors



**Notice!**

In order to measure, the capacitive sensor requires an electrically conductive grounding plate for the opposite pole which is at least as large as itself. Usually the (metallic) feeder platform serves this function.

**Mounting the capacitive sensor**

The capacitive sensor should be mounted parallel to the feeder platform/grounding plate at a distance of  $7\text{mm} \pm 0.5\text{mm}$  (DB 14 K - 7) or  $12\text{mm} \pm 0.5\text{mm}$  (DB 14 K - 12), respectively. It is usually not necessary to readjust the sensor - grounding plate distance afterwards.

Fix a grounding plate in a non-metallic feeder platform, taking care that the sheet movement is not disturbed.

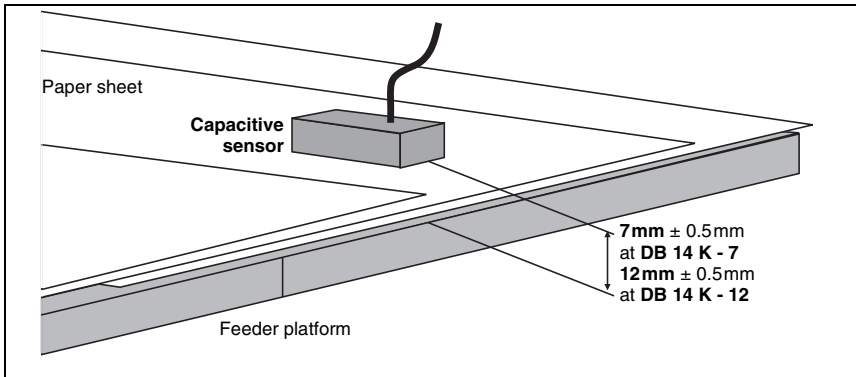

Figure 4.3: Mounting the capacitive sensor

Connect the capacitive sensor and grounding plate with a potential equalisation cable. This is absolutely necessary for a correct measurement. The potential equalisation cable must also be connected to the machine foundation plate as well as to the VDB 14B.

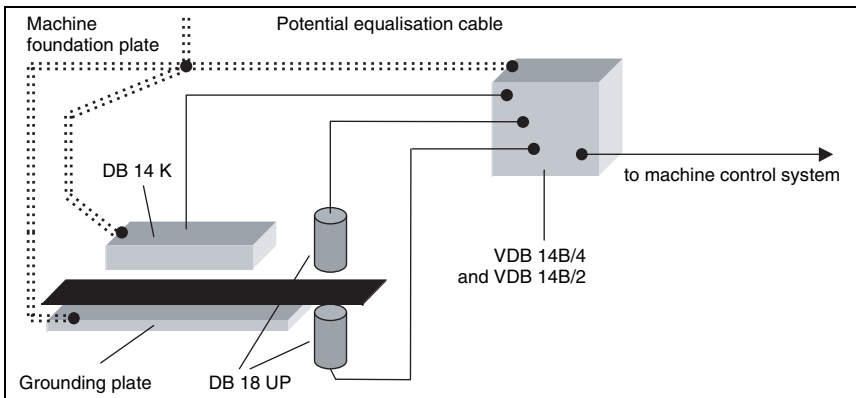

Figure 4.4: Potential equalisation and connection

**VDB 14B evaluation unit**

Use four M4 screws to mount the evaluation unit close to the sensors.

### 4.3 Connection

Connect all individual components to the VDB 14B evaluation unit.



**Attention!**

The 26-pin Sub-D socket of the connection cable to the machine control as well as all DB 18 U... and DB 14 K sensors must only be plugged in while in a voltage-free state. **If the DB 14 K capacitive sensor is plugged in or unplugged during operation, this is not detected by the VDB 14B evaluation unit!**

- Ultrasonic transmitter → DB 18 U...
- Ultrasonic receiver → DB 18 U...
- Capacitive sensor DB 14 K → K1
- Machine control system → 26-pin SUB-D connector with shielded cable

The following table describes the pin assignments of the 26-pin connector.

PIN	Colour	Function
1	red	supply +18 ... 30VDC (+UB)
2	blue	supply 0VDC (GND)
		<b>Inputs</b>
3	violet	1st inquiry, single sheet check
4	white-green	2nd inquiry, second sheet check (last sheet recognition)
5	red-blue	activation and error reset
6	white-yellow	calibration
7	black	switching capacitive – ultrasonic (high – low)
8	brown-green	switching sheet mode 1/2 to 2/3 (option)
9	yellow-brown	With "high" edge evaluation of the 1st inquiry With "low" window evaluation during a neg. cam of the 1st inquiry
		<b>Outputs</b>
10	grey-pink	sheet mode status 1/2 or 2/3 (option)
11	pink	double sheet recognised
12	grey	ready and calibrated
13	brown	error
14	green	2nd sheet missing
15	yellow	ultrasonic beam interrupted, first sheet recognition
16	white	double sheet detected (sheet overlap signal)

Table 4.1: Pin assignments of the 26-pin SUB-D connector

17	white-pink	reserved <sup>1)</sup>
18	pink-brown	reserved <sup>1)</sup>
19		reserved <sup>1)</sup>
20	white-grey	reserved <sup>1)</sup>
21	grey-brown	reserved <sup>1)</sup>
22		reserved <sup>1)</sup>
23		reserved <sup>1)</sup>
24		reserved <sup>1)</sup>
25		reserved <sup>1)</sup>
26		reserved <sup>1)</sup>

Table 4.1: Pin assignments of the 26-pin SUB-D connector

1) Some reserved connections are connected to the 26-pin connector but are not, however, assigned in the device.

## 4.4 Disassembling, packing, disposing

### **Repacking**

For later reuse, the system is to be packed so that it is protected against shocks and dampness. Optimal protection is achieved when using the original packaging.



### **Notice!**

*Electrical scrap is a special waste product! Observe the locally applicable regulations regarding disposal of the product. The DB 14B double sheet testing unit does not contain any internal batteries which would otherwise need to be removed before disposal.*



## 5 Commissioning

### 5.1 Before switching on for the first time

- ↪ *Make yourself familiar with the operation and settings of the system before switching on for the first time!*
- ↪ *Before switching on, recheck all connections and ensure that they have been properly made.*

### 5.2 Display and control elements

#### 5.2.1 VDB 14B evaluation unit

All plug connections for the system are located on the front side of the VDB 14B evaluation unit. In addition, all indicator elements are also located here.

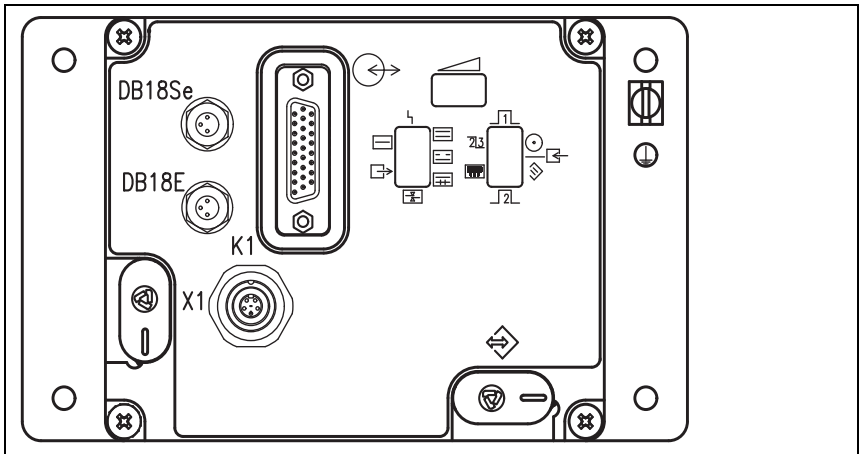

Figure 5.1: VDB 14B evaluation unit

The two 7 segment displays indicate the respective states of the inputs and outputs and, in the case of an error, the appropriate error code. The **error code flashes in the display**. In adjustment mode, the operating point of the capacitive sensor is indicated in the indicators.

### 5.2.2 Indicator functions

The indicator functions of the two 7 segment displays are described below.



**Notice!**

*Error codes of the double sheet testing unit flash in the displays.*

#### Control inputs

Figure 5.2 shows the right-hand indicator field, which describes the control inputs of the DB 14B double sheet testing unit. The indicator elements are connected to the inputs and thus reflect the outputs of the machine controller.

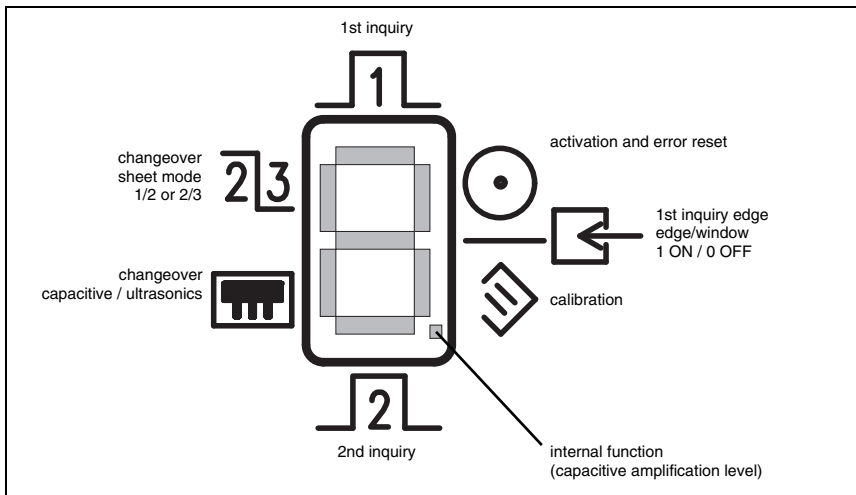

Figure 5.2: Control inputs

**Control outputs**

Figure 5.3 shows the left-hand indicator field, which describes the control outputs of the DB 14B double sheet testing unit. The indicator elements are connected to the outputs and thus reflect the signals sent to the machine controller.

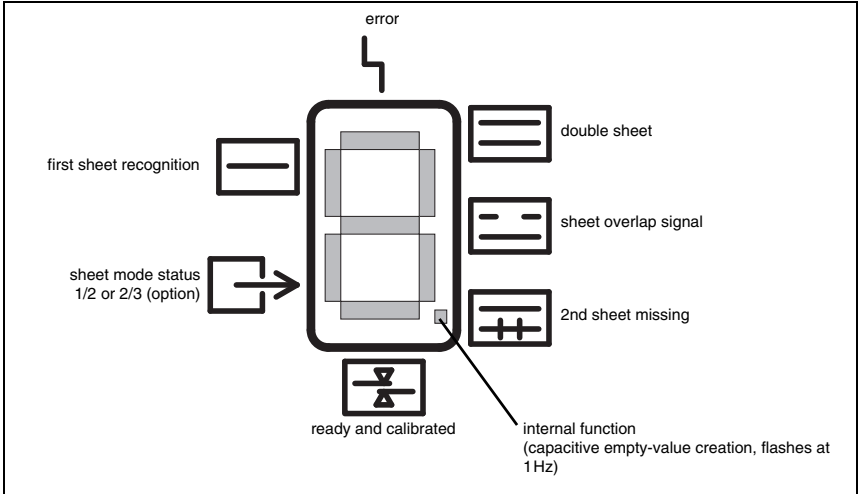

Figure 5.3: Control outputs

**5.2.3 Indicators VDB 14B/4 / VDB 14B/2**

Indicators VDB 14B	
Symbol	Designation
	ready and calibrated
	first sheet recognition
	double sheet

Table 5.1: Indicators VDB 14B

Indicators VDB 14B	
	second sheet missing (last sheet recognition)
	sheet overlap signal
	error
	1st inquiry
	2nd inquiry
	activation and error reset
	calibration
	switching capacitive - ultrasonic
	switching sheet mode 1/2 and 2/3 (option)
	1st inquiry edge/window mode (edge-high/window-low)
	sheet mode status 1/2 or 2/3 (option) (1/2 – low / 2/3 – high)

Table 5.1: Indicators VDB 14B

## 5.3 Switching on

The DB 14B double sheet testing unit does not have a particular switch for switching on and off. The device is switched on and off through application of the supply voltage.

**Notice!**

*After applying the supply voltage, it may take up to 3min. before the DB 14B is ready for operation. The non-ready state after power-on is indicated by the rotating bar in the 7 segment display.*

## 5.4 Adjustment

The sensors are adjusted to the installation conditions in the adjustment mode. The DB 14B double sheet testing unit needs to be adjusted when

- first commissioned (even when working with only the ultrasonic sensors)
- a sensor or an evaluation unit is exchanged, added or removed
- height adjustment, distance change, change in the sensors' angle setting

**Notice!**

*Adjustment can only take place when the sheet feeder is off. Ensure that the LED for "Activation" is off. Also make sure that there is no sheet in the measuring area.*

### 5.4.1 Starting adjustment

Send a series of 12 pulses within 10 seconds to calibration input (PIN 6) from the machine control system. The pulses as well as the pauses between the pulses should each be longer than 100 ms!

Once the adjustment has started, a self-test is performed like when switching on. The VDB 14B automatically recognises whether or not a capacitive sensor is connected and registers or cancels it, respectively, with the system.

**Notice!**

*During adjustment, the states of the outputs are undefined.*

### 5.4.2 Adjusting the ultrasonic sensors

After adjustment has started, the VDB 14B checks the sensor signals when DB 18 UP ultrasonic sensors are connected. The signal status is indicated by means of the three different-coloured LEDs, which are located between the two indicator segments.

The figure 5.4 shows a depiction of the input signal with the aid of the three LEDs.

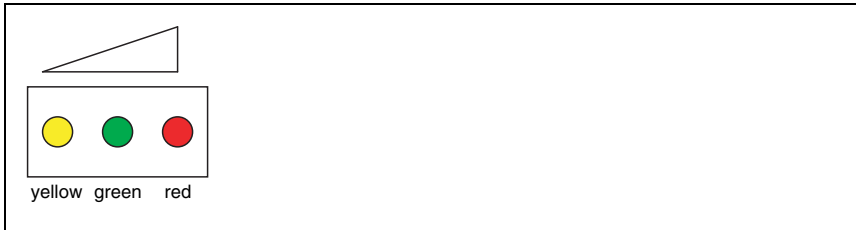

Figure 5.4: Signal level of the DB 18 UP

Shown in table 5.2 are the meanings of the various LEDs used to indicate the receiving level of the ultrasonic sensor. Note that the red LED does not have a function at this time.

Yellow	Green	Red	Function
ON	ON	without function	level high, alignment OK
ON	FLASHING		level not sufficient, alignment not yet OK
ON	OFF		level weak
FLASHING	OFF		level very weak
OFF	ON		normal state after conclusion of the adjustment process; if an error has occurred, note the error message shown on the 7 segment displays

Table 5.2: Signal level of the DB 18 UP

The double sheet testing unit functions properly only when alignment of the sensors has been performed optimally. When the level is ideal, the yellow and green LEDs always illuminate during adjustment.

To change the receiving level, the transmitter of the ultrasonic sensors should be adjusted or moved until the ideal level is achieved.

With ultrasonic sensors, the transmitter should ideally always be installed below. As a result of the continuously emitted ultrasonic signal, a certain degree of self-cleaning is achieved.

If the ultrasonic sensors are not connected or are not adjusted, the double sheet testing unit cannot function.

### 5.4.3 Adjusting the capacitive sensor

To achieve proper function of the capacitive sensor, the sensor must be adjusted during commissioning of the double sheet testing unit. To do this, the sensor must be aligned with respect to the counter electrode. This distance to the counter electrode should be  $7\text{ mm} \pm 0.5\text{mm}$ .

The alignment of the capacitive sensor is displayed with two digits on the 7 segment display of the VDB 14B amplifier during adjustment. The value range may be between 0 and 99.

The display value is dependent on several factors with different weighting. The factors include e.g. distance to the counter electrode, air humidity, temperature and others.

For the capacitive sensors used up to now, the display range was from 30 ... 90 in the normal range and has led to good results.

**Weighting:**

01 → **distance** to the counter electrode **too small**

99 → **distance** to the counter electrode **too large**

or no capacitive sensor connected

If the capacitive sensor is not correctly adjusted, no calibration can be performed with the sensor. In this case, the double sheet testing unit can only be operated with the ultrasonic sensors.

### 5.4.4 Terminating adjustment

The adjustment procedure lasts **at least 10 seconds**.

To terminate the adjustment, an additional (13th) pulse must be applied at the calibration input (PIN 6). The adjustment is concluded **approx. 15 seconds after this last pulse is applied**.

The adjustment is now terminated and the VDB 14B evaluation unit recognises the parameters of the connected sensors. **Before initiating sheet testing operation it is now necessary to calibrate to the paper type** so that the VDB 14B can reliably recognise double sheets.

If the 7 segment display flashes after the adjustment has terminated, you can find the significance of the error message in chapter 8.



**Notice!**

*The error message (flashing 7 segment display) disappears as soon as a pulse is applied at the calibration input (PIN 6) or at the activation input (PIN 5).*

*If the adjustment is interrupted by e.g. voltage interruption etc., a new adjustment start must be performed as described in chapter 5.4.1.*

## 6 Sheet testing

### 6.1 Conditions for readiness

The following conditions must be met before the double sheet testing unit is ready for operation:

- the voltage supply must be applied to the VDB 14B
- the sensors (DB 18 UP) must be connected and correctly aligned.
- the VDB 14B must be correctly adjusted (see section section 5.4)
- the VDB 14B must be calibrated
- the activation should be applied at PIN 5

To restore operational readiness of the double sheet testing unit with detected double sheet after an error message occurs, perform the following:

- remove the double sheet
- deactivate the VDB 14B and activate it again

### 6.2 Operating states

The DB 14 has two states of operation: "activated" and "deactivated", which can only be controlled using the "activation" input.

During the "**activated**" state of operation

- +24VDC (high) must be applied at PIN 5 (applies for PNP-circuitry)
- the segment "Activation + error reset"  illuminates on the 7 segment display of the double sheet testing unit.
- the VDB 14B is ready for sheet testing if a calibration has been previously performed, i.e. upon receiving the inquiry signal on input "1st inquiry" (PIN 3), the VDB 14B tests whether a missing sheet, a single sheet or a double sheet is in the measurement area and switches on the corresponding outputs.

During the "**deactivated**" state of operation

- 0VDC (low) must be applied at input PIN 5 or the input must not be connected (applies for PNP wiring)
- the segment "Activation + reset error"  on the 7 segment display of the double sheet testing unit is off.



## 6.3 Calibration

If the sheet material is changed, it is necessary to calibrate the DB 14B again.

The calibration is controlled by the machine and can only be performed when the activation input (PIN 5) is switched off. Make certain here that the segment of the "Activation + reset error" indicator has switched off before you begin the calibration.

- ↳ *For a functionally reliable calibration, the capacitive sensor must be connected to the supply voltage for at least 10 min.*
- ↳ *Hold a reference sheet of the current print media in the measurement area. Make certain that the ultrasonic sensors as well as the capacitive sensor are completely covered.*
- ↳ *Apply +24VDC (high) at the "calibration" (PIN 6) input (applies for PNP circuitry). The signal for the "calibration" function must always be at least 100 ms long. This signal initiates the calibration of the VDB 14B and the reference value is stored.*

Following successful calibration, the "Ready and calibrated" segment illuminates and +24VDC (high) is present at output PIN 12 (applies for PNP wiring).

The calibration value and the ultrasonic or capacitive operating mode are stored in the VDB 14B in such a way that they are protected against power interruption. The system is thus already calibrated and ready for operation after switching off and back on.

### 6.3.1 Calibration error

It can happen that a calibration of the VDB 14B is not possible because the reference material is too thin, too thick or not suitable. In this case the "ready" output (PIN 12) is switched off and the "error" output (PIN 13) is switched on.

The 7 segment display then displays a corresponding, 2-digit error message (flashing display). The error indicated by the plain text message can be found in chapter 8.

## 6.4 Testing for double sheets

The normal operation of the double sheet testing unit is achieved only following calibration. The system is not ready for monitoring until the "ready and calibrated" output is activated.

The double sheet testing unit always detects the current state between the sensors in the measurement area. As soon as an inquiry pulse sent by the machine is present at input "1st inquiry" of the VDB 14B, the double sheet testing unit outputs the status to the outputs. The number of sheets in the measurement area must remain constant for the 2ms required for the measurement.

During normal operation of the machine, only one sheet should be present between the sensors or be pulled into the machine. In this case, the double sheet testing unit outputs a "high" signal at the output "first sheet detection" (PIN 15).

### **Double sheet**

As soon as two sheets are detected, the output "double sheet detected" (PIN 11) is set and +24VDC (high) output at the output. A signal for the double sheet is output no later than 2 ms after the inquiry pulse.

After the double sheet is detected and the machine has been stopped, the following steps can be performed in order to restart the machine:

↳ *The activation (PIN 5) must be switched off (low-signal) and both sheets must be removed from the measurement path. Afterward, the two measurement paths between the sensors must be completely free.*

The error message "double sheet" remains until the double sheet has been manually removed from the machine and the error message has been deleted from the machine by means of the activation input (PIN 5).

**Attention!**

*If the VDB 14B is in the "double sheet" state, nearly all other functions are disabled.*

## 6.5 Testing for second sheets

By means of a second inquiry signal from the machine, it is possible to query at a defined point in time for two sheets between the measurement area. To do this, a signal of +24VDC must be applied by the machine at input "2nd inquiry" (PIN 4).

By means of this function, it is possible to check for proper sheet overlap at the machine intake. If only one sheet is present in the measurement area at the point in time the inquiry is made, a "high" signal is output at the output "2nd sheet missing" (PIN 14).

The output signal is cleared following the next inquiry which shows a correct second sheet. Alternatively, the input "activation" can be switched off briefly.

A missing second sheet will not block the VDB 14B. The sheet testing operation can be continued without clearing the output "2nd sheet missing".

## 6.6 Evaluation process

The evaluation on double sheets can be performed with the VDB 14B using two different processes.

The **edge evaluation** process can be thought of as the standard process.

The **window evaluation** process is an aid used to improve sheet movement for critical papers or print media.

The window and edge evaluation processes are controlled by the state of the control input PIN 9. The state of the input is detected upon activation of the VDB 14B. Later changes at the input are not taken into consideration until the next activation.

### ***Edge evaluation***

When input PIN 9 is activated ("high" signal), edge evaluation is used as the evaluation process.

As soon as a positive edge is present at input "1st inquiry" (PIN 3), the VDB 14B checks for a double sheet. The result of this inquiry is passed on immediately to the double sheet output (PIN 11).

### ***Window evaluation***

Window evaluation improves sheet movement, particularly for inhomogeneous materials. To activate window evaluation, a "low" signal must be present at PIN 9.

Edge evaluation, which is used in most cases, may lead to switching errors caused by double sheet detection when inhomogeneous materials are used. If a positive edge is queried at a inhomogeneous position in the material, a double sheet may be output. Window evaluation typically results in improved sheet movement.

During a window (negative cam at input PIN 3), the VDB 14B continuously measures the status of the sheets by means of the ultrasonic sensors. If a single sheet is detected within this window, this means that two sheets do not lie within the control area. At the end of the negative cam or of the window area, no double sheet signal is output.

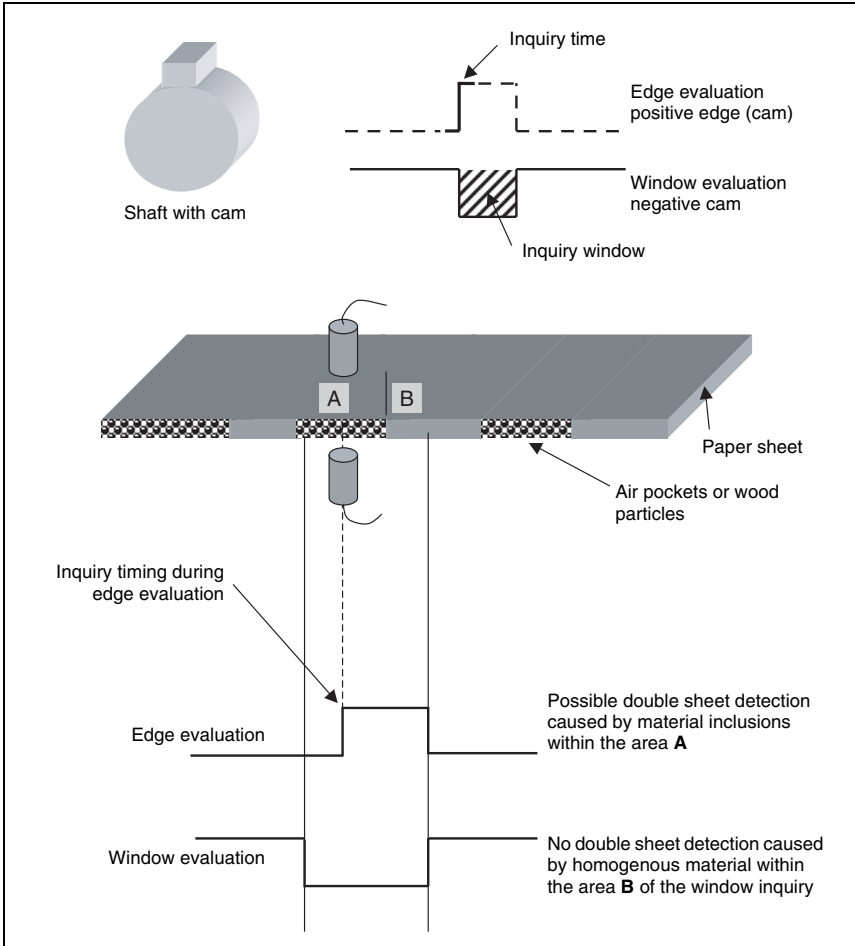

Figure 6.1: Evaluation process

## 7 Interfaces

The VDB 14B evaluation unit of the double sheet testing unit has two sockets at which various interface signals can be picked up. All GNDs of the various interfaces are connected to one another.

### 7.1 Serial interface

The serial interface is located on the lower right-hand side of the amplifier and is labelled with the following symbol:



Figure 7.1: Interface symbol

This interface can be used to load a new firmware version into the double sheet testing unit. This process must only be performed by authorised personnel.

#### Assignments of the serial interface

Function	Signal	Pin No.	Pin layout
+U <sub>B</sub>	+5VDC	1	
ground	GND	2	
transmit data	TXD	3	
receive data	RXD	4	
download MOSI	MOSI	5	
download MISO	MISO	6	
download SCK	SCK	7	
download RESET	RESET	8	

Table 7.1: Assignments of the serial interface

## 7.2 Analogue interface

In order to perform measurements with the system during machine operation, the values for the sensor amplifiers were moved to socket **X1**. All signals are available as analogue values in the range from 0 ... 12V at this socket.

### *Assignments of the analogue interface*

Function	Signal	Pin No.	Pin layout
capacitive sensor no. 3	Out Cap 3	1	
ground	GND	2	
ultrasonic sensor double sheet 1	US DB 1	3	
ultrasonic sensor single sheet 1	US EB 1	4	
ultrasonic sensor double sheet 2	US DB 2	5	
ultrasonic sensor single sheet 2	US EB 2	6	
capacitive sensor no. 1	Out Cap 1	7	
capacitive sensor no. 2	Out Cap 2	8	

Table 7.2: Assignments of the analogue interface X1



### **Attention!**

*No electrical isolation exists between the analogue interface and the VDB 14B*

*Damage to the measurement device or to the VDB 14B caused by improper handling during measurements cannot be excluded.*

## 8 Error messages (flashing)

Critical errors in the VDB 14B evaluation unit are indicated on the two 7 segment displays with **two flashing digits**.

The error numbers and the corresponding errors are listed in the following table:

<b>Error no. (flashing)</b>	<b>Description</b>
<b>00</b>	Device internal error.
<b>01</b>	Calibration is not possible. The material is too thick (applies only to capacitive sensor in the 1/2 sheet mode).
<b>02</b>	Calibration is not possible. The measurement value of the ultrasonic sensors was too low (too strongly dampened).
<b>03</b>	Device internal error.
<b>04</b>	Calibration is not possible. The material is too thick (applies only to capacitive sensors in the 2/3 sheet mode).
<b>05</b>	Device internal error.
<b>30</b>	During the self test, an interference caused by extraneous sound was detected.
<b>31</b>	During the self test, a sheet was detected between the ultrasonic sensors. Possible causes: Ultrasonic sensors not connected or defective.
<b>32</b>	During the self test, a sheet was detected between the ultrasonic sensors. Possible causes: Ultrasonic sensors not connected or defective.
<b>33</b>	During the self test, an insufficient signal was detected at the ultrasonic receiver. Possible causes: Ultrasonic sensors not aligned correctly, sheet between the sensors, poor connector contact or defective ultrasonic sensors.
<b>34</b>	Device internal error.
<b>35</b>	Calibration is not possible. The material is too thick for ultrasonic sensing.
<b>36</b>	Calibration is not possible. The material is too thin for ultrasonic sensing.
<b>40 ... 59</b>	Internal device error.
<b>60</b>	Measurement value of the capacitive sensor during calibration too low (high amplification).
<b>61</b>	Measurement value of the capacitive sensor during calibration too low (low amplification).

Table 8.1: Error messages

<b>Error no. (flashing)</b>	<b>Description</b>
<b>62</b>	Measurement value of the capacitive sensor during calibration too high (high amplification).
<b>63</b>	Measurement value of the capacitive sensor during calibration too high (low amplification).
<b>64</b>	Material during 1st inquiry too thick (applies only to capacitive sensor).
<b>69</b>	Device internal error.
<b>70</b>	With the 1st inquiry in 2/3 sheet mode with 2 sheets, two are expected, however only one was detected. Cause could be e.g. an irregular overlap flow.
<b>71</b>	With the 1st inquiry in 2/3 sheet mode with 2 sheets, two are expected, however no sheet was detected.
<b>72</b>	Device internal error (3/4 mode).
<b>73</b>	Device internal error (3/4 mode).
<b>74</b>	Device internal error (3/4 mode).
<b>75</b>	Device internal error (3/4 mode).
<b>76</b>	Combined preselection of 2/3 sheet mode and ultrasonics. This is not permitted. The capacitive sensor must be selected (PIN 7).
<b>77</b>	No adjustment performed prior to the calibration. Possible causes: The capacitive sensor was not adjusted following replacement or height adjustment of a VDB 14B or sensor. The warm-up phase of approx. 15 min. for the DB 14 K during initial adjustment was not adhered to. The pulse sequence (12 pulses) for adjustment did not arrive at the VDB 14B. During the basic adjustment, paper was underneath the DB 14 K.
<b>80</b>	No adjustment performed prior to the calibration.
<b>81</b>	The control voltage from the capacitive sensor is too low. The sensor is too close to the opposing plate.
<b>82</b>	The control voltage from the capacitive sensor is too high. The sensor is not connected or is too far from the opposing plate.
<b>83</b>	Capacitive sensor not adjustable (low amplification level). Check distance of the capacitive sensor to the grounding plate.
<b>84</b>	Capacitive sensor not adjustable (high amplification level). Cause could be e.g. long distance to the counter electrode.
<b>85</b>	Reception signal of the ultrasonic sensors too weak. Sensors defective or not aligned or sheet between the sensors.
<b>86</b>	Adjustment of the capacitive sensor was not successful. No calibration is possible.
<b>87</b>	After applying the operating voltage, the measurement path of the capacitive sensor was not clear. Remove printed material between the sensors!

Table 8.1: Error messages



<b>Error no. (flashing)</b>	<b>Description</b>
88	With activation ON, the measurement path was not clear.
89	With activation ON, the preselected values do not match the current state. Clear measurement path.
90	After applying the operating voltage, the measurement path of the ultrasonic sensors was not clear. Possible cause: Printed material between the sensors or sensors not connected. Stored reference value will be lost!
91	During the self test, it was determined that the signal of the ultrasonic sensors is too low when the measurement path is clear.
92	During the self test, it was determined that the signal of the capacitive sensor is not in the valid range (without paper).
93	During the self test, it was determined that the switching of the amplifier of the capacitive sensor does not function.
94	During the self test, it was determined that the signal of the capacitive sensor is not in the expected range (without paper, high amplification). The cause could be that adjustment was not performed following mounting or the position of the capacitive sensor was changed. This error message also appears if the ultrasonic sensors were not adjusted following delivery. If this error no. occurs relatively frequently, there is no defect; rather, the sensor is signalling that the environmental conditions for the capacitive sensor have changed (humidity, temperature etc.). <b>Recommendation: During work with the capacitive sensor, calibration on the printed material should be performed each time the supply voltage is switched on.</b>
95	After conclusion of the self test (3min. warm-up phase), the signal of the capacitive sensor was not in the expected range. For measures, see error no. 94.
99	Device internal error.

Table 8.1: Error messages



**Notice!**

*The error message (flashing 7 segment display) disappears as soon as a pulse is applied at the calibration input (PIN 6) or at the activation input (PIN 5).*

### ***Troubleshooting when switching on***

When voltage is applied to the VDB 14B evaluation unit, the controller performs a self test. This lasts approx. 10 seconds. Immediately after applying the voltage, all segments of the 7 segment display illuminate, i.e. including the two dots as well as all three yellow/green/red LEDs.

After this self test has been performed without error, only the green LED and the respective element of the 7 segment display remain illuminated (depending on the state of activation of one of the inputs).

### ***Other***

The decimal point of the right-hand 7 segment display (control inputs) indicates the amplifier stage currently selected by the VDB 14B for the capacitive sensor. If the point is illuminated, the amplification is high.

The decimal point of the left-hand 7 segment display (control outputs) indicates device-internal information about the 2/3 sheet mode of the VDB 14B.

If the VDB 14B is adjusted for operation with a DB 14 K capacitive sensor, **it may take up to 3min. after applying the supply voltage before the VDB 14B is ready for operation.** The non-ready state after power-on is indicated by the rotating bar in the 7 segment display.

9 Dimensioned drawings

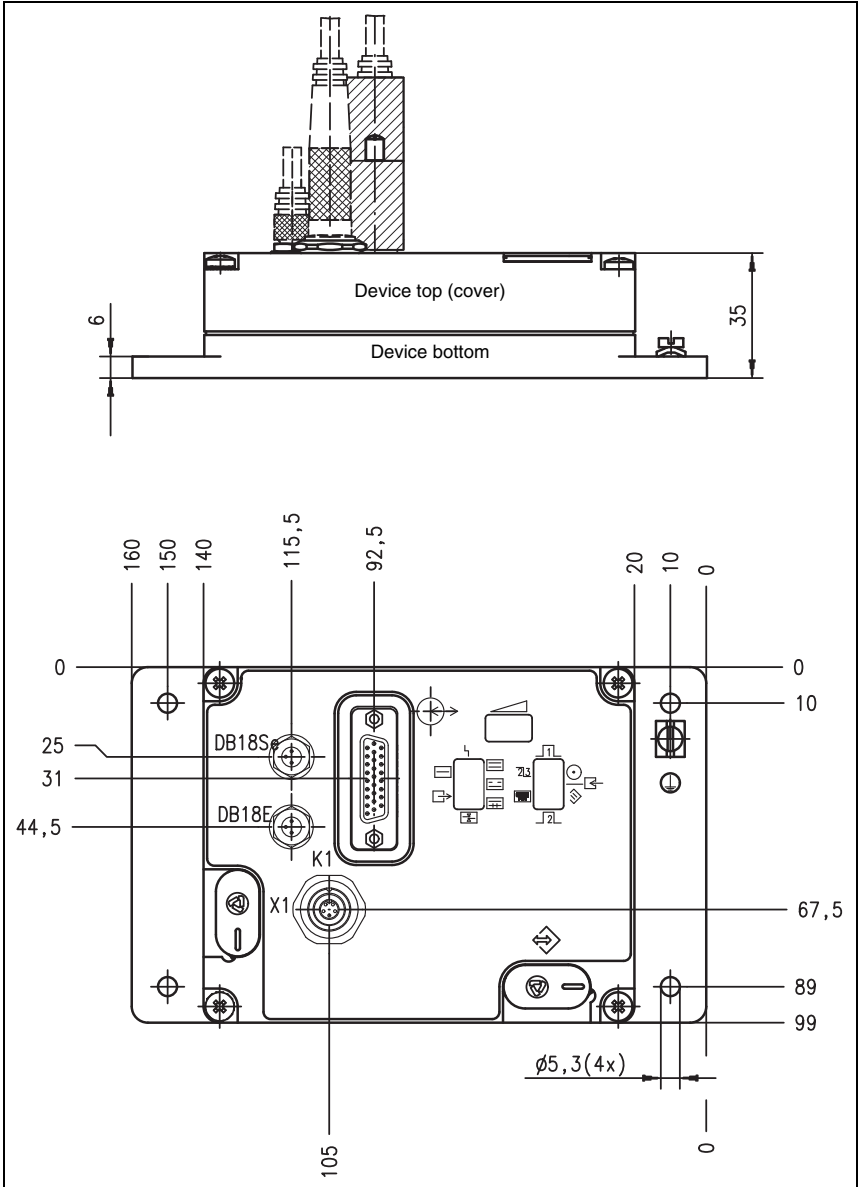

Figure 9.1: Dimensions of the VDB 14B evaluation unit

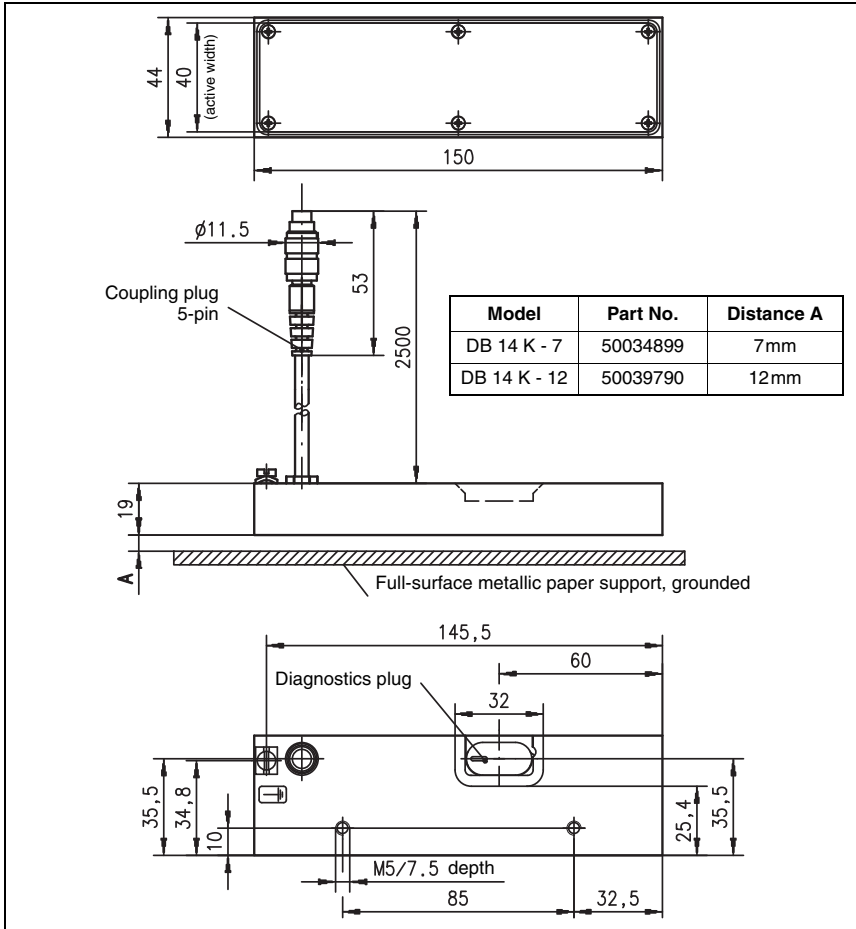

Figure 9.2: Capacitive sensor DB 14 K

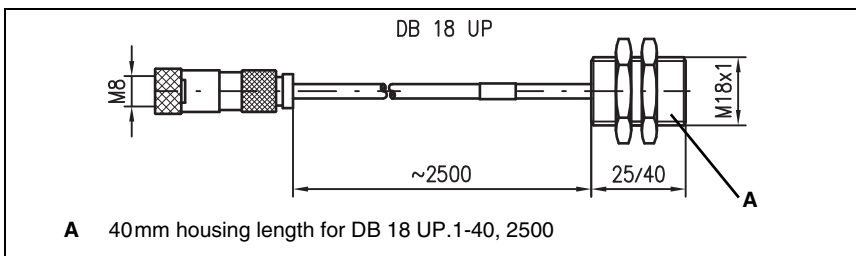

Figure 9.3: Ultrasonic transducer DB 18 UP

## 10 Specifications

Specifications for the system of the DB 14B double sheet testing unit

**Manufacturer** Leuze electronic GmbH + Co. KG  
In der Braike 1, D-73277 Owen/Teck

**Model** DB 14B, double sheet testing unit

*Evaluation unit VDB 14B/4 (PNP) and VDB 14B/2 (NPN)*

### Electrical data

Operating voltage $U_B$	18 ... 30VDC (incl. residual ripple)
Residual ripple	$\leq 15\%$ of $U_B$
Power consumption	max. 8.5W at 24VDC, idle operation
Inputs	24VDC opto-decoupled, $R_{in}$ approx. 5k $\Omega$
Pulse length	min. 100ms
Outputs	PNP (NPN) transistor outputs
Output current	max. 100mA
Signal voltage high/low	$\geq (U_B - 2 V) / \leq 2 V$

### Timing

Measurement duration, double sheet	approx. 2ms
Reaction time to 1st inquiry	$\leq 2$ ms (time until output "Double sheet detected" switches)
Delay before start-up	$\leq 2$ min. for DB 18 UP, $\leq 15$ min. for DB 14 K

### Interfaces

RS 232	for downloading new firmware and for visualising the measurement values on a separate PC with special software
Analogue interface X1	analogue signals 0 ... 12VDC of the ultrasonic sensors and the capacitive sensor

### Indicators

Yellow LED	signal level DB 18 UP
Green LED	signal level DB 18 UP
Red LED	without function
Two 7 segment displays	states of the control inputs and of the control outputs

### Mechanical data

Housing	aluminium
Weight	450g
Colour	black
Connection type	machine interface: 26-pin SUB-D connector sensors: 3-pin and 5-pin connectors

## Environmental data

Ambient temp. operation/storage	0 ... +40°C / -20 ... +70°C
Air humidity	max. 50% rel. humidity, non-condensing
Protective circuit <sup>1)</sup>	2,3
VDE safety class	III
Protection class	IP 40, IP 54 is possible using a special hood with integrated SUB-D connector
Standards applied	IEC 947-5-2

## Sensors

### Ultrasonic sensors DB 18 UP

Operating range	20 ... 40mm
Ultrasonic frequency	200kHz ±2%
Ultrasonic lobe	12° opening angle
Housing	brass, nickel-faced
Weight	30g
Protection class	IP 65
Connection type	M8 connector, 3-pin, with 2.5m cable

### Capacitive sensor DB 14 K - 7

Nominal distance	7mm
Measurement range	150 ... 800g/m <sup>2</sup> in 1/2 sheet mode, 150 ... 560g/m <sup>2</sup> in 2/3 sheet mode
Reaction time	25ms (settling time before a sheet change is detected)
Housing	aluminium
Weight	80g
Protection class	IP 65
Connection type	5-pin connector, with 2.5m cable

### Capacitive sensor DB 14 K - 12

Nominal distance	12mm
Measurement range	400 ... 2400g/m <sup>2</sup> in 1/2 sheet mode, 400 ... 1600g/m <sup>2</sup> in 2/3 sheet mode
Reaction time	25ms (settling time before a sheet change is detected)
Housing	aluminium
Weight	80g
Protection class	IP 65
Connection type	5-pin connector, with 2.5m cable

1) 2=polarity reversal protection, 3=short-circuit protection for all outputs

## 11 Maintenance

### 11.1 General maintenance information

The DB 14B double sheet testing unit does not normally require any maintenance from the operator. It is, however, recommended that the adjustment described in chapter 5.4 be performed once per year. The maximum performance reserve is thereby achieved.

#### **Cleaning**

↳ *Clean the soiled transmitter and receiver of the ultrasonic sensors with a soft cloth.*



#### **Attention!**

*Do not use aggressive cleaning agents such as thinner or acetone for cleaning the device.*

### 11.2 Repairs and maintenance

Repairs to the device must only be carried out by the manufacturer.

↳ *Contact your Leuze distributor or service organisation should repairs be required. The addresses can be found on the inside of the front cover of these operating instructions.*











## 12 Appendix: 2/3 sheet mode

















The DB 14B double sheet testing unit can, under certain conditions, also be operated in the 2/3 sheet mode. To do this, the following conditions must be met:







1. The capacitive sensor must be connected and the double sheet testing unit must be adjusted. The capacitive sensor must be preselected.
2. The control input "sheet mode changeover" (PIN 8) on 1/2 sheet or 2/3 sheet scanning must be set to "high". 2/3 mode is then preselected. The sheet mode must be preselected before the calibration is performed.
3. The calibration of the DB 14B double sheet testing unit in 2/3 sheet mode is performed on the first sheet and is only performed manually. The 2nd sheet is calibrated automatically as the first overlap is fed in.
4. The control input "2nd inquiry" (PIN 4) should be activated. Only then can drift and environmental influences be compensated for. Sensing without the 2nd inquiry is also possible, however, compensation of drift and environmental influences is omitted. In this case, the system functions with reduced performance reserve.
5. Appropriate values are present at the control output "sheet mode changeover status" (PIN 10):  
"low" signal → 1/2 sheet mode  
"high" signal → 2/3 sheet mode
6. The values of the overlap (number of sheets) are automatically adjusted during this calibration to the 2/3 sheet mode.
7. The evaluation "2nd sheet missing" is automatically adjusted in the 2/3 sheet mode.









### 12.1 Explanations of the calibration function





















Activa- tion	Inquiry	Calibration	Sheet movement	Effects / prerequisites	7 segment display + LEDs
<b>Adjustment of the sensors</b>					
		12x < 10s and pulse length 100ms  pulse/pause > 100ms		<b>Start basic calibration</b> (adjustment of the sensors) <b>Attention:</b> do not confuse with good sheet calibration on a sheet.	<b>7 segment display</b> shows capacitive alignment value. <b>LEDs</b> show level of ultrasonics.
		1x pulse length > 100ms		<b>Leaving adjustment mode</b> After setting the calibration pulse, wait at least 10s	<b>7 segment display</b> is switched to standard oper- ation
<b>Blank calibration</b>					
		1x pulse length > 100ms		The <b>blank calibration</b> can be used to quickly set an empty value. In this way, the auto- matic calculation can be per- formed explicitly (duration: at least 20s). The <b>outputs</b> are set as fol- lows: "ready+calibrated" = OFF <b>as long as input</b> "calibration" = ON, "Error" = ON.	
<b>Good sheet calibration in the 2/3 sheet mode</b>			 	2/3 sheet mode preselected via control input "sheet mode" = ON. Only "capacitive calibration" preselection is permitted.	
				Capacitive and ultrasonic sen- sors must have been free at least 30s prior to calibration.	

Activation	Inquiry	Calibration	Sheet movement	Effects / prerequisites	7 segment display + LEDs
		1x pulse length > 100ms		<p>If the <b>calibration was successful</b>, then the output "ready+calibrated" = ON.  <b>Error:</b>                      Adjustment not possible. In this case, as long as input "Calibration" = ON, the <b>outputs</b> are then set as follows: "Error" = ON, "Ready+calibrated" = OFF</p> <p><b>Attention:</b> the condition for adjustment can be fulfilled through excessive calibration in too short a period of time!</p>	In the event of an error, the error codes flash in the display
				Clear ultrasonic sensors.	
<b>Semi-automatic calibration in 2/3 sheet mode</b>				<p>Good sheet calibration performed in the 2/3 sheet mode (see above).                      2/3 sheet mode preselected via control input "sheet mode" = ON.                      VDB 14B capacitively calibrated, i.e. control output "ready+calibrated" = ON.</p>	
				Ultrasonic sensors must be clear.	
				Pick-up on and still no sheet under the sensors.	
				Pick-up on and still no sheet under the sensors.	
				<p>Capacitive and ultrasonic sensors completely covered with only one sheet at the time the inquiry is made.</p> <p>Inquiry only on 1st sheet. With 2 sheets, output "double sheet detected" set.</p>	



Activa- tion	Inquiry	Calibration	Sheet movement	Effects / prerequisites	7 segment display + LEDs
				<p>At time the second inquiry made, 2 sheets are expected. With only one measured sheet, the output "2nd sheet missing" is set, otherwise it is reset.</p>	
				<p>The 2nd sheet is automatically calibrated here.                  A second sheet is expected (the calibration value must be greater than the measurement value for 1.5 sheets and less than the measurement value for 2.5 sheets).                  If the capacitive calibration was successful, the output "double sheet detected (overlap)" is reset.</p> <p><b>Error:</b>                  Ultrasonic sensors covered and capacitive measurement value &gt; 2.5 sheets:                  Output "double sheet detected" = ON.</p> <p>Ultrasonic sensors covered and capacitive measurement value &lt; 1.5 sheets:                  No reaction, but renewed waiting for start of overlap (1 sheet). As a result, the single sheet being withdrawn may partially cover the capacitive and/or ultrasonic sensor.</p> <p>Ultrasonic sensors not covered or ultrasonic sensors not covered in the previous 1st inquiry and now in the next 1st inquiry two sheets are under the sensors, i.e. the status which is evaluated as an inquiry on the 1st sheet is:                  output "Double sheet detected" = ON.</p> <p><b>Note:</b> When restarting in the case of an error, set input "Activation" = OFF and back to = ON and repeat the semi-automatic calibration with the 1st inquiry on one sheet to restart.</p>	

Activa- tion	Inquiry	Calibration	Sheet movement	Effects / prerequisites	7 segment dis- play + LEDs
				<p>Printing on (inquiry missing for 2nd sheet). Output "double sheet detected (overlap)" set. If the third sheet is missing, the output "2nd sheet missing" is set.</p>	
				<p>Printing on (inquiry on double sheets). The output "double sheet detected (overlap)" is reset. With 3 sheets, the output "double sheet detected" is set.</p>	







### 12.2 Error case A: Multiple inquiries on the first sheet or multiple single sheets before start of overlap

Activa-tion	Inquiry	Calibration	Sheet movement	Effects / prerequisites	7 segment display + LEDs
Semi-automatic calibration in 2/3 sheet mode				<p>Good sheet calibration performed in the 2/3 sheet mode (see above).                  2/3 sheet mode preselected via control input "sheet mode" = ON.                  VDB 14B capacitively calibrated, i.e. control output "ready+calibrated" = ON.</p>	
				<p>First inquiry on the 1st sheet. Output "double sheet detected (overlap)" is not set.</p>	
				<p>First inquiry on the 1st sheet. Output "double sheet detected (overlap)" is not set. No reaction, but renewed waiting for start of overlap (1 sheet). As a result, single sheets are also possible on the feeder platform.</p>	
				<p>First inquiry on the 2nd sheet. Output "double sheet detected (overlap)" is <b>set prior to the first inquiry and reset after the inquiry.</b></p>	
				<p>First inquiry on the 2nd sheet. Output "double sheet detected (overlap)" is not set.</p>	
				<p>As before.</p>	
				<p>First inquiry on the 2nd sheet. Output "double sheet detected (overlap)" is set. Output "double sheet detected" is set.</p>	



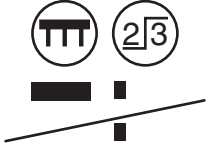











### 12.3 Error case B: Double sheet on inquiry of the first sheet

Activa-tion	Inquiry	Calibration	Sheet movement	Effects / prerequisites	7 segment dis-play + LEDs
				First inquiry on the 1st sheet. Output "double sheet detected (overlap)" is set. Output "double sheet detected" is set.	













### 12.4 Error case C: Double sheet during calibration on the second sheet

Activa-tion	Inquiry	Calibration	Sheet movement	Effects / prerequisites	7 segment dis-play + LEDs
				First inquiry on the 1st sheet. Output "double sheet detected (overlap)" is not set.	
				First inquiry on the 2nd sheet. Output "double sheet detected (overlap)" is set. Output "double sheet detected" is set.	

12.5 Error case D: One or more single sheets with subsequent double sheet at start of overlap

Activa- tion	Inquiry	Calibration	Sheet movement	Effects / prerequisites	7 segment display + LEDs
Semi-automatic calibration in 2/3 sheet mode				<p>Good sheet calibration performed in the 2/3 sheet mode (see above). 2/3 sheet mode preselected via control input "sheet mode" = ON. VDB 14B capacitively calibrated, i.e. control output "ready+calibrated" = ON.</p>	
				<p>First inquiry on the 1st sheet. Output "double sheet detected (overlap)" is not set.</p>	
				<p>First inquiry on the 1st sheet. Output "double sheet detected (overlap)" is not set. No reaction, but renewed waiting for start of overlap (1st sheet); thus single sheets are possible on the feeder platform.</p>	
				<p>First inquiry on the 2nd sheet. The output "double sheet detected (overlap)" is <b>set before the query</b>. The output "double sheet detected" is set, the calibration (manually on a good sheet) is retained.</p>	
				<p>Output "double sheet detected" remains set.</p>	

## 12.6 Symbol legend

Symbol	Description
	Activation = OFF.
	Activation = ON.
	Multiple passes.
	1st inquiry, may be capacitive or ultrasonic sensing.
	2nd inquiry, may be capacitive or ultrasonic sensing.
	Preselection 1/2 sheet mode, capacitive sensing for 2 sheets (double sheet).
	Preselection 2/3 sheet mode, capacitive sensing for 3 sheets (double sheet).
	Preselection capacitive sensing. The ultrasonic sensors are only used for first sheet recognition.
	Ultrasonic sensors
	Ultrasonic sensors with capacitive sensor.
	Inquiry on one sheet.
	Inquiry on two sheets.
	Inquiry on three sheets.



Symbol	Description
	Symbolises a single sheet at multiple inquiries, which is the case in 2/3 sheet scanning. A single sheet undergoes two 1st inquiries in this case.

### 12.7 Critical cases in the overlap flow with 2/3 sheet scanning

Requirement for the following cases: in the event of a **missing sheet**, the input "Pickup ON" or "Sheet feeder" does not switch off.

#### Case 1: double sheet detected

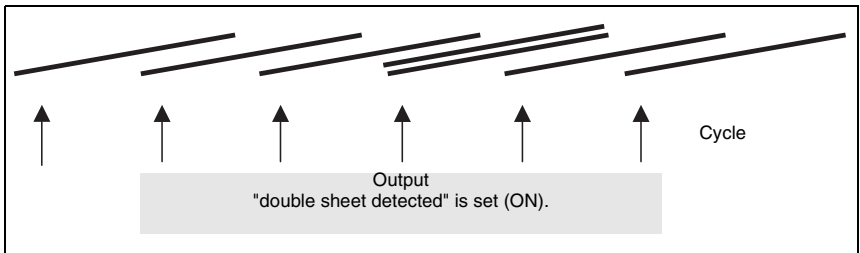

Figure 12.1: Critical case 1

#### Case 2: double sheet is detected 1 cycle later

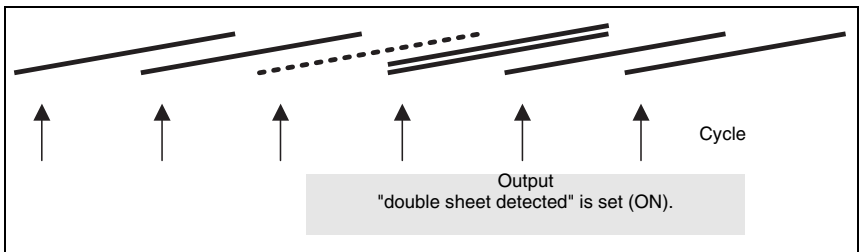

Figure 12.2: Critical case 2

**Case 3: double sheet in overlap not detected**

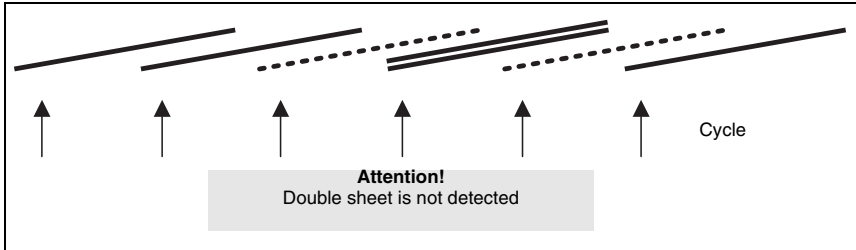

Figure 12.3: Critical case 3

**Case 4: after the overlap has passed, double sheet is detected only by at least one blank 1st inquiry**

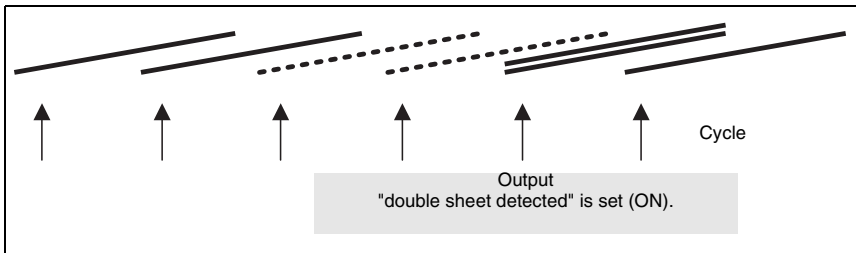

Figure 12.4: Critical case 4