

L49C MOSFET

Throughbeam photoelectric sensors

Dimensioned drawing

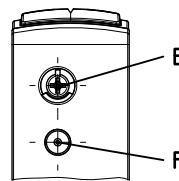
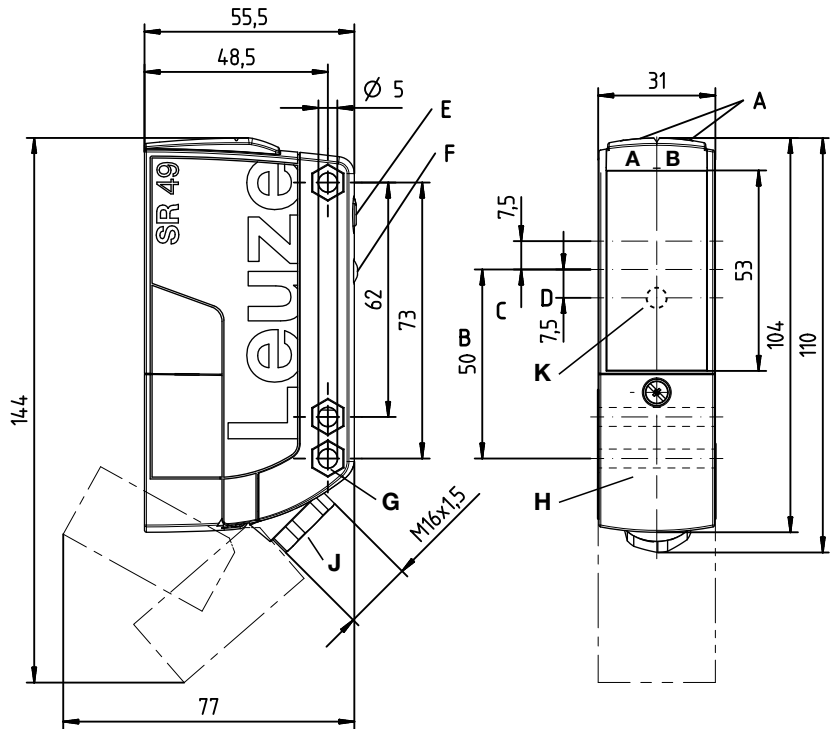

- A_A** Green indicator diode
- A_B** Yellow indicator diode
- B** Optical axis
- C** Receiver
- D** Transmitter
- E** Sensitivity adjustment
- F** Teach button for light/dark switching / time module activation
- G** Countersinking for SK nut M5, 4.2 deep
- H** Connection compartment with spring terminals
- J** Cable entry with M16x1.5 screw fitting for $\varnothing 5 \dots 10$ mm
- K** Yellow indicator diode
 Transmitter: active/not active
 Receiver: signal/no signal

Electrical connection

Transmitter
DC/AC

Receiver
DC/AC

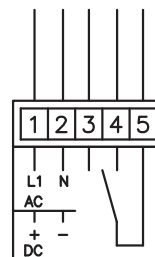
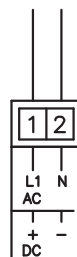

Pin 3 = nc (not connected)

Wire color of connecting cable

Pin	Color
1	BR / BN
2	BL / BU
3	WS / WH
4	GR / GY
5	SW / BK



150m

20 - 250 V
AC / DC

- Throughbeam photoelectric sensors with large operating range and high performance reserve in red light and infrared light versions
- Robust plastic housing, degree of protection IP 67 and IP 69K for universal, industrial application
- All-mains design 20 ... 250VAC/DC with MOSFET semiconductor switching output (potential-free)
- Sensitivity adjustment and delay before start-up for optimal adaptation to the application
- Light/dark switching and time module activation via teach button for time-saving integration in existing evaluation environment:
- Time-saving, exact alignment through additional, highly visible display
- Space-saving installation thanks to front access to the connection compartment
- Extremely time-saving connection by means of spring terminals (up to 1.5mm²)
- Optics heating



Accessories:

(available separately)

- Mounting systems (BTU 460, BT 96, BT 96.1, BT 450.1-96)
- Alignment aid SAT 5

en 02-2015/08 50128465-01

We reserve the right to make changes • DS_L49CUCM4_en_50128465_01.fm

Specifications

Optical data	L49C...	L49CI...
Typ. operating range limit ¹⁾	0 ... 150m	
Operating range ²⁾	0.5 ... 120m	
Light source	LED (modulated light)	
Wavelength	630nm (red light)	860nm (infrared light)
Timing		
Switching frequency	150Hz	
Response time	3.3ms	
Delay before start-up	≤ 300ms	
Electrical data		
Operating voltage U _B	20 ... 250VAC, 50/60Hz	
	20 ... 250VDC	
Power consumption	≤ 1.5VA	
Switching output ³⁾	MOSFET semiconductor switching output (NO)	
Function	NO contact	
MOSFET switching voltage	250VAC/DC	
MOSFET switching current	250VAC, 0.4A/30VDC, 0.4A	
MOSFET switching power	100VA, cosφ=1	
Sensitivity	adjustable	
Indicators		
Green LED	ready	
Yellow LED	light path free	
Yellow LED, flashing	light path free, no performance reserve	
Yellow LED (behind lens cover)	transmitter: active/not active	
	receiver: signal/no signal	
Yellow LED (behind lens cover), flashing	receiver: signal, performance reserve limited	
Mechanical data		
Housing	polycarbonate	
Optics cover	plastic	
Weight	150g	
Connection type	spring terminals, max. wire cross section 1.5mm ² cable 2000mm, 3/5 x 0.5mm ²	
Environmental data		
Ambient temp. (operation/storage)	-40°C ... +60°C/-40°C ... +70°C	
Protective circuit ⁴⁾	1, 2, 3	
VDE safety class ⁵⁾	II, all-insulated	
Degree of protection	IP 67, IP 69K ⁶⁾	
Light source	exempt group (in acc. with EN 62471)	
Standards applied	IEC 60947-5-2	
Options		
Switching function (teach level 1)	light switching (factory setting) or dark switching	
Time module (teach level 2)	active: dropout delay 500ms not active:no dropout delay (factory setting)	
Optics heating		
Current consumption	approx. 70mA at 20VDC	

Tables

0/0,5	120	150
-------	-----	-----

Operating range [m]
 Typ. operating range limit [m]

Diagrams

L49C... with red light

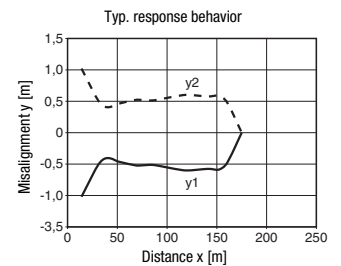

L49CI... with infrared light

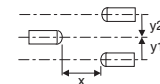
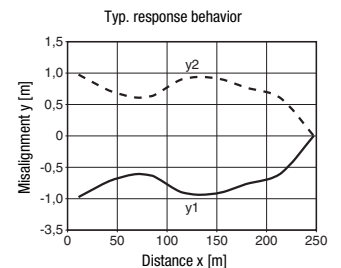

Remarks

Operate in accordance with intended use!

- ⚠ This product is not a safety sensor and is not intended as personnel protection.
- ⚠ The product may only be put into operation by competent persons.
- ⚠ Only use the product in accordance with the intended use.

L49C MOSFET

Throughbeam photoelectric sensors

Part number code

Transmitter	L	S	4	9	C	I	.	U	C	H						-	T	B
Receiver	L	E	4	9	C	I	.	U	C	H	1	/	M	4		-	T	B

Operating principle

LS Throughbeam photoelectric sensor, transmitter

LE Throughbeam photoelectric sensor, receiver

Series

49C 49C series

Light type

I Infrared light

free Red light

Operating voltage

UC 20 ... 250VAC/DC (all-mains design)

Equipment

H Optics heating

Setting (receiver)

1 Potentiometer, teach button (light/dark switching, time module activation)

Switching output (receiver)

TS Relay, normally closed contact/normally open contact (NC/NO)

M4 Low-impedance MOSFET semiconductor switching output, normally open contact (NO)

Connection technology

TB Terminal block - terminal compartment with spring terminals (5 x 1.5mm²)

free Cable 2000mm

Order guide

The sensors listed here are preferred types; current information at www.leuze.com.

All-mains designs with MOSFET semiconductor output

Designation

Part no.

		Designation	Part no.	
TRANSMITTER	Terminal compartment with spring terminals (5 x 1.5mm²)			
	Red light	LS49C.UC-TB	50127437	
	Infrared light	LS49CI.UC-TB	50127439	
	Red light, optics heating	LS49C.UCH-TB	50130462	
	Infrared light, optics heating	LS49CI.UCH-TB	50130463	
	Cable, cable length 2m			
	Red light	LS49C.UC	50127438	
	Infrared light	LS49CI.UC	50127440	
	RECEIVER	Terminal compartment with spring terminals (5 x 1.5mm²)		
		Red light	LE49C.UC1/M4-TB	50127443
Infrared light		LE49CI.UC1/M4-TB	50127447	
Red light, optics heating		LE49C.UCH1/M4-TB	50130465	
Infrared light, optics heating		LE49CI.UCH1/M4-TB	50130466	
Cable, cable length 2m				
Red light		LE49C.UC1/M4	50127444	
Infrared light		LE49CI.UC1/M4	50127448	

Transmitter/receiver combinations ¹⁾		TRANSMITTER		RECEIVER
Red light	Terminal connection	50127437	+	50127443
	Terminal connection, optics heating	50130462	+	50130465
	Connection cable	50127438	+	50127444
Infrared light	Terminal connection	50127439	+	50127447
	Terminal connection, optics heating	50130463	+	50130466
	Connection cable	50127440	+	50127448

1) Combinations of red-light devices and infrared-light devices are not possible; combinations of devices with terminal connection and devices with connection cable are possible if both devices are of the same light type

Teach procedure for sensor



Note

Factory setting: **light switching, time module not active**

Light/dark switching

Setting the switching behavior of the MOSFET output

Teach level 1	<p>Press teach button (2 to 7s) until both LEDs (green/yellow) flash synchronously. Release teach button – switchover is complete.</p> <p>The yellow LED then indicates the current setting of the switching output for 3s:</p> <p>ON = light switching = output between pin 4 and pin 5: normally open contact (NO)</p> <p>OFF = dark switching = output between pin 4 and pin 5: normally closed contact (NC)</p>	
----------------------	---	---

Activation/deactivation of the time module

Setting a dropout delay for the MOSFET output

Teach level 2	<p>Press teach button (7 to 12s) until both LEDs (green/yellow) flash alternately. Release teach button – activation/deactivation is complete.</p> <p>The yellow LED then indicates the current setting of the dropout delay for 3s:</p> <p>ON = time module not active = no dropout delay for the MOSFET output</p> <p>OFF = time module active = dropout delay for the MOSFET output: 500ms ¹⁾</p>	
----------------------	--	---

1) Additional models on request

Dropout delay: if the object is no longer present, the output switches with a time delay.