

IT 1452g

Hand-held bar code scanner with Bluetooth data transmission

en 01-2015/09 50130034



- Hand-held scanner for bar codes
- Transmission to base station via Bluetooth standard V2.1
- Large reading field for detecting high-contrast codes
- Robust trigger button
- Built-in decoder
- Indicator upon successful read
- RS 232, USB and PS/2 interface
- Operating temperature 0°C to 50°C



Accessories

- **TTL-RS 232 cable**
Part no. 50114517
- **PS/2 cable**
Part no. 50114519
- **USB cable, 3m**
Part no. 50114521
- **USB helix cable, 5m**
Part no. 50114523
- **Power supply unit**
Part no. 50114525

Dimensioned drawing

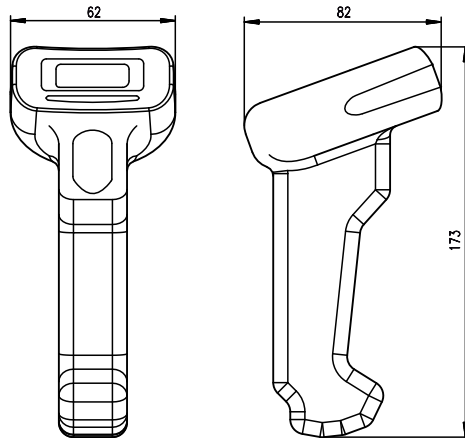

Hand-held scanner
IT 1452g 1D-2
with Bluetooth

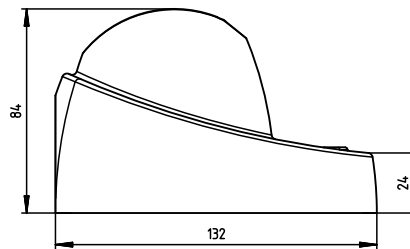

Bluetooth base station
Base for IT 1452

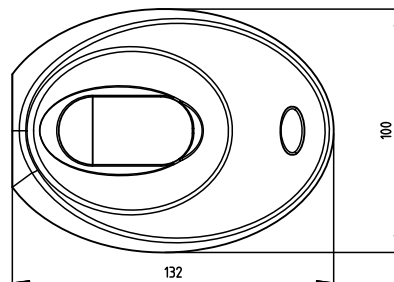

Electrical connection

for RS 232 cable

9-pin Sub-D	Signal	Base for IT 1452 RJ41
2	TXD	4
3	RXD	5
5	GND	3
7	CTS	6
8	RTS	8
9	5VDC	7

for USB cable

USB type A	Signal	Base for IT 1452 RJ41
1	5VDC	7
2	Data -	10
3	Data +	9
4	GND	3

for PS/2 cable

Mini DIN connector	Mini DIN socket	Signal	Base for IT 1452 RJ41
1	-	PC Data	4
2	2	NC	
3	3	GND	3
4	4	5VDC	7
5	-	PC Clock	5
6	6	NC	
-	1	KB data	8
-	5	KB clock	6

We reserve the right to make changes • DS_IT1452g_en_50130034.fm

Specifications

Electrical data	IT 1452g 1D-2	Base for IT 1452
Operating voltage U_B	3.7VDC internal battery	4.5 ... 5.5VDC
Power consumption		max. 5W @ 5VDC
Li-ion battery		
Capacity	2,000mAh	
Max. number of scans	40,000	
Max. operating time	14h at 1 scan/s	
Charging time at 9VDC	4.5h for complete charge following complete discharge	
Radio transmission		
Frequency	2.4 ... 2.4835GHz (ISM band)	
	frequency hopping, Bluetooth® V2.1, Class 2	
Typ. operating range	10m	
Transmission speed	up to 1 Mbit/s	
Interfaces		
Interface type	RS 232, PS/2 and USB	
Trigger	via button or serial command	
Types of codes		
Bar codes	2/5 Interleaved, Code 39, Code 128, Code 93, Codabar, UPC/EAN, Codablock, GS1 Databar	
Optical data		
Optical system	pixel array 640x480	
Symbol contrast	PCS 35% minimum	
Light source	integrated diffuse LED	
Read direction	omnidirectional, various tilt and rotational angles up to 45°	
Mechanical data	IT 1452g 1D-2	Base for IT 1452
Weight	approx. 210g	approx. 180g (without cable)
Dimensions	173x82x62mm	101x131x81mm
Shock resistance	30 falls from a height of 1.5m	50 falls from a height of 1m
Environmental data		
Ambient temp. (operation)	0°C ... +50°C	0°C ... +50°C
Ambient temp. (storage)	-40°C ... +70°C	-40°C ... +60°C
Relative humidity	0 ... 95% (non-condensing)	0 ... 95% (non-condensing)
Light source	exempt group (in acc. with EN 62471)	
Degree of protection	IP 42	IP 41
Certifications	IEC 60950-1 (US-19749-A1-UL)	

Tables

Remarks

Operate in accordance with intended use!

⚠ The product may only be put into operation by competent persons.

⚠ Only use the product in accordance with the intended use.

Ergonomically shaped hand-held scanner with integrated decoder for high-contrast codes.

Data transmission via configurable RS 232 interface.

Or keyboard-wedge operation via PS/2 or USB interface.

For a functional unit, an IT 1452g hand-held scanner and a Base for IT 1452 base station as well as a power supply unit and corresponding cable must be ordered.



Bluetooth is a trademark owned by Bluetooth SIG, Inc., U.S.A. and licensed to Honeywell.

Reading field

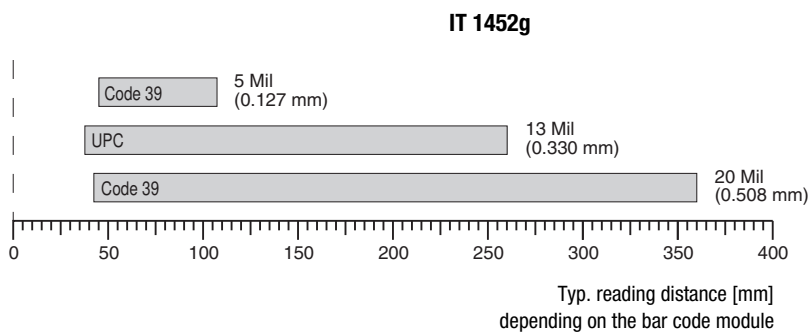

IT 1452g

Hand-held bar code scanner with Bluetooth data transmission

Order guide

Hand-held reader for bar codes (Standard Range)

IT 1452g 1D-2 with Bluetooth data transmission

Part no.

50130501

Base station for hand-held bar code scanner with Bluetooth data transmission

Base for IT 1452 with RS 232, PS/2 and USB interface

Part no.

50130499

Switching off the computer

Information on switching off and shutting down the connected computer - which must always be performed before connecting peripheral devices, such as a scanner - can be found in the appropriate operating instructions for your computer.

Connecting the base station

Shown in the adjacent figure are the locations for installing the cable on the base station. The individual installation steps are described in the following.

1. To secure the interface cable to the base station, proceed as follows: plug the RJ 41 connector into the socket on the bottom of the base station until the cable clicks into place.
2. Connect the interface cable to the appropriate connection socket on the computer.
3. You may need a power supply unit for supplying voltage if you would like to charge the hand-held scanner via the base station or use an RS 232 interface. Use the pin assignments (see "Electrical connection" on page 1) to select the appropriate cable for your application.
4. Connect the power supply unit to the power socket.
5. Use the code for the respective application to configure the hand-held scanner, see chapter "Parameterization".
6. Check the operational readiness of the scanner by pointing the scanning surface towards a flat surface and pulling the trigger. A green target line as well as the red illumination should now be visible. Now scan a sample label. The scanner emits an acoustic signal to confirm that the label has been read; if necessary, the data is now passed on to the computer.

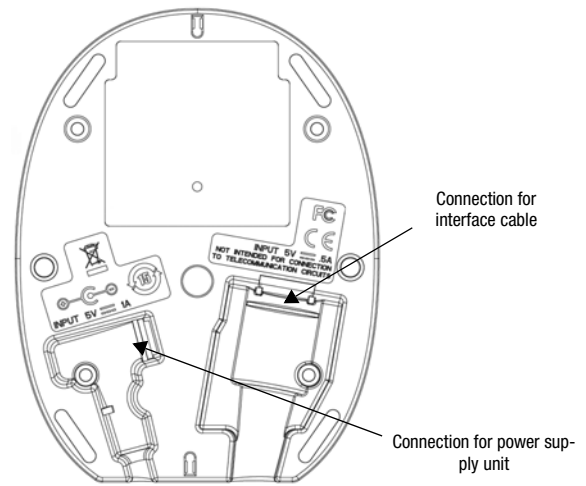

Parameterization

The hand-held scanner can always be configured using 2D-codes. To do this, the 2D-code must first be selected on the package insert and then the trigger actuated in order to read the code. The configuration is then immediately accepted and executed.

Several of the most important configurations are listed in the following.

A second option is to configure the hand-held scanner with the USB and RS 232 interfaces with the aid of the **EZ Config** PC program. You can download and install this program from our homepage at www.leuze.com.

The program can be used to make settings and transfer them to the hand-held scanner. The configuration can also be stored so that it can be reused at a later time.

More information can also be found in the user's guide.

The standard applications are described and summarized below.



Notice!

Additional information on the device and short instructions can be found on the Internet at www.leuze.com.

Resetting the IT 1452g to factory settings

To reset all parameters to factory settings, scan the adjacent bar code.



Attention!

All settings are lost!!!



Return the hand-held scanner to the base station to apply the settings. This procedure is concluded with acoustic confirmation signals.

You may then continue making settings or operation of the device.

Trigger

To activate the read process, a trigger signal is to be sent via the serial RS 232 interface or USB interface (COM port emulation only). The command is to be sent at the set baud rate, parity, and data and stop bits.

The command for activation is: **SYN T CR** ASCII decimal values: 022; 084; 013

To cancel read readiness, send a deactivation.

The command for deactivation is: **SYN U CR** ASCII decimal values: 022; 085; 013

Following a successful read operation, the hand-held scanner deactivates itself.

The second option is activation via the built-in trigger button.

Configuration for the Leuze standard protocol

Scan the adjacent 2D-code.

The hand-held scanner is set to the following transmission parameters:

RS 232 transmission with 9,600 baud, 8 data bits, 1 stop bit, no parity, prefix <STX>, postfixes <CR><LF>.

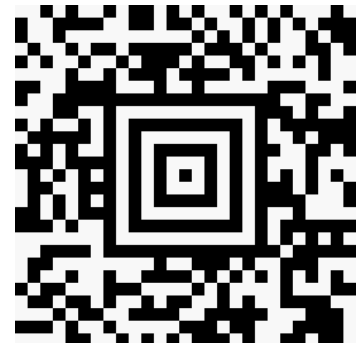

IT 1452g

Hand-held bar code scanner with Bluetooth data transmission

Connecting the IT 1452g to the serial PC interface

With TTL-RS232 cable (part no. 50114517)

Required parts:

- 1x IT 1452g 1D-2
- 1x 50130499 Base for IT 1452 base station
- 1x 50114517 KB 232-1 IT 190x
- 1x 50114525 Power supply unit

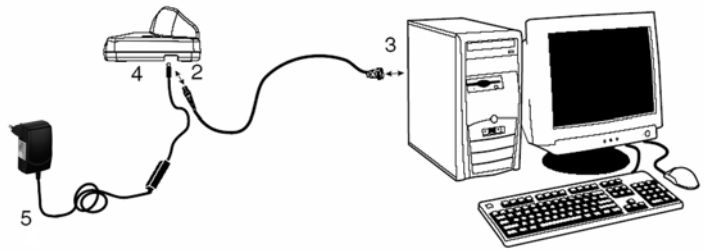

Notice!

Cable **KB 232-1 IT190x** (part no. 50114517) uses TTL-level (0V...5V) for data transmission. As an alternative to this, cable **KB 232-2 IT190x** (part no. 50115105) can be used. This cable works with the regular RS232 level (-12V...+12V) and therefore features a higher interference rejection. Both cables are connection compatible.

Procedure:

1. Switch off the PC.
2. Connect the interface cable to a free COM port (RS 232) on the computer (3) and to the base station (2).
3. Plug one end of the power supply unit cable into the base station (4) and the other end into a free power socket (5).



4. Switch the PC back on.

5. Scan the adjacent bar code.

The hand-held scanner is set to the following transmission parameters:

RS 232 transmission with 115,200 baud, 8 data bits, 1 stop bit, no parity, postfixes <CR><LF>.

6. Return the hand-held scanner to the base station to apply the settings. This procedure is concluded with optical confirmation signals (green LED on the base station).
7. If necessary, adjust the transmission parameters of the used COM port to those of the hand-held scanner.



Attention!

We recommend connecting the base station directly to a PC or to the MA 21 or MA 41... connection units. If connecting to other components, please note that a voltage level range of 0 ... +5V (TTL level) is maintained on the data lines!

Connecting the IT 1452g to the MA 2xxi

Required parts:

- 1x IT 1452g 1D-2
- 1x 50130499 Base for IT 1452 base station
- 1x 50115105 RS 232 cable
- 1x 50114525 Power supply unit
- 1x 50113397 KB JST-HS-300
- 1x Connection unit **MA 2xxi** for the respective fieldbus system:
 - 50112893 **MA 204i** for PROFIBUS or
 - 50112892 **MA 208i** for Ethernet or
 - 50112891 **MA 248i** for PROFINET

Procedure:

1. Insert the KB JST-HS-300 cable into the MA 2xxi.
2. Connect the interface cable to cable KB JST-HS-300.
Connect the interface cable and the power supply unit to the base station (see "Connecting the IT 1452g to the serial PC interface").
3. Scan the adjacent 2D code.
The hand-held scanner is set to the following transmission parameters:
RS 232 transmission with 9600 baud, 8 data bits, 1 stop bit, no parity, postfixes
<CR><LF>.
4. Return the hand-held scanner to the base station to apply the settings. This procedure is concluded with audible confirmation signals.



Connecting the IT 1452g to the MA 21

Required parts:

1x	IT 1452g 1D-2
1x 50130499	Base for IT 1452 base station
1x 50114517	KB 232-1 IT 190x
1x 50114525	Power supply unit
1x 50035421	KB 021 Z
1x 50030481	MA 21 100

Pin assignments KB021 Z:

Core color:	Signal	Terminal in the MA 21:
Brown	(RXD)	26
White	(TXD)	27
Blue	(GND)	28
Red	(VCC)	⊗
Black	(GND)	⊗
Bare (shield)	(PE)	21

Procedure:

1. Connect cable KB 021 Z to the MA 21... acc. to the above pin assignments.
2. Connect the interface cable to cable KB 021 Z. Connect the interface cable and the power supply unit to the base station (see "Connecting the IT 1452g to the serial PC interface").
3. Scan the adjacent 2D code.

The hand-held scanner is set to the following transmission parameters:

RS 232 transmission with 9,600 baud, 7 data bits, 1 stop bit, even parity, postfixes <CR><LF>.

4. Return the hand-held scanner to the base station to apply the settings. This procedure is concluded with acoustic confirmation signals.



Connecting the IT 1452g to the PS/2 interface

The operation of the hand-held scanner in keyboard emulation mode is described in this section. With this operating mode, a PC keyboard is emulated. The read data are written directly into the currently activated program. The data can thereby be further processed in all standard programs.

Required parts:

1x	IT 1452g 1D-2
1x 50130499	Base for IT 1452 base station
1x 50114525	Power supply unit
1x 50114519	KB PS2-1 IT 1902

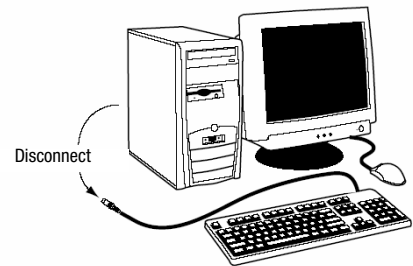

Procedure:

1. Switch off the PC.
2. Disconnect the keyboard.
3. Connect the cable for the base station between the keyboard and the PC.
4. Switch the PC back on.
5. Scan the 2D code shown below.
6. Return the hand-held scanner to the base station to apply the settings. This procedure is concluded with acoustic confirmation signals.

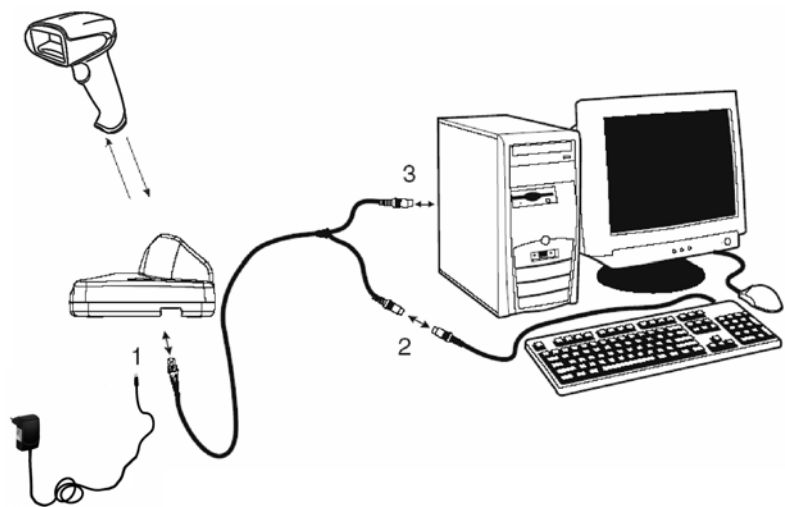

Notice!

To charge the hand-held scanner, the power supply unit must be plugged in and the hand-held scanner placed in the base station.



IT 1452g**Hand-held bar code scanner with Bluetooth data transmission****Connecting the IT 1452g to the USB interface (keyboard emulation)**

Operating the hand-held scanner in keyboard emulation mode on a USB port is described in this section. With this operating mode, a PC keyboard is emulated. The read data is written directly into the currently activated program. The data can therefore be further processed in all standard programs.

Required parts:

- 1x IT 1452g 1D-2
- 1x 50130499 Base for IT 1452 base station
- 1x 50114525 Power supply unit
- 1x 50114521 KB USB-1 IT190x (3m, straight)
- or
- 1x 50114523 KB USB-2 IT190x (5m, spiral)

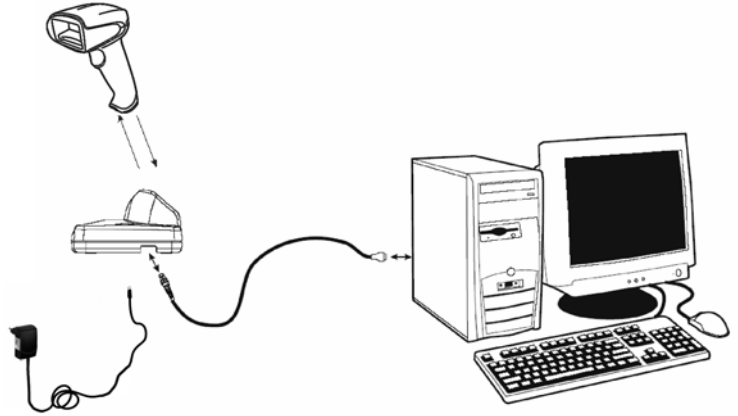
**Procedure:**

1. Connect the cable for the base station to a free USB port.
2. The scanner acknowledges this connection with a beep.
3. Scan the adjacent 2D code.

**Notice!**

To charge the hand-held scanner, the power supply unit must be plugged in and the hand-held scanner placed in the base station.



Connecting the IT 1452g to the USB interface (COM port emulation)

The operation of the hand-held scanner as a serial interface on a USB port is described in this chapter. With this operating mode, a COM interface is emulated. The read data are sent to a new COM interface. The drivers with which this COM interface is emulated can be downloaded from our homepage at www.leuze.com. Thus, the data can be processed further in programs which expect data via COM interfaces.

Required parts:

- 1x IT 1452g 1D-2
- 1x 50130499 Base for IT 1452 base station
- 1x 50114525 Power supply unit
- 1x 50114521 KB USB-1 IT190x (3m, straight)
- or
- 1x 50114523 KB USB-2 IT190x (5m, spiral)

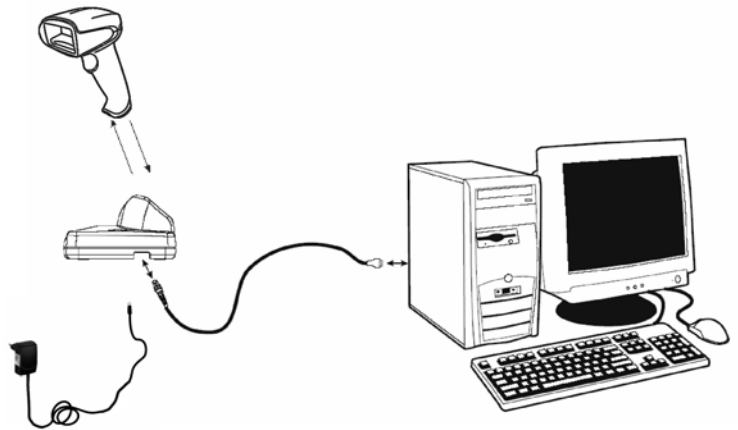

Procedure:

1. Install the USB serial driver (current version available at www.leuze.com).
2. Connect the cable for the base station to a free USB port.
3. The scanner acknowledges this connection with a beep.
4. Scan the adjacent 2D code.
5. Open a terminal program or your program for the serial interface, select the new COM port, and make the following settings: baud rate 38,400, 8 data bits, 1 stop bit, no parity, postfix <CR>.

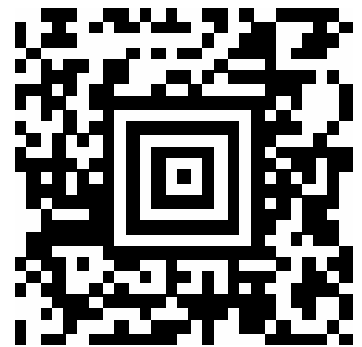

Notice!

To charge the hand-held scanner, the power supply unit must be plugged in and the hand-held scanner placed in the base station.