

en 02-2015/01 50126178

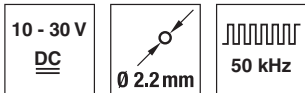

up to 1700mm **up to 450mm**



- Extremely short response time
- Two, large, easy-to-read displays for the simultaneous display of the signal value and the switching threshold
- Simple operation and easy-to-understand menu functions for optimum configuration
- Internal multiplex operation of up to six units
- Line teach or external transmitter activation
- Three different teach modes for fast sensor adjustment
- Switch for changing between light and dark switching
- One PNP or NPN switching output
- Indicator diode for operation and switching output
- Connection via M8 connector, cable or cable with M12 connector

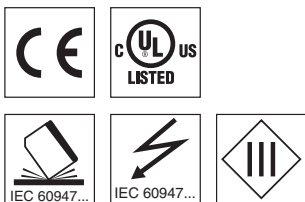

Accessories:

(available separately)

- Plastic fiber optics (KF, KFX)
- Glass fiber optics (GF)
- Ready-made cables (KB ...)
- Mounting device (BTU LV463)

Dimensioned drawing

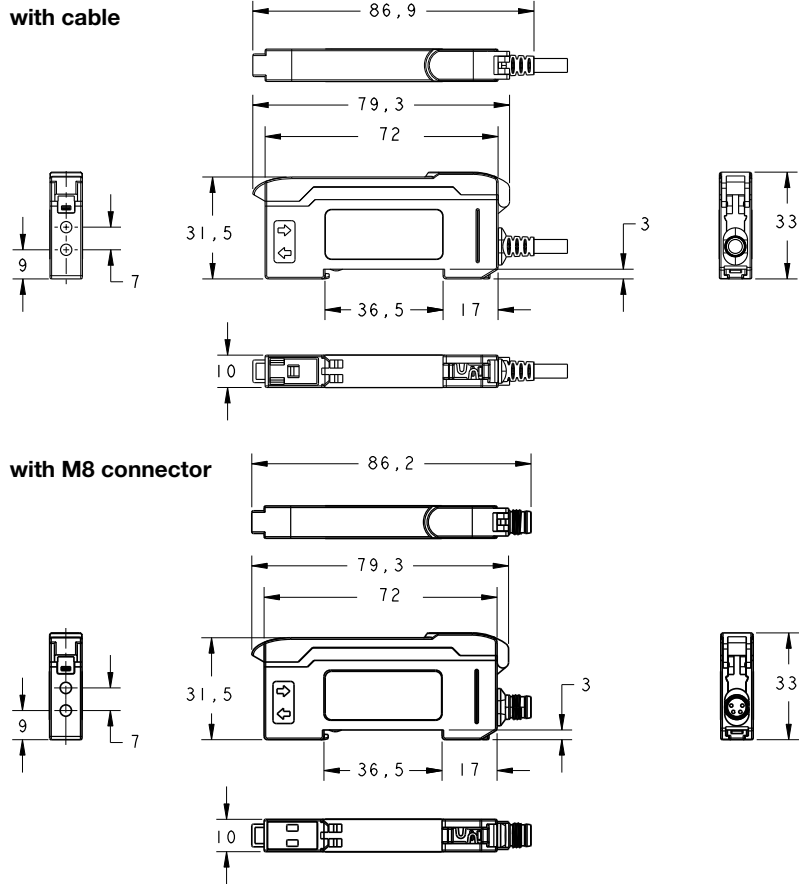

Mounting accessories

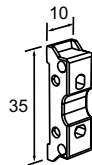

BTU LV463
Part no. 50120869

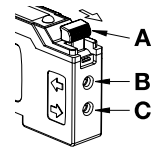

- A** Clamping lever for fiber optic cable (unlock in direction of arrow)
- B** Connection for fiber optics receiver
- C** Connection for fiber optics transmitter

Electrical connection

4-pin plug

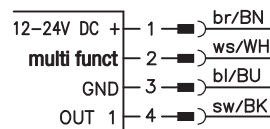

4-wire cable

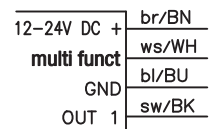

- multi funct:**
- OFF
 - Line teach
 - Activation input
 - Multiplex operation

Details → *Description of the subfunctions*

NOTE: Open lead wires must be connected to a terminal box.

We reserve the right to make changes • DS_LV463B_en_50126178.fm

Specifications

Optical data	Throughbeam principle	Scanning principle
Operating range/scanning range ¹⁾ Light source Wavelength	up to 1700mm LED (modulated light) 660nm (visible red light)	up to 450mm
Timing		
Delay before start-up	≤ 500ms	
	Signal range	
	Extra High Speed (XHS)	High Speed (HS)
Response time	10µs	15µs
Switching frequency ²⁾	50kHz	33kHz
Display area (digits)	0 ... 4000	0 ... 4000
	Speed (S)	Long Range (LR)
	0 ... 4000	0 ... 9999
	Extra Long Range (XLR)	
	0 ... 4000	0 ... 9999
Electrical data		
Operating voltage U _B ³⁾	12 ... 24VDC ± 10%	
Residual ripple	≤ 10% of U _B	
Open-circuit current	≤ 40mA @ 24VDC	
Switching output	.../4... .../2...	pin 4/black: PNP pin 4/black: NPN
Function		light/dark switching, adjustable by means of a switch
Switching output time functions		switch-on/-off delay, passing contact (on actuation or fall-back), (combinations are limited → <i>Combinations of timing functions</i>)
Adjustable times (time functions)		0 ... 9999ms
Signal voltage high/low		≥ (U _B -2.5V) ≤ 2.5V
Output current		≤ 100mA
Sensitivity		adjustable using the teach function or +/- buttons
Indicators		
Yellow LED		switching output active
Display		2 x 7-segment LED, 4-digit, red: signal strength, green: switching threshold
Mechanical data		
Housing		ABS/PC black/red, transparent PC cover
Weight		50g with M8 connector 63g with 2000mm cable 70g with 150mm cable and M12 connector
Connection type		M8 connector, 4-pin, or 2000mm cable, 4 x 0.25mm ² , or 150mm cable with M12 connector, 4-pin clamp-mounting, 2 x Ø 2.2mm
Fiber optic connection		
Environmental data		
Ambient temp. (operation/storage)		-10°C ... +55°C/-20°C ... +85°C
Protective circuit ⁴⁾		2, 3
Protection class		IP 50, NEMA 1
Standards applied		EN 60947-5-2
Certifications		UL 508, C22.2 No.14-13 ⁵⁾
Options		
Sensor adjustment		menu-driven by means of display and rocker push button

- 1) Range/scanning range depending on the fiber optics used
- 2) With a duty cycle of 1:1
- 3) For UL applications: for use in class 2 circuits according to NEC only
- 4) 2=polarity reversal protection, 3=short circuit protection for all outputs
- 5) These proximity switches shall be used with UL Listed Cable assemblies rated 30V, 0.24A min, in the field installation, or equivalent (categories: CYJV/CYJV7 or PVVA/PVVA7)

Order guide

	Designation	Part no.
PNP types		
Connection: M8 connector, 4-pin	LV463B.7/4T-M8	50126588
Connection: cable 2000mm, 4 x 0.25mm ²	LV463B.7/4T	50126587
Connection: cable 150mm with M12 connector, 4-pin	LV463B.7/4T-150-M12	50126589
NPN types		
Connection: M8 connector, 4-pin	LV463B.7/2T-M8	50126591
Connection: cable 2000mm, 4 x 0.25mm ²	LV463B.7/2T	50126590
Connection: cable 150mm with M12 connector, 4-pin	LV463B.7/2T-150-M12	50126592

Remarks

NOTICE

Detailed specifications on the range/scanning range are enclosed in the data sheets of our fiber optics type **KF**, **KFX** or **GF**.

Explanation of the signal areas

Extra High Speed (XHS):
shortest response time; shortest operating range; display format 0 ... 4000

High Speed (HS):
very short response time; short operating range; display format 0 ... 4000

Speed (S):
short response time and operating range suitable for many standard applications; display format 0 ... 4000

Long Range (LR):
good response time; long operating range; display format 0 ... 9999

Extra Long Range (XLR):
longest response time; longest operating range; display format 0 ... 9999

Operate in accordance with intended use!

- ⚠ This product is not a safety sensor and is not intended as personnel protection.
- ⚠ The product may only be put into operation by competent persons.
- ⚠ Only use the product in accordance with the intended use.

Mounting the amplifier

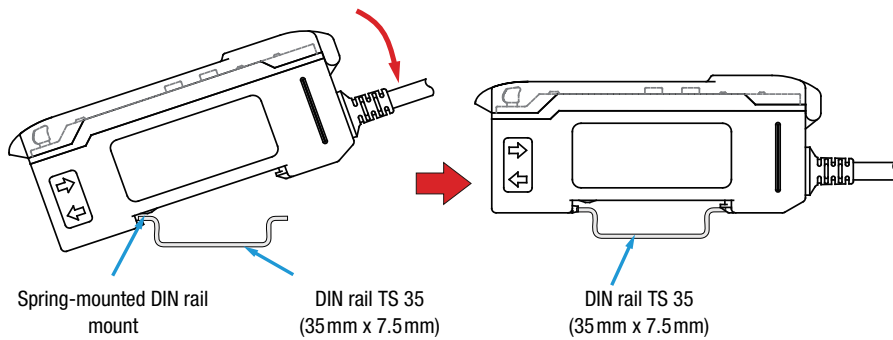

Alternatively, the amplifier can also be mounted without a DIN rail using the mounting accessory and M3 screws.

The amplifier is mounted as shown on a TS 35 DIN rail while disconnected from voltage.



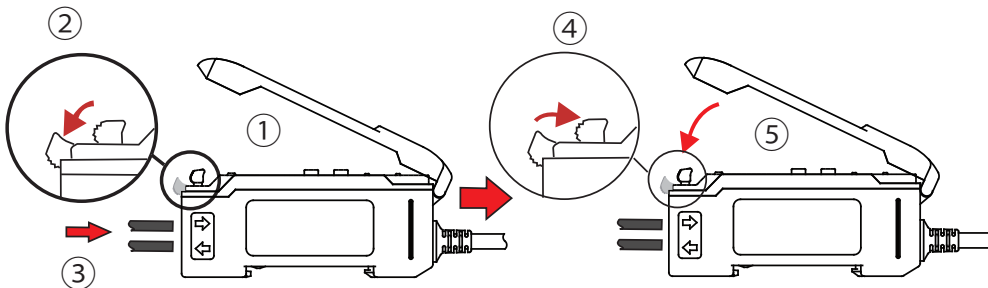



Installing the fiber optics

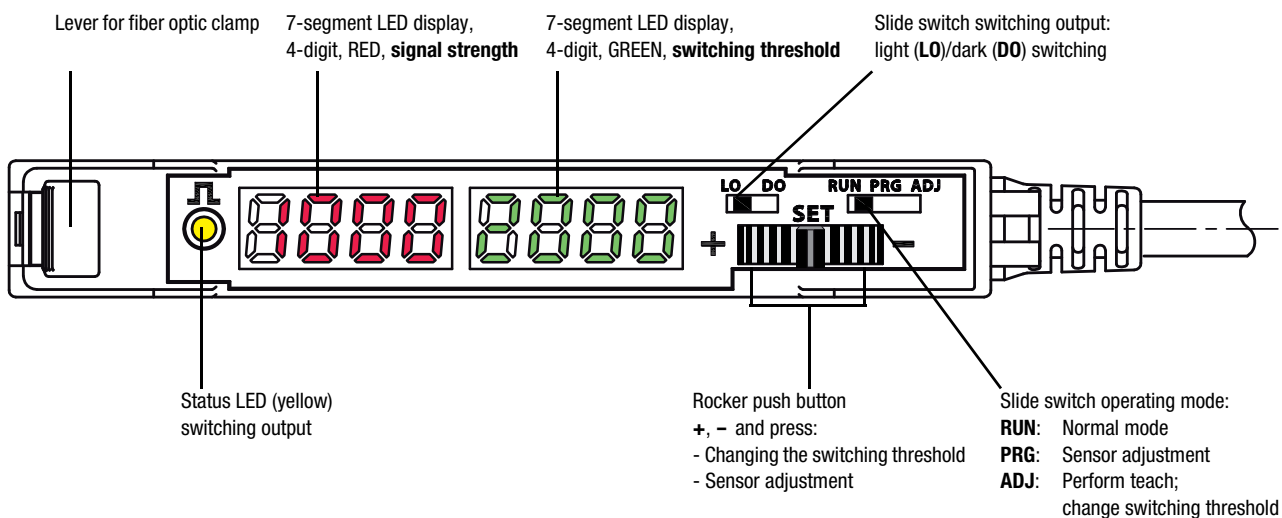

- ① Open the transparent protective cover.
- ② Push down the lever of the fiber optic clamp to open.
- ③ Lead the **KF/KFX/GF** type fiber optics in completely as far as they will go (ca. 12mm deep) into the fiber optic intake. **When doing so, observe the transmitter/receiver assignment** on the amplifier (transmitter at bottom / receiver on top).
- ④ Pull up the lever of the fiber optic clamp to close. Check if the clamp is secure by pulling lightly on the fiber optics.
- ⑤ Close the transparent protective cover.

Controls and indicators



	Selector switch Operating mode	RUN: Normal mode - no settings possible. ADJ: Press rocker push button: the set teach is executed. Rock to left - right: change the switching threshold, left = + and right = -. PRG: Menu-driven device setting via display and rocker push button.
	Selector switch Switching output	LO: Switching output light switching : If throughbeam fiber optics are installed, the switching output is active when the light path is free; if a scanning system is installed, the switching output is active when an object is detected. The status LED illuminates when the switching output is active. DO: Switching output dark switching : The switching behavior is the inversion of the light switching setting.
	Rocker push button - Set switching threshold - Navigation in menu	The rocker push button can be rocked to the right and to the left and pressed in the middle position. Rock +, -: In the ADJ operating mode, the switching threshold can be increased (+) or decreased (-) by rocking. In the PRG operating mode, rock to navigate in the menu. Button: Press the rocker push button in the middle position to accept a setting made in the PRG operating mode.
	Indicator Signal strength	In the RUN and ADJ operating modes, the display shows the current signal value. In the PRG operating mode, information on menu navigation appears on the display.
	Indicator Switching threshold	In the RUN and ADJ operating modes, the display shows the currently set switching threshold. In the PRG operating mode, information on menu navigation appears on the display.
	Status LED (yellow) Switching output state	LED ON Switching output active. LED OFF Switching output inactive.

RUN operating mode - normal operation

The RUN operating mode is the standard operating mode in which the sensor detects objects; it signals this according to the set functions. If the selector switch for the operating mode is in the **RUN** position, no changes can be made on the device. This setting is thus suitable for protection against unintended operation and changes to device settings.



PRG operating mode - sensor adjustment

The LV463 can be adjusted to meet customer requirements with a simple menu-driven system. To do this, set the **selector switch** for the **operating mode** to position **PRG**.



The menu consists of 13 successive subfunctions. Rock to right or left to freely navigate through the subfunctions.

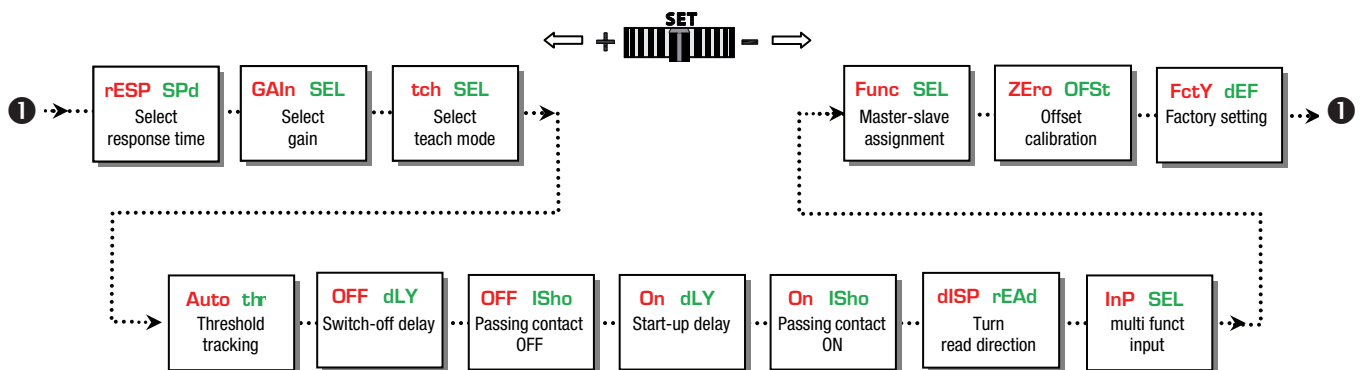

Selecting a subfunction and changing the setting

1. Rock to left or right to select the desired subfunction.
2. Press rocker push button in middle position. The currently set value is displayed statically.
3. Rock to right or left to display the selectable adjustment values - these flash slowly.
4. Accept the new value by pressing the rocker push button in the middle position.
Fast flashing indicates that the new value is accepted.
5. Automatic return to the heading for the subfunction.
6. Press again to statically display the previously selected value.

Description of the subfunctions

Subfunction	Possible settings / value range	Factory setting (default)	Explanation
rESP SPd Select response time	$t_{\text{RESP}} =$ 10 μs (signal range XHS) 15 μs (signal range HS) 50 μs (signal range S) 250 μs (signal range LR) 1000 μs (signal range XLR)	250 μs	The response time is the max. time required by the switching output to switch to the active state following a signal change at the input. From this, the switching frequency can be calculated as follows: $f = \frac{1}{2 \cdot t_{\text{RESP}}} \text{ [Hz]}$ Notice: A change to the response time is equivalent to a change to the signal range.
GAIIn SEL Select gain	Gain stage Gn 1 ... Gn 8; Auto GAIIn	Auto GAIIn	The gain stage can be set either by manually presetting a value between Gn 1 ... Gn 8 or automatically by selecting Auto GAIIn . The left, red display shows the current signal value. The gain stage should be selected so that the signal value is approximately in the middle of the display area. If Auto GAIIn is selected, the device automatically determines the optimum gain setting during teaching .
tch SEL Select teach mode	Teach modes 1 Pt tch (static), 2 Pt tch (static), dYn tch (dynamic)	1 Pt tch	Presetting a suitable teach process. To trigger the teach event, see Teaching operating mode . 1-point teach, static: during teaching, the current signal value is accepted as the new switching threshold. Actuate the rocker push button to make fine adjustments to the threshold. 2-point teach, static: the switching threshold is calculated at approximately midway between two signal values, e.g., teach to two different objects or teach to the same object at two different distances from the probe. Example: signal value 1 = 100 digits, signal value 2 = 400 digits → Switching threshold = 280 digits. Actuate the rocker push button to + or - to make fine adjustments to the threshold. Dynamic teach: suitable for processes that cannot be stopped for teaching. When the teach event is started, the sensor begins to scan the signal values. On the left, red display, the signal values are constantly displayed. At the end of the teach event, the switching threshold is calculated at approximately midway between the smallest and largest signal value.
Auto thr Threshold tracking	Tracking the switching threshold oFF, On	oFF	The function is only available during dynamic teaching. If the function is switched on, the switching threshold is automatically and continuously optimized by the sensor in such a way that maximum functional reliability is ensured. This can be used to compensate for, e.g., soiling or process changes. Warning message: thr ALrt: The limit of threshold tracking is reached - the sensor continues to operate. Cleaning and, if necessary, alignment of the fiber optics recommended. Error message: thr Err: The limit of threshold tracking is exceeded - the sensor stops operating . Cleaning and, if necessary, alignment of the fiber optics urgently necessary.
OFF dLY Switch-off delay	0 (off), 1 ... 9999 ms (milliseconds)	0	Switch-off delay (OFF Delay): Individually adjustable from 1 ... 9999 ms. Combination options → Combining timing functions
OFF ISho Passing contact OFF	0 (off), 1 ... 9999 ms (milliseconds)	0	Passing contact on fall-back (OFF 1-Shot): Individually adjustable from 1 ... 9999 ms. Combination options → Combining timing functions
On dLY Switch-on delay	0 (off), 1 ... 9999 ms (milliseconds)	0	Switch-on delay (ON Delay): Individually adjustable from 1 ... 9999 ms. Combination options → Combining timing functions
On ISho Passing contact ON	0 (off), 1 ... 9999 ms (milliseconds)	0	Passing contact on actuation (ON 1-Shot): Individually adjustable from 1 ... 9999 ms. Combination options → Combining timing functions

Subfunction	Possible settings / value range	Factory setting (default)	Explanation
dISP rEAd Turn read direction 180°	dISP rEAd, pV3J dSIP	dISP rEAd (same read direction as other texts)	Changes the read direction of the two 7-segment displays by 180°.
InP SEL multi funct input	oFF, tch InP, SYnc PLc, SYnc Int	oFF	Use this setting to define the function of the multi funct multifunction input (pin 2/ws-WH). oFF: Pin/cable has no function tch InP: Pin/cable can be used as teach input for line teach. For further information → Line teach / remote teach. SYnc PLc: Pin/ cable can be used as activation input. For further information → Synchronous operation of multiple amplifiers. SYnc Int: Setting for multiplex operation of up to six fiber optic amplifiers. For this purpose, all multi funct multifunction inputs (pin 2/ws-WH) are connected to one another. The master unit (defined with the next subfunction) generates a timing signal that is received by the slave units (defined with the next subfunction) via the parallel connection. In a fixed time frame, each slave successively activates its transmitter for a brief time and supplies a signal value. To avoid mutual interference, the transmitter is then again deactivated. For further information → Multiplex operation of multiple amplifiers.
Func SEL Master-slave assignment	SL 1, SL 2, SL 3, SL 4, SL 5, mA 2, mA 3, mA 4, mA 5, mA 6	SL 1	These settings must only be made if multiplex operation (master-slave operation) of multiple sensors is desired. Up to six sensors can be synchronized with one another in multiplex operation. In this case, exactly one master and 1 ... 5 slaves are always required. Master settings: mA n (number): Defines that this unit operates as master and a total of n sensors were wired in parallel. Value range n = 2 ... 6. Example: mA 4 means: Unit is the master , a total of four sensors are connected to one another via the multi funct multifunction input. Slave settings: SL n (number): Defines that this unit operates as a slave and has the individual address n . Value range for address n = 1 ... 5. Example: SL 3 means: Unit is a slave with the individual address 3. For further information → Multiplex operation of multiple amplifiers.
ZErO OFSt Offset calibration	no, YES	no	This subfunction is used for suppressing an offset signal that can result, e.g., from crosstalk between transmitter and receiver at the fiber optic head. To activate this function, select YES and confirm the selection by pressing the rocker push button. The current signal value is now set to 0 . To perform another offset calibration, the previous calibration must first be reset. To do this, select no and confirm by pressing the rocker push button. Now again perform the offset calibration as previously described. Notice: Resolution is lost when using offset suppression! Example: display area = 4000 digits, offset value = 550 digits → Remaining resolution = 3450 digits.
FctY dEF Factory setting	no, YES	no	Attention! Resets all sensor settings to factory settings. If desired, select YES and execute by pressing the rocker push button.



Tip!

- The maximum operating range can be achieved as follows:
- Set **rESP SPd** to **1000µs** (signal range **XLR**).
 - Set **GAIn SEL** to **Gn 8** (gain stage 8).
 - The switching threshold can be set to minimum 32 digits, the amplifier detects objects up to display value **0**.

Time functions

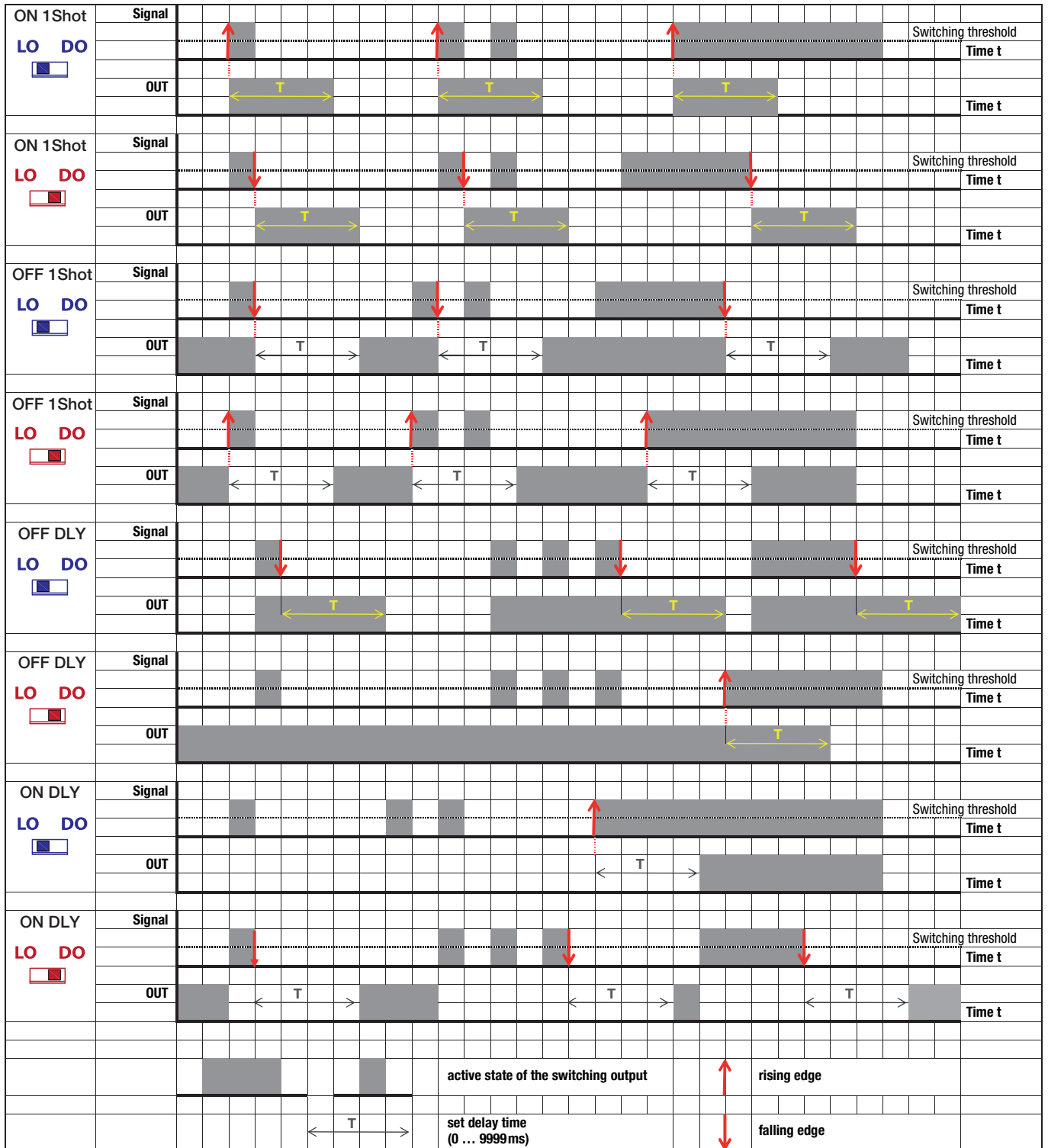

Combining timing functions

Timing functions can only be combined to a limited extent. Impermissible combinations are suppressed from the subfunctions menu. Here is an overview of the permissible combinations (•):

	OFF dLY Switch-off delay	OFF ISho Passing contact OFF	On dLY Switch-on delay	On ISho Passing contact ON
OFF dLY Switch-off delay		•	•	
OFF ISho Passing contact OFF	•			
On dLY Switch-on delay	•			•
On ISho Passing contact ON			•	

Teaching operating mode

Set the selector switch for the operating mode to the **ADJ** position.



Depending on the setting of the **Select teach mode** subfunction (**tch SEL**), one of the following teach modes appears:

- **Static 1-point teach**
- **Static 2-point teach**
- **Dynamic teach**

Teach process

Step	Static 1-point teach	Static 2-point teach	Dynamic teach
①	Place object in light beam. The red display shows the signal value, the green display the current switching threshold.	Place object in light beam. The red display shows the signal value, the green display the current switching threshold.	Press the rocker push button. The green display shows dYn , the red display the current signal value. The amplifier now scans signal values for approx. 1 minute.
②	Press the rocker push button; the teach value is accepted.	Press the rocker push button, first teach value is accepted.	Move several objects through the light beam; to end the event, press the rocker push button again. After the scanning time elapses, the teach event ends automatically.
③	Following a successful teach, PASS appears on the green display and the signal value is displayed as the new switching threshold. In the event of a faulty teach, FAIL appears on the red display. In this case, the signal value may be too small and cannot be accepted as a teach value (→ Table with minimum teach values as a function of the setting). Check object and/or placement and repeat event.	2nd appears on the green display; the red display shows the current signal value. Place object 2 or object at distance 2 and press the rocker push button within one minute . The second teach value is accepted. If the rocker push button is not pressed within one minute, the teach event is interrupted and the previous switching threshold is retained. Following a successful teach, PASS appears on the green display. The new switching threshold now lies approximately midway between the two taught signal values. In the event of a faulty teach, FAIL appears on the red display. In this case, the minimum distance between the two teach points may be too small (→ Table with minimum teach values as a function of the setting). Try to set a larger distance between the two signal values and repeat the event.	Following a successful teach, PASS appears on the green display. The new switching threshold now lies between the maximum and the minimum of the scanned signal values. In the event of a faulty teach, FAIL appears on the red display. In this case, the minimum distance between the scanned signal values may be too small (→ Table with minimum teach values as a function of the setting). Try to set a larger distance between the signal values and repeat the event.
④	The switching threshold can be freely increased or decreased at a later time by rocking the rocker push button to the left (+) and right (-). The change is accepted if both displays flash briefly several times.	The switching threshold can be freely increased or decreased at a later time by rocking the rocker push button to the left (+) and right (-). The change is accepted if both displays flash briefly several times.	The switching threshold can be freely increased or decreased at a later time by rocking the rocker push button to the left (+) and right (-). The change is accepted if both displays flash briefly several times.

Tip!
For reliable function, the difference between the signal value while an object is present and the signal value with no object should be at least 10 - 20%. In general: the larger the difference, the more reliable the detection.

Multiplex operation of multiple amplifiers

If multiple light axes are arranged close to each other, mutual interference – made evident by a widely varying display – may occur. To avoid this undesirable behavior, **up to six devices can be operated in multiplex operation**. To do this, it is only necessary to connect the **multi funct** multifunction inputs (pin 2/ws-WH) of all participating amplifiers – in addition to connecting the voltage supply and the switching signal.



All **multi funct** multifunction inputs (pin 2/ws-WH) are connected in parallel

● For settings, see subfunctions:

InP SEL multi funct input	Func SEL Master-slave assignment
--	---

- Maximum 6 / minimum 2 units: 1 x master + 1 ... 5 slaves.
- Each unit can be either a master or a slave.
- The master also requires information about the number of units wired in parallel (number of slaves).
- Each slave is also assigned an individual address 1 ... 5.
- The master generates a timing signal on pin 2 or on cable ws/WH.
- Each slave switches on its transmitter for 1 ms depending on its address.
- In multiplex mode, the cycle time is based on the total number of units:
Cycle time = number of units • 1.5ms + 0.5ms.

Synchronous operation of multiple amplifiers / operation with activation input

In some cases, one may also wish to query multiple light axes **simultaneously** (synchronously). Two options are available for this purpose:

Variant 1:

Wire and set according to section **Multiplex operation of multiple amplifiers** but assign all slaves an **identical address between 1 and 5**. Result: master and slaves have a time offset of 1.5ms, slaves with the same address operate synchronously.

Variant 2:

Synchronous operation by means of an external activation signal at **multi funct** input (pin 2/ws-WH). Setting for subfunction:

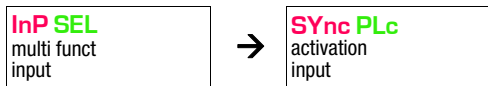

Function:

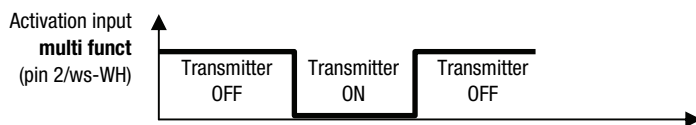

The transmitter is deactivated **with a high signal**. **If not actuated or in the case of a low signal, the transmitter is activated.**

Line teach (remote teach)

Setting for subfunction:

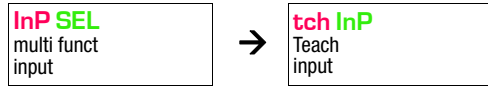

Signal level on **multi funct** teach input:

- The following description applies to PNP switching logic!
- I With the NPN models, the signal levels are inverted!

U_{Teach}	Signal level	Function
$\leq 2V$	LOW	The operating mode selector switch is unlocked - function acc. to current switch position.
$\geq (U_B - 2V)$	HIGH	The operating mode selector switch is locked - switch position has no effect on the sensor.

Timing for line teach

The line teach that is executed is determined in the **Select teach mode** subfunction **tch SEL**. Depending on the setting, this may be a static 1-point teach, static 2-point teach or dynamic teach.

