

**HRTL 96B**

**Laser light scanner with background suppression**

en 04-2014/07 50109888-01



**50 ... 6,500mm**



- Laser class 2
- Laser scanner with large detection range for universal application (visible red light)
- Light propagation time measurement makes use possible under extreme environmental conditions (brightness, light, interfering contours)
- Extremely simple operation, teachable switching points
- Time lock prevents unintentional changing of the switching points
- Automatic reserve and hysteresis ensure reliable switching behavior
- Switching behavior independent of the direction of movement
- Optimized for positioning tasks and reliable object detection (e.g. compartment occupancy monitoring, shelf positioning)
- Diagnostic function
- Deactivation input



**Accessories:**

(available separately)

- Mounting systems (BT 96, BT 96.1, UMS 96, BT 450.1-96)
- M12 connectors (KD ...)
- Ready-made cables (K-D ...)

**Dimensioned drawing**

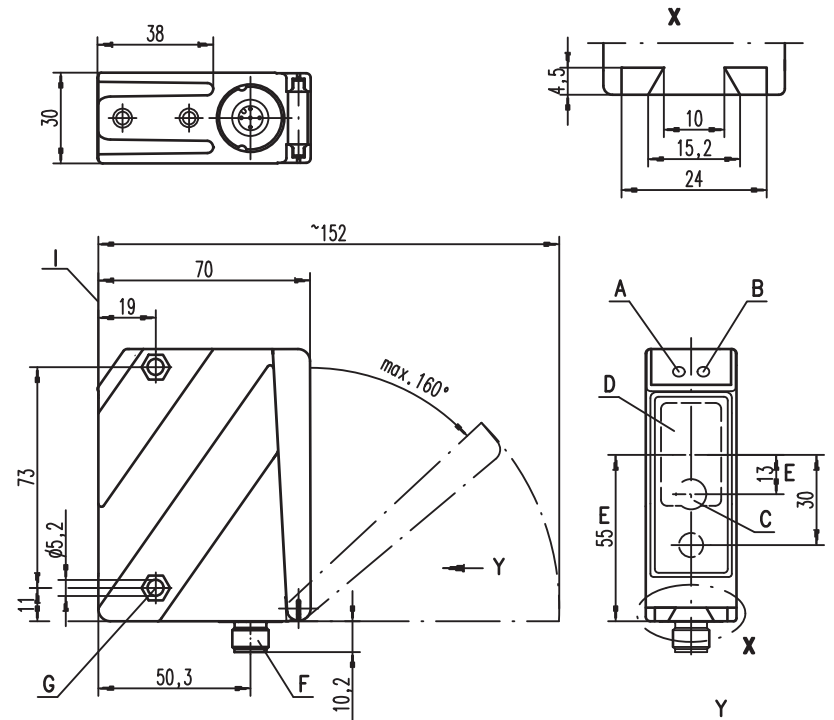

- A** Green indicator diode
- B** Yellow indicator diode
- C** Transmitter
- D** Receiver
- E** Optical axis
- F** Device plug M12x1
- G** Countersinking for SK nut M5, 4.2 deep
- H** Key pad
- I** Reference edge for the measurement (cover glass)
- K** Scanning range adjustment Q1/Q2/Q3
- L** Yellow indicator diodes for switching outputs Q1/Q2

**Electrical connection**

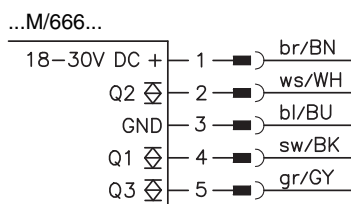
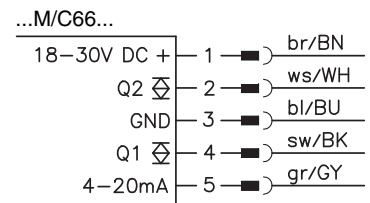
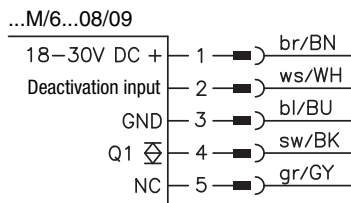
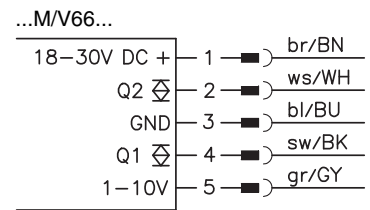
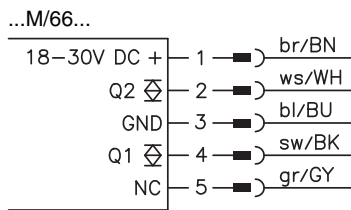

We reserve the right to make changes •

## Specifications

### Optical data

Typ. scanning range limit (white 90%) <sup>1)</sup>	50 ... 6500mm
Scanning range <sup>2)</sup>	100 ... 6000mm
Adjustment range / teach-in range	150 ... 6000mm / 6 ... 90% diffuse reflection
Light source	laser (red light)
Light spot diameter	1m:6mm / 3m:5mm / 5m:4mm / 7m:4mm
Wavelength	658nm

### Timing

Switching frequency	100Hz
Response time	5ms
Delay before start-up	≤ 200ms

### Electrical data

Operating voltage $U_B$ <sup>3)</sup>	18 ... 30VDC (incl. residual ripple)
Residual ripple	≤ 15% of $U_B$
Open-circuit current	≤ 120mA
Switching output <sup>4)</sup>	.../6... 1 push-pull switching output
	.../66... 2 push-pull switching outputs
	.../666... 3 push-pull switching outputs
	see order guide
Switching behavior	
Signal voltage high/low	≥ ( $U_B - 2V$ ) / ≤ 2V
Output current	max. 100mA for Q1/Q2, max. 20mA for Q3
Analog output <sup>5)</sup>	.../V66... 1 ... 10V
	.../C66... 4 ... 20mA

### Indicators

<b>Sensor front</b>	
Green LED	ready
Yellow LED	reflection (Q <sub>1</sub> )
<b>Sensor back</b>	see table

### Mechanical data

Housing	<b>Metal housing</b>
Optics cover	diecast zinc
Weight	glass
Connection type	380g
	M12 connector, 5-pin

### Environmental data

Ambient temp. (operation/storage)	-40°C ... +50°C / -35°C ... +70°C
Protective circuit <sup>6)</sup>	1, 2, 3, 4
VDE safety class <sup>7)</sup>	II, all-insulated
Degree of protection	IP 67, IP 69K <sup>8)</sup>
Laser class	2 in accordance with DIN EN 60825-1:2008-05
Standards applied	IEC 60947-5-2
Certifications	UL 508, C22.2 No.14-13 <sup>3) 9) 10)</sup>

### Options

#### Deactivation input

Transmitter inactive/active	≥ 8V/≤ 2V <sup>11)</sup>
Activation/disable delay	≥ 20ms
Input resistance	10KΩ ± 10%

- 1) Typ. scanning range limit: max. attainable range without performance reserve
- 2) Scanning range: recommended range with performance reserve
- 3) For UL applications: for use in class 2 circuits according to NEC only
- 4) The push-pull switching outputs must not be connected in parallel
- 5) Configurable at the factory, measurement ranges of 100 ... 15000mm possible
- 6) 1=transient protection, 2=polarity reversal protection, 3=short circuit protection for all outputs, 4=interference blanking
- 7) Rating voltage 250VAC
- 8) IP 69K test in accordance with DIN 40050 part 9 simulated, high pressure cleaning conditions without the use of additives, acids and bases are not part of the test
- 9) These proximity switches shall be used with UL Listed Cable assemblies rated 30V, 0.5A min, in the field installation, or equivalent (categories: CYJV/CYJV7 or PVVA/PVVA7)
- 10) CAUTION - Use of controls or adjustments or performance of procedures other than those specified herein may result in hazardous radiation exposure.
- 11) Upon deactivation of the laser, output Q1 becomes inactive.
- 12) Inverted for dark switching

## Tables

Switching points	no reflection	object detected
Yellow LED Q 1	off	on
Yellow LED Q 2	off	on

## Diagrams

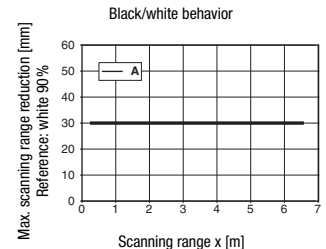

A 6 ... 90% diffuse reflection

## Remarks

- Setting switching points Q1/Q2: Align sensor with object, press respective teach button for at least 2s, then release the button. Object is detected if the corresponding Q1/Q2 indicator illuminates.<sup>12)</sup>
- Setting switching point Q3: Press teach button 1 for approx. 12s, release after LED flashes rapidly, switching point is taught. No LED provided for Q3.
- Reserve: For the reliable detection of objects with low reflectance, a reserve is automatically added during the teach event. This is constant over the entire teach range.  
Object is detected: distance to sensor ≤ teach point + reserve
- Hysteresis: To ensure continuous object detection in the switching point, the sensor has a switch-off hysteresis.  
Object is no longer detected if: distance to sensor > teach-in point + reserve + hysteresis.
- Factory setting:  
reserve: approx. 50mm  
hysteresis: approx. 50mm
- Object detection:  
resolution < 5mm, standard deviation ±10mm at ±3 Sigma
- Edge detection/shelf positioning:  
repeatability < 1mm
- With the set scanning range, a tolerance of the upper scanning range limit is possible depending on the reflection properties of the material surface.
- Scanning range/reflectivity:

Object/diffuse reflection	
6 ... 90%	0.15 ... 6m (standard)

### Operate in accordance with intended use.

- ⚠ This product is not a safety sensor and is not intended as personnel protection.
- ⚠ The product may only be put into operation by competent persons.
- ⚠ Only use the product in accordance with the intended use.

## HRTL 96B

## Laser light scanner with background suppression

### Order guide

Selection table		Order code														
Equipment ↓		HRTL 96BM/66.01S-S12 Part no. 50108889	HRTL 96BM/V66.02S-S12 Part no. 50110728	HRTL 96BM/V66.01S-S12 Part no. 50110952	HRTL 96BM/6.09S-S12 Part no. 50110990	HRTL 96BM/6.09.01S-S12 Part no. 50111122	HRTL 96B M/C66.01S-S12 Part no. 50111208	HRTL 96B M/V66.03S-S12 Part no. 50111486	HRTL 96B M/6.9.02S-S12 Part no. 50111846	HRTL 96B M/666.01S-S12 Part no. 50112804	HRTL 96B M/C66.02S-S12 Part no. 50113595	HRTL 96B M/66.02S-S12 Part no. 50113800	HRTL 96B M/C66.03S-S12 Part no. 50114306	HRTL 96B M/66.07S-S12 Part no. 50121404	HRTL 96B M/C66.05S-S12 Part no. 50122124	
Housing	metal	●	●	●	●	●	●	●	●	●	●	●	●	●	●	
Light source	red light laser	●	●	●	●	●	●	●	●	●	●	●	●	●	●	
Connection	M12 connector, 5-pin	●	●	●	●	●	●	●	●	●	●	●	●	●	●	
Outputs	2 switching points	●	●	●			●									
	1 x push-pull, PNP light switching/NPN dark switching				●				●							
	1 x push-pull, PNP light switching/NPN dark switching, small hysteresis (20 mm)					●										
	2 x push-pull, PNP light switching/NPN dark switching	●	●	●			●	●					●		●	
	2 x push-pull, PNP dark switching/NPN light switching										●	●				
	2 x push-pull, Q1: PNP dark switching/NPN light switching, Q2: PNP light switching/NPN dark switching													●		
	3 x push-pull, PNP light switching/NPN dark switching									●						
	teachable switching points	●	●	●	●	●	●	●	●	●	●	●	●	●	●	●
	analog / voltage (range = 100 ... 1500 mm)		●													
	analog / voltage (range = 100 ... 6000 mm)			●												
	analog / voltage (range = 100 ... 15000 mm)							●								
	analog / current (range = 150 ... 2000 mm)												●			
	analog / current (range = 100 ... 3000 mm)															●
	analog / current (range = 100 ... 6000 mm)						●									
analog / current (range = 100 ... 15000 mm)										●						
Input	deactivation				●	●			●							
Parameterization	application-specific							●								

**Laser safety notices**

**⚠ ATTENTION, LASER RADIATION – LASER CLASS 2**

**Never look directly into the beam!**

The device fulfills the EN 60825-1:2008-05 (IEC 60825-1:2007) safety regulations for a product in **laser class 2** as well as the U.S. 21 CFR 1040.10 regulations with deviations corresponding to "Laser Notice No. 50" from June 24th, 2007.

- ↳ Never look directly into the laser beam or in the direction of reflecting laser beams!  
If you look into the beam path over a longer time period, there is a risk of injury to the retina.
- ↳ Do not point the laser beam of the device at persons!
- ↳ Intercept the laser beam with an opaque, non-reflective object if the laser beam is accidentally directed towards a person.
- ↳ When mounting and aligning the device, avoid reflections of the laser beam off reflective surfaces!
- ↳ **CAUTION!** Use of controls or adjustments or performance of procedures other than specified herein may result in hazardous light exposure.  
The use of optical instruments or devices (e.g., magnifying glasses, binoculars) with the product will increase eye hazard.
- ↳ Adhere to the applicable legal and local regulations regarding protection from laser beams acc. to EN 60825 (IEC 60825) in its latest version.
- ↳ The device must not be tampered with and must not be changed in any way.  
There are no user-serviceable parts inside the device.  
Repairs must only be performed by Leuze electronic GmbH + Co. KG.

**NOTICE**

**Affix laser information and warning signs!**

Laser information and warning signs are affixed to the device (see ①). In addition, self-adhesive laser information and warning signs (stick-on labels) are supplied in several languages (see ②).

- ↳ Affix the laser information sheet with the language appropriate for the place of use to the device.  
When using the device in the US, use the stick-on label with the "Complies with 21 CFR 1040.10" notice.
- ↳ Affix the laser information and warning signs near the device if no signs are attached to the device (e.g. because the device is too small) or if the attached laser information and warning signs are concealed due to the installation position.  
Affix the laser information and warning signs so that they are legible without exposing the reader to the laser radiation of the device or other optical radiation.

①



**A** Laser exit opening  
**B** Laser warning sign

②

**50108905-03**

<p style="text-align: center; font-size: small;">LASERSTRAHLUNG NICHT IN DEN STRAHL BLICKEN</p> <p style="font-size: x-small;">Max. Leistung (peak): 248 mW Impulsdauer: 6.5 ns Wellenlänge: 658 nm</p> <p style="text-align: center; font-size: x-small;">LASER KLASSE 2 DIN EN 60825-1:2008-05</p>	<p style="text-align: center; font-size: small;">RADIACIONE LASER NON FISSARE IL FASCIO</p> <p style="font-size: x-small;">Potenza max. (peak): 248 mW Durata dell'impulso: 6.5 ns Lunghezza d'onda: 658 nm</p> <p style="text-align: center; font-size: x-small;">APPARECCHIO LASER DI CLASSE 2 EN 60825-1:2007</p>
<p style="text-align: center; font-size: small;">LASER RADIATION DO NOT STARE INTO BEAM</p> <p style="font-size: x-small;">Maximum Output (peak): 248 mW Pulse duration: 6.5 ns Wavelength: 658 nm</p> <p style="text-align: center; font-size: x-small;">CLASS 2 LASER PRODUCT EN 60825-1:2007</p>	<p style="text-align: center; font-size: small;">RAYONNEMENT LASER NE PAS REGARDER DANS LE FASCIEAU</p> <p style="font-size: x-small;">Puissance max. (crête): 248 mW Durée d'impulsion: 6.5 ns Longueur d'onde: 658 nm</p> <p style="text-align: center; font-size: x-small;">APPAREIL À LASER DE CLASSE 2 EN 60825-1:2007</p>
<p style="font-size: x-small;">AVOID EXPOSURE – LASER RADIATION IS EMITTED FROM THIS APERTURE</p>	<p style="font-size: x-small;">EXPOSITION DANGEREUSE – UN RAYONNEMENT LASER EST EMIS PAR CETTE OUVERTURE</p>
<p style="text-align: center; font-size: small;">RADIACION LASER NO MIRAR FIJAMENTE AL HAZ</p> <p style="font-size: x-small;">Potencia max. (peak): 248 mW Duración del impulso: 6.5 ns Longitud de onda: 658 nm</p> <p style="text-align: center; font-size: x-small;">PRODUCTO LASER DE CLASE 2 EN 60825-1:2007</p>	<p style="text-align: center; font-size: small;">RADIACÃO LASER NÃO OLHAR FIXAMENTE O FEIXE</p> <p style="font-size: x-small;">Potência max. (peak): 248 mW Período de pulso: 6.5 ns Comprimento de onda: 658 nm</p> <p style="text-align: center; font-size: x-small;">EQUIPAMENTO LASER CLASSE 2 EN 60825-1:2007</p>
<p style="text-align: center; font-size: small;">LASER RADIATION DO NOT STARE INTO BEAM</p> <p style="font-size: x-small;">Maximum Output (peak): 248 mW Pulse duration: 6.5 ns Wavelength: 658 nm</p> <p style="text-align: center; font-size: x-small;">CLASS 2 LASER PRODUCT EN 60825-1:2007 Complies with 21 CFR 1040.10</p>	<p style="text-align: center; font-size: small;">激光辐射 勿直视光束</p> <p style="font-size: x-small;">最大输出 (峰值): 248 mW 脉冲持续时间: 6.5 ns 波长: 658 nm</p> <p style="text-align: center; font-size: x-small;">2 类激光产品 GB7247.1-2012</p>

