



PRK 96

Retro-reflective photoelectric sensors with polarisation filter



Dimensioned drawing

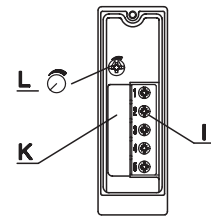
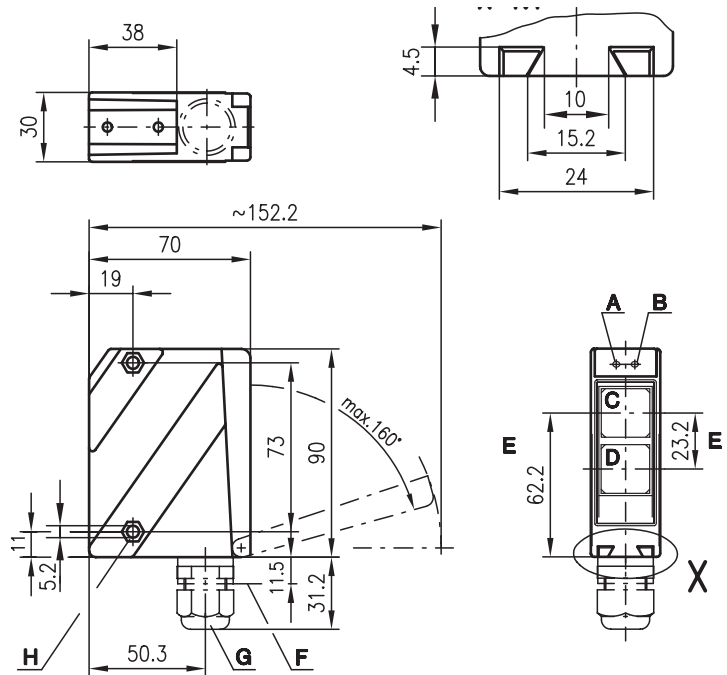

- A Indicator diode green
- B Indicator diode yellow
- C Receiver
- D Transmitter
- E Optical axis
- F Device plug M12x1
- G Screwed cable gland M16x1.5 for Ø 5 ... 10mm
- H Countersinking for SK nut M5, 4.2 deep
- I Connection terminals
- K Cable entry
- L Sensitivity adjustment



10m

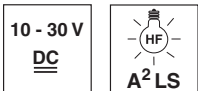

- Polarised retro-reflective photoelectric sensor with large operating range in visible red light
- Robust metal housing with glass cover or plastic housing, protection class IP 67/ IP 69K for industrial application
- Sensitivity adjustment and delay before start-up for optimal adaptation to the application
- Connection via M12 connector or terminal compartment
- Activation input for e.g. muting applications

Electrical connection

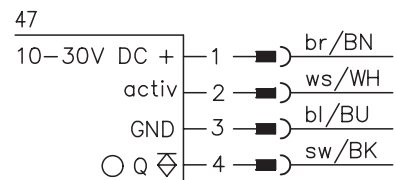
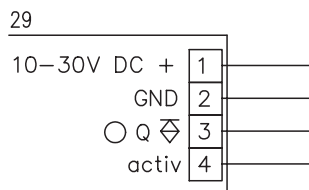

Accessories:

(available separately)

- Mounting systems (BT 96, BT 96.1, UMS 96, BT 450.1-96)
- M12 connectors (KD ...)
- Ready-made cables (K-D ...)
- Reflectors
- Reflective tapes

We reserve the right to make changes • 96_b04e.fm

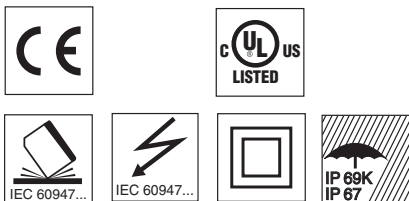

Specifications

Optical data

Typ. operating range limit (TK(S) 100x100) ¹⁾	10 m
Operating range ²⁾	see tables
Light spot diameter	approx. 130mm at 6m
Light source	LED (modulated light)
Wavelength	660nm (visible red light, polarised)

Timing

Switching frequency	1000Hz
Response time	0.5ms
Delay before start-up	≤ 200ms

Electrical data

Operating voltage U_B	10 ... 30VDC (incl. residual ripple)
Residual ripple	≤ 15% of U_B
Bias current	≤ 40mA
Switching output	PNP transistor
Function characteristics	light switching
Signal voltage high/low	≥ ($U_B - 2V$) / ≤ 2V
Output current	max. 100mA
Sensitivity	adjustable

Indicators

LED green	ready
LED yellow	light path free
LED yellow flashing	light path free, no performance reserve

Mechanical data

Housing	diecast zinc	Plastic housing	polycarbonate
Optics cover	glass		plastic
Weight	380g		150g
Connection type	terminals or M12 connector		

Environmental data

Ambient temp. (operation/storage)	-20°C ... +55°C / -40°C ... +55°C
Protective circuit ³⁾	1, 2, 3, 4
VDE safety class ⁴⁾	II, all-insulated
Protection class	IP 67, IP 69K ⁵⁾
LED class	1 (acc. to EN 60825-1)
Standards applied	IEC 60947-5-2

Options

Activation input activ	
Transmitter active/not active	≥ 8V / ≤ 2V (≥ 2V / ≤ 2V) ⁶⁾
Activation/disable delay	≤ 0.5ms
Input resistance	47KΩ ± 10%

- 1) Typ. operating range limit: max. attainable range without performance reserve
- 2) Operating range: recommended range with performance reserve
- 3) 1=transient protection, 2=polarity reversal protection, 3=short circuit protection for all outputs, 4=interference blanking
- 4) Rating voltage 250VAC
- 5) IP 69K test acc. to DIN 40050 part 9 simulated, high pressure cleaning conditions without the use of additives, acids and bases are not part of the test
- 6) Active low

Order guide

Selection table		Order code →			
Equipment ↓		PRK 96K/P-1361-29 Part No. 500 80476	PRK 96M/P-1361-47 Part No. 500 82092	PRK 96K/P-1363-29 Part No. 500 80656	PRK 96M/P-1362-47 Part No. 500 80477
Housing	metal		●		●
	plastic	●		●	
Light source	red light (8m)	●	●	●	●
Connection	terminals	●		●	
	M12 connector		●		●
Features	activation input	●	●	● ⁶⁾	●
	optics heating/low temperature				●

Tables

Reflectors	Operating range
1 TK(S) 100x100	0.3 ... 8m
2 MTK(S) 50x50	0.3 ... 7m
3 TK(S) 30x50	0.3 ... 4.5m
4 TK(S) 20x40	0.3 ... 3m
5 TK(S) 82	0.3 ... 6m
6 Tape 2 100x100	0.3 ... 4m

1	0.1	8	10
2	0.1	7	8.5
3	0.1	4.5	5
4	0.1	3	4
5	0.1	6	7.5
6	0.1	4	5.5

- Operating range [m]
 Typ. operating range limit [m]

- TK ... = adhesive
 TKS ... = screw type
 Tape 2 = adhesive

Diagrams

Typ. response behaviour (TKS 100x100)

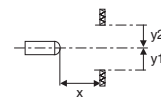
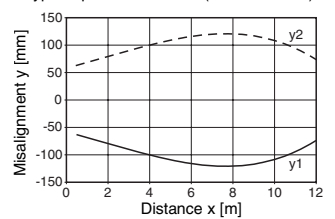

Remarks

- The polarised retro-reflective photoelectric sensor is also available with an integrated AS-i chip for direct connection to the AS-i system.
- **PRK 96K/P-1363-29**
Activation via active low signal