

HT46C

Diffuse reflection light scanners with background suppression

en 01-2015/06 50129624

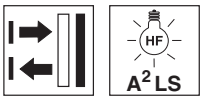

**5 ... 3000mm**  
1200mm with  
black-white error < 10%



- Scanner with adjustable background suppression in red light version
- Reliable detection of objects with different surface structures
- Large adjustment range and minimal zero distance for optimum adaptation to the application
- Highly visible status displays
- Exact switching point adjustment through mechanical adjusting spindle
- Activation input for sensor test
- Various switching output functions for universal connection to existing control environment
- A²LS active ambient light suppression for avoiding mutual interference
- Robust plastic housing in degrees of protection IP67 and IP69K

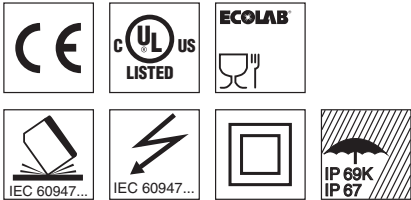

**Accessories:**

(available separately)

- Mounting systems (BT 46, BTU 300M, BT 300, BTU 346)
- M12 connectors (KD ...)
- Ready-made cables (K-D ...)

**Dimensioned drawing**

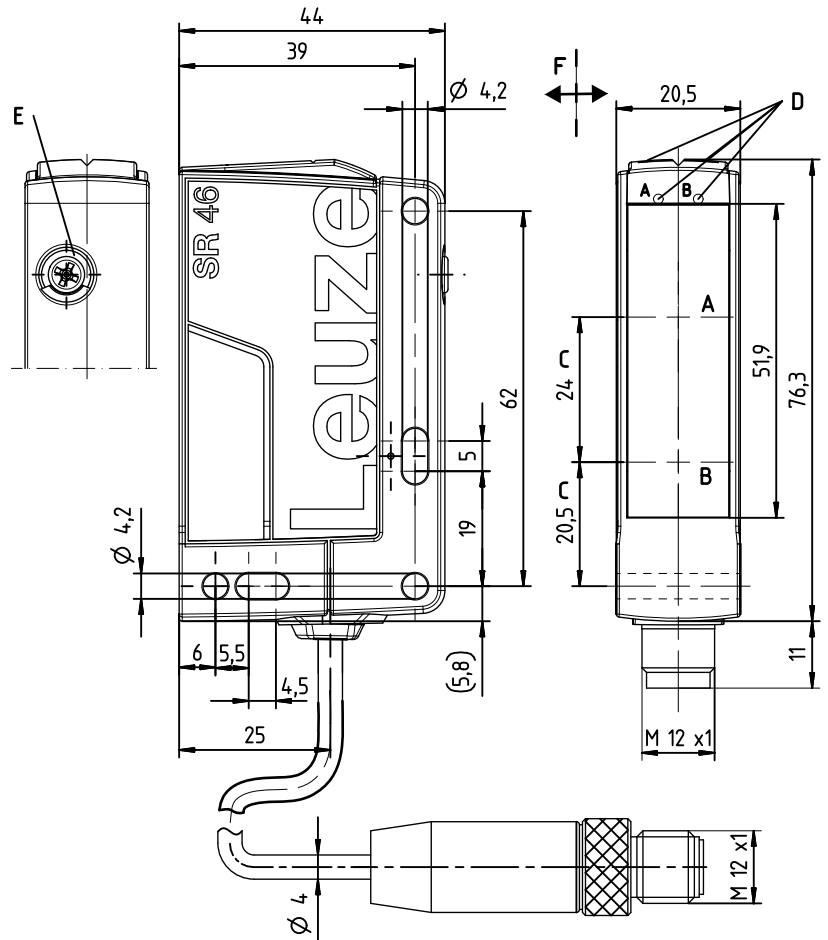

- A** Receiver
- B** Transmitter
- C** Optical axis
- D<sub>A</sub>** Green indicator diode
- D<sub>B</sub>** Yellow indicator diode
- E** Scanning range adjustment
- F** Preferred movement for objects

**Electrical connection**

Connector, 4-pin

U <sub>B</sub>	1	br/BN
OUT/IN <sup>*)</sup>	2	ws/WH
GND	3	bl/BU
OUT1	4	sw/BK

Cable

U <sub>B</sub>	1	br/BN
OUT/IN <sup>*)</sup>	2	ws/WH
GND	3	bl/BU
OUT1	4	sw/BK

Selection pin 2

*)	OUT	IN
	OUT 2	Active
	Warn	
	NC	

We reserve the right to make changes • DS\_HT46C\_en\_50129624.fm

## Specifications

### Optical data

Typ. scanning range limit (white 90%) <sup>1)</sup>	5 ... 3000mm
Scanning range <sup>2)</sup>	see diagrams
Black-white error	<10% up to 1200mm
Scanning range adjustment	mechanical adjusting spindle
Adjustment range	120 ... 3000mm
Light source	LED (modulated light)
Wavelength	630nm (visible red light)

### Timing

Switching frequency	250Hz
Response time	2ms
Delay before start-up	≤ 300ms

### Electrical data

Operating voltage $U_B$ <sup>3)</sup>	10 ... 30VDC (incl. residual ripple)												
Residual ripple	≤ 15% of $U_B$												
Open-circuit current	≤ 20mA												
Switching outputs/functions <sup>4)</sup>	<table border="0"> <tr> <td>/4P</td> <td>2 PNP switching outputs, antivalent</td> </tr> <tr> <td>/4X</td> <td>1 PNP switching output, light switching</td> </tr> <tr> <td>/4W</td> <td>1 PNP switching output, light switching, 1 PNP warning output</td> </tr> <tr> <td>/48</td> <td>1 PNP switching output, light switching, 1 activation input</td> </tr> <tr> <td>/PX</td> <td>1 PNP switching output, dark switching</td> </tr> <tr> <td>/2N</td> <td>2 NPN switching outputs, antivalent</td> </tr> </table>	/4P	2 PNP switching outputs, antivalent	/4X	1 PNP switching output, light switching	/4W	1 PNP switching output, light switching, 1 PNP warning output	/48	1 PNP switching output, light switching, 1 activation input	/PX	1 PNP switching output, dark switching	/2N	2 NPN switching outputs, antivalent
/4P	2 PNP switching outputs, antivalent												
/4X	1 PNP switching output, light switching												
/4W	1 PNP switching output, light switching, 1 PNP warning output												
/48	1 PNP switching output, light switching, 1 activation input												
/PX	1 PNP switching output, dark switching												
/2N	2 NPN switching outputs, antivalent												
Signal voltage high/low	≥ ( $U_B - 2V$ ) / ≤ 2V												
Output current	max. 100mA												

### Indicators

Green LED	ready
Yellow LED	reflection
Yellow LED, flashing	reflection, no performance reserve

### Mechanical data

Housing	plastic	
Optics cover	plastic	
Weight	with M12 connector: approx. 60g	
	with 200mm cable and M12 connector: approx. 65g	
	with 2000mm cable: approx. 100g	
Connection type	M12 connector, 4-pin cable 200mm with M12 connector, 4-pin cable 2000mm, 4 x 0.21 mm <sup>2</sup>	

### Environmental data

Ambient temp. (operation/storage)	-40°C ... +60°C / -40°C ... +70°C
Protective circuit <sup>5)</sup>	2, 3
VDE safety class <sup>6)</sup>	II, all-insulated
Protection class	IP 67, IP 69K
Light source	exempt group (in acc. with EN 62471)
Standards applied	IEC 60947-5-2
Certifications	UL 508, CSA C22.2 No.14-13 <sup>4) 7)</sup>

### Options

<b>Warning output</b>	PNP transistor, counting principle
Signal voltage high/low	≥ ( $U_B - 2V$ ) / ≤ 2V
Output current	max. 100mA
<b>Activation input</b>	
Transmitter active/not active	≥ 8V / ≤ 2V
Activation/disable delay	≤ 1ms / ≤ 2ms
Input resistance	10KΩ ± 10%

- 1) Typ. scan. range limit: max. achievable scanning range for light objects (white 90%)
- 2) Scanning range: recommended scanning range for objects with different diffuse reflection
- 3) For UL applications: for use in class 2 circuits only
- 4) See part number code
- 5) 2=polarity reversal protection, 3=short circuit protection for all transistor outputs
- 6) Rating voltage 50V
- 7) These proximity switches shall be used with UL Listed Cable assemblies rated 30V, 0.5A min, in the field installation, or equivalent (categories: CYJV/CYJV7 or PVVA/PVVA7)

## Tables

1	5	3000
2	20	2000
3	50	1500

1	white 90%
2	gray 18%
3	black 6%

Scanning range [mm]

## Diagrams

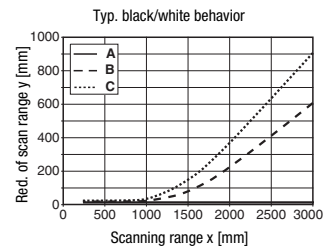
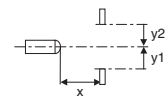
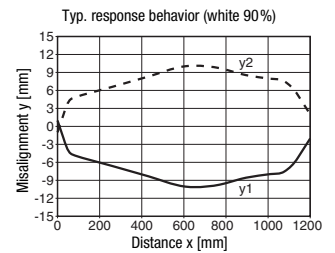

- A white 90%
- B gray 18%
- C black 6%

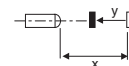

## Remarks

### Operate in accordance with intended use!

- ⚠ This product is not a safety sensor and is not intended as personnel protection.
- ⚠ The product may only be put into operation by competent persons.
- ⚠ Only use the product in accordance with the intended use.

# HT46C

# Diffuse reflection light scanners with background suppression

## Part number code

H	T	4	6	C			/	4	P	-	2	0	0	-	M	1	2
---	---	---	---	---	--	--	---	---	---	---	---	---	---	---	---	---	---

### Operating principle

**HT** Diffuse reflection light scanners with background suppression

### Series

**46C** 46C series

### Light type

**Free** Red light

**I** Infrared light

### Setting

**Free** Scanning range adjustment via mechanical adjusting spindle

### Pin assignment of OUT1 (connector pin 4 / black cable wire)

**2** NPN, light switching

**N** NPN, dark switching

**4** PNP, light switching

**P** PNP, dark switching

### Pin assignment of OUT/IN (connector pin 2 / white cable wire)

**X** Not assigned

**2** NPN, light switching

**N** NPN, dark switching

**4** PNP, light switching

**P** PNP, dark switching

**8** Activation input (active high)

**W** Warning output, PNP light switching

### Connection technology

**M12** M12 connector, 4-pin

**200-M12** Cable 200 mm with M12 connector, 4-pin

**Free** Cable 2000 mm

## Order guide

The sensors listed here are preferred types; current information at [www.leuze.com](http://www.leuze.com).

### Red-light diffuse reflection light scanner with background suppression

### Designation

### Part no.

#### With M12 connector, 4-pin

OUT1: PNP light switching; OUT2: PNP dark switching

HT46C/4P-M12

50127048

OUT1: PNP light switching; OUT2: no contact<sup>1)</sup>

HT46C/4X-M12

50127050

OUT1: PNP light switching; IN: activation input active high

HT46C/48-M12

50127054

OUT1: PNP light switching; OUT2: warning output PNP active high

HT46C/4W-M12

50127055

OUT1: PNP dark switching; OUT2: no contact<sup>1)</sup>

HT46C/PX-M12

50127051

OUT1: NPN light switching; OUT2: NPN dark switching

HT46C/2N-M12

50129670

#### Cable 0.2m with M 12 connector, 4-pin

OUT1: PNP light switching; OUT2: PNP dark switching

HT46C/4P-200-M12

50129752

OUT1: PNP dark switching; OUT2: no contact<sup>1)</sup>

HT46C/PX-200-M12

50127052

#### Cable 2m

OUT1: PNP light switching; OUT2: PNP dark switching

HT46C/4P

50127049

1) Direct connection to AS-i coupling modules possible