



HRT 96

Diffuse reflection light scanner with background suppression



Dimensioned drawing

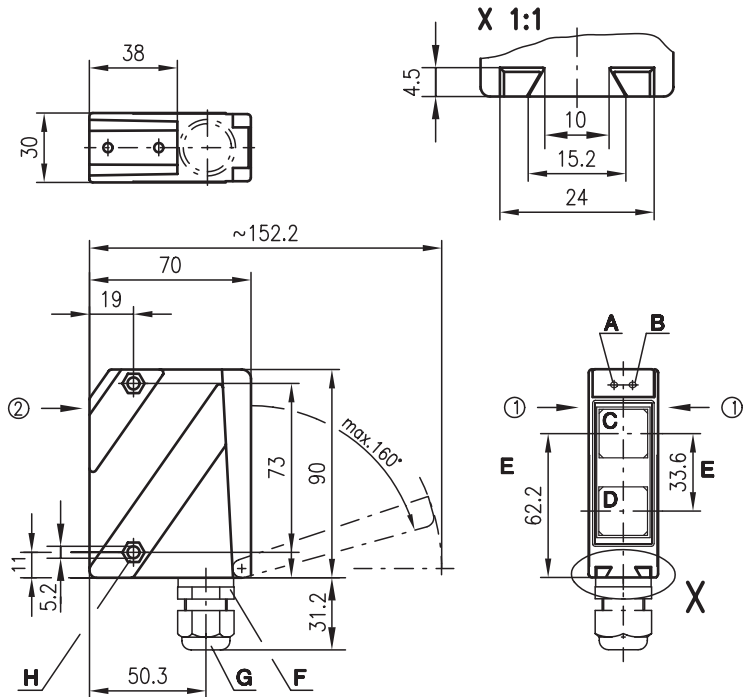

100 ... 1200mm

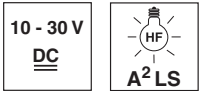

- Scanner with adjustable background suppression using visible red light
- Robust metal housing with glass cover or plastic housing, protection class IP 67 for industrial application
- Complementary outputs for standard applications and a wide range of input and output variants for optimum adaptation to the application
- Connection via M12 connector or terminal compartment
- Various options with switching delays, light/dark switching, activation input, and optics heating combined with low temperature

- A Indicator diode green
 - B Indicator diode yellow
 - C Transmitter
 - D Receiver
 - E Optical axis
 - F Device plug M12x1
 - G Screwed cable gland M16x1.5 for Ø 5 ... 10mm
 - H Countersinking for SK nut M5, 4.2 deep
 - I Connection terminals
 - K Cable entry
 - L Scanning range adjustment
- Preferred entry direction for objects ① + ②

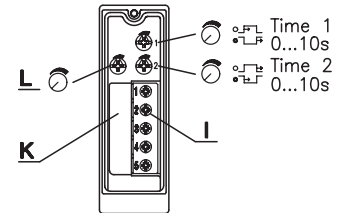

Electrical connection

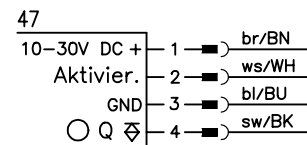
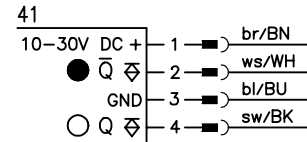
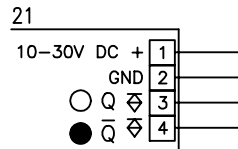

Accessories:

(available separately)

- Mounting systems (BT 96, BT 96.1, UMS 96, BT 450.1-96)
- M12 connectors (KD ...)
- Ready-made cables (K-D ...)

We reserve the right to make changes*96_d09e.fm

Specifications

Optical data

Typ. scanning range limit (white 90%) ¹⁾
 Scanning range ²⁾
 Adjustment range
 Light source
 Wavelength

Red light

100 ... 1200mm
 see tables
 100 ... 800mm
 LED (modulated light)
 660nm

Timing

Switching frequency 300Hz
 Response time 1.67ms
 Delay before start-up ≤ 200ms

Electrical data

Operating voltage U_B 10 ... 30VDC (incl. residual ripple)
 Residual ripple ≤ 15% of U_B
 Bias current ≤ 35mA
 Switching output PNP transistor
 Function characteristics light or dark switching
 Signal voltage high/low ≥ ($U_B - 2V$) / ≤ 2V
 Output current max. 100mA

Indicators

LED green ready
 LED yellow reflection

Mechanical data

Housing polycarbonate
 Optics cover plastic
 Weight 150g
 Connection type terminals or M12 connector

Environmental data

Ambient temp. (operation/storage) -20°C ... +60°C / -40°C ... +70°C
 Protective circuit ³⁾ 1, 2, 3, 4
 VDE safety class ⁴⁾ II, all-insulated
 Protection class IP 67
 LED class 1 (acc. to EN 60825-1)
 Standards applied IEC 60947-5-2

Options

Switching delay (slow oper./release) 0 ... 10s (separately adjustable)
 Activation input activ (high) ≥ 8V / ≤ 2V
 Transmitter active/not active ≤ 0.5ms
 Activation/disable delay 47KΩ ± 10%
 Input resistance

- 1) Typ. scanning range limit: max. attainable range without performance reserve
- 2) Scanning range: recommended range with performance reserve
- 3) 1=transient protection, 2=polarity reversal protection, 3=short circuit protection for all outputs, 4=interference blanking
- 4) Rating voltage 250VAC

Tables

Red light

1	100	800	1200
2	100	770	1140
3	100	730	1050

1	white 90%
2	grey 18%
3	black 6%

Scanning range [mm]
 Typ. scanning range limit [mm]

Diagrams

Typ. response behaviour (white 90%)

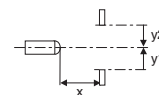
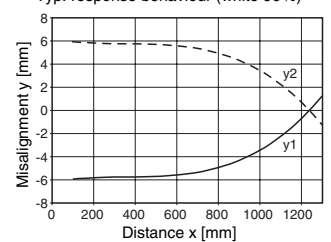

Typ. black/white behaviour

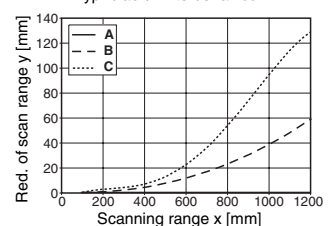

- A white 90%
- B grey 18%
- C black 6%

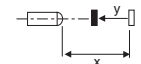

Order guide

Selection table		Order code →									
Equipment ↓		HRT 96K/P-1630-800-41 Part No. 500 80242	HRT 96K/P-1630-800-21 Part No. 500 80327	HRT 96K/P-1640-800-41 Part No. 500 81464	HRT 96K/P-1631-800-47 Part No. 500 38471						
Light source	red light (800mm)	●	●	●	●						
	infrared light (1200mm)										
Connection	terminals		●								
	M12 connector	●		●	●						
Features	switching delay			●							
	activation input				●						
	UL homologation	●	●	●	●						

Remarks

- With the set scanning range, a tolerance of the upper scanning range limit is possible depending on the reflection properties of the material surface.
- The diffuse reflection light scanner is also available with integrated AS-i chip for direct connection to the AS-i system.
- Available as a set together with cable socket.