

HT49C RELAIS Diffuse reflection light scanners with background suppression

en 02-2015/08 50128462-01

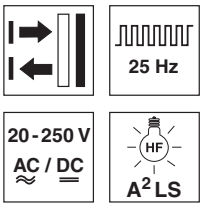

5 ... 3000 mm
1200mm with
black-white error < 10%

- Scanner with adjustable background suppression in red light and infrared light version
- Reliable detection of objects with different surface structures
- Robust plastic housing, degree of protection IP 67 and IP 69K for universal, industrial application
- All-mains design 20 ... 250VAC/DC with relay output (potential-free)
- Large adjustment range and minimal zero distance for optimum adaptation to the application
- Light/dark switching and time module activation via teach button for time-saving integration in existing evaluation environment:
- Space-saving installation thanks to front access to the connection compartment
- Extremely time-saving connection by means of spring terminals (up to 1.5mm²)
- A²LS - Active Ambient Light Suppression
- Optics heating



Accessories:

(available separately)

- Mounting systems (BTU 460, BT 96, BT 96.1, BT 450.1-96)
- Spark extinction

Dimensioned drawing

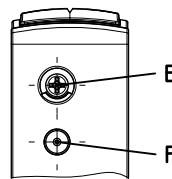
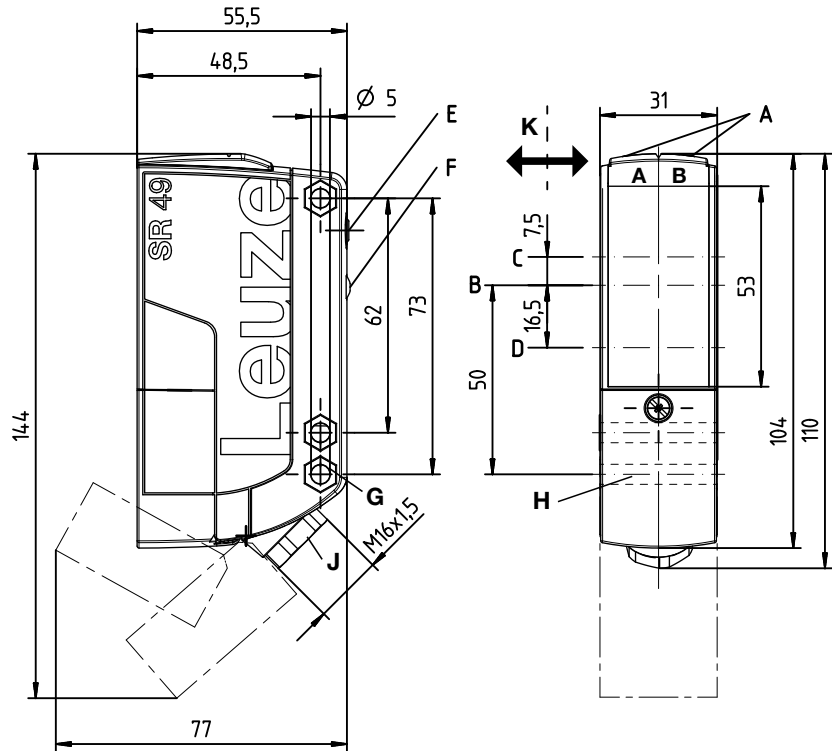

- A_A** Green indicator diode
- A_B** Yellow indicator diode
- B** Optical axis
- C** Receiver
- D** Transmitter
- E** Scanning range adjustment
- F** Teach button for light/dark switching / time module activation
- G** Countersinking for SK nut M5, 4.2 deep
- H** Connection compartment with spring terminals
- J** Cable entry with M16x1.5 screw fitting for Ø5 ... 10mm
- K** Preferred entry direction

Electrical connection

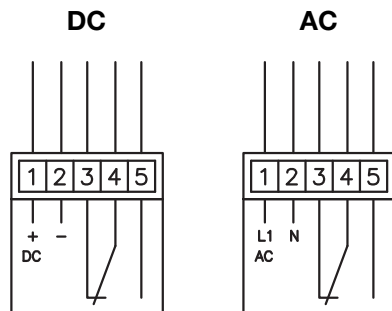

Wire color of connecting cable

Pin	Color
1	BR / BN
2	BL / BU
3	WS / WH
4	GR / GY
5	SW / BK

We reserve the right to make changes • DS_HT49CUCTS_en_50128462_01.fm

Specifications

Optical data

Typ. scanning range limit (white 90%) ¹⁾
 Scanning range ²⁾
 Black-white error
 Adjustment range
 Light source
 Wavelength

HT49C...

5 ... 3000mm
 see diagrams
 <10% up to 1200mm
 120 ... 3000mm
 LED (modulated light)
 630nm (red light)

HT49CI...

860nm (infrared light)

Timing

Switching frequency 25Hz
 Response time 20ms
 Delay before start-up ≤ 300ms

Electrical data

Operating voltage U_B 20 ... 250VAC, 50/60Hz
 20 ... 250VDC
 ≤ 1.5VA
 Power consumption relay, 1 change-over contact
 Switching output ³⁾ break-contact/make-contact
 Function 250VAC/DC
 Switching voltage, relay 250VAC, 2.5A/30VDC, 2.5A
 Switching current, relay 625VA, cosφ=1
 Switching power, relay adjustable
 Scanning range

Indicators

Green LED ready
 Yellow LED reflection

Mechanical data

Housing polycarbonate
 Optics cover plastic
 Weight 150g
 Connection type spring terminals, max. wire cross section 1.5mm²
 cable 2000mm, 5 x 0.5mm²

Environmental data

Ambient temp. (operation/storage) -40°C ... +60°C/-40°C ... +70°C
 Protective circuit ⁴⁾ 1, 4
 VDE safety class ⁵⁾ II, all-insulated
 Degree of protection IP 67, IP 69K ⁶⁾
 Light source exempt group (in acc. with EN 62471)
 Standards applied IEC 60947-5-2

Options

Switching function (teach level 1) light switching (factory setting) or dark switching
 Time module (teach level 2) active: dropout delay 500ms
 not active: no dropout delay (factory setting)

Optics heating

Current consumption approx. 70mA at 20VDC

- 1) Typ. scanning range limit: max. attainable range without performance reserve
- 2) Scanning range: recommended range with performance reserve
- 3) Suitable spark extinction (snubber) must be provided with inductive or capacitive loads.
- 4) 1=transient protection, 4=interference blanking
- 5) Rating voltage 250VAC
- 6) IP 69K test acc. to DIN 40050 part 9 simulated, high pressure cleaning conditions without the use of additives, acids and bases are not part of the test

Remarks

Operate in accordance with intended use.

- ☞ This product is not a safety sensor and is not intended as personnel protection.
- ☞ The product may only be put into operation by competent persons.
- ☞ Only use the product in accordance with the intended use.

- With the set scanning range, a tolerance of the upper scanning range limit is possible depending on the reflection properties of the material surface.

Tables

1	5	3000
2	20	2000
3	50	1500

1	white 90%
2	gray 18%
3	black 6%

☐ Scanning range [mm]

Diagrams

HT49C... with red light

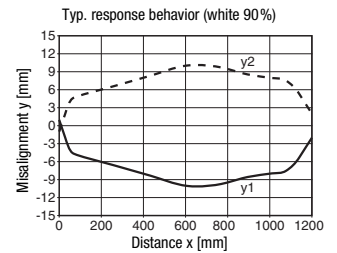

HT49CI... with infrared light

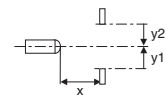
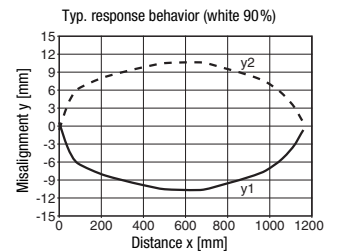

HT49C... with red light

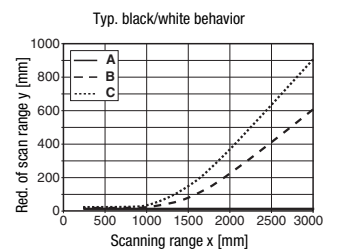

HT49CI... with infrared light

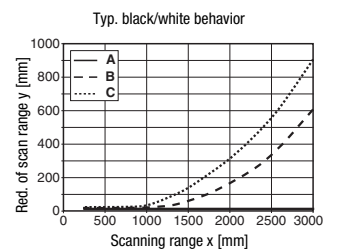

- A white 90%
- B gray 18%
- C black 6%

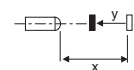

HT49C RELAIS Diffuse reflection light scanners with background suppression

Part number code

H	T	4	9	C	I	.	U	C	H	/	T	S	-	T	B
---	---	---	---	---	---	---	---	---	---	---	---	---	---	---	---

Operating principle

HT Diffuse reflection light scanners with background suppression

Series

49C 49C series

Light type

I Infrared light

free Red light

Operating voltage

UC 20 ... 250VAC/DC (all-mains design)

Equipment

H Optics heating

Setting

free Mechanical scanning range adjustment, teach button (light/dark switching, time module activation)

Switching output

TS Relay, normally closed contact/normally open contact (NC/NO)

M4 Low-impedance MOSFET semiconductor switching output, normally open contact (NO)

Connection technology

TB Terminal block - terminal compartment with spring terminals (5 x 1.5mm²)

free Cable 2000mm

Order guide

The sensors listed here are preferred types; current information at www.leuze.com.

All-mains designs with relay output

Designation

Part no.

Terminal compartment with spring terminals (5 x 1.5mm²)

Red light

HT49C.UC/TS-TB

50127193

Infrared light

HT49CI.UC/TS-TB

50127433

Red light, optics heating

HT49C.UCH/TS-TB

50130470

Infrared light, optics heating

HT49CI.UCH/TS-TB

50130471

Cable, cable length 2m

Red light

HT49C.UC/TS

50127430

Infrared light

HT49CI.UC/TS

50127434

Teach procedure for sensor



Note

Factory setting: **light switching, time module not active**

Light/dark switching

Setting the switching behavior of the relay output

Teach level 1	<p>Press teach button (2 to 7s) until both LEDs (green/yellow) flash synchronously. Release teach button – switchover is complete.</p> <p>The yellow LED then indicates the current setting of the switching output for 3s:</p> <p>ON = light switching = output between pin 4 and pin 3: normally closed contact (NC) output between pin 4 and pin 5: normally open contact (NO)</p> <p>OFF = dark switching = output between pin 4 and pin 3: normally open contact (NO) output between pin 4 and pin 5: normally closed contact (NC)</p>	<p>2 ... 7s</p> 
----------------------	---	---

Activation/deactivation of the time module

Setting a dropout delay for the relay output

Teach level 2	<p>Press teach button (7 to 12s) until both LEDs (green/yellow) flash alternately. Release teach button – activation/deactivation is complete.</p> <p>The yellow LED then indicates the current setting of the dropout delay for 3s:</p> <p>ON = time module not active = no dropout delay for the relay</p> <p>OFF = time module active = dropout delay for the relay: 500ms ¹⁾</p> <p><small>1) Additional models on request</small></p>	<p>7 ... 12s</p> 
----------------------	---	--

Dropout delay: if the object is no longer present, the output switches with a time delay.