

**HTU418B**

**ADVANCED ultrasonic sensors with 2 switching outputs**

en 05-2015/10 50124879



**25 ... 400mm**  
**150 ... 1300mm**



- Function largely independent of surface properties, ideal for detection of liquids, bulk materials, transparent media, ...
- Small dead zone at long scanning range
- Temperature-compensated scanning range
- 2 independent PNP switching outputs
- **NEW** – Both outputs can easily be taught using a button
- **NEW** – Stable, all-metal design
- **NEW** – Process data and configuration via IO-Link interface
- **NEW** – Five operating modes: scanning, synchronous, multiplex, activation and throughbeam operation

We reserve the right to make changes • DS\_HTU418BX3LT4\_en\_50124879.fm

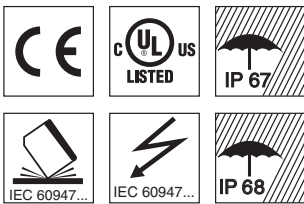

**Accessories:**

(available separately)

- Mounting systems
- Mounting adapter M18-M30: BTX-D18M-D30 (Part no. 50125860)
- Cables with M12 connector (K-D ...)
- Teach adapter PA1/XTSX-M12 (Part no. 50124709)
- USB IO-Link master 2.0 (Part no. 50121098)

**Dimensioned drawing**

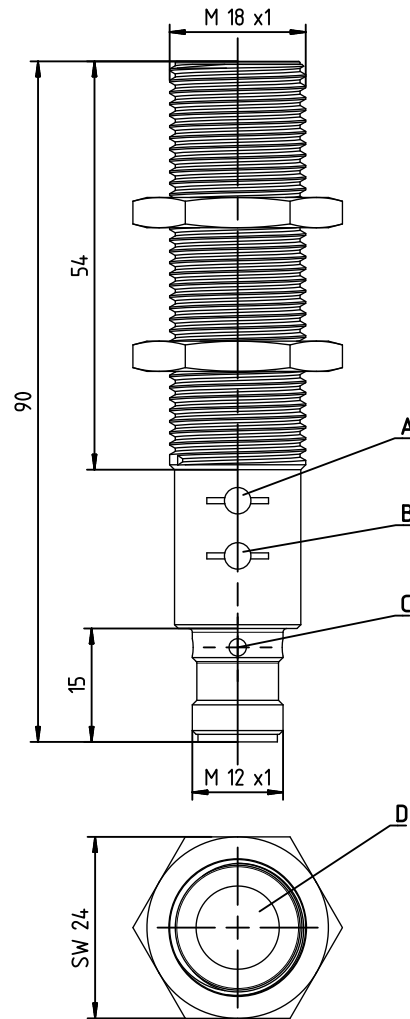

- A** Control button 2
- B** Control button 1
- C** Indicator diodes
- D** Active sensor surface

**Electrical connection**

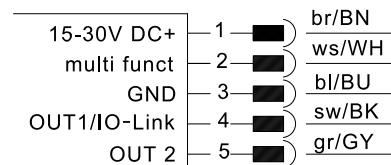

Factory setting for pin 2 **multi funct**: teach input

## Specifications

### Ultrasonic specifications

Scanning range <sup>1)</sup>  
 Adjustment range  
 Ultrasonic frequency  
 Typ. opening angle  
 Resolution  
 Direction of beam  
 Accuracy  
 Reproducibility  
 Switching hysteresis  
 Temperature drift

### HTU418B-400.X3/...

25 ... 400mm<sup>2)</sup>  
 25 ... 400mm  
 310kHz  
 9°  
 1mm  
 axial  
 ± 0.5% of end value <sup>1)</sup>  
 ± 0.15% of end value <sup>1)</sup>  
 5mm  
 ± 1.5% of end value <sup>1)</sup>

### HTU418B-1300.X3/...

150 ... 1300mm<sup>3)</sup>  
 150 ... 1300mm  
 200kHz  
 16°  
 1mm  
 axial  
 ± 0.5% of end value <sup>1)</sup>  
 ± 0.15% of end value <sup>1)</sup>  
 10mm  
 ± 1.5% of end value <sup>1)</sup>

### Sensor operating modes

IO-Link  
 SIO

COM2 (38.4kBaud)  
 is supported

### Timing

Switching frequency  
 Response time  
 Delay before start-up

7Hz  
 71ms  
 < 300ms

8Hz  
 62ms  
 < 300ms

### Electrical data

Operating voltage  $U_B$  <sup>4)</sup>

Residual ripple  
 Open-circuit current  
 Switching output

Function (PNP)  
 Output current

Switching range adjustment

Changeover NO/NC

SIO mode: 15 ... 30V DC (incl. ± 10% residual ripple),  
 COM2 mode: 18 ... 30V DC (incl. ± 10% residual ripple)  
 ± 10% of  $U_B$   
 ≤ 50mA

OUT1: 1 x PNP transistor, IO-Link SIO mode  
 OUT2: 1 x PNP transistor, configurable  
 2 x NO contact, reversible  
 SIO mode: max. 150mA per contact,  
 COM2 mode: max. 100mA per contact  
 OUT1: control button 1 or teach input  
 OUT2: control button 2 or teach input  
 OUT1: control button 1 or teach input  
 OUT2: control button 2 or teach input

### Indicators

Yellow LED  
 Yellow LED, flashing  
 Green LED  
 Green LED flashing

OUT1: object detected  
 teach-in / teaching error / cable short circuit  
 object within the scanning range  
 IO-Link communication

### Mechanical data

Housing  
 Weight  
 Ultrasonic transducer  
 Connection type  
 Fitting position

all metal - brass, nickel-plated  
 50g  
 piezoceramic <sup>5)</sup>  
 M12 connector, 5-pin  
 any

### Environmental data

Ambient temp. (operation/storage)  
 Protective circuit <sup>6)</sup>  
 VDE safety class  
 Degree of protection  
 Standards applied  
 Certifications

-25°C ... +70°C/-30°C ... +85°C  
 1, 2, 3  
 III  
 IP 67 and IP 68  
 EN 60947-5-2  
 UL 508, C22.2 No.14-13 <sup>4) 7)8)</sup>

- 1) At 20°C
- 2) Target: 20mm x 20mm plate
- 3) Target: 100mm x 100mm plate
- 4) For UL applications: for use in class 2 circuits according to NEC only
- 5) The ceramic material of the ultrasonic transducer contains lead zirconium titanate (PZT)
- 6) 1=short-circuit and overload protection, 2=polarity reversal protection, 3=wire break and inductive protection
- 7) These proximity switches shall be used with UL Listed Cable assemblies rated 30V, 0.5A min, in the field installation, or equivalent (categories: CYJV/CYJ7 or PVVA/PVVA7); Use tool for buttons
- 8) Ambient temperature 85°C. Use same voltage supply for all circuits.

## Remarks

### Operate in accordance with intended use!

- ⚠ This product is not a safety sensor and is not intended as personnel protection.
- ⚠ The product may only be put into operation by competent persons.
- ⚠ Only use the product in accordance with the intended use.

## Diagrams

### HTU418B-400...-M12

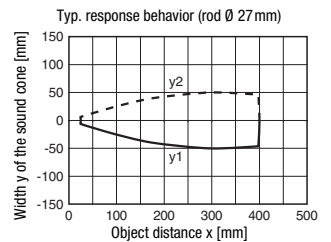
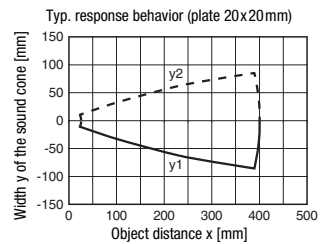

### HTU418B-1300...-M12

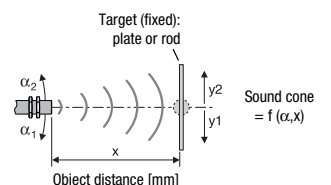
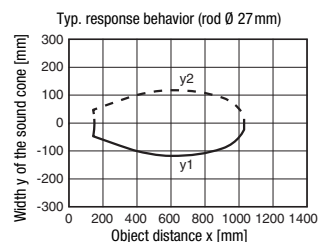
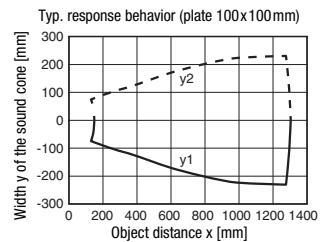
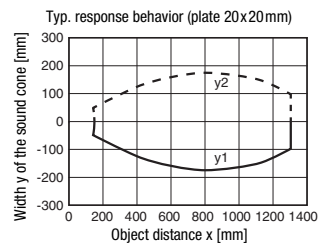

# HTU418B

# ADVANCED ultrasonic sensors with 2 switching outputs

## Part number code

H T U 4 1 8 B - 1 3 0 0 . X 3 / L T 4 - M 1 2

### Operating principle

**HTU** Ultrasonic sensor, scanning principle, with background suppression

**DMU** Ultrasonic sensor, distance measurement

### Series

**418B** 418B Series, cylindrical M18 construction

### Scanning range in mm

**400** 25 ... 400

**1300** 150 ... 1300

### Equipment (optional)

**X** "Advanced" design

**3** Teach button on the sensor

### Pin assignment of connector pin 4 / black cable wire (OUT1)

**4** PNP output, NO contact preset

**P** PNP output, NC contact preset

**L** IO-Link communication or push-pull (SIO)

### Pin assignment of connector pin 2 / white cable wire (Teach-IN)

**T** Teach input

### Pin assignment of connector pin 5 / gray cable wire (OUT2)

**4** PNP output, NO contact preset

**P** PNP output, NC contact preset

**V** Analog voltage output 0 ... 10V

**C** Analog current output 4 ... 20mA

**X** Connection not assigned (n. c. - not connected)

### Connection technology

**M12** M12 connector, 5-pin

## Order guide

The sensors listed here are preferred types; current information at [www.leuze.com](http://www.leuze.com).

	Designation	Part no.
<b>Scanning range</b>		
25 ... 400mm	HTU418B-400.X3/LT4-M12	50124267
150 ... 1300mm	HTU418B-1300.X3/LT4-M12	50124271

### Device functions and indicators

The sensor has two buttons for adjusting output **OUT1** and output **OUT2**. Alternatively, all adjustments can also be made via **IO-Link**. The **multi funct** teach input can be used to perform the 1-point teach and the changeover of the switching function (NO contact/NC contact).

### Switching behavior

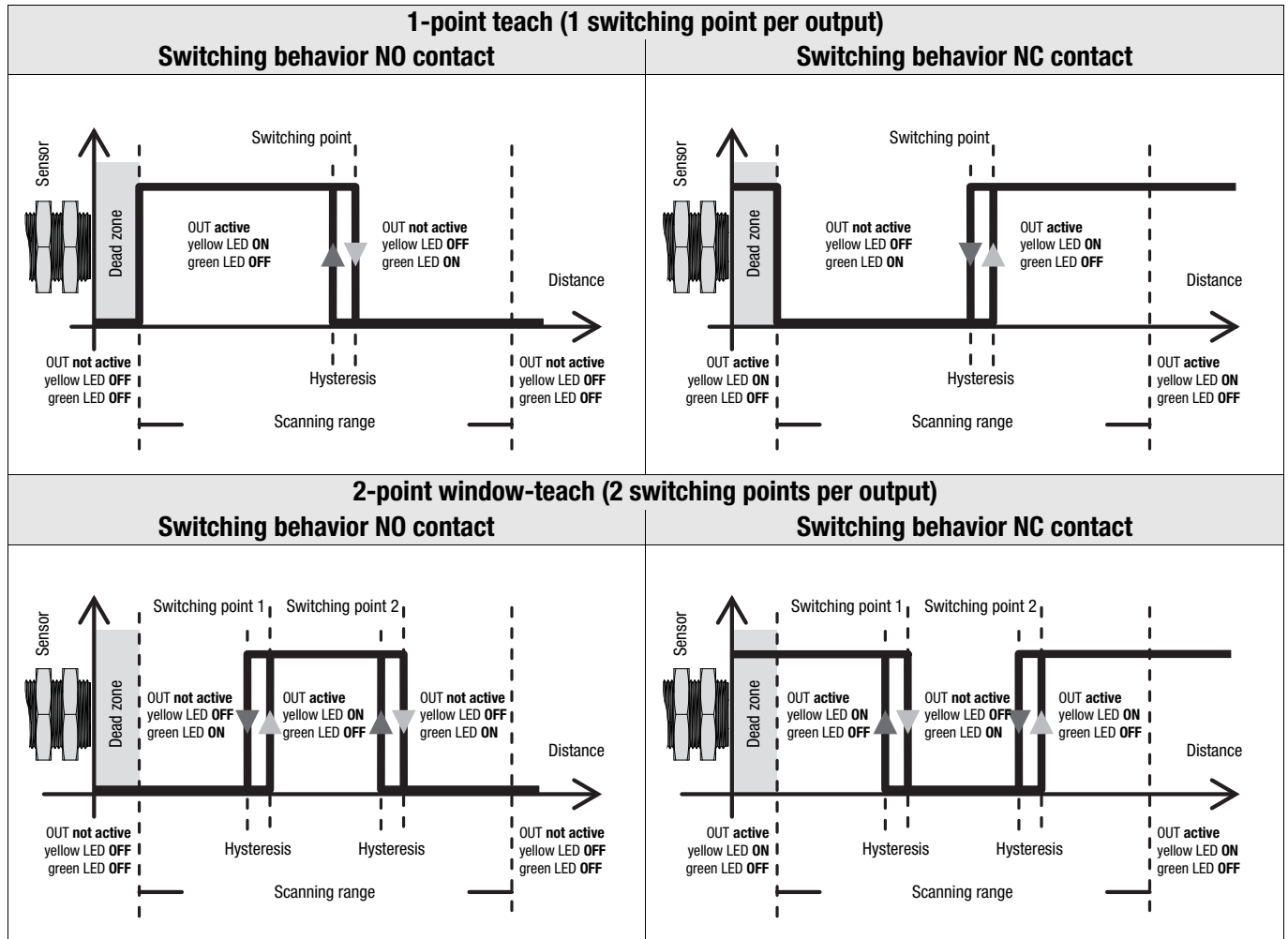

**Notice!**  
The switching behavior is not defined in the dead zone.

### Switching behavior with 2-point window-teach as a function of the switching function

Switching function configured as	First taught object distance	Second taught object distance	Output switching behavior
NO contact NC contact	Far	Close	
	Close	Far	



**Notice!**  
In measurement operation, the yellow and green LED only indicate the behavior of output **OUT1**. The behavior of output **OUT2** is not indicated.

The 2-point window-teach can be configured either with the control buttons or via the IO-Link interface. Adjustment via the teach input is not possible.

## Adjustment of the switching points (Teach) using the control buttons

The two switching points of the sensor are both set to 400mm or 1300mm (static 1-point teach) on delivery.

By means of a simple operating procedure, the switching points for each output can be individually taught to an arbitrary distance within the scanning range with 1-point teach (static) or 2-point window-teach (static).

Moreover, the output function can be switched from NO contact (NO - normally open) to NC contact (NC - normally closed). For the adjustment, an individual control button is permanently assigned to each output (see dimensioned drawing).

1-point teach (static)	2-point window-teach (static) <sup>1)</sup>
<b>1. Place</b> object at desired switching distance.	<b>1. First, place</b> object at desired switching distance for <b>switching point 1</b> .
<b>2. To adjust output OUT1, press button 1, to adjust output OUT2, press button 2 for 2 ... 7s until the yellow LED flashes at 3Hz.</b>	<b>2. To adjust output OUT1, press button 1, to adjust output OUT2, press button 2 for 7 ... 12s until the yellow and green LED flash alternately at 3Hz.</b>
<b>3. Release the button</b> at the end of the teach event. The current object distance has been taught as the new switching point.	<b>3. Release button.</b> The sensor remains in teach mode and the LEDs continue to flash.
<b>4. Error-free teach: LED states and switching behavior according to the diagram shown above.</b> <b>Faulty teach</b> (object may be too close or too far away – please note scanning range): <b>yellow LED flashes at 5Hz</b> until an error-free teach event is performed. The affected output is inactive as long as there is a teach error.	<b>4. Then, place</b> the object at the desired switching distance for <b>switching point 2</b> . <b>Notice:</b> The <b>minimum distance between the switching points</b> is as follows: scanning range of 400mm: <b>40mm</b> scanning range of 1300mm: <b>130mm</b>
	<b>5. Briefly press</b> the <b>button</b> again at the end of the teach event. The switching window has been taught.
	<b>6. Error-free teach: LED states and switching behavior according to the diagram shown above.</b> <b>Faulty teach</b> (object may be too close or too far away – please note scanning range): <b>green and yellow LED flash at 8Hz</b> until an error-free teach event is performed.

1) See table "Switching behavior with 2-point window-teach as a function of the switching function"

**Notice!**

All operating functions are identical for outputs OUT1 and OUT2.

## Adjustment of the switching function (NO/NC) using the control buttons

The control buttons can be used to switch the output function from NO contact to NC contact (or vice versa).

To do this, proceed as follows:

Action / Description	Control button	Indicator diode	
		GREEN	YELLOW
<b>Changeover of the switching function:</b> Switching outputs <b>OUT1</b> and <b>OUT2</b> are set as <b>NO contact ex works</b> . If the switching function is changed, the corresponding switching output is changed to the opposite state (toggled).	<b>Press the button</b> for the desired switching output <b>for longer than 12s</b> .	<b>Both LEDs flash alternately</b> for a short time at 3Hz. If the <b>yellow LED</b> is then <b>ON</b> , the output functions as an <b>NO contact</b> . If the <b>yellow LED</b> is then <b>OFF</b> , the output functions as an <b>NC contact</b> .	

**Notice!**

For 2-point window-teach, the switching behavior is dependent on the selected object distances for switching points 1 and 2. See previous page!

## Adjusting the switching points (teach) via the teach input

The switching points of the sensor outputs **OUT1/OUT2** are set to 400mm or 1300mm on delivery.

By means of a simple teach event, the two switching points can be individually taught to an arbitrary distance within the scanning range. The Leuze **PA1/XTSX-M12** teach adapter can be used for this purpose. The adapter can also be used to easily switch the output function from NO contact to NC contact.

1-point teach of output <b>OUT1</b>	1-point teach of output <b>OUT2</b>
<b>1. Place</b> object at desired switching distance.	<b>1. Place</b> object at desired switching distance.
<b>2. For the adjustment of output <b>OUT1</b>, connect input <b>Teach-IN</b> to <b>GND</b> for 2 ... 7s</b> (Leuze teach adapter: position "Teach-GND"). The current state of output <b>OUT1</b> is frozen during the teach event.	<b>2. For the adjustment of output <b>OUT2</b>, connect input <b>Teach-IN</b> to <b>GND</b> for 7 ... 12s</b> (Leuze teach adapter: position "Teach-GND"). The current state of output <b>OUT2</b> is frozen during the teach event.
<b>3. The yellow LED flashes at 3Hz and then remains on.</b> The current object distance has been taught as the new switching point.	<b>3. The yellow LED flashes at 3Hz.</b> The current object distance has been taught as the new switching point.
<b>4. Error-free teach:</b> switching behavior according to the diagram shown above. <b>Faulty teach</b> (object may be too close or too far away – please note scanning range): <b>yellow LED flashes at 5Hz</b> until an error-free teach event is performed. The output <b>OUT1</b> is inactive as long as there is a teach error.	<b>4. Error-free teach:</b> switching behavior according to the diagram shown above. <b>Faulty teach</b> (object may be too close or too far away – please note scanning range): <b>yellow LED flashes at 5Hz</b> until an error-free teach event is performed. The output <b>OUT2</b> is inactive as long as there is a teach error.



### Notice!

Please note that **the switching point is taught when GND is connected and the output function is reversed when  $U_B$  is connected. If no sensor action is desired, pin 2 must remain unconnected!**

**The 2-point window-teach can be configured either with the control buttons or via the IO-Link interface. Adjustment via the teach input is not possible.**

## Adjusting the switching function (NC/NO) via the teach input

The switching function of both sensor outputs is set to normally open (NO) on delivery.

If the switching function is changed, the switching output is changed to the opposite state (toggled).

Changeover of the switching function of output <b>OUT1</b>	Changeover of the switching function of output <b>OUT2</b>
<b>1. To change the switching function, connect input <b>Teach-IN</b> to <math>U_B</math> for 2 ... 7s</b> (Leuze teach adapter: position "Teach- $U_B$ "). The current state of output <b>OUT1</b> remains frozen while the adjustment is performed.	<b>1. To change the switching function, connect input <b>Teach-IN</b> to <math>U_B</math> for 7 ... 12s</b> (Leuze teach adapter: position "Teach- $U_B$ "). The current state of output <b>OUT2</b> remains frozen while the adjustment is performed.
<b>2. The green and yellow LED flash alternately at 2Hz.</b> The switching function has been reversed. The switching behavior corresponds to the diagram shown above.	<b>2. The green and yellow LED flash alternately at 5Hz.</b> The switching function has been reversed. The switching behavior corresponds to the diagram shown above.

## IO-Link interface

The ultrasonic sensor features an IO-Link interface acc. to specification V1.1. and satisfies the Smart Sensor Profile.

As a result, the sensor can easily, quickly and, thus, economically be configured and diagnostic information read out. With a small amount of effort, the sensor can also be integrated in a control.

### Overview of the configuration options via IO-Link

Function block	Function	Description
<b>Operating mode</b>	Standard operation	The sensor operates as a scanner with background suppression.
	Multiplex operation	A max. of 10 sensors – 1 master and 9 slaves – can be wired together in a network. To do this, the sensors must be electrically connected with one line. The master generates a timing signal and all networked sensors are activated with time-delay.
	Synchronous operation	A max. of 10 sensors – 1 master and 9 slaves – can be wired together in a network. To do this, the sensors must be electrically connected with one line. The master generates a timing signal and all networked sensors are activated simultaneously.
	Activation operation	The sensor can be activated through an external signal.
	Operation as throughbeam sensor	The sensor can either be configured as a scanner or as a throughbeam sensor. Operation as a throughbeam sensor requires 2 sensors, which are electrically connected through one line.
<b>Switching outputs OUT1 / OUT2</b>	Switching point 1/2	The switching points can be directly entered as distance value in mm.
	Switching output (OUT1 and OUT2)	Adjustment as PNP or NPN switching output
	Switching function	Adjustment as NC / NO contact.
	Switching behavior in the case of error	The switching behavior of output OUT1 of the sensor, for objects which are located outside of the scanning range, can be adjusted.
	2-point behavior	If a switching output is to operate with 2 switching points, a choice can be made between 2-point window-teach (factory setting) or 2-point teach (e.g. for simple pump controls with minimum and maximum fill levels).
	Teach switching output OUT1	The switching output OUT1 can be taught via the IO-Link interface.
	Teach lock	Adjustment for locking of control buttons
<b>Temperature</b>	Temperature compensation	Adjustment option for internal (sensor works with the integrated temperature sensor) or external (with a constant application temperature, this can be manually entered. The sensor then compensates the measured values at a fixed rate with this temperature).
	Unit	Adjustment option to °C or °F.
	Temperature value	Entry temperature value in °C or °F (if external temperature compensation is desired).

In addition to the configuration functions, a range of sensor information, such as sensor status, sensor diagnostics as well as the process data, can be called up.

Further information and the device-specific description of the IO-Link interface (**IODD**) can be found on the Internet at [www.leuze.com](http://www.leuze.com) in the **Downloads** area of the respective sensor.

