

HT46C(I).SL "Roller conveyor"

Diffuse reflection sensor with background suppression

en 01-2015/11 50130090

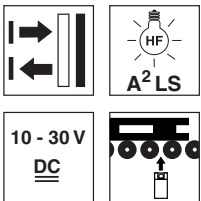

10 ... 1200mm
800mm with
black-white error < 10%

- Reliable detection of objects between the rollers of a roller conveyor
- Reliable detection of light and dark, as well as inclined or sloped surfaces
- Reliable detection of objects which have undefined heights and of objects which extend over pallet edges.
- Exact switching point adjustment through mechanical adjusting spindle
- Extremely high repeatability of the switching point
- Various switching output functions for universal connection to existing control environment
- A²LS active ambient light suppression for avoiding mutual interference
- Robust plastic housing in degrees of protection IP67 and IP69K

We reserve the right to make changes • DS_HT46CI_SL_en_50130090.fm



Accessories:

(available separately)

- Mounting systems (BT 46, BTU 300M, BT 300, BTU 346)
- M12 connectors (KD ...)
- Ready-made cables (K-D ...)

Dimensioned drawing

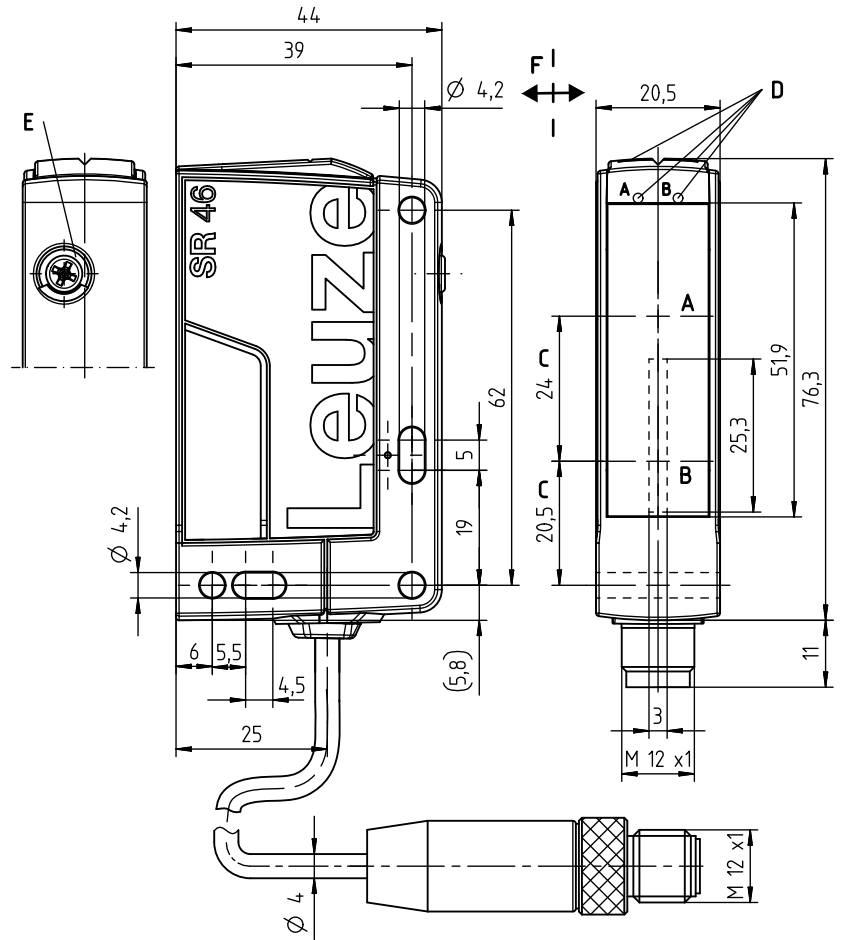

- A** Receiver
- B** Transmitter
- C** Optical axis
- DA** Green indicator diode
- DB** Yellow indicator diode
- E** Scanning range adjustment
- F** Preferred movement for objects

Electrical connection

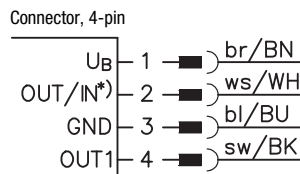

Selection pin 2

*)	OUT	IN
	OUT 2	Active
	Warn	
	NC	

Specifications

Optical data

Typ. scanning range limit (white 90%) ¹⁾
 Scanning range ²⁾
 Black-white error
 Scanning range adjustment
 Adjustment range
 Light source ³⁾
 Wavelength
 Light spot

HT46C(I).SL...

10 ... 1200mm, see tables
 see diagrams
 <10% up to 800mm
 mechanical adjusting spindle
 120 ... 1200mm
 LED (modulated light)
 860nm (infrared light)
 see tables

HT46C.SL...

630nm (red light)

Timing

Switching frequency 250Hz
 Response time 2ms
 Readiness delay ≤ 300ms

Electrical data

Operating voltage U_B ⁴⁾ 10 ... 30VDC (incl. residual ripple)
 Residual ripple ≤ 15% of U_B
 Open-circuit current ≤ 30mA
 Switching outputs/functions ⁵⁾ /4P 2 PNP switching outputs, antivalent
 /4X 1 PNP switching output, light switching
 /PX 1 PNP switching output, dark switching
 /2N 2 NPN switching outputs, antivalent
 Signal voltage high/low ≥ ($U_B - 2V$) / ≤ 2V
 Output current max. 100mA

Indicators

Green LED ready
 Yellow LED reflection
 Yellow LED, flashing reflection, no function reserve

Mechanical data

Housing plastic
 Optics cover plastic
 Weight with M12 connector: approx. 60g
 with 200mm cable and M12 connector: approx. 65g
 M12 connector, 4-pin
 cable 200mm with M12 connector, 4-pin
 Connection type

Environmental data

Ambient temp. (operation/storage) -40°C ... +60°C / -40°C ... +70°C
 Protective circuit ⁶⁾ 2, 3
 VDE safety class ⁷⁾ II, all-insulated
 Degree of protection IP 67, IP 69K
 Light source exempt group (in acc. with EN 62471)
 Standards applied IEC 60947-5-2
 Certifications UL 508, CSA C22.2 No.14-13 ⁴⁾ ⁸⁾

- 1) Typ. scan. range limit: max. achievable scanning range for light objects (white 90%)
- 2) Scanning range: recommended scanning range for objects with different diffuse reflection
- 3) Average life expectancy 100,000 h at an ambient temperature of 25°C
- 4) For UL applications: for use in class 2 circuits only
- 5) See part number code
- 6) 2=polarity reversal protection, 3=short circuit protection for all transistor outputs
- 7) Rating voltage 50V
- 8) These proximity switches shall be used with UL Listed Cable assemblies rated 30V, 0.5A min, in the field installation, or equivalent (categories: CYJV/CYJV7 or PVVA/PVVA7)

Tables

Typical scanning range limit

1	10	1200
2	15	1000
3	20	800

1	white 90%
2	gray 18%
3	black 6%

Typical light spot

Distance x	Typ. light-spot size
50mm	24mm x 3mm
100mm	24mm x 4mm
200mm	24mm x 5mm
300mm	25mm x 7mm
500mm	25mm x 10mm

Diagrams

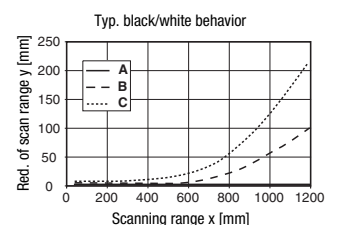
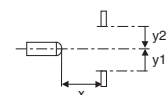
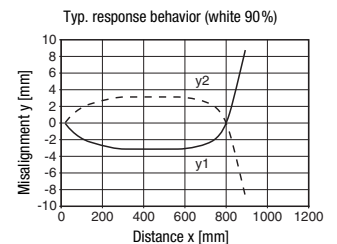

- A white 90%
- B gray 18%
- C black 6%

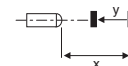

Remarks

Operate in accordance with intended use!

- ⚠ This product is not a safety sensor and is not intended as personnel protection.
- ⚠ The product may only be put into operation by competent persons.
- ⚠ Only use the product in accordance with the intended use.

HT46C(I).SL "Roller conveyor" Diffuse reflection sensor with background suppression

Part number code

H	T	4	6	C	I	.	S	L	/	4	X	-	2	0	0	-	M	1	2
---	---	---	---	---	---	---	---	---	---	---	---	---	---	---	---	---	---	---	---

Operating principle

HT Diffuse reflection sensor with background suppression

Series

46C 46C series

Light type

Free Red light

I Infrared light

Setting

Free Scanning range adjustment via mechanical adjusting spindle

Function

SL With slit diaphragm 25 mm x 3 mm

Pin assignment of OUT1 (connector pin 4 / black cable wire)

2 NPN, light switching

N NPN, dark switching

4 PNP, light switching

P PNP, dark switching

Pin assignment of OUT/IN (connector pin 2 / white cable wire)

X Not assigned

2 NPN, light switching

N NPN, dark switching

4 PNP, light switching

P PNP, dark switching

8 Activation input (active high)

W Warning output, PNP light switching

Connection technology

M12 M12 connector, 4-pin

200-M12 Cable 200 mm with M12 connector, 4-pin

Free Cable 2000 mm

Order guide

The sensors listed here are preferred types; current information at www.leuze.com.

Diffuse reflection sensor with background suppression, with slit diaphragm 25mm x 3mm	Designation	Part no.
Infrared light		
With M12 connector, 4-pin		
OUT1: PNP light switching; OUT2: PNP dark switching	HT46CI.SL/4P-M12	50131551
Cable 0.2m with M12 connector, 4-pin		
OUT1: PNP light switching; OUT2: no contact ¹⁾	HT46CI.SL/4X-200-M12	50131554
Red light		
With M12 connector, 4-pin		
OUT1: PNP light switching; OUT2: PNP dark switching	HT46C.SL/4P-M12	50131553
Cable 0.2m with M12 connector, 4-pin		
OUT1: PNP light switching; OUT2: no contact ¹⁾	HT46C.SL/4X-200-M12	50131552

1) Direct connection to AS-i coupling modules possible