

HTU430B

ADVANCED ultrasonic sensors with 2 switching outputs

en 02-2015/10 50125024



Dimensioned drawing

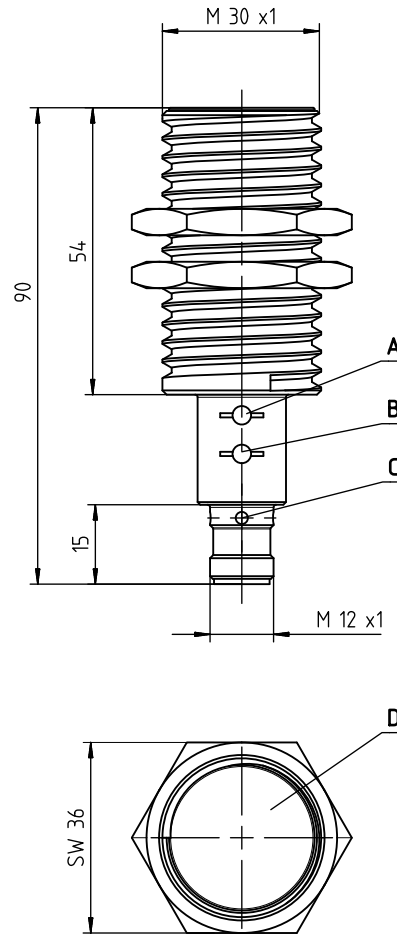

- A** Control button 2
- B** Control button 1
- C** Indicator diodes
- D** Active sensor surface



300 ... 3000 mm



- Function largely independent of surface properties, ideal for detection of liquids, bulk materials, transparent media, ...
- Small design at long scanning range
- Temperature-compensated scanning range
- 2 independent PNP switching outputs
- **NEW** – Both outputs can easily be taught using a button
- **NEW** – Stable, all-metal design
- **NEW** – Process data and configuration via IO-Link interface
- **NEW** – Five operating modes: scanning, synchronous, multiplex, activation and throughbeam operation

Electrical connection

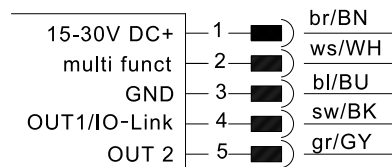

Factory setting for pin 2 **multi funct**: teach input

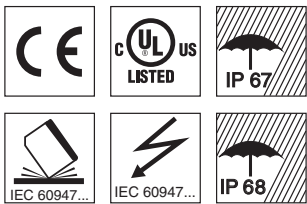

Accessories:

(available separately)

- Mounting systems
- Cables with M12 connector (K-D ...)
- Teach adapter PA1/XTSX-M12 (Part no. 50124709)
- USB IO-Link master 2.0 (Part no. 50121098)

We reserve the right to make changes • DS_HTU430BX3LT4_en_50125024.fm

Specifications

Ultrasonic specifications

Scanning range ¹⁾	300 ... 3000mm ²⁾
Adjustment range	300 ... 3000mm
Ultrasonic frequency	120kHz
Typ. opening angle	15°
Resolution	1mm
Direction of beam	axial
Accuracy	± 0.5% of end value ¹⁾
Reproducibility	± 0.15% of end value ¹⁾
Switching hysteresis	25mm
Temperature drift	± 1.5% of end value ¹⁾

Sensor operating modes

IO-Link	COM2 (38.4kBaud)
SIO	is supported

Timing

Switching frequency	4Hz
Response time	125ms
Delay before start-up	< 300ms

Electrical data

Operating voltage U_B ³⁾	SIO mode: 15 ... 30V DC (incl. ± 10% residual ripple), COM2 mode: 18 ... 30V DC (incl. ± 10% residual ripple)
Residual ripple	± 10% of U_B
Open-circuit current	≤ 50mA
Switching output	OUT1: 1 x PNP transistor, IO-Link SIO mode OUT2: 1 x PNP transistor, configurable
Function (PNP)	2 x NO contact, reversible
Output current	SIO mode: max. 150mA per contact, COM2 mode: max. 100mA per contact
Switching range adjustment	OUT1: control button 1 or teach input OUT2: control button 2 or teach input
Changeover NO/NC	OUT1: control button 1 or teach input OUT2: control button 2 or teach input

Indicators

Yellow LED	OUT1: object detected
Yellow LED, flashing	teach-in / teaching error / cable short circuit
Green LED	object within the scanning range
Green LED flashing	IO-Link communication

Mechanical data

Housing	all metal - brass, nickel-plated
Weight	110g
Ultrasonic transducer	piezoceramic ⁴⁾
Connection type	M12 connector, 5-pin
Fitting position	any

Environmental data

Ambient temp. (operation/storage)	-25 °C ... +70 °C / -30 °C ... +85 °C
Protective circuit ⁵⁾	1, 2, 3
VDE safety class	III
Degree of protection	IP 67 and IP 68
Standards applied	EN 60947-5-2
Certifications	UL 508, C22.2 No.14-13 ³⁾ ⁶⁾ ⁷⁾

- 1) At 20 °C
- 2) Target: 100mm x 100mm plate
- 3) For UL applications: for use in class 2 circuits according to NEC only
- 4) The ceramic material of the ultrasonic transducer contains lead zirconium titanate (PZT)
- 5) 1=short-circuit and overload protection, 2=polarity reversal protection, 3=wire break and inductive protection
- 6) These proximity switches shall be used with UL Listed Cable assemblies rated 30V, 0.5A min, in the field installation, or equivalent (categories: CYJV/CYJV7 or PVVA/PVVA7);
Use tool for buttons
- 7) Ambient temperature 85 °C. Use same voltage supply for all circuits.

Diagrams

HTU430B-3000...-M12

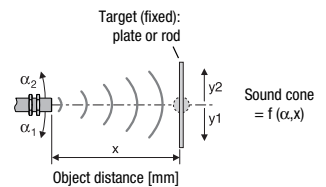
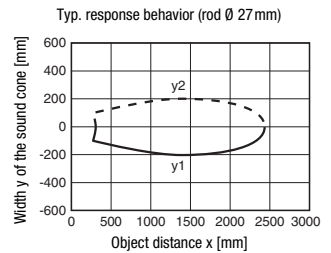
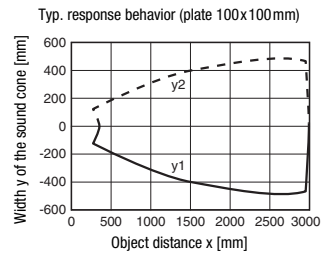

Remarks

Operate in accordance with intended use!

- ⚠ This product is not a safety sensor and is not intended as personnel protection.
- ⚠ The product may only be put into operation by competent persons.
- ⚠ Only use the product in accordance with the intended use.

HTU430B

ADVANCED ultrasonic sensors with 2 switching outputs

Part number code

H	T	U	4	3	0	B	-	3	0	0	0	.	X	3	/	L	T	4	-	M	1	2
---	---	---	---	---	---	---	---	---	---	---	---	---	---	---	---	---	---	---	---	---	---	---

Operating principle

HTU Ultrasonic sensor, scanning principle, with background suppression

DMU Ultrasonic sensor, distance measurement

Series

430B 430B Series, cylindrical M30 construction

Scanning range in mm

3000 300 ... 3000

Equipment (optional)

X "Advanced" design

3 Teach button on the sensor

Pin assignment of connector pin 4 / black cable wire (OUT1)

4 PNP output, NO contact preset

P PNP output, NC contact preset

L IO-Link communication or push-pull (SIO)

Pin assignment of connector pin 2 / white cable wire (Teach-IN)

T Teach input

Pin assignment of connector pin 5 / gray cable wire (OUT2)

4 PNP output, NO contact preset

P PNP output, NC contact preset

V Analog voltage output 0 ... 10V

C Analog current output 4 ... 20mA

X Connection not assigned (n. c. - not connected)

Connection technology

M12 M12 connector, 5-pin

Order guide

The sensors listed here are preferred types; current information at www.leuze.com.

	Designation	Part no.
Scanning range 300 ... 3000mm	HTU430B-3000.X3/LT4-M12	50124273

Device functions and indicators

The sensor has two buttons for adjusting output **OUT1** and output **OUT2**. Alternatively, all adjustments can also be made via **IO-Link**. The **multi funct** teach input can be used to perform the 1-point teach and the changeover of the switching function (NO contact/NC contact).

Switching behavior

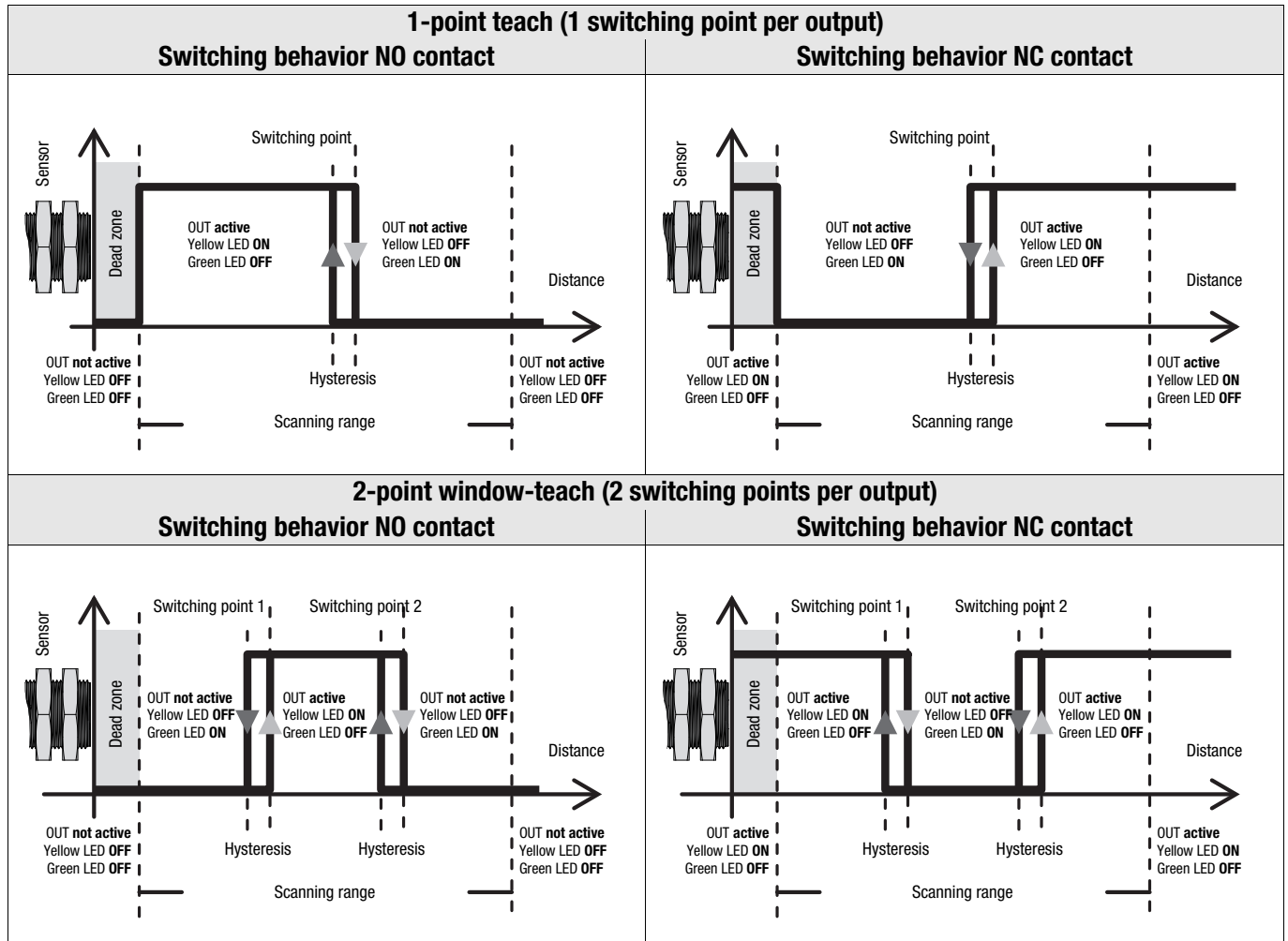

Notice!
The switching behavior is not defined in the dead zone.

Switching behavior with 2-point window-teach as a function of the switching function

Switching function configured as	First taught object distance	Second taught object distance	Output switching behavior
NO contact NC contact	Far	Close	
	Close	Far	



Notice!
In measurement operation, the yellow and green LED only indicate the behavior of output **OUT1**. The behavior of output **OUT2** is not indicated.

The 2-point window-teach can be configured either with the control buttons or via the IO-Link interface. Adjustment via the teach input is not possible.

HTU430B

ADVANCED ultrasonic sensors with 2 switching outputs

Adjustment of the switching points (Teach) using the control buttons

The two switching points of the sensor are both set to 3000mm (static 1-point teach) on delivery.

By means of a simple operating procedure, the switching points for each output can be individually taught to an arbitrary distance within the scanning range with 1-point teach (static) or 2-point window-teach (static).

Moreover, the output function can be switched from NO contact (NO - normally open) to NC contact (NC - normally closed). For the adjustment, an individual control button is permanently assigned to each output (see dimensioned drawing).

1-point teach (static)	2-point window-teach (static) ¹⁾
1. Place object at desired switching distance.	1. First, place object at desired switching distance for switching point 1 .
2. To adjust output OUT1, press button 1, to adjust output OUT2, press button 2 for 2 ... 7s until the yellow LED flashes at 3Hz.	2. To adjust output OUT1, press button 1, to adjust output OUT2, press button 2 for 7 ... 12s until the yellow and green LED flash alternately at 3Hz.
3. Release the button at the end of the teach event. The current object distance has been taught as the new switching point.	3. Release button. The sensor remains in teach mode and the LEDs continue to flash.
4. Error-free teach: LED states and switching behavior according to the diagram shown above. Faulty teach (object may be too close or too far away – please note scanning range): yellow LED flashes at 5Hz until an error-free teach event is performed. The affected output is inactive as long as there is a teach error.	4. Then, place the object at the desired switching distance for switching point 2 . Notice: The minimum distance between the switching points for a scanning range of 3000mm is: 250mm
	5. Briefly press the button again at the end of the teach event. The switching window has been taught.
	6. Error-free teach: LED states and switching behavior according to the diagram shown above. Faulty teach (object may be too close or too far away – please note scanning range): green and yellow LED flash at 8Hz until an error-free teach event is performed.

1) See table "Switching behavior with 2-point window-teach as a function of the switching function"



Notice!

All operating functions are identical for outputs OUT1 and OUT2.

Adjustment of the switching function (NO/NC) using the control buttons

The control buttons can be used to switch the output function from NO contact to NC contact (or vice versa).

To do this, proceed as follows:

Action / Description	Control button	Indicator diode	
		GREEN	YELLOW
Changeover of the switching function: Switching outputs OUT1 and OUT2 are set as NO contact ex works . If the switching function is changed, the corresponding switching output is changed to the opposite state (toggled).	Press the button for the desired switching output for longer than 12s .	Both LEDs flash alternately for a short time at 3Hz. If the yellow LED is then ON , the output functions as an NO contact . If the yellow LED is then OFF , the output functions as an NC contact .	



Notice!

For 2-point window-teach, the switching behavior is dependent on the selected object distances for switching points 1 and 2. See previous page!

Adjusting the switching points (teach) via the teach input

The switching points of the sensor outputs **OUT1/OUT2** are set to 3000mm on delivery.

By means of a simple teach event, the two switching points can be individually taught to an arbitrary distance within the scanning range. The Leuze **PA1/XTSX-M12** teach adapter can be used for this purpose. The adapter can also be used to easily switch the output function from NO contact to NC contact.

1-point teach of output OUT1	1-point teach of output OUT2
1. Place object at desired switching distance.	1. Place object at desired switching distance.
2. For the adjustment of output OUT1, connect input Teach-IN to GND for 2 ... 7s (Leuze teach adapter: position "Teach-GND"). The current state of output OUT1 is frozen during the teach event.	2. For the adjustment of output OUT2, connect input Teach-IN to GND for 7 ... 12s (Leuze teach adapter: position "Teach-GND"). The current state of output OUT2 is frozen during the teach event.
3. The yellow LED flashes at 3Hz and then remains on. The current object distance has been taught as the new switching point.	3. The yellow LED flashes at 3Hz. The current object distance has been taught as the new switching point.
4. Error-free teach: switching behavior according to the diagram shown above. Faulty teach (object may be too close or too far away – please note scanning range): yellow LED flashes at 5Hz until an error-free teach event is performed. The output OUT1 is inactive as long as there is a teach error.	4. Error-free teach: switching behavior according to the diagram shown above. Faulty teach (object may be too close or too far away – please note scanning range): yellow LED flashes at 5Hz until an error-free teach event is performed. The output OUT2 is inactive as long as there is a teach error.



Notice!

Please note that **the switching point is taught when GND is connected and the output function is reversed when U_B is connected. If no sensor action is desired, pin 2 must remain unconnected!**

The 2-point window-teach can be configured either with the control buttons or via the IO-Link interface. Adjustment via the teach input is not possible.

Adjusting the switching function (NC/NO) via the teach input

The switching function of both sensor outputs is set to normally open (NO) on delivery.

If the switching function is changed, the switching output is changed to the opposite state (toggled).

Changeover of the switching function of output OUT1	Changeover of the switching function of output OUT2
1. To change the switching function, connect input Teach-IN to U_B for 2 ... 7s (Leuze teach adapter: position "Teach- U_B "). The current state of output OUT1 remains frozen while the adjustment is performed.	1. To change the switching function, connect input Teach-IN to U_B for 7 ... 12s (Leuze teach adapter: position "Teach- U_B "). The current state of output OUT2 remains frozen while the adjustment is performed.
2. The green and yellow LED flash alternately at 2Hz. The switching function has been reversed. The switching behavior corresponds to the diagram shown above.	2. The green and yellow LED flash alternately at 5Hz. The switching function has been reversed. The switching behavior corresponds to the diagram shown above.

IO-Link interface

The ultrasonic sensor features an IO-Link interface acc. to specification V1.1. and satisfies the Smart Sensor Profile.

As a result, the sensor can easily, quickly and, thus, economically be configured and diagnostic information read out. With a small amount of effort, the sensor can also be integrated in a control.

Overview of the configuration options via IO-Link

Function block	Function	Description
Operating mode	Standard operation	The sensor operates as a scanner with background suppression.
	Multiplex operation	A max. of 10 sensors – 1 master and 9 slaves – can be wired together in a network. To do this, the sensors must be electrically connected with one line. The master generates a timing signal and all networked sensors are activated with time-delay.
	Synchronous operation	A max. of 10 sensors – 1 master and 9 slaves – can be wired together in a network. To do this, the sensors must be electrically connected with one line. The master generates a timing signal and all networked sensors are activated simultaneously.
	Activation operation	The sensor can be activated through an external signal.
	Operation as throughbeam sensor	The sensor can either be configured as a scanner or as a throughbeam sensor. Operation as a throughbeam sensor requires 2 sensors, which are electrically connected through one line.
Switching outputs OUT1 / OUT2	Switching point 1/2	The switching points can be directly entered as distance value in mm.
	Switching output (OUT1/OUT2)	Adjustment as PNP or NPN switching output
	Switching function	Adjustment as NC / NO contact.
	Switching behavior in the case of error	The switching behavior of output OUT1 of the sensor, for objects which are located outside of the scanning range, can be adjusted.
	2-point behavior	If a switching output is to operate with 2 switching points, a choice can be made between 2-point window-teach (factory setting) or 2-point teach (e.g. for simple pump controls with minimum and maximum fill levels).
	Teach switching output OUT1	The switching output OUT1 can be taught via the IO-Link interface.
	Teach lock	Adjustment for locking of control buttons
Temperature	Temperature compensation	Adjustment option for internal (sensor works with the integrated temperature sensor) or external (with a constant application temperature, this can be manually entered. The sensor then compensates the measured values at a fixed rate with this temperature).
	Unit	Adjustment option to °C or °F.
	Temperature value	Entry temperature value in °C or °F (if external temperature compensation is desired).

In addition to the configuration functions, a range of sensor information, such as sensor status, sensor diagnostics as well as the process data, can be called up.

Further information and the device-specific description of the IO-Link interface (**IODD**) can be found on the Internet at www.leuze.com in the **Downloads** area of the respective sensor.

