

Leuze electronic

the sensor people

LES - Line Edge Sensor Light Section Sensors



en 04-2014/09 50116497
We reserve the right to
make technical changes

© 2014

Leuze electronic GmbH + Co. KG

In der Braike 1

D-73277 Owen / Germany

Phone: +49 7021 573-0

Fax: +49 7021 573-199

<http://www.leuze.com>

info@leuze.de

	Figures and tables	8
1	General information	10
1.1	Explanation of symbols	10
1.2	Declaration of conformity	10
2	Safety	11
2.1	Proper use	11
2.3	Competent persons	12
2.4	Disclaimer	13
2.5	Laser safety notices	13
3	Operating principle	16
3.1	Generation of 2D profiles	16
3.2	Limits of light section sensors	17
3.2.1	Occlusion	17
	<i>Possible measure against laser occlusion</i>	18
	<i>Possible measures against receiver occlusion</i>	18
3.2.2	Resolution	19
4	Device description	20
4.1	Overview of light section sensors	20
4.1.1	Mechanical design	20
4.1.2	General performance characteristics	20
4.1.3	Line Edge Sensor - LES	21
	<i>Specific performance characteristics</i>	21
	<i>Typical areas of application</i>	21
4.2	Operating the sensor	22
4.2.1	Connection to PC / process control	22
	<i>Configuration</i>	22
	<i>Measurement operation</i>	22
4.2.2	Activation - laser on/off	22
4.2.3	Triggering - Free Running	23
	<i>PROFIBUS trigger</i>	24
4.2.4	Cascading	24
	<i>Trigger settings</i>	24
	<i>Cascading settings</i>	24
4.3	Measurement functions: LES	25
	<i>Functional principle of object and edge detection with the LES</i>	25
4.3.1	Inspection Task	26
4.3.2	Edge Analysis Window (EAW)	26
	<i>Characteristics of EAWs</i>	26

4.3.3	Definition of EAWs and their analysis results	27
	<i>Edge detection</i>	27
	<i>Relative window positioning</i>	30
	<i>Object detection</i>	31
4.3.4	Application examples for EAWs	32
	<i>Application example: web-edge measurement</i>	32
	<i>Application example: height and width measurement of a cubic object</i>	33
4.4	Analysis Window (AW)	34
5	Installation and mounting	35
5.1	Storage, transportation	35
	<i>Unpacking</i>	35
5.2	Mounting the LES	36
5.2.1	BT 56 mounting device	37
5.2.2	BT 59 mounting device	38
5.3	Device arrangement	39
5.3.1	Selecting a mounting location	39
5.3.2	Aligning the sensor	39
5.4	Attach laser warning sign	40
5.5	Cleaning	40
6	Electrical connection	41
6.1	Safety notices	42
6.2	Shielding and line lengths	43
	<i>Shielding</i>	43
	<i>General shielding information</i>	44
	<i>Connect the ground potential to the light section sensors</i>	44
	<i>Connecting the cable shield in the switch cabinet</i>	45
	<i>Connecting the cable shield to the PLC</i>	45
6.3	Connecting	46
6.3.1	Connection X1 - logic and power	46
	<i>Power supply</i>	46
	<i>Activation input InAct</i>	46
	<i>Trigger input InTrig</i>	46
	<i>Cascading output OutCas</i>	47
	<i>Output "ready" OutReady</i>	47
6.3.2	Connection X2 - Ethernet	47
	<i>Ethernet cable assignment</i>	47
6.3.3	Connection X3 - switching inputs/outputs (LES 36.../VC6)	48
	<i>Switching outputs of connection X3</i>	48
	<i>Switching inputs of connection X3</i>	48
6.3.4	Connection X4 - PROFIBUS DP (LES 36.../PB)	49
6.3.5	Connection X4 - voltage/current output (LES 36.../VC6)	50
	<i>Characteristic curve of the analog output</i>	50
7	Display and control panel	52

7.1	Indicator and operating elements of the	52
7.1.1	LED status displays	52
7.1.2	Control buttons	52
7.1.3	Displays	53
	<i>Alignment aid</i>	53
	<i>Status display</i>	53
	<i>Command mode</i>	54
7.2	Menu description	55
7.2.1	Structure	55
7.2.2	Operation/navigation	58
	<i>Menu navigation</i>	58
	<i>Selecting values or selection parameters for editing</i>	58
	<i>Editing value parameters</i>	58
	<i>Editing selection parameters</i>	58
7.3	Reset to factory settings	59
	<i>Interrupting a reset</i>	59
	<i>Executing a reset</i>	59
8	Commissioning and configuration	60
8.1	Switching on	60
8.2	Establish connection to PC	60
	<i>Setting the default gateway</i>	61
	<i>Setting an alternative IP address on the PC</i>	61
8.3	Commissioning	62
9	LESsoft configuration software	63
9.1	System requirements	63
9.2	Installation	63
9.2.1	Possible error message	69
9.3	Starting LESsoft/Communication tab	70
	<i>PROFIBUS settings (only LES 36/PB and LES 36HI/PB)</i>	72
9.4	Parameter settings/Parameters tab	73
9.4.1	Standard tab - Task Parameters panel	74
	<i>Inspection Task Selection</i>	74
	<i>Operation Mode</i>	74
	<i>Activation</i>	75
	<i>Trigger Output Mode</i>	75
	<i>Light Exposure</i>	75
	<i>Field of View</i>	75
	<i>Apply Settings</i>	75

9.4.2	Standard tab - Analysis Functions panel	76
	<i>Edit Analysis Windows</i>	76
	<i>Using the mouse</i>	77
	<i>Keyboard input</i>	77
	<i>Position type</i>	77
	<i>Relative to Edge</i>	77
	<i>Offset X / Offset Z</i>	77
	<i>Edge Detection Definitions</i>	77
	<i>Analysis Window Definitions</i>	78
	<i>Edit Logical Combinations</i>	79
	<i>Edge State (result of edge and object detection)</i>	79
	<i>Object Point/EAW State (result of edge detection)</i>	80
	<i>Show Edge</i>	80
	<i>X, Width (X), Z, Height (Z)</i>	81
	<i>Profibus Inputs 1, Profibus Inputs 2</i>	81
	<i>Application example 1: web edge measurement</i>	82
	<i>Application example 2: height and width monitoring of cubic objects</i>	83
	<i>Additional object detection with LES sensors</i>	84
	<i>EAW1 ... EAW4, AW05 ... AW08</i>	84
	<i>AW Logic</i>	84
	<i>Analysis Depth</i>	84
	<i>AW Logic Analysis Depth (result of object detection)</i>	85
	<i>Application example 3: width monitoring of cubic objects with object detection (narrow objects are not to be detected)</i>	86
9.4.3	Standard tab - Single Shot Mode panel	88
9.4.4	Standard tab - Global Parameters panel	88
9.4.5	Analog Output tab - configuring the analog output (only LES 36.../VC)	89
	<i>Edge</i>	89
	<i>Output Mode</i>	89
	<i>Data</i>	89
	<i>mm For Min. Val.</i>	90
	<i>mm For Max. Val.</i>	90
9.5	Menu commands	91
9.5.1	Saving parameter settings/File menu	91
9.5.2	Transmitting parameter settings/Configuration menu	91
9.5.3	Zoom and Pan/toolbar	92
9.6	Definition of inspection tasks	92
	<i>Typical procedure</i>	92
10	Integrating the LES in the process control	94
10.1	General information	94
10.2	Protocol structure: Ethernet	94
	<i>Protocol structure</i>	95
	<i>Header</i>	95
10.2.1	Command number	95
10.2.2	Packet number	95
10.2.3	Transaction number	95
10.2.4	Status	96
10.2.5	Encoder High / Low	96
10.2.6	Scan number	97

10.2.7	Type	97
10.2.8	Number of user data	97
10.2.9	Evaluation telegram	97
10.3	Commands	98
10.3.1	Elementary commands	99
10.3.2	Commands in command mode	100
10.3.3	User data in command mode (command parameters)	101
	<i>Set Laser Gate</i>	<i>101</i>
	<i>Set Actual Inspection Task</i>	<i>101</i>
	<i>Get Actual Inspection Task</i>	<i>101</i>
	<i>Set Scan Number</i>	<i>102</i>
	<i>Set Single Inspection Task Parameter (beginning with firmware V01.40!)</i>	<i>102</i>
	<i>Get Single Inspection Task Parameter (beginning with firmware V01.40!)</i>	<i>104</i>
	<i>Set Single User Parameter (beginning with firmware V01.20!)</i>	<i>105</i>
	<i>Set Single User Parameter (beginning with firmware V01.40!)</i>	<i>106</i>
	<i>Get Single User Parameter (beginning with firmware V01.20 !)</i>	<i>106</i>
10.3.4	Commands in measure mode	108
10.4	Working with the protocol	109
	<i>Command without user data</i>	<i>109</i>
	<i>Command with user data</i>	<i>109</i>
10.5	Operation with LxS_Lib.dll	110
	<i>Access</i>	<i>110</i>
10.6	Operation with native C++ DLL	110
10.7	Additional support when integrating sensors	110
11	Integration of the LES 36.../PB in the PROFIBUS	111
11.1	General information	111
	<i>Characteristics of LES 36.../PB</i>	<i>111</i>
11.2	PROFIBUS address assignment	112
	<i>Automatic address assignment</i>	<i>112</i>
	<i>Address assignment with LESsoft</i>	<i>112</i>
	<i>Address assignment with key pad and display</i>	<i>112</i>
11.3	General information about the GSD file	113
11.4	Overview of the GSD files	114
	<i>Output data (from viewing position of control)</i>	<i>114</i>
	<i>Input data (from viewing position of control)</i>	<i>115</i>
11.5	Output data description	116
	<i>PROFIBUS trigger</i>	<i>116</i>
	<i>Activation - Sensor activation</i>	<i>116</i>
	<i>Inspection Tasks - Selection of inspection tasks</i>	<i>116</i>
11.6	Input data description	117

11.6.1	Module M1	117
	Scan number	117
	Sensor info	117
	Sensor state	118
	Logic	118
	Object detection	118
	Measurement value 1 in Edge Analysis Window EAW1	119
11.6.2	Module M2	119
	Measurement value 2 in Edge Analysis Window EAW1 (wEdgeAW1Data2)	119
	Measurement value 1 in Edge Analysis Window EAW2 (wEdgeAW2Data1)	119
	Measurement value 2 in Edge Analysis Window EAW2 (wEdgeAW2Data2)	119
	Measurement value 1 in Edge Analysis Window EAW3 (wEdgeAW3Data1)	119
11.6.3	Module M3	120
	Measurement value 2 in Edge Analysis Window EAW3 (wEdgeAW3Data2)	120
	Measurement value 1 in Edge Analysis Window EAW4 (wEdgeAW4Data1)	120
	Measurement value 2 in Edge Analysis Window EAW4 (wEdgeAW4Data2)	120
12	Diagnostics and troubleshooting	121
12.1	General causes of errors	121
12.2	Interface error	122
12.3	Error messages in display (starting from firmware V01.40)	123
13	Maintenance	125
13.1	General maintenance information	125
	Cleaning	125
13.2	Repairs, servicing	125
13.3	Disassembling, packing, disposing	125
	Repacking	125
14	Specifications	126
14.1	General specifications	126
14.2	Typical measurement range	128
14.3	Dimensioned drawing	129
15	Type overview and accessories	130
15.1	Type overview	130
15.1.1	LPS	130
15.1.2	LRS	130
15.1.3	LES	130
15.2	Accessories	131
15.2.1	Fastening	131
	Mounting devices	131
15.2.2	Accessories - Ready-made cables for voltage supply X1	131
	Contact assignment for connection cable X1	131
	Order codes of cables for voltage supply	132

15.2.3 Accessories for Ethernet interface X2. 132
Ready-made cables with M12 plug/open cable end. 132
Ready-made cables with M12 plug/RJ-45 plug 133
Ready-made cables with M12 plug/M12 plug 133
Connectors 134

15.2.4 Accessories - Ready-made cables for X3 (only LES 36.../VC6). 134
Contact assignment for X3 connection cables 134
Order codes of connection cables for X3 134

15.2.5 Connection accessories / ready-made cables for X4 (only LES 36.../PB). 135
Contact assignment for X4 connection cables 135
Order codes of connection accessories for X4 135
Order codes of PROFIBUS connection cables for X4. 136

15.2.6 Connection accessories / ready-made cables for X4 (only LES 36.../VC6). 137
Contact assignment for X4 connection cables 137
Order codes of connection cables for X4 (only LES 36.../VC6). 137

15.2.7 Configuration memory 137

16 Appendix. 138

16.1 Glossary 138

16.2 Revision History / Feature list 139

16.2.1 Firmware 139

16.2.2 Configuration software 140

Index. 142

Figures and tables

Figure 2.1:	Laser exit openings, Laser warning signs	14
Figure 2.2:	Laser warning and information signs – supplied stick-on labels	15
Figure 3.1:	Light section sensor design	16
Figure 3.2:	Occlusion	17
Figure 3.3:	Typical resolution LES 36...	19
Figure 3.4:	Typical minimum object size LES 36HI...	19
Figure 4.1:	Mechanical design of Leuze light section sensors	20
Figure 4.2:	Activation input signal sequence	22
Figure 4.3:	Trigger input signal sequence	23
Figure 4.4:	Signal sequence for cascading	24
Figure 4.5:	Cascading application example.	24
Figure 4.6:	Edge detection with EAWs	27
Figure 4.7:	Meaning of Sequent Hits for edge detection.	28
Figure 4.8:	Edge detection with EAWs	29
Figure 4.9:	Edge detection with varying object position	30
Figure 4.10:	Application example: web-edge measurement	32
Figure 4.11:	Application example: height and width measurement of a cubic object.	33
Figure 5.1:	Device name plate LES	35
Figure 5.2:	Fastening options	36
Figure 5.3:	Mounting example LES	36
Figure 5.4:	BT 56 mounting device	37
Figure 5.5:	BT 59 mounting device	38
Figure 5.6:	Alignment to the measuring plane	40
Figure 6.1:	Location of the electrical connections.	41
Figure 6.2:	Connections of the LES	41
Table 6.1:	Interface version of X3 and X4.	42
Table 6.2:	Line lengths and shielding	43
Figure 6.3:	Connecting the ground potential to the light section sensor.	44
Figure 6.4:	Connecting the cable shield in the switch cabinet	45
Figure 6.5:	Connecting the cable shield to the PLC	45
Table 6.3:	Pin assignment X1	46
Figure 6.6:	Internal wiring at X1	46
Table 6.4:	Pin assignment X2	47
Figure 6.7:	HOST / BUS IN cable assignments on RJ-45	47
Table 6.5:	Pin assignment X3	48
Table 6.6:	Pin assignment X4 for LES 36.../PB	49
Table 6.7:	Pin assignment X4 for LES 36.../VC6	50
Figure 6.8:	Response of analog output LES	51
Figure 7.1:	Indicator and operating elements of the LES	52
Table 7.1:	LED function indicator	52
Table 7.2:	Menu structure.	55
Table 8.1:	Address allocation in the Ethernet.	60
Figure 9.1:	Initial screen LESsoft	70
Figure 9.2:	PROFIBUS settings	72
Figure 9.3:	Parameter settings LESsoft	73
Figure 9.4:	Edit Analysis Windows.	76
Figure 9.5:	'Edge Analysis Window Combination Tables' window	79

Figure 9.6:	Display of the edge positions (green and blue) in the 2D display.	80
Figure 9.7:	Application example 1: web edge measurement	82
Figure 9.8:	Application example 2: height and width monitoring of cubic objects.	83
Figure 9.9:	Application example 3.1: width monitoring of cubic objects with object detection	86
Figure 9.10:	Application example 3.2: width monitoring of cubic objects with object detection	87
Figure 9.11:	Parameter settings in LRSsoft	89
Figure 9.12:	Zoom function.	92
Table 10.1:	Connection commands.	99
Table 10.2:	Command mode control commands	99
Table 10.3:	Sensor control commands	100
Table 10.4:	Commands in measure mode.	108
Figure 11.1:	PROFIBUS address assignment with LESsoft	112
Table 11.1:	PROFIBUS - Overview of output data (from viewing position of control).	114
Table 11.2:	Input data byte uSensorInfo	117
Table 11.3:	Input data byte uSensorState	118
Table 11.4:	Input data byte uResultEdge/Logic	118
Table 11.5:	Input data byte uResultAWs	118
Table 11.6:	Input data bytes wEdgeAW1Data1 (high and low byte)	119
Table 12.1:	General causes of errors.	121
Table 12.2:	Interface error	122
Table 12.3:	Error messages in display.	123
Figure 14.1:	Typical measurement range LES 36.	128
Figure 14.2:	Typical measurement range LES 36HI	128
Figure 14.3:	Dimensioned drawing LES	129
Table 15.1:	Type overview LPS	130
Table 15.2:	Type overview LRS	130
Table 15.3:	Type overview LES	130
Table 15.4:	Mounting devices for the LES.	131
Table 15.5:	K-D M12A-8P... cable assignments.	131
Table 15.6:	X1 cables for the LES	132
Table 15.7:	Pin assignments KB ET-...-SA	132
Table 15.8:	Ethernet connection cables featuring M12 plug/open cable end	132
Table 15.9:	Pin assignments KB ET-...-SA-RJ45	133
Table 15.10:	Ethernet connection cables M12 connector/RJ-45	133
Table 15.11:	Pin assignments KB ET-...-SSA	133
Table 15.12:	Ethernet connection cables featuring M12 plug/M12 plug	133
Table 15.13:	Connectors for the LES	134
Table 15.14:	Pin assignments KB M12/8-...-SA.	134
Table 15.15:	X3 cables for the LES 36.../VC6	134
Table 15.16:	Pin assignment X4 (PROFIBUS)	135
Figure 15.1:	Cable structure for PROFIBUS connection cables.	135
Table 15.17:	PROFIBUS connection accessories for the LES 36.../PB	135
Table 15.18:	PROFIBUS cables for LES 36.../PB	136
Table 15.19:	Pin assignment X4	137
Table 15.20:	Connection cables for LES 36/VC6, LES 36HI/VC6	137
Table 15.21:	Configuration memory for LxS 36.	137
Table 16.1:	Revision History - Firmware	139
Table 16.2:	Revision History - Configuration software	140

1 General information

1.1 Explanation of symbols

The symbols used in this technical description are explained below.



Attention!

This symbol precedes text messages which must strictly be observed. Failure to comply with this information results in injuries to personnel or damage to the equipment.



Attention Laser!

This symbol warns of possible danger caused by hazardous laser radiation.

The light section sensors of the LES series use a class 2M laser: Viewing the laser output with certain optical instruments, e.g. magnifying glasses, microscopes or binoculars, may result in eye damage.



Notice!

This symbol indicates text passages containing important information.

1.2 Declaration of conformity

The laser light section sensors of the 36 and 36HI series have been developed and manufactured in accordance with the applicable European standards and directives. They comply with the safety standards UL508 and CSA C22.2 No. 14 (Industrial Control Equipment).



Notice!

The CE Declaration of Conformity for these devices can be requested from the manufacturer.

The manufacturer of the product, Leuze electronic GmbH & Co. KG in D-73277 Owen, possesses a certified quality assurance system in accordance with ISO 9001.



2 Safety

This sensor was developed, manufactured and tested in line with the applicable safety standards. It corresponds to the state of the art.

2.1 Proper use

The light section sensors of the LES series are laser distance sensors for presence detection of dimensions of objects using their edges.

Areas of application

The LES series light section sensors are especially designed for the following areas of application:

- Edge and height measurement of web material products and paper rolls
- Width and height measurement of cartons
- Edge and height measurement of stackable materials (e.g. chipboards)
- Complex object detection with window tracking



CAUTION

Observe intended use!

⚠ Only operate the device in accordance with its intended use. The protection of personnel and the device cannot be guaranteed if the device is operated in a manner not complying with its intended use.

Leuze electronic GmbH + Co. KG is not liable for damages caused by improper use.

⚠ Read the technical description before commissioning the device. Knowledge of this technical description is an element of proper use.

NOTE

Comply with conditions and regulations!

⚠ Observe the locally applicable legal regulations and the rules of the employer's liability insurance association.

OPERATION NOTICE IN ACCORDANCE WITH UL CERTIFICATION:

CAUTION – Use of controls or adjustments or performance of procedures other than specified herein may result in hazardous light exposure.



Attention

For UL applications, use is only permitted in class 2 circuits in accordance with the NEC (National Electric Code).

2.2 Foreseeable misuse

Any use other than that defined under the "Approved purpose" or which goes beyond that use is considered improper use.

In particular, use of the device is not permitted in the following cases:

- Rooms with explosive atmospheres
- in circuits which are relevant to safety
- Operation for medical purposes

NOTE

Do not modify or otherwise interfere with the device.

- ↳ Do not carry out modifications or otherwise interfere with the device. The device must not be tampered with and must not be changed in any way. The device must not be opened. There are no user-serviceable parts inside. Repairs must only be performed by Leuze electronic GmbH + Co. KG.

2.3 Competent persons

Connection, mounting, commissioning and adjustment of the device must only be carried out by competent persons.

Prerequisites for competent persons:

- They have a suitable technical education.
- They are familiar with the rules and regulations for occupational safety and safety at work.
- They are familiar with the technical description of the device.
- They have been instructed by the responsible person on the mounting and operation of the device.

Certified electricians

Electrical work must be carried out by a certified electrician.

Due to their technical training, knowledge and experience as well as their familiarity with relevant standards and regulations, certified electricians are able to perform work on electrical systems and independently detect possible hazards.


In Germany, certified electricians must fulfill the requirements of accident-prevention regulations BGV A3 (e.g. electrician foreman). In other countries, there are respective regulations that must be observed.

2.4 Disclaimer

Leuze electronic GmbH + Co. KG is not liable in the following cases:

- The device is not being used properly.
- Reasonably foreseeable misuse is not taken into account.
- Mounting and electrical connection are not properly performed.
- Changes (e.g., constructional) are made to the device.

2.5 Laser safety notices



ATTENTION, LASER RADIATION – LASER CLASS 2M

Never look directly into the beam or point the beam in the direction of telescope users!

The device fulfills the EN 60825-1:2008-05 (IEC 60825-1:2007) safety regulations for a product in **laser class 2M** as well as the U.S. 21 CFR 1040.10 regulations with deviations corresponding to "Laser Notice No. 50" from June 24th, 2007.

- ⚠ Never look directly into the laser beam or in the direction of reflecting laser beams!
If you look into the beam path over a longer time period, there is a risk of injury to the retina.
- ⚠ Do not point the laser beam of the device at persons!
- ⚠ Intercept the laser beam with an opaque, non-reflective object if the laser beam is accidentally directed towards a person.
- ⚠ When mounting and aligning the device, avoid reflections of the laser beam off reflective surfaces!
- ⚠ **CAUTION!** The use of operating or adjusting devices other than those specified here or carrying out of differing procedures may lead to dangerous exposure to radiation. The use of optical instruments or devices (e.g., magnifying glasses, binoculars) with the product will increase eye hazard.
- ⚠ Adhere to the applicable legal and local regulations regarding protection from laser beams acc. to EN 60825 (IEC 60825) in its latest version.
- ⚠ The device must not be tampered with and must not be changed in any way. There are no user-serviceable parts inside the device. Repairs must only be performed by Leuze electronic GmbH + Co. KG.

NOTE**Affix laser information and warning signs!**

Laser warning and laser information signs are affixed to the device (see figure 2.1):

Also included with the device are self-adhesive laser warning and laser information signs (stick-on labels) in multiple languages (see figure 2.2).

- ↙ Affix the laser information sheet with the language appropriate for the place of use to the device.

When using the device in the US, use the stick-on label with the "Complies with 21 CFR 1040.10" notice.

- ↙ Affix the laser information and warning signs near the device if no signs are attached to the device (e.g. because the device is too small) or if the attached laser information and warning signs are concealed due to the installation position.

Affix the laser information and warning signs so that they are legible without exposing the reader to the laser radiation of the device or other optical radiation.

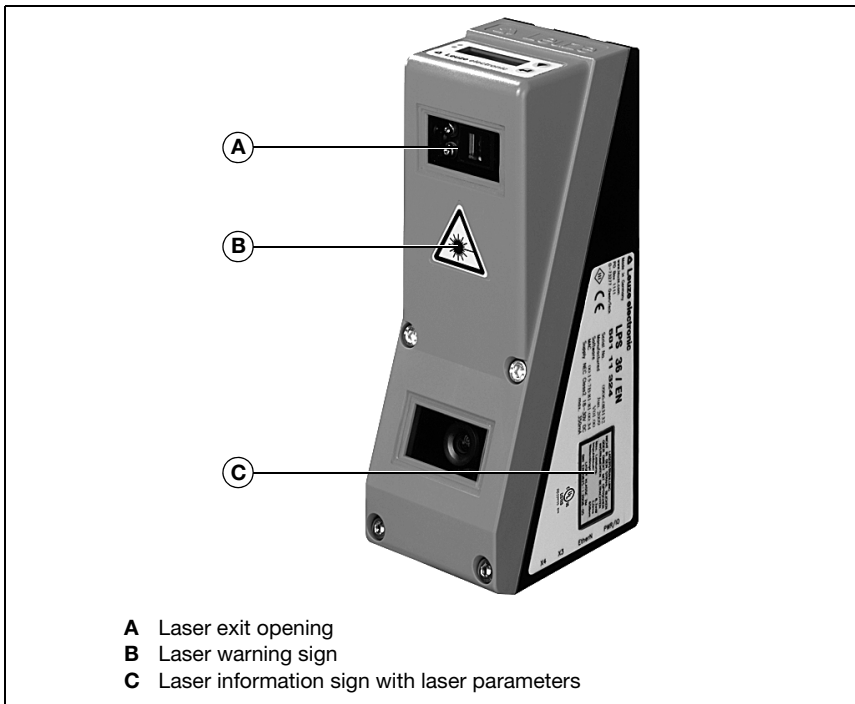


Figure 2.1: Laser exit openings, Laser warning signs

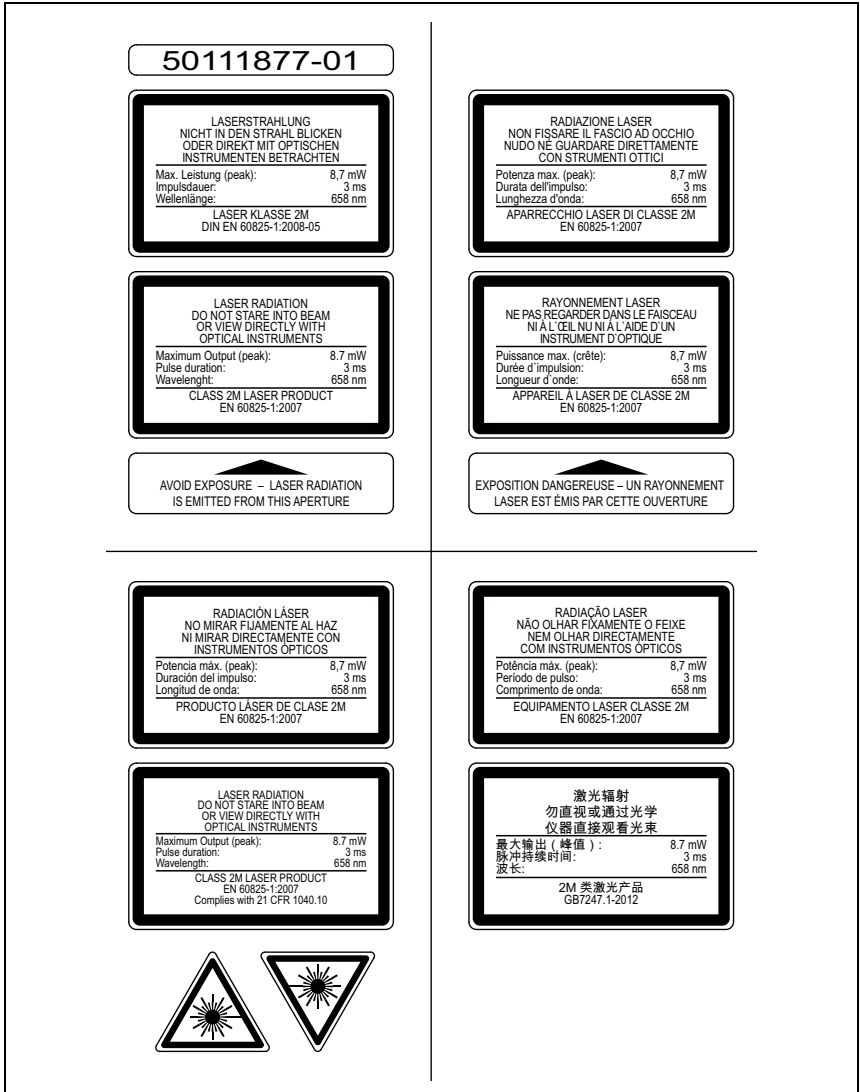


Figure 2.2: Laser warning and information signs – supplied stick-on labels

3 Operating principle

3.1 Generation of 2D profiles

Light section sensors work according to the triangulation principle. Using transmission optics a laser beam is expanded to a line and aimed at an object. The light remitted by the object is received by a camera, which consists of receiver optics and the CMOS area detector.

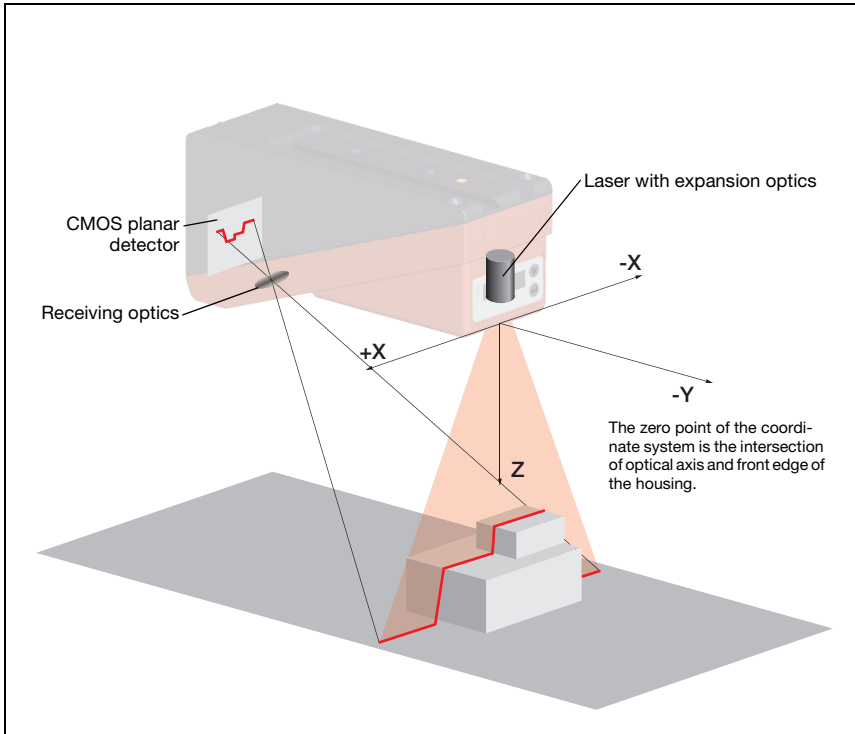


Figure 3.1: Light section sensor design

Depending on the distance of the object the laser line is projected to a different position on the CMOS planar detector as shown in figure 3.1. By means of this position the distance of the object can be calculated.

3.2 Limits of light section sensors

3.2.1 Occlusion

The detection of high and wide objects from just one point poses the particular problem that depending on the object contour, parts of the object may be obscured by others. This effect is called occlusion.

The figure 3.2 illustrates the problem:

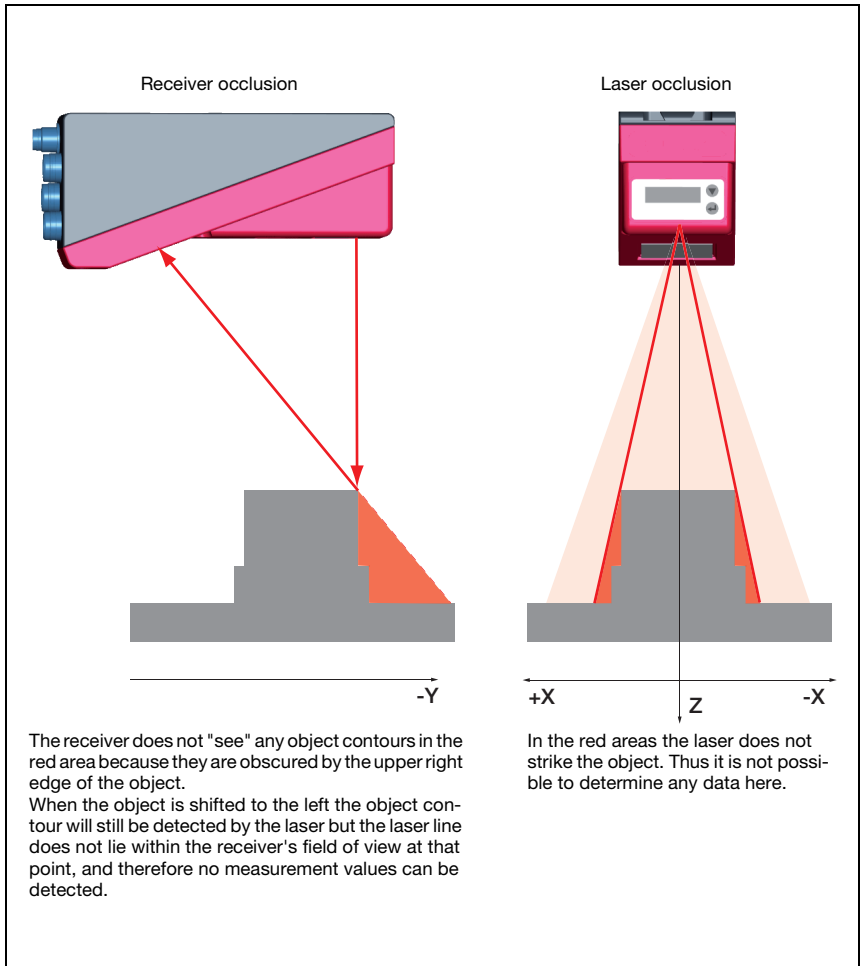


Figure 3.2: Occlusion

Possible measure against laser occlusion

- Using multiple light section sensors with rotated viewing direction. In the application example on the right you can clearly see that the fields of vision of the three sensors complement each other and merge. The first of the sensors is operated as a master, the two others are cascaded (see "Cascading" on page 24). This reliably prevents mutual interference of the sensors.

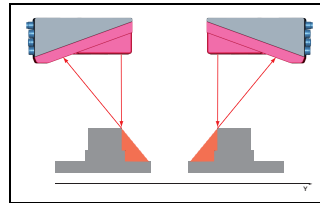


Possible measures against receiver occlusion

- Alignment of the measurement objects so that all profile data to be measured can be seen by the receiver.

Or:

- Installing a second sensor featuring a viewing direction rotated by 180° about the z-axis so that the objects can be viewed from 2 sides. In the example to the right, the left sensor detects the profile data on the left side of the product, and the right sensor the profile data on the right side. In this situation the second sensor is then cascaded. See "Cascading" on page 24.



3.2.2 Resolution

In this context resolution means the smallest possible change in distance of the measurement object, which causes a unique change of the output signal. Resolution is higher in the short range than in the distant range. Small objects can be recognized better in the short range.

The length of the laser line in the X-direction is dependent on the distance Z of the measurement object from the sensor. Always the same number of measurement points is measured. From this it follows that the resolution in X-direction decreases with increasing distance in Z-direction.

The following illustration shows this relation:

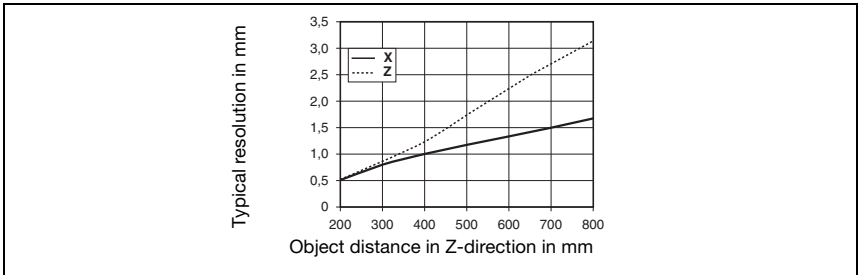


Figure 3.3: Typical resolution LES 36...

The output resolution of the measurement values on the process interface is 1/10mm with Standard-Connect, 1/100mm with HI-Connect (only with LES 36HI/VC6).

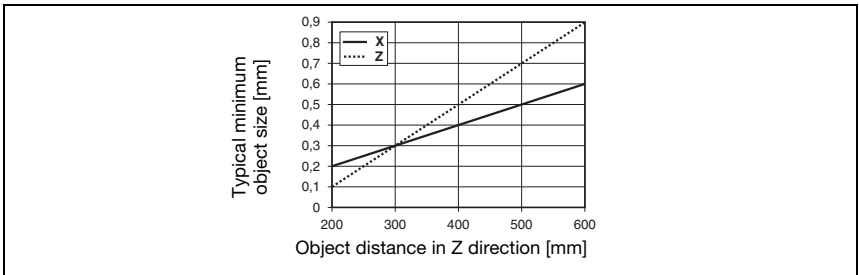


Figure 3.4: Typical minimum object size LES 36HI...

4 Device description

4.1 Overview of light section sensors

4.1.1 Mechanical design

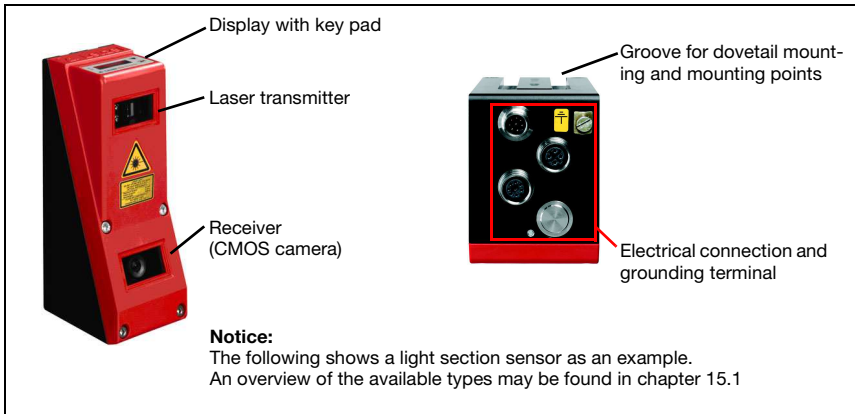


Figure 4.1: Mechanical design of Leuze light section sensors

4.1.2 General performance characteristics

- Light section sensor for width, height and position detection
- Measurement time/response time: 10ms
- Measurement range/detection area: 200 ... 800mm
- Measurement range/detection area: LES 36...: 200 to 800mm, LES 36HI...: up to 600mm
- Length of laser line: max. 600mm
- Length of the laser line: LES 36...: max. 600mm, LES 36HI...: max. 140mm
- Configuration and transmission of process data via Fast Ethernet
- OLED display with key pad
- Measurement value display in mm on OLED display as an alignment aid
- Up to 16 inspection tasks
- Compact construction
- Robust design and easy operation
- Activation input, trigger input, cascading output

4.1.3 Line Edge Sensor - LES

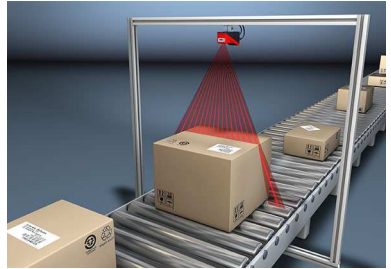
Line edge sensors determine the positions and dimensions of objects via their edges. The sensor determines the edge positions in mm and, from those, calculates the object width and height. These data are transferred to the process control. One sensor can be used to simultaneously detect up to four value pairs of edges.

Specific performance characteristics

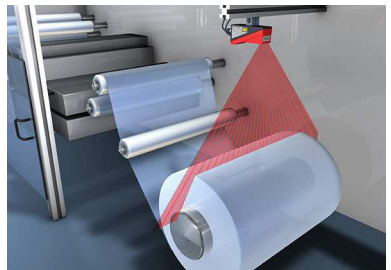
- Configuration software LESsoft
- Data calculation and processing directly inside the sensor
- Integrated PROFIBUS interface or analog output
- Up to four edge analysis windows with two edge-value pairs each
- Up to 8 analysis windows with logic operation option
- Detailed information on measurement function, analysis windows, detection functions and sensor state via Ethernet and PROFIBUS

Typical areas of application

- Edge and height measurement of web material products and paper rolls
- Width and height measurement of cartons
- Edge and height measurement of stackable materials (e.g. chipboards)



Width and height measurement of cartons



Determining width and diameter of roll goods

4.2 Operating the sensor

4.2.1 Connection to PC / process control

Configuration

For commissioning the light section sensors are connected to a PC via the Ethernet interface (see "Connection X2 - Ethernet" on page 47) and are then set using the configuration software supplied LESsoft.

Measurement operation

In measurement operation, the LES 36.../VC6 is connected to the process control via its analog output, the LES 36.../PB is connected to the process control via PROFIBUS. Alternatively, the LES can be operated via the Ethernet interface on X2, see chapter 10 "Integrating the LES in the process control (Ethernet)". Additional sensor information is then available.

4.2.2 Activation - laser on/off

The laser and the data transmission can selectively be switched on and off via the activation input **InAct** (pin 2 at X1) or via the 'Ethernet Trigger' command. Thus possible glares due to laser radiation can be prevented during time periods when no measurements are performed.



Notice!

The sensor is delivered ex works with the Activation Input Disregard setting. The possible activation sources (activation input and Ethernet activation) are ignored - the measurement function of the sensor is enabled.

The activation function can be switched on via the configuration software. To do this, the Activation Input parameter must be set to Regard. The sensor then only measures if one of the activation sources is activated. If the sensor is waiting for activation, it displays !Act in the display.

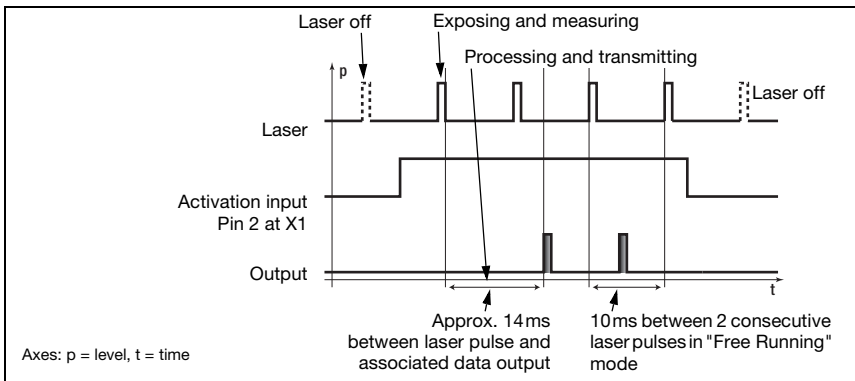


Figure 4.2: Activation input signal sequence

The figure 4.2 shows the effect of the activation on laser and measurement value output in "Free Running" mode.

4.2.3 Triggering - Free Running

The light section sensors can measure in two modes:

- In "Free Running" operation the light section sensor determines measurement results with a frequency of 100Hz and outputs these continuously via the interface X2.
- Alternatively, single measurements can also be carried out. For this purpose, the light section sensor requires a trigger signal at the trigger input (pin 5 on X1), a PROFIBUS trigger or the Ethernet Trigger command in measure mode (see chapter 10.3.4 "Commands in measure mode" on page 108).

When triggering via pin 5 at X1, note:

- Triggering occurs on the rising edge.
- The trigger pulse must be at least 100µs long.
- Before the next trigger, the trigger cable must be on low-level for at least 1 ms.
- Activation must occur at least 100µs before the trigger edge.
- The shortest possible time interval between two successive trigger edges is 10ms.



Notice!

Ex works, the LES is set to Free Running (shown on display: fRun). In order for it to respond to signals on the trigger input, the operating mode must be set via the LESsoft configuration software to Input Triggered (shown on display: Trig).

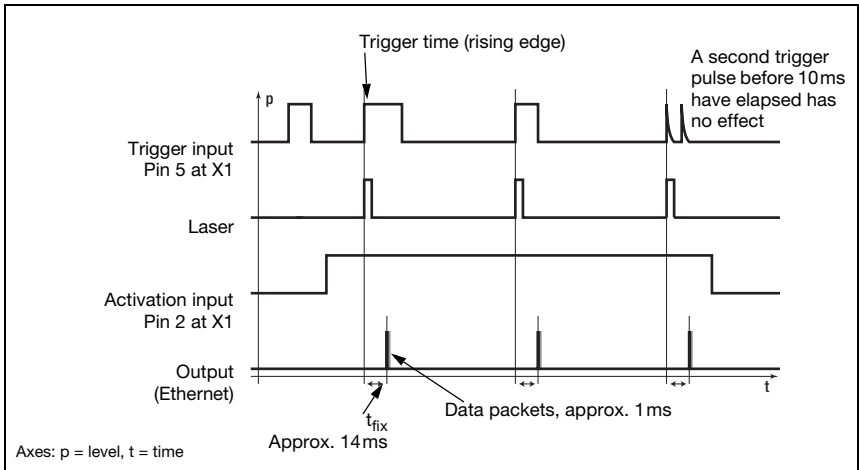


Figure 4.3: Trigger input signal sequence

PROFIBUS trigger

So that a measurement can be triggered on each PROFIBUS cycle, the PROFIBUS trigger of the LES responds to a change of master output byte **uTrigger**. The control only needs to increment the trigger value in order to initiate a new measurement.

The maximum trigger frequency is 100Hz. If triggering occurs during a measurement, the trigger signal is ignored, as is the case in the **Free Running** operating mode.

4.2.4 Cascading

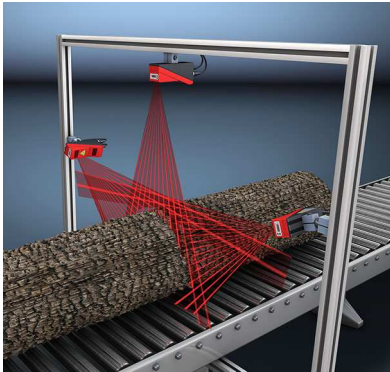


Figure 4.5: Cascading application example

If several light section sensors are operated, there is the risk of mutual interference if the reflected laser beam of one sensor can be received by the receiver of another sensor at the time of reading.

This can easily be seen in figure 4.5. Here three light section sensors are used to determine the log thickness reliably from all sides.

To prevent mutual interference the light section sensors can be operated cascaded: the exposure by the second sensor will be initiated following completion of the exposure by the first sensor. To achieve this, the cascading output of the first sensor must be connected to the trigger input of the second sensor. Up to 6 sensors can thus be operated cascaded.

Trigger settings

Sensor 1, or the master, can be operated in this case both triggered as well as continuously. All other sensors must be operated triggered.

Cascading settings

For all sensors except the last slave, the cascading output must be enabled via configuration software: Cascading Output: Enable.

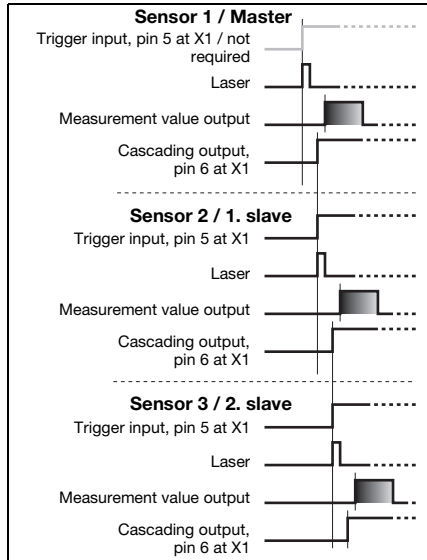


Figure 4.4: Signal sequence for cascading

**Notice!**

In PROFIBUS operation, cascading only functions as described above via the InTrig and Out-Cas inputs/outputs at X1. In this case, the maximum detection rate of 100Hz is achieved. Make certain, however, that the input data of the PROFIBUS light section sensors are still transmitted in the same bus cycle; monitor the scan numbers if necessary.

Alternatively, light section sensors with PROFIBUS can be selectively triggered in sequence. Master output 'uTrigger' of the sensor to be triggered is incremented on each PLC cycle; the master outputs of the other sensors do not change. The maximum detection rate of 100Hz is not achieved with this process.

If multiple sensors are triggered in a PROFIBUS cycle, mutual interference may occur between the sensors if they are in the same visual field and the time between updating byte 'uTrigger' is shorter than the maximum exposure time (Exposure Time) of 1.3ms.

4.3 Measurement functions: LES

With the LES, you can reliably detect objects and measure their edge position, height and width. Adaptation of the LES to an application is performed using the LESsoft configuration software. All settings for the application are made there and stored in up to 16 inspection tasks.

Functional principle of object and edge detection with the LES

The distance profile of the application is determined along the laser line in 376 measurement points. Rectangular analysis windows, used for object and edge detection, can be defined in the measurement range.

Object detection

The number of measurement points is counted in the analysis window (Analysis Window = AW or Edge Analysis Window = EAW) and compared with two adjustable limits. From this, the logical state **ok** or **not ok** of the analysis window is determined. For unique object detection, it may be necessary to combine multiple analysis windows. For this purpose, the LES offers the AND combination and inversion of multiple analysis windows. The logic combinations ensure the detection of problematic objects.

Edge detection:

Windows for edge detection are called Edge Analysis Windows (EAW). In an EAW, object detection can be performed as described above. Also determined in an EAW are the X and Z coordinates of the first ("left-most") and the last ("right-most") measurement point. By appropriately selecting the size and position of the EAWs, it is possible to determine coordinates of edge positions. From these, the width and height of an object are calculated. For robust edge detection, the "Sequent Hits" parameter was introduced. The minimum number of measurement points set there must occur in succession in the EAW to detect a valid edge. Outliers or missing measurement points reset the counter.

4.3.1 Inspection Task

The LES supports up to 16 individual inspection tasks. Grouped together in an inspection task are all parameter settings relevant for an application:

- Operation Mode (Free Running, Input Triggered)
- Activation Input (switch laser on and off)
- Cascading Output
- Light Exposure (exposure duration of the laser)
- Field of View (sensor detection range)
- Edit Analysis Windows (size and position of four AWs and four EAWs, object detection and edge detection parameters)
- Edit Logical Combinations (logic combination of AWs and EAWs, definition of the values that are available via the Profibus)
- Analog Output (analog output definitions)

The selection of the inspection tasks is carried out:

- via the switching inputs of connection X3 (inspection tasks 0-7 only)
- via PROFIBUS
- via LESSoft (on a PC connected via X2)
- via Ethernet (on a process control connected via X2)
- via the control panel of the sensor beginning with firmware V01.40.

4.3.2 Edge Analysis Window (EAW)

EAWs are used for edge detection; they can also be used for object detection. EAWs are configured in the LESSoft configuration software (see chapter 9.4 "Parameter settings/Parameters tab", figure 9.3). Here, position and size of each EAW are defined. To ensure stable measurement of edge positions, it is also possible to

- check the edge quality (Sequent Hits, see below),
- count the number of measurement points to be detected in the EAW (a quasi minimum object size).

An evaluation is carried out only within the active EAWs. Areas outside of the measurement range and field of view are ignored.

Characteristics of EAWs

- EAWs are rectangular and may overlap freely.
- The coordinates of the left-most measurement point ("leftmost" LX, LZ) and right-most measurement point ("rightmost" RX, RZ) are determined in each EAW.
- EAWs usually have an absolute position. If the object position varies, an EAW can also be positioned relative to a found edge position in the previous EAW and thus tracked.

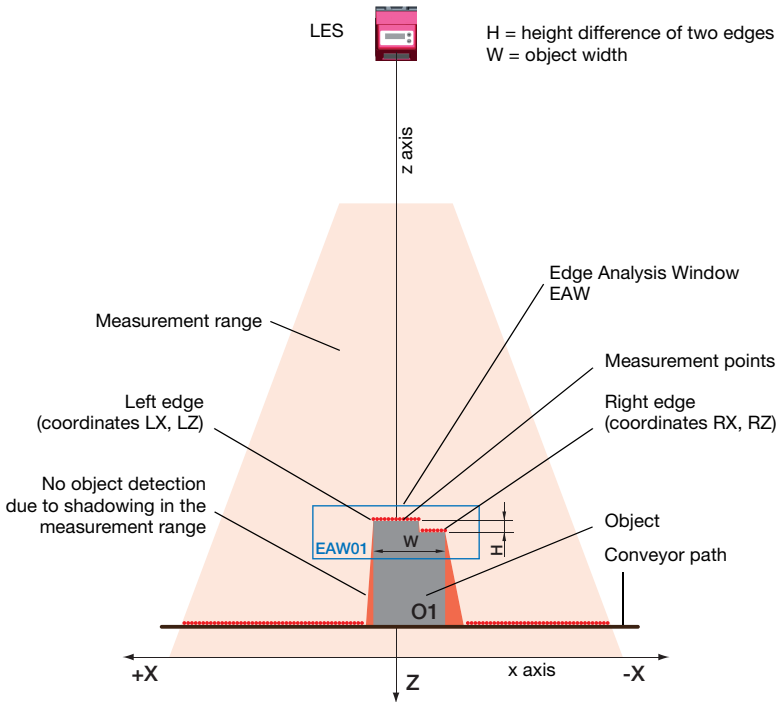


Figure 4.6: Edge detection with EAWs

4.3.3 Definition of EAWs and their analysis results

Edge detection

Edge detection with the LES is possible if the following prerequisites are met:

There are enough successive measurement points in the EAW at both the right and the left edge. This serves the plausibility of the edge detection.

Edges are only detected if the number of successive measurement points is greater than or equal to the defined minimum number of measurement points (Sequent Hits). If there are not enough successive measurement points in an EAW, no edge detection and no object measurement is possible within this EAW.

Configuration of the edge detection in EAWs is performed with **LESsoft** (Edit Analysis Windows -> Edge Detection Definitions).



Notice!

If there are not enough successive measurement points on the edges of an EAW, the found edge positions are shifted away from the edges of the EAW (see figure 4.7, different right edge position with different parameters for Sequent Hits).

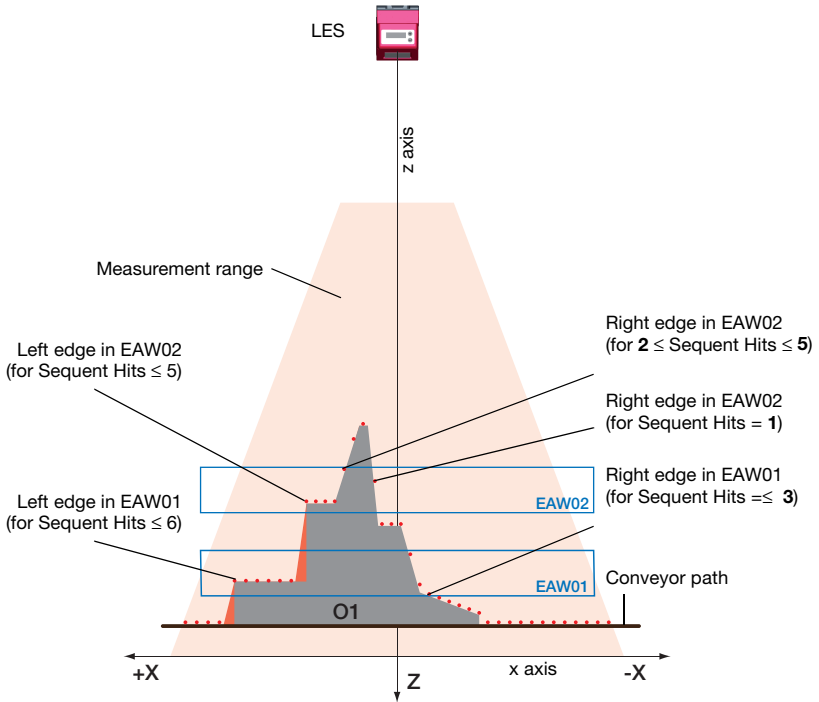


Figure 4.7: Meaning of Sequent Hits for edge detection

For each EAW, up to two measurement values can be output (configuration with **LESsoft**: Edit Logical Combinations):

- Edge positions: LX, LZ, RX, RZ (LX = left edge, X-coordinate, LZ = left edge, Z-coordinate, RX = right edge, X-coordinate, RZ = right edge, Z-coordinate).
- Width of objects: W (calculated from the distance of RX and LX in the X direction).
- Height difference of left and right edge: H (calculated from the distance of RZ and LZ in the Z-direction).

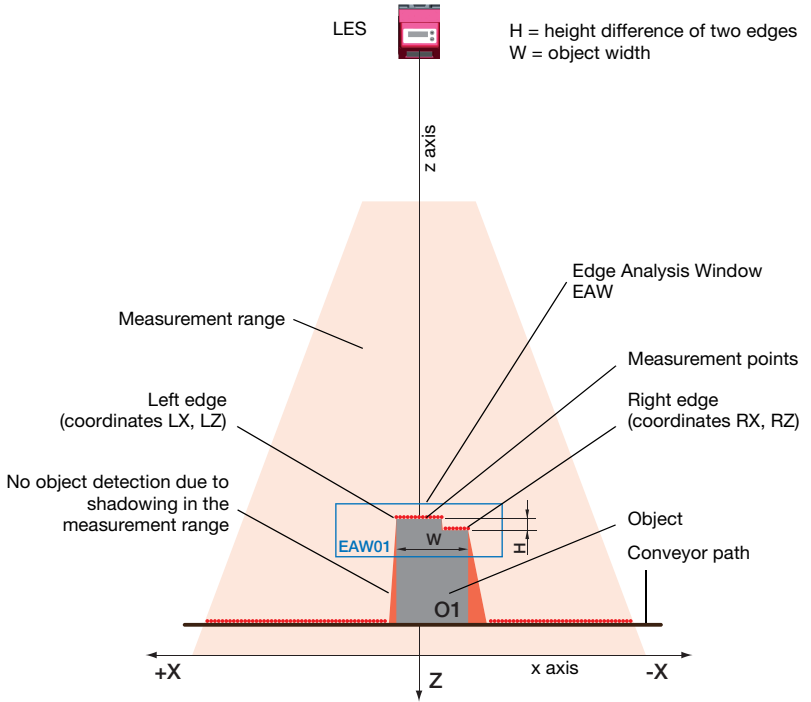


Figure 4.8: Edge detection with EAWs

Relative window positioning

If the position tolerance of the measurement object exceeds the possible size of the analysis window, it is possible to move the EAW relative to the position of the measurement object.

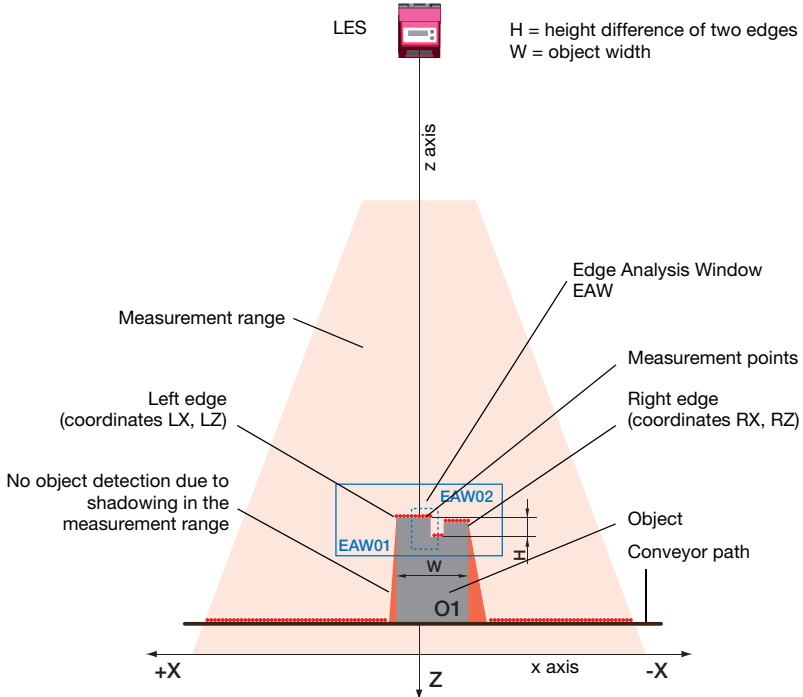


Figure 4.9: Edge detection with varying object position

For precise definition of the reference edge, the measurement object is placed within EAW01 and acquisition of measurement data is stopped (pause button) as soon as the desired reference edge has been found.

In the now static measurement profile, a further analysis window (e.g. EAW02) can be positioned relative to the right or left object edge found in EAW01. This window now tracks all position changes of the object edge to be measured, both in the X-direction and Z-direction.



Notice!

The evaluation functions are defined using LESsoft (see chapter 9.4).

Object detection

In addition to edge detection, functions for object detection are also available in the LES. By way of the optional configuration of the detection functions, even problematic objects can be reliably measured.

- During object detection, the number of measurement points in an EAW/AW are ascertained and compared with two adjustable limits. From this, the logical object detection state **ok** or **not ok** of the EAW is determined. Configuration of the object detection in EAWs/AWs is performed with **LESsoft** (Edit Analysis Windows -> Analysis Window Definitions).

For unique object detection, it may be necessary to combine EAWs or AWs. For this purpose, the LES offers the AND combination and inversion of multiple analysis windows. The configuration of applications with additional object detection with logic combinations is performed with LESsoft (Edit Logical Combinations -> AW Logic panel).

The result of combinations can be output via PROFIBUS or Ethernet. Detailed evaluation results such as, e.g., the status of all EAWs/AWs, the number of measurement points within the EAW/AW and the state of the complete object detection are transmitted via Ethernet. For more information please refer to chapter 10 and chapter 11.



Notice!

An object detection is carried out only within the active EAWs. Areas outside of the measurement range and field of view are likewise not evaluated. An object is detected if the number of measurement values in the EAW reaches or exceeds an arbitrarily defined minimum value.



Notice!

The number of hit points does not necessarily correspond with the object size, since the number of hit points is dependent on distance z . At near distance to the sensor (e.g., 300 mm), an object expanded in the X direction has nearly twice as many hit points as it does at a far distance (e.g., 600mm). If the object distance is the same, the number of hit points remains nearly constant.

4.3.4 Application examples for EAWs

Application example: web-edge measurement

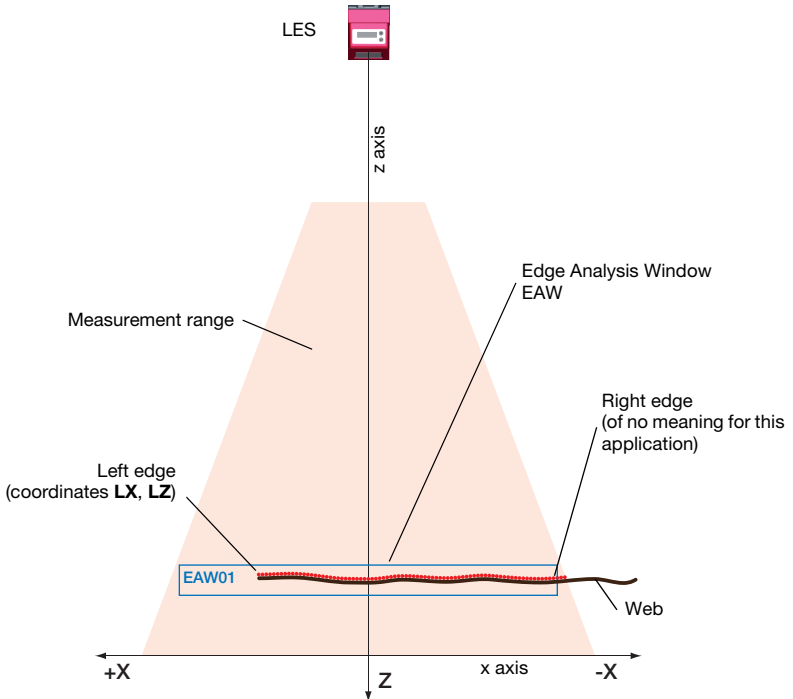


Figure 4.10: Application example: web-edge measurement

In the example shown above, the edge position of web material is to be determined. Analysis is performed in Edge Analysis Window EAW01. The edge coordinates for edge LX, LZ are determined in EAW01.

Application example: height and width measurement of a cubic object

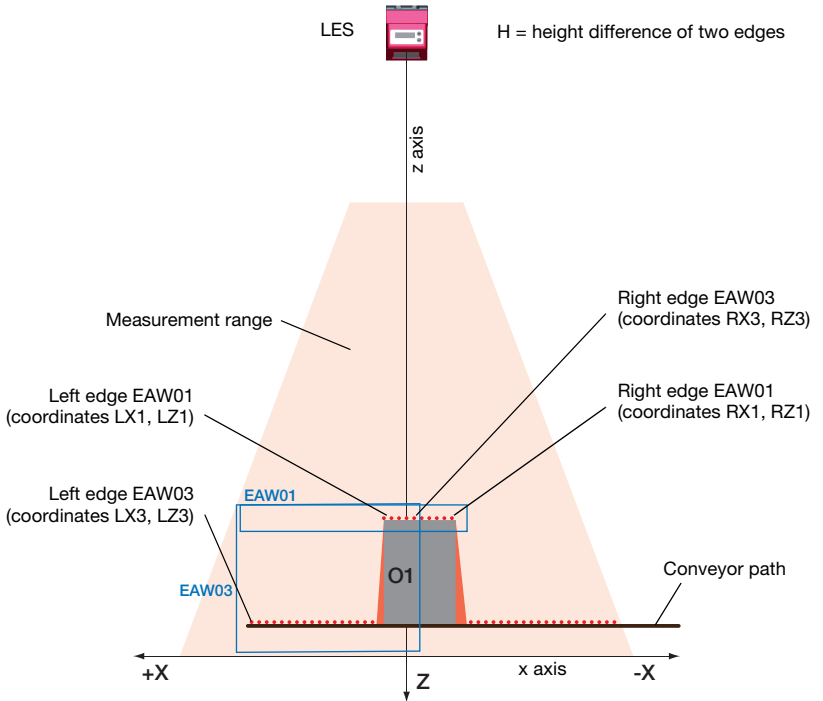


Figure 4.11: Application example: height and width measurement of a cubic object

In the application example shown above, the height and width of a cubic object **O1** is to be determined. The object is on a transport system. The width is measured in edge analysis window **EAW01**; the height is measured in **EAW03**. The following measurement values are obtained:

- in **EAW01**: **Object Width** $W = LX1 - RX1$
- in **EAW03**: **Object Height** $H = RZ3 - LZ3$

4.4 Analysis Window (AW)

In addition to the EAWs, four AWs can be configured with the LES. In AWs, only object detection is possible.

During object detection, the number of measurement points in an AW is determined and compared with two adjustable limits. From this, the logical object detection state **ok** or **not ok** of the AW is determined. If there are not enough measurement points in the AW, the object detection state is **not ok**. Configuration of the object detection in EAWs/AWs is performed with **LESsoft** (Edit Analysis Windows -> Analysis Window Definitions). The position and size of the AW are configured here for each AW.

For unique object detection, it may be necessary to combine AWs or EAWs. For this purpose, the LES offers the AND combination and inversion of multiple analysis windows. The configuration of applications with additional object detection with logic combinations is performed with **LESsoft** (Edit Logical Combinations -> AW Logic panel).

The result of combinations can be output via PROFIBUS or Ethernet. Detailed evaluation results such as, e.g., the status of all EAWs/AWs, the number of measurement points within the EAW/AW and the state of the complete object detection are transmitted via Ethernet. For more information please refer to chapter 10 and chapter 11.



Notice!

An object detection is carried out only within the active EAWs. Areas outside of the measurement range and field of view are likewise not evaluated. An object is detected if the number of measurement values in the EAW reaches or exceeds an arbitrarily defined minimum value.



Notice!

The number of hit points does not necessarily correspond with the object size, since the number of hit points is dependent on distance z . At near distance to the sensor (e.g., 300 mm), an object expanded in the X direction has nearly twice as many hit points as it does at a far distance (e.g., 600mm). If the object distance is the same, the number of hit points remains nearly constant.

5 Installation and mounting

5.1 Storage, transportation



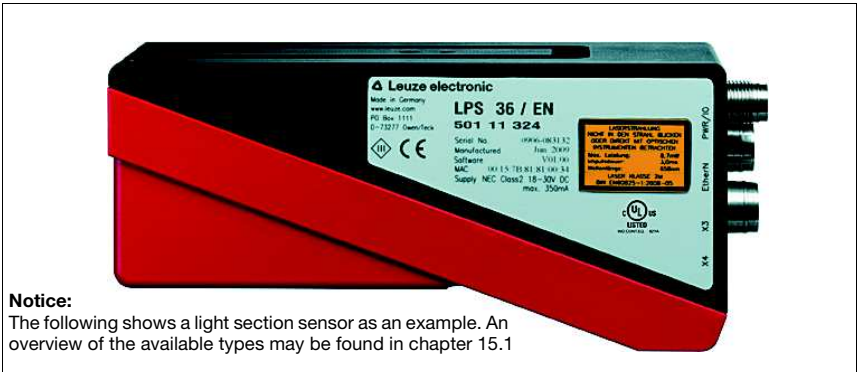
Attention!

When transporting or storing, package the light section sensor so that it is protected against collision and humidity. Optimum protection is achieved when using the original packaging. Heed the required environmental conditions specified in the technical data.

Unpacking

- ☞ Check the packaging for any damage. If damage is found, notify the post office or shipping agent as well as the supplier.
- ☞ Check the delivery contents using your order and the delivery papers:
 - Delivered quantity
 - Device variant and model as indicated on the nameplate
 - Laser warning signs
 - Brief manual

The name plate provides information as to what light section sensor type your device is. For specific information, please refer to chapter 15.



Notice:
The following shows a light section sensor as an example. An overview of the available types may be found in chapter 15.1

Figure 5.1: Device name plate LES

- ☞ Save the original packaging for later storage or shipping.

If you have any questions concerning your shipment, please contact your supplier or your local Leuze electronic sales office.

- ☞ Observe the local regulations regarding disposal of packaging material.

5.2 Mounting the LES

The light section sensors can be mounted in different ways:

- By means of two M4x6 screws on the back of the device
- Using a BT 56 mounting device on the two fastening grooves.
- Using a BT 59 mounting device on the two fastening grooves.

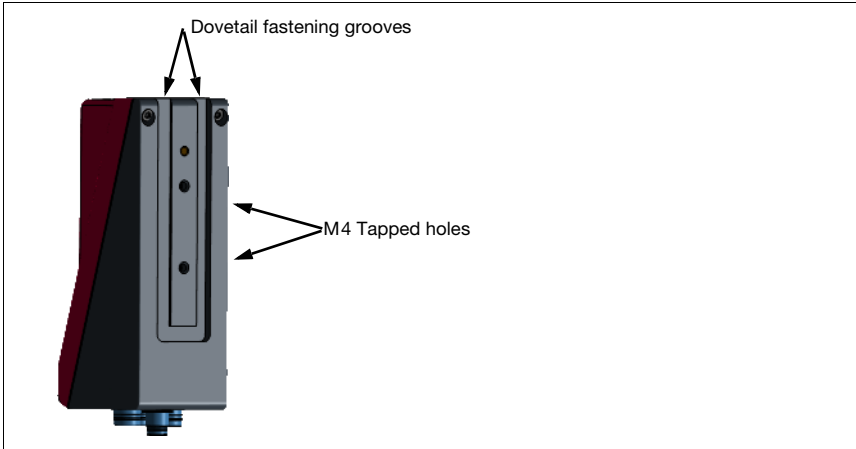


Figure 5.2: Fastening options

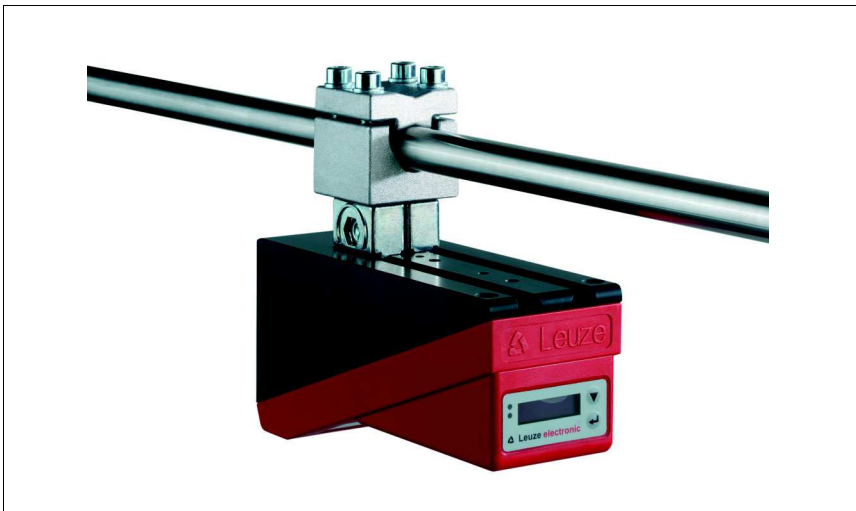


Figure 5.3: Mounting example LES

5.2.1 BT 56 mounting device

The BT 56 mounting device is available for mounting the LES using the fastening grooves. It is designed for rod installation (Ø 16mm to 20mm). For ordering instructions, please refer to chapter "Type overview and accessories" on page 130.

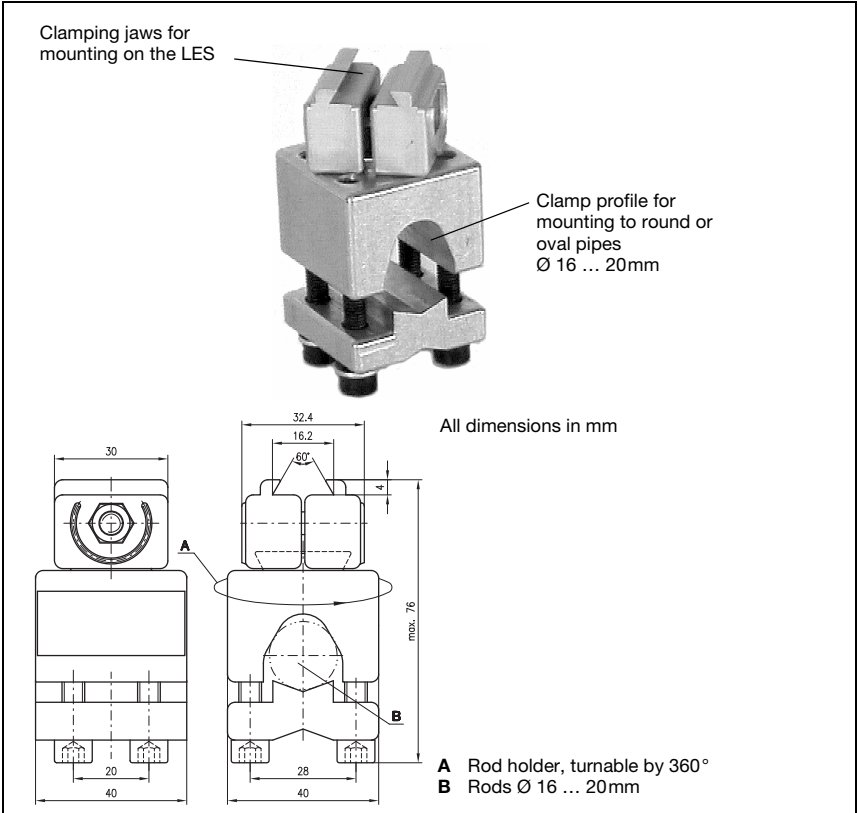


Figure 5.4: BT 56 mounting device

5.2.2 BT 59 mounting device

The BT 59 mounting device is available for mounting the LES on ITEM profiles using the fastening grooves. For ordering instructions, please refer to chapter "Type overview and accessories" on page 130.

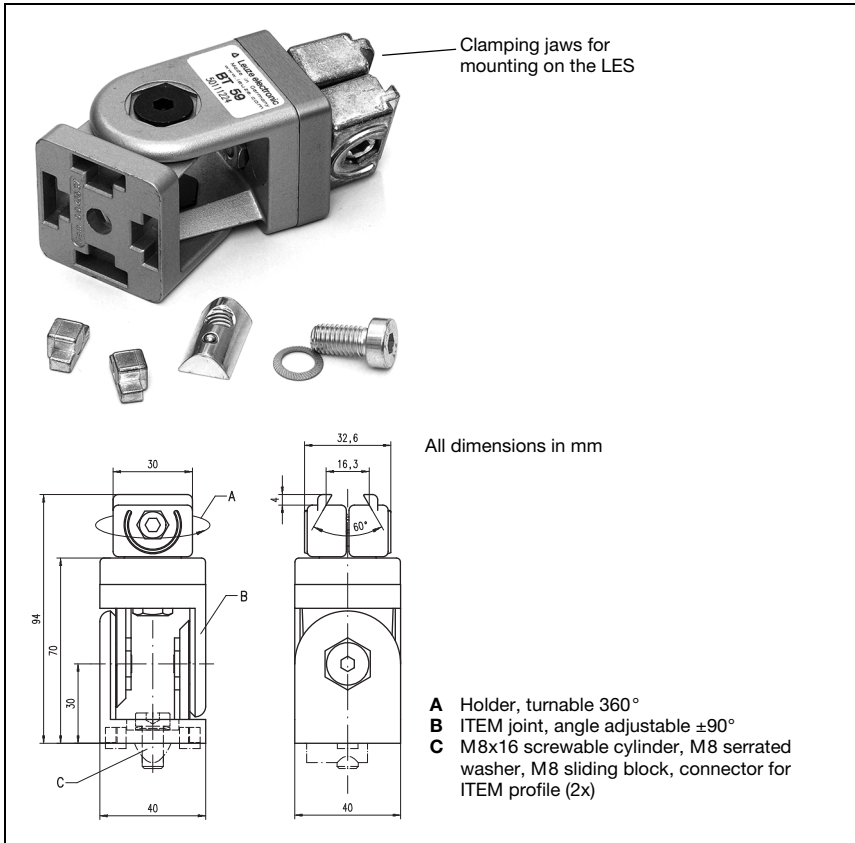


Figure 5.5: BT 59 mounting device

5.3 Device arrangement

5.3.1 Selecting a mounting location

In order to select the right mounting location, several factors must be considered:

- The required resolution. This is a result of the distance and the resulting line length.
- The permissible cable lengths between the LES and the host system depending on which interface is used.
- The display and control panel should be very visible and accessible.

🔗 *When selecting a mounting location, pay further attention to:*

- Maintaining the required environmental conditions (temperature, humidity).
- Possible soiling of the optics covers on transmitter and receiver by discharged liquids, abrasion from cartons or packaging residues.
- Lowest possible chance of damage to the LES by mechanical collision or jammed parts.
- Possible extraneous light (no direct sunlight or sunlight reflected by the measurement object).
- The optimal perspective for detecting the relevant contours of objects, see chapter 3.2.1 "Occlusion".



Attention, laser radiation!

When mounting and aligning the LES, avoid reflections of the laser beam off reflective surfaces!



Notice!

The prevention of ambient light due to shielding of the sensor for example, ensures stable and precise measurement values. Secondary reflections of the laser line on reflective objects must be avoided as these can result in faulty measurements.

The best measurement results are obtained when:

- *You adapt the operating mode (light/dark) to the application.*
- *You do not measure high-gloss objects.*
- *There is no direct sunlight.*

5.3.2 Aligning the sensor

The zero point of the sensor coordinate system is the intersection of optical axis and front edge of the housing. The general principle is that the light section sensor should be aligned so that the back of the sensor is aligned parallel to the conveying belt or measuring plane. Rotation along the Y-axis is not desirable.

The figure 5.6 illustrates the problem:

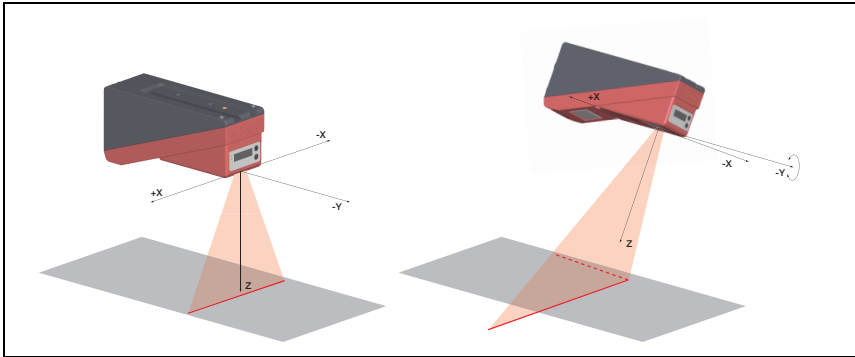


Figure 5.6: Alignment to the measuring plane

A rotation of the sensor about the y-axis distorts the entire coordinate system, which the measurement values relate to. The sensor measures along the solid line in the right picture, however the measuring plane is located on the dotted line, and a measurement towards the conveying belt shown in gray would result in a tilted plane.

When setting up an application it is therefore very important to ensure correct alignment and that the integrated alignment aid on the display is used.

5.4 Attach laser warning sign



Attention Laser!

Observe the safety notices in chapter 2.

⚠ It is essential that you attach the stick-on label (laser warning signs and laser beam exit symbol) supplied with the light section sensor to the light section sensor! If the signs would be concealed as a result of the mounting situation of the LES, attach the signs in the vicinity of the LES such that reading the signs cannot lead to looking into the laser beam!

When installing the LES in North America, also attach the stick-on label saying "Complies with 21 CFR 1040.10"

5.5 Cleaning

⚠ Clean the optics cover of the LES with a soft cloth after mounting. Remove all packaging remains, e.g. carton fibers or styrofoam balls. In doing so, avoid leaving fingerprints on the optics cover of the LES.



Attention!

Do not use aggressive cleaning agents such as thinner or acetone for cleaning the device.

6 Electrical connection

The light section sensors are connected using variously coded M12 connectors. This ensures unique connection assignments.

For the locations of the individual device connections, please refer to the device detail shown below.



Notice!

The corresponding mating connectors and ready-made cables are available as accessories for all connections. For additional information, refer to chapter 15.1.

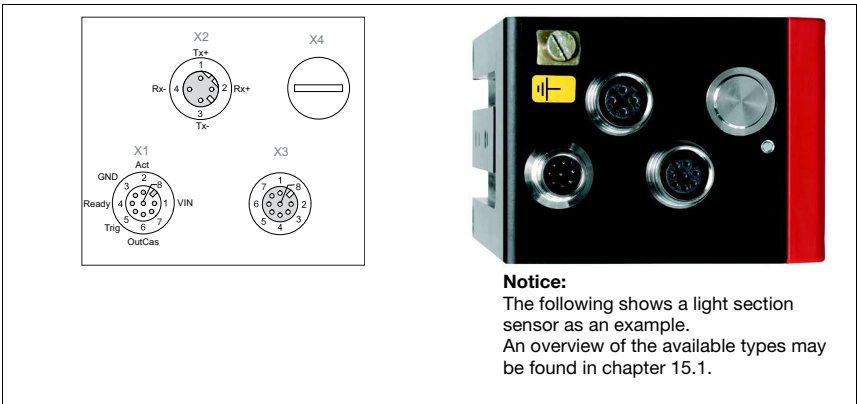


Notice:

The following shows a light section sensor as an example. An overview of the available types may be found in chapter 15.1.

Figure 6.1: Location of the electrical connections

All the light section sensors are equipped with three M12 plugs / sockets which are A- and D-coded.



Notice:

The following shows a light section sensor as an example. An overview of the available types may be found in chapter 15.1.

Figure 6.2: Connections of the LES

The pin assignment of X1 and X2 is identical for all light section sensors; X3 and X4 differ depending on device type.

↳ Using the name plate check the exact type designation. The version of X3/X4 is contained in the following table:

Type designation	X3	X4	Relevant chapter
LES 36/VC6	Switching inputs/outputs	Analog output voltage/current	chapter 6.3.3
LES 36/PB	not used	PROFIBUS	chapter 6.3.4
LES 36HI/VC6	Switching inputs/outputs	Analog output voltage/current	chapter 6.3.3
LES 36HI/PB	not used	PROFIBUS	chapter 6.3.4

Table 6.1: Interface version of X3 and X4

6.1 Safety notices



Attention!

Do not open the light section sensor yourself under any circumstances! There is otherwise a risk of uncontrolled emission of laser radiation from the light section sensor. The housing of the LES contains no parts that need to be adjusted or maintained by the user.

Before connecting the device please ensure that the supply voltage matches the value printed on the nameplate.

Connection of the device and cleaning must only be carried out by a qualified electrician.

If faults cannot be cleared, the LES should be switched off from operation and protected against accidental use.



The LES light section sensors are designed in accordance with safety class III for supply by PELV (protective extra-low voltage with reliable disconnection).



Notice!

Protection class IP 67 is achieved only if the connectors and caps are screwed into place! The connectors used must be equipped with O-ring seals. Therefore, preferably, please use the ready-made cables by Leuze electronic.

6.2 Shielding and line lengths

The light section sensors of the 36/36HI series are equipped with modern electronics developed for industrial applications. In industrial environments, a number of sources of interference may affect the sensors. In the following, information is provided on EMC-compliant wiring of the sensors and of the other components in the switch cabinet and on the machine.

⚡ Observe the following maximum line lengths:

Connection to the sensor	Interface	Max. line length	Shielding
Power supply unit	X1	50m	required
Activation / cascading / trigger	X1	50m	required
PC/Host	X2	50m	required
Encoder	X3	50m	required
Switching inputs/outputs	X3	10m	required
Analog output voltage/current	X4	10m	required
PROFIBUS DP	X4	10m	required

Table 6.2: Line lengths and shielding

Shielding:

1. **Ground the LES housing:**

Connect the housing of the LES via the functional earth (FE) screw provided for this purpose (see figure 6.3, devices produced after April 2011) with the protective conductor on the machine star point. The cable should have an impedance as low as possible for high-frequency signals, i.e., be as short as possible and have a large cross-sectional area (grounding strip, ...).

If the LES does not yet have an FE screw of its own, please use one of the M4 holes on the dovetail.

Important: Place a lock washer underneath and check the penetration of the anodized coating of the LES housing by measuring the electrical connection from FE star point to the connector sleeves without connected sensor cables so that other FE interruptions can be detected on the machine base and profile rails as well.

2. **Shield all connection cables to the LES:**

Apply the shield to FE on both sides. On the LES end, this is ensured if the LES housing is connected to FE (PE) as described under 1. (shield fitted over the connector sleeves to the housing).

In the switch cabinet, clamp the shield flat to FE. To do this, use special **shielding clamps** (e.g., Wago, Weidmüller, ...).

Keep the length of the shieldless end of the cable as short as possible.

The shield should not be connected at a terminal in a twisted fashion (no "RF braid").

3. **Disconnect power and control cables:**

Lay the cables for the power components (motor cables, lifting magnets, frequency inverters, ...) as far from the sensor cables as possible (distance > 30cm). Avoid laying power and sensor cables parallel to one another.

Cable crossings should be laid as perpendicular as possible.

4. **Lay cables close to grounded metal surfaces:**

This measure reduces interference coupling in the cables.

5. **Avoid leakage currents in the cable shield:**

Leakage currents arise from incorrectly implemented equipotential bonding. Therefore, carefully ground all parts of the machine.

Notice: You can measure leakage currents with a clip-on ammeter.

6. **Star-shaped cable connections:**

To avoid interference between various consumers, ensure that the devices are connected in a star shape. This will prevent cable loops.

General shielding information:

Avoid spurious emissions when using power components (frequency inverters, ...). The technical descriptions of the power components provide the necessary specifications according to which the respective power component satisfies its CE conformity.

In practical work, the following measures have proven effective:

- Screw the mains filter, frequency inverter flat on the galvanized mounting plate.
- Mounting plate in the switch cabinet made of galvanized sheet steel, thickness ≥ 3 mm.
- Keep cable between mains filter and inverter as short as possible and twist cables.
- Shield both ends of the motor cable.
- Ground the entire system well.

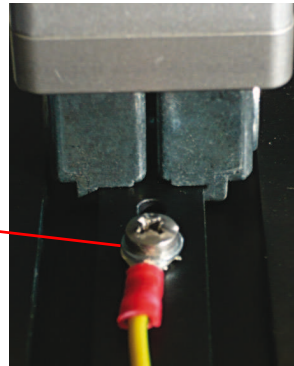
Carefully ground all parts of the machine and of the switch cabinet using copper strips, ground rails or grounding cables with large cross section.

Below, the EMC-compliant connection of the light section sensors LES is described in practical use with images.

Connect the ground potential to the light section sensors



Attention!
Place lock washer underneath and check the penetration of the anodized coating!

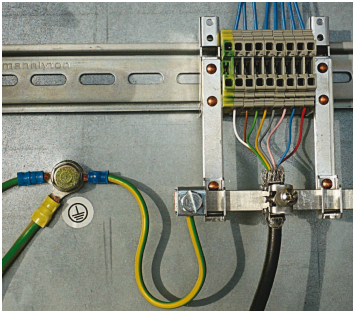


Devices produced after April 2011 are equipped with an additional grounding terminal.

All devices can also be connected to ground potential at the M4 threaded hole on the dovetail.

Figure 6.3: Connecting the ground potential to the light section sensor

Connecting the cable shield in the switch cabinet



- Shield connected flat to PE
- Connect PE star point with short cables
- Galvanized mounting sheet steel

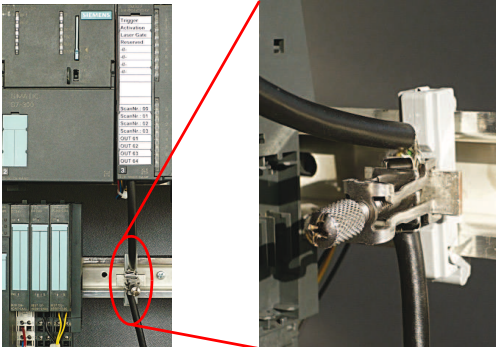
Comment:

Depicted shield components from Wago, series 790 ...:

- 790-108 Shield clamping bracket 11 mm
- 790-300 Busbar holder for TS35

Figure 6.4: Connecting the cable shield in the switch cabinet

Connecting the cable shield to the PLC



- Where possible, use shielded sensor cables
- Connect shield flat to PE using shield clamping system
- Mounting rails must be well grounded

Comment:

Depicted shield components from Wago, series 790 ...:

- 790-108 Shield clamping bracket 11 mm
- 790-112 Carrier with grounding foot for TS35

Figure 6.5: Connecting the cable shield to the PLC

6.3 Connecting

6.3.1 Connection X1 - logic and power



Attention!

All cables must be shielded!

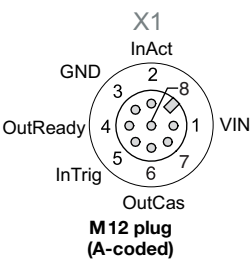
X1 (8-pin plug, A-coded)				
 <p>M 12 plug (A-coded)</p>	Pin	Name	Core color	Remark
	1	VIN	WH	+24VDC supply voltage
	2	InAct	BN	Activation input
	3	GND	GN	Ground
	4	OutReady	YE	"Ready" output
	5	InTrig	GY	Trigger input
	6	OutCas	PK	Cascading output
	7		BU	Do not connect
	8		RD	Do not connect

Table 6.3: Pin assignment X1

☞ Preferably, please use the ready-made cables "K-D M12A-8P...", see chapter 15.2.2.

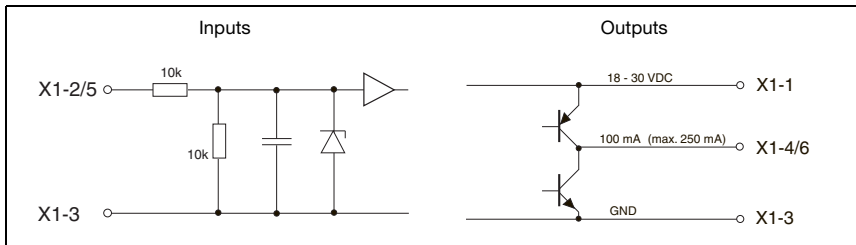


Figure 6.6: Internal wiring at X1

Power supply

For power supply specifications please refer to chapter 14.

Activation input InAct

The activation input is used to switch the laser on and off via the process control. The sensor stops outputting data and does not respond to trigger commands or the trigger input. The equivalent circuit of the inputs at X1 is shown in figure 6.6.

Trigger input InTrig

The trigger input is used for synchronizing the measurement with the process and for synchronizing cascaded sensors. Detailed information on this topic can be found in chapter 4.2.3 and chapter 4.2.4. The internal equivalent circuit is shown in figure 6.6.

Cascading output OutCas

In order to operate several light section sensors cascaded this output must be connected directly to the trigger input of the following sensor. Detailed information on this topic can be found in chapter 4.2.4. The internal equivalent circuit is shown in figure 6.6.

Output "ready" OutReady

This output indicates operational readiness of the sensor. The state of the output corresponds to the state of the green LED (see "LED status displays" on page 52).

6.3.2 Connection X2 - Ethernet



Attention!

All cables must be shielded!

The LES makes either the Ethernet interface available as host interface.

X2 (4-pin socket, D-coded)				
	Pin	Name	Core color	Remark
<p>M12 socket (D-coded)</p>	1	Tx+	YE	Transmit Data +
	2	Rx+	WH	Receive Data +
	3	Tx-	OR	Transmit Data -
	4	Rx-	BU	Receive Data -
	Thread	FE	-	Functional earth (housing)

Table 6.4: Pin assignment X2

☞ Preferably, please use the ready-made cables "KB ET-...-SA...", see chapter 15.2.3.

Ethernet cable assignment

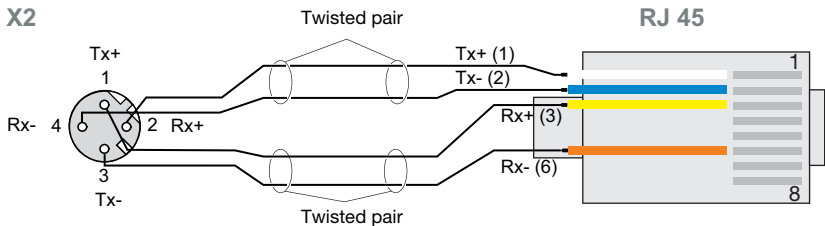


Figure 6.7: HOST / BUS IN cable assignments on RJ-45



Notice for connecting the Ethernet interface!

Ensure adequate shielding. The entire connection cable must be shielded and earthed. The Rx+/Rx- and Tx+/Tx- wires must be stranded in pairs. Use CAT 5 cables for the connection.

6.3.3 Connection X3 - switching inputs/outputs (LES 36.../VC6)

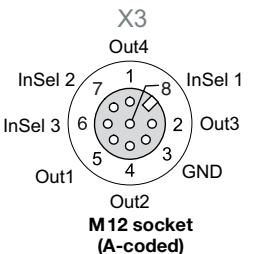
X3 (8-pin socket, A-coded)				
 <p style="text-align: center;">X3 M12 socket (A-coded)</p>	Pin	Name	Core color	Remark
	1	Out4	WH	Output detection result 4
	2	Out3	BN	Output detection result 3
	3	GND	GN	Ground
	4	Out2	YE	Output detection result 2
	5	Out1	GY	Output detection result 1
	6	InSel3	PK	Selection Inspection Task Bit 3 (MSB)
	7	InSel2	BU	Selection Inspection Task Bit 2
	8	InSel1	RD	Selection Inspection Task Bit 1 (LSB)

Table 6.5: Pin assignment X3

Switching outputs of connection X3

Out1 to Out4 are each a logic combination of analysis results of the individual AWs. This logic operation is defined in LRSsoft (see chapter 9.4 "Parameter settings/Parameters tab"). Up to 16 different logic combinations of the AWs and respective result mappings on Out1 to Out4 can be combined into inspection tasks.

Switching inputs of connection X3

The 3 switching inputs InSel1-3 are used to select the inspection task 0-7. In this context, "000" stands for Inspection Task 0, "001" for Inspection Task 1, etc. The switching time between 2 inspection tasks is < 100ms



Notice!

The Inspection Tasks 8-15 can be switched via PROFIBUS or Ethernet. The setting via Ethernet overwrites the inspection task set via input InSel1-3.

6.3.4 Connection X4 - PROFIBUS DP (LES 36.../PB)

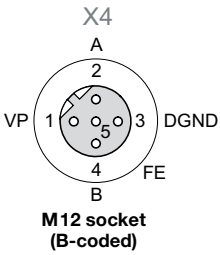
X4 (5-pin socket, B-coded)			
	Pin	Name	Remark
		1	VP
	2	A	Receive/transmit data RxD/TxD-N, green
	3	DGND	Data reference potential
	4	B	Receive/transmit data RxD/TxD-P, red
	5	FE	Functional earth
	Thread	FE	Functional earth (housing)

Table 6.6: Pin assignment X4 for LES 36.../PB



Notice!

Connection X4 PROFIBUS DP is assigned only on the LES 36/PB and LES 36HII/PB.

The connection to the PROFIBUS DP is made via the 5-pole X4 M12-socket with an external Y plug adapter. Assignments correspond to the PROFIBUS standard. The Y plug adapter enables the replacement of the LES 36.../PB without interrupting the PROFIBUS cable.

The external Y plug adapter is also needed if the LES 36.../PB is the last network device. The external bus terminating resistor (termination) is then connected to this. The 5V-supply for the termination is connected to X4.



Notice!

For the connection, we recommend our ready-made PROFIBUS cables (see chapter 15.2 "Accessories")

For the bus termination, we recommend our PROFIBUS terminating resistor (see chapter 15.2 "Accessories")

6.3.5 Connection X4 - voltage/current output (LES 36.../VC6)

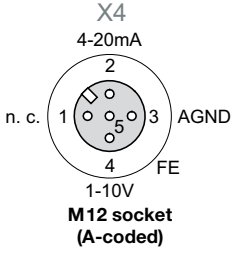
X4 (5-pin socket, A-coded)				
 <p>Diagram of X4 5-pin socket (A-coded) showing pin assignments: Pin 1 (n.c.), Pin 2 (4-20mA), Pin 3 (AGND), Pin 4 (FE), Pin 5 (1-10V). The socket is labeled M12 socket (A-coded).</p>	Pin	Name	Core color	Remark
	1	n.c.	BN	not used
	2	4-20mA	WH	Analog current output
	3	AGND	BU	Reference potential for the analog output
	4	1-10V	BK	Analog voltage output
	5	FE	GY	Functional earth
	Thread	FE		Functional earth (housing)

Table 6.7: Pin assignment X4 for LES 36.../VC6



Notice!

Connection X4 analog output is assigned only on the LES 36/VC6, LES 36HI/VC6. Analog outputs 1-10V (voltage) and 4-20mA (current) may only be used alternately; the selection is made with LESSoft in the Analog Output tab.

Connection of the analog output is made via the 5-pin, M12-socket X4.



Attention!

When connecting the analog output, note the permissible load resistance:

- Voltage output 1 ... 10VDC: $R_L \geq 2k\Omega$
- Current output 4 ... 20mADC: $R_L \leq 500\Omega$

Characteristic curve of the analog output

Response of the analog output

The LES is equipped with an analog output with linear response within the respective measurement range. There is a departure from linearity above and below the linear area. In spite of this, values above the maximum ($> 20\text{mA}$ or $> 10\text{V}$) or below the minimum ($< 4\text{mA}$ or $< 1\text{V}$) specified for the measurement range can still clearly be seen for the output values.

The analog output can be conveniently configured with LESSoft. To obtain the most exact resolution possible, the range of the analog output should be set as small as the application will permit (the minimum adjustment range is 10mm). The characteristic output curve can be configured as rising or falling. For this purpose, both distance values Position Min. Val. and Position Max. Val. for the minimum and maximum analog output value are set accordingly, see figure 6.8.

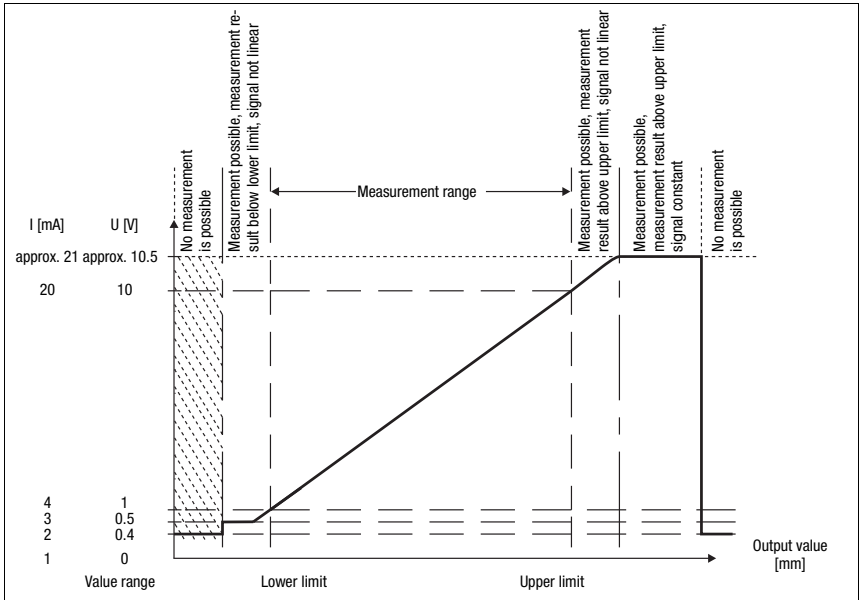


Figure 6.8: Response of analog output LES

Possible value ranges depending on set analog output value:

	LES 36...	LES 36HI...
X-coordinate	-300 ... +300mm	-70 ... +70mm
Z-coordinate	+200 ... +800mm	+200 ... +800mm
Height difference	0 ... 600mm	0 ... 400mm
Width	0 ... 600mm	0 ... 140mm



Notice!

Valid Z-values are output 10mm above and beyond the max. measurement range: 190 ... 810mm.

7 Display and control panel

7.1 Indicator and operating elements of the

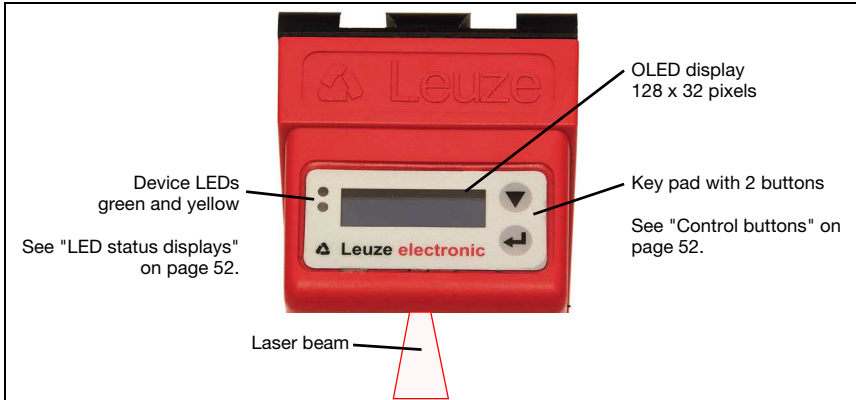


Figure 7.1: Indicator and operating elements of the LES

After switching on the supply voltage $+U_B$ and following error-free initialization of the device, the green LED illuminates continuously: the LES is in measure mode. The OLED display shows the alignment aid and the status display.

7.1.1 LED status displays

LED	State	Display during measurement operation
green	continuous light	Sensor ready
	off	Sensor not ready
yellow	continuous light	Ethernet connection established
	flashing	Ethernet data transmission active
	off	No Ethernet connection

Table 7.1: LED function indicator

7.1.2 Control buttons

The LES is operated using the ▼ and ← buttons, which are located next to the OLED display.

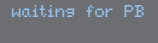
7.1.3 Displays

The display changes depending on the current operating mode. There are the following three display modes:

- Alignment aid and status display
- Command mode
- Menu display

The menu display is accessed by pressing one of the two control buttons. Operation of the LES via the menu is described in chapter 7.2.2.

With PROFIBUS devices, the bus state is first displayed after power-on (displayed for approx. 3s). If the PROFIBUS was detected, alignment aid and status are then displayed.



Alignment aid

As an alignment aid, the current measurement value at the left edge (Lxxx), in the middle (Mxxx) and at the right edge (Rxxx) of the detection range is displayed in the OLED display in units of millimeters. If no object is detected or if the distance is too small, distance value 000 (mm) appears in the display.



↻ Align the light section sensor by rotating it about the y-axis in such a way that the same value is indicated for L, M, R.

Status display

Displayed on the second line of the display is the selected inspection task (Txx), a measurement value as well as the current sensor state (see chapter 4.2 "Operating the sensor").



The indication of the sensor state in the display has the following meaning:

- fRun = Free Running
- TriΣ = Triggering
- !Act = Activation (laser on/off)

T12 means that Inspection Task 12 is currently active, for example. Value range: T00 to T15.

Meaning of the measurement value display:

- X-151 means that the X-coordinate of the right-most measurement point is at position -151mm.
- x 040 means that the X-coordinate of the left-most measurement point is at position +40mm.
- Z 600 means that the Z-coordinate of the right-most measurement point is at position 600mm.
- Z 500 means that the Z-coordinate of the left-most measurement point is at position +500mm.
- W 230 means that the width of the object is 230mm.
- H 059 means that the height of the object is 59mm.

Definition of the displayed measurement value:

- For analog sensors, the measurement value assigned to the analog output is displayed in mm.
- For sensors with PROFIBUS, the measurement value assigned under **Edge 1 - Profibus Inputs 1** is displayed.

If, for PROFIBUS devices, no PROFIBUS is detected following power-on, no PB appears in the middle of the bottom line.



The following options are available for the sensor status: fRun means Free Running, Tri \bar{a} means triggered (see chapter 4.2.3 "Triggering - Free Running") and !ACK means that the sensor is deactivated (no laser line, see chapter 4.2.2 "Activation - laser on/off").

Command mode

If the LES is connected to a control, the control can put the LES into a command mode in which it receives and executes commands (see chapter 10.2.9 "Evaluation telegram"). In command mode, the OLED display has one line.

Command Mode appears on the first line of the display.




Notice!

If errors occur during operation, these are shown on the display. Notices can be found in chapter 12.3.

7.2 Menu description

7.2.1 Structure

Level 1	Level 2	Level 3	Level 4	Explanation / Notes	Default
Select Insp. Task Appl. Settings				Select Inspection Task menu item	
	Ext. Selection Enabled			Change task via digital inputs (external)	
		Ext. Selection Enabled		Change task via digital inputs (external) is activated	X
		Ext. Selection Disabled		Change task via digital inputs (external) is deactivated ¹⁾	
	Select Insp. Task 00:Task 0			Selection of the active inspection task ²⁾	
		Select Insp. Task 00:Task 0		Task 0 is activated	X
		:		:	
		Select Insp. Task 15:Task 15		Task 15 is activated	
	← Ext. Selection			Return to menu level 1	
Appl. Settings ³⁾ Device Settings				Application Settings menu item	
	Exposure Time Normal Mode			Exposure time for measurements and teaching	
		Exposure Time Normal Mode		"Normal" exposure time setting	X
		Exposure Time Bright Objects		"Bright Objects" exposure time setting	
		Exposure Time Dark Objects		"Dark Objects" exposure time setting	
		Exposure Time Manual Setting		"Manual" exposure time setting (user-specific setting) ⁴⁾	
	Trigger Mode Free Running			Trigger mode for measurements	
		Trigger Mode Free Running		"Free Running" trigger setting (continuous measurement)	X
		Trigger Mode Input Triggered		"Input Triggered" trigger setting (trigger-input signal triggers measurement)	
	← Exposure Time			Return to menu level 1	
Device Settings Error Handling				Device Settings menu item	
	Slave Address Ethernet			PROFIBUS DP slave address ⁵⁾	
		Slave Address 126		Setting for the PROFIBUS DP slave address	126
	Ethernet Display			Ethernet interface parameters ⁶⁾	
		IP Address 192.168.060.003		IP address of the sensor	

Table 7.2: Menu structure

Level 1	Level 2	Level 3	Level 4	Explanation / Notes	Default
			IP Address 192.168.060.003	Setting for the IP address (default: 192.168.060.003)	X
		Net Mask Address 255.255.255.000		Subnet mask of the sensor	
			Net Mask Address 255.255.255.000	Setting for the subnet mask (default: 255.255.255.000)	X
		Std. Gateway 000.000.000.000		Default gateway for Ethernet communication	
			Std. Gateway 000.000.000.000	Setting for the IP address of the default gateway (default: 000.000.000.000)	X
		Port Num. Local 09008		Local port of the sensor for Ethernet communication	
			Port Num. Local 09008	Setting for the local port	9008
		Port Num. Dest. 05634		Destination port of the PC or control for Ethernet communication	
			Port Num. Dest. 05634	Setting for the destination port	5634
		← IP Address		Return to menu level 2	
	Display On			Display settings	
		Display On		Setting "On": always on with maximum brightness	
		Display Off		Setting "Off": off; is switched back on after keyboard actuation	
		Display Auto		Setting "Auto": full brightness for approximately 1 minute after button is pressed, then dimmed	X
	Password Check Inactive			Password protection for menu access	
		Password Check Inactive		Password protection deactivated	X
		Password Check Activated		Password protection activated (permanent password: "165")	
	← Slave Address			Return to menu level 1	
Error Handling Info				Error Handling menu item	
	Reset to Factory Cancel			Reset to factory settings	
		Reset to Factory Cancel		Do not execute reset	
		Reset to Factory Execute		Execute reset with subsequent confirmation prompt	
	← Reset to Factory			Return to menu level 1	
Info ← Menu Exit				Device Information menu item	
		Part no. 50115418		Leuze part number of the sensor	

Table 7.2: Menu structure

Level 1	Level 2	Level 3	Level 4	Explanation / Notes	Default
	Serial No. 01408004336			Serial number of the sensor	
	Ext. Info K000			Leuze-internal information	
	Software V01.50			Software version of the sensor	
	← Part no.			Return to menu level 1	
← Menu Exit Select Insp. Task				Exit menu and return to measure mode	

Table 7.2: Menu structure

- 1) The inspection tasks can be switched via the control panel.
- 2) The setting of the active inspection task applies only if "Ext. Selection" = "Disabled"
- 3) The application settings apply for the currently selected inspection task. Individual application settings can be made for each task.
- 4) With "Manual Settings", the value preset via LRSsoft is used.
- 5) This menu item exists only with the PROFIBUS device versions.
- 6) The values configured here are not applied immediately but only when the sensor is switched on the next time.



Notice!

If no button is pressed for three minutes, the LES exits menu mode and switches to measure mode. The OLED display again displays the alignment aid and the sensor status display.



Notice!

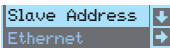
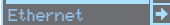


After changing the PROFIBUS slave address, a power-on reset must be performed in order to permanently accept the address.

7.2.2 Operation/navigation



In menu view, the OLED display has two lines. The currently active menu item is displayed with black text on a light-blue background. The ▼ and ← buttons both have different functions depending on the operating situation. These functions are represented via icons on the right edge of the display – i.e. to the immediate left of the buttons.

The following displays may appear:



Menu navigation


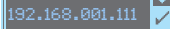
- | | |
|---|--|
|  | ▼ selects the next menu item (Ethernet) |
|  | ← switches to the submenu shown with inverted colors (Slave Address) |
|  | ▼ selects the next menu item (IP Address) |
|  | ← returns to the next higher menu (←). At the top menu level, the menu can be exited here (Menu Exit). The number of bars at the left edge indicates the current menu level: |


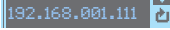
Selecting values or selection parameters for editing



- | | |
|---|--|
|  | ▼ selects the next menu item (-> Net Mask Addr.) |
|  | ← selects edit mode for IP Address |

Editing value parameters


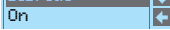
- | | |
|---|---|
|  | ▼ decrements the value of the currently selected digit (1). |
|  | ← selects the next digit to the right (9) for editing. After having clicked through all the digits using ← a checkmark (☑) appears at the bottom right of the display. If an impermissible value was entered, the ∞ symbol (new entry) appears and no checkmark is offered for selection. |




- | | |
|--|--|
|  | ▼ changes the edit mode, ∞ appears. |
|  | ← saves the new value (192.168.001.111). |

- | | |
|---|--|
|  | ▼ changes the edit mode, ☒ appears. |
|  | ← selects the first digit (1) for renewed editing. |

- | | |
|---|--|
|  | ▼ changes the edit mode, ∞ ☒ appears. |
|  | ← rejects the new value (in this example, the factory setting 192.168.060.003 remains saved) |

Editing selection parameters

- | | |
|---|---|
|  | ▼ displays the next option for Display (Off). |
|  | ← returns to the next-higher menu level and retains On. |

- 
▼ displays the next option for Display (Auto).
 ↵ selects the new value Off and displays the menu for confirmation:
- 
▼ changes the edit mode, ☒ appears.
 ↵ saves the new value (Off).
- 
▼ changes the edit mode, ☒ appears.
 ↵ rejects the new value (On remains saved).



Notice

To ensure that values that were changed via the menu are also applied, you should disconnect the sensor from its power supply for a brief period after a change of values.

7.3 Reset to factory settings

The factory settings can be reset in three different ways:

- Hold down the ↵ button while connecting the supply voltage
- Factory Setting menu item
- By means of the LESsoft configuration software

As an example, the first of the methods mentioned above is described below:

🔗 When applying the supply voltage, press the ↵ button to reset the configuration of the LES to factory settings.

The display shown next to here appears.



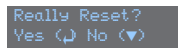
Interrupting a reset

Pressing ▼ causes the adjacent display to appear. If you now press the ↵ button, you will exit the menu without resetting the LES to factory settings.

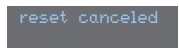


Executing a reset

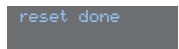
Pressing the ↵ button while the checkmark (☒) is displayed causes the adjacent safety prompt to appear.



Pressing ▼ interrupts the reset process; `reset canceled` appears in the display for approx. 2s. Afterward, the LES returns to measure mode.



Pressing ↵ resets all parameters to the factory settings. All settings made previously are permanently lost. `reset done` appears in the display for approx. 2s; the LES then returns to measure mode.



You can select the resetting to factory settings also via LESsoft.

🔗 In the Configuration menu select the entry `Reset to Factory Settings`.

8 Commissioning and configuration

8.1 Switching on

After switching on the supply voltage $+U_B$ and following error-free initialization of the device, the green LED illuminates continuously: the LES is in measure mode.



Notice

After a warmup time of 30 min., the light section sensor has reached the operating temperature required for an optimum measurement.

8.2 Establish connection to PC

The LES is configured via a PC using the LESsoft program before it is integrated into the process control.

In order to be able to establish an UDP communication with the PC, the IP address of your PC and the IP address of the LES must lie in the same address range. The LES has no built-in DHCP client, so that you need to set the address manually. This is done the easiest way via the PC.



Notice!

If you use a desktop firewall, please make certain that the PC can communicate with the LES via the Ethernet interface by means of UDP on ports 9008 and 5634 (these ports are preset at the factory, but may have been changed by the user, see chapter 7.2 "Menu description"). Furthermore, the firewall must allow ICMP echo messages to pass through for the connection test (ping).

If the PC is usually connected to a network using DHCP address allocation, the easiest way to access the LES is by applying an alternative configuration in the TCP/IP settings of the PC and connecting the LES to the PC.

☞ To check the network address of the LES, switch to the Settings menu from detection mode of the LES with the touch of a button.

In the Ethernet submenu (see chapter 7.2.1), you can read the current settings of the LES one after the next by pressing ▼.

☞ Make a note of the values for IP-Address and Net Mask Addr..

The value in Net Mask Addr. specifies which digits of the IP address of the PC and LES must match so that they can communicate with each other.

Address of the LES	Net mask	Address of the PC
192.168.060.003	255.255.255.0	192.168.060.xxx
192.168.060.003	255.255.0.0	192.168.xxx.xxx

Table 8.1: Address allocation in the Ethernet

Instead of **xxx** you can now allocate any numbers between 000 and 255 to your PC, but NOT THE SAME numbers as contained in the address of the LES.

For example 192.168.060.110 (but not 192.168.060.003!). If LES and PC have the same IP address, they cannot communicate with each other.

Setting the default gateway

The IP address for the default gateway can optionally be set using the **Std. Gateway** submenu item (default: 000.000.000.000).



Notice

The IP address of the default gateway (**Std. Gateway**) and the destination port of the PC or control (**Port Num. Dest.**) are stored in the sensor configuration beginning with firmware V01.50 and LRSsoft V2.40.

Setting an alternative IP address on the PC

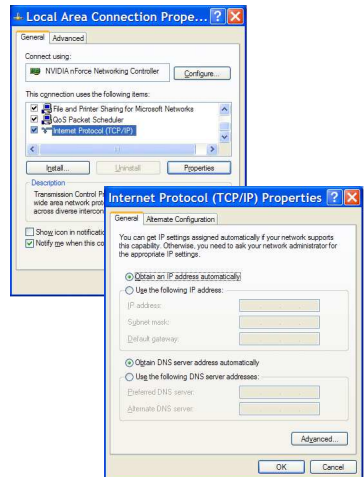
- ☞ Log into your PC as administrator.
- ☞ Using Start->System control go to the Network connections (Windows XP) menu or to the Network center and release center (Windows Vista) menu.
- ☞ There, select LAN Connection and right-click to open the corresponding Properties page.
- ☞ Select the Internet protocol (TCP/IP) (by scrolling down, if necessary) and click on Properties.
- ☞ In the Internet protocol (TCP/IP) Properties window select the Alternate configuration tab.
- ☞ Set the IP address of the PC in the address range of the LES.

Attention: do not use the same as for the LES!

- ☞ Set the subnet mask of the PC to the same value as on the LES.
- ☞ Close the configuration dialog by confirming all windows using OK.
- ☞ Connect the interface X2 of the LES directly to the LAN port of your PC. Use a KB ET-...-SA-RJ45 cable for the connection, see table 15.9

The PC first tries to establish a network connection via the automatic configuration. This takes a few seconds, after which the alternate configuration, which you just set, is activated. The PC can now communicate with the LES.

Information about configuring with the LESsoft can be found in chapter 9.

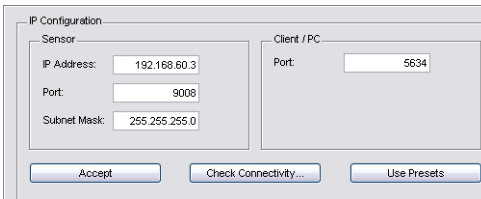


8.3 Commissioning

For the commissioning and integration of the sensor in the process control the following steps are necessary:

1. LES configuration - see chapter 9.
2. Programming process control - see chapter 10 and chapter 11.
or
3. Connect analog output accordingly - see chapter 6.3.5.
4. Connect switching inputs and outputs accordingly - see chapter 6.3.3.
5. When connecting in the Ethernet process controls, the IP configuration of the LES is to be adjusted so that the LES can communicate with the process control.

The values corresponding to the following screenshot are preset in the LES at the factory. If you would like to set different values, you must change the values via the display of the LES in menu item Ethernet (see "Menu description" on page 55). You can test the changed values by entering them in the Configuration area in LESsoft and then clicking the Check Connectivity button.



6. Connect LES to the process control. This can be performed for all LES via the Ethernet interface or, depending on model, via the analog outputs or the PROFIBUS.
7. Establish connections for activation, triggering and cascading, if necessary.



Notice on connecting multiple light section sensors via Ethernet

*If several sensors are to be activated, all sensors as well as the control must receive **different IP addresses** on the same subnet. For all sensors **different ports** must be configured in the Sensor area as well as in the Client/PC area.*

9 LESsoft configuration software

9.1 System requirements

The PC used should meet the following requirements:

- Pentium® or faster Intel® processor > 1.5 GHz (Pentium 4, Celeron, Xeon) or compatible models by AMD® (Athlon 64, Opteron, Sempron)
The processor must support the SSE2 instruction set
- At least 512 MB free main memory (RAM), 1024 MB recommended
- CD-ROM drive
- Hard disk with at least 1 GB available memory
- Ethernet port
- Microsoft® Windows XP from Service Pack 2 / Windows 7

9.2 Installation

**Notice!**

If present, uninstall Matlab Runtime before beginning with the installation of the LXSsoft Suite.

The **LXSsoft_Suite_Setup.exe** installation program is located on the supplied CD. Alternatively, you can download the program in the Internet at **www.leuze.com**.

**Notice!**

Copy this file from the CD to an appropriate folder on your hard drive. **Administrator privileges are necessary** for this purpose.

Please note that the standard text size setting is used. For Windows XP, the necessary DPI setting is 96 DPI, for Windows 7, the display is to be set to "Smaller - 100%".

☞ To start the installation process, double-click on file **LXSsoft_Suite_Setup.exe**.

☞ In the first window, click on **Next**.

In the next window, you can select which configuration software you would like to install.

You will need **LPSsoft** for configuring light section sensors of the **LPS** series.

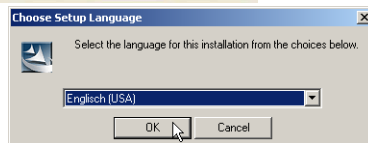
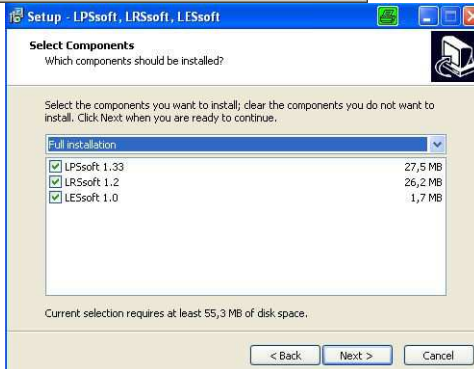
You will need **LRSsoft** for configuring light section sensors of the **LRS** series.

You will need **LESsoft** for configuring light section sensors of the **LES** series.

☞ Select the desired options and click on **Next** and, in the next window, click on **Install**.

The installation routine starts. After a few seconds, the window for selecting the installation language for the Matlab Compiler Runtime (MCR) appears. The MCR is used for the configuration in LESsoft. It is only available in English or Japanese.

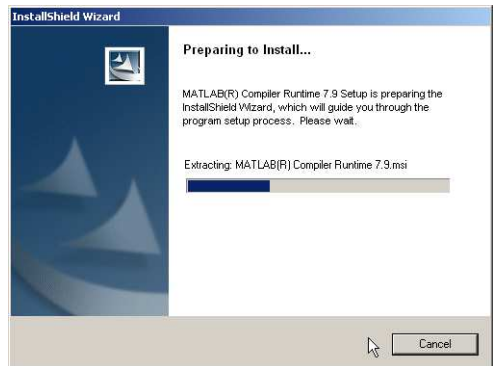
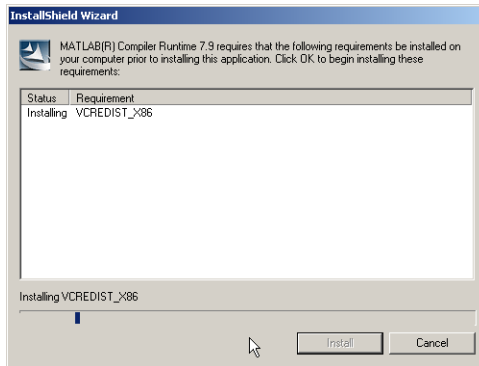
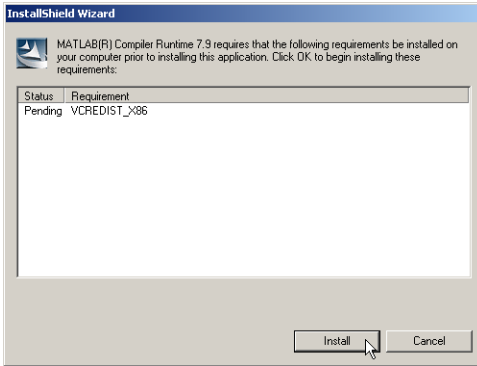
☞ Therefore keep in the **Choose Setup Language** window the selection **English** and click on **OK**.



Depending on the configuration of your Windows system, the dialog shown below may then appear (missing component VCREDIST_X86).

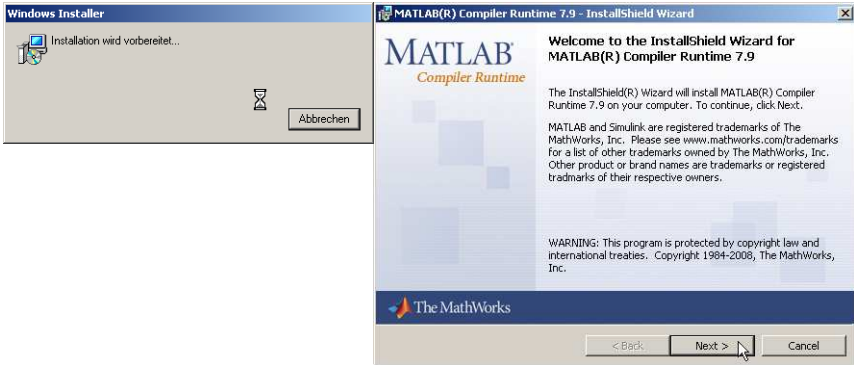
↳ *Click on Install.*

Two additional installation windows will appear, which do not require any further entry.



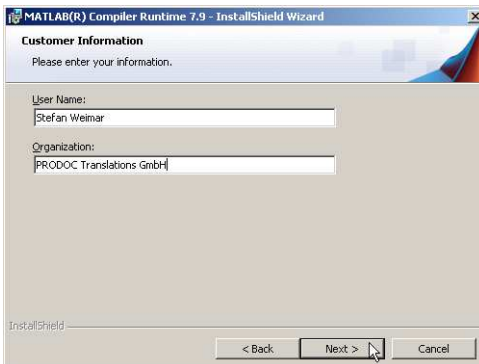
After some time (up to several minutes depending on the system configuration) the start screen of the MCR installer will appear.

☞ Click on Next.



The window for entering user data appears.

☞ Enter your name and the company name and then click on Next.



☞ *It is essential that you retain the default folder in the window for the selection of the installation path (Destination Folder).*

The standard path is C:\Programs\MATLAB\MATLAB Compiler Runtime\.

☞ *Click on Next and in the next window click on Install.*

The installation will start and a status window will be displayed. This can again take several minutes.

Following successful MCR installation, the InstallShield Wizard Completed window appears.

☞ *Click on Finish to end the MCR-installation.*



The window for selecting the installation path for LESsoft/LPSsoft/LRSsoft now appears (provided you selected this option).



☞ *Keep the default folder and click on Next.*

The installation of **LPSsoft** starts. If you also selected **LRSsoft** and **LESsoft** for installation, upon completion of the **LPSsoft** installation, the same window then reappears for entering the installation path for **LRSsoft** and **LESsoft**.

☞ *Keep the default folder in this case as well and click on Next.*

Upon completion of the installation process, the window shown above appears.

The installation routine added a new **Leuze electronic** program group in your Start menu that contains the installed programs **LESsoft/LPSsoft/LRSsoft**.

☞ *Click on Finish and then start the desired program from the Start menu.*

9.2.1 Possible error message

Depending on the setting of the display, the "Width and Height must be >0" error message may be output. The cause is an incompatible setting of the display.



Notice!

For Windows XP, the necessary DPI setting is 96 DPI. For Windows 7, the display is to be set to "Smaller - 100% (default)".

The setting can be adjusted as follows.

- ✧ Adjust the display for Windows XP by selecting the value "96 DPI" under Properties -> Display -> Settings -> Extended -> Display -> DPI setting.
- ✧ For Windows 7, adjust the display via Control Panel -> Display by setting the display to "Smaller - 100% (default)".

Depending on the system configuration the adjacent error message can appear at this point.



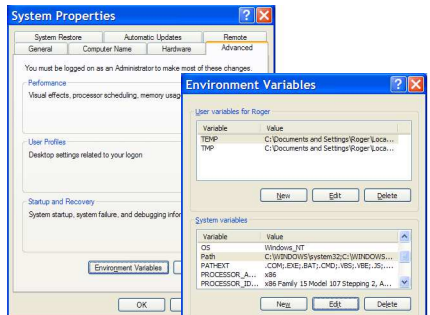
The cause of this error message is a bug in the MCR installation routine, which does not set the environment variable Path correctly in some systems.

That, however, can easily be corrected without reinstallation of the MCR.

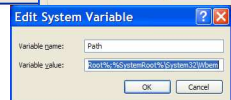
- ✧ Open the System properties window located in the System control of Windows under System.
- ✧ Go to the Advanced tab and click on Environment variables.

The Environment variables window opens.

- ✧ Scroll down in the System variables area until you find the Path entry.
- ✧ Click on Path and then on Edit



The Edit system variable window opens.



There in the Variable value field you will find the ;C:\Programs\MATLAB\MATLAB Compiler Runtime\v79\runtime\win32 entry right at the end.

- ✧ If this entry is missing, copy the entry from this document and insert it together with the preceding semicolon.
- ✧ Then click on OK and close also all further windows using OK.
- ✧ Shut Windows down, restart Windows and then start LESsoft by double-clicking on it.

Now the start screen of LESsoft appears, as described in chapter 9.3.

9.3 Starting LESsoft/Communication tab

☞ Start **LESsoft** via the respective entry in the Windows Start menu.

The following screen appears:

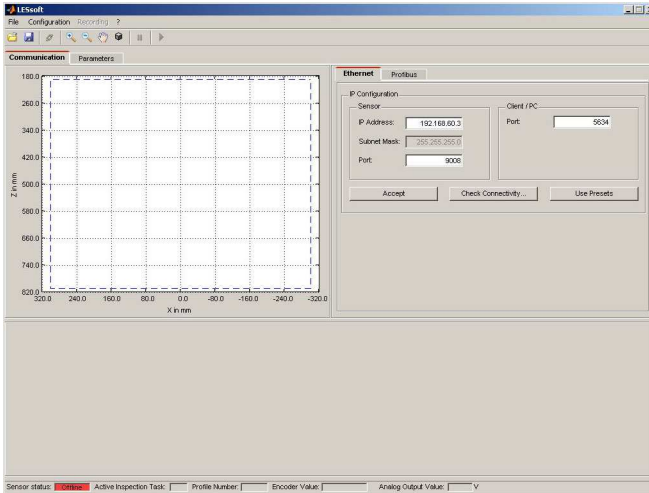


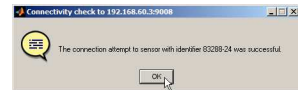
Figure 9.1: Initial screen LESsoft

☞ In the IP Configuration area, enter the settings for the LES and click on Accept.

You had already determined this data in chapter 8.2.

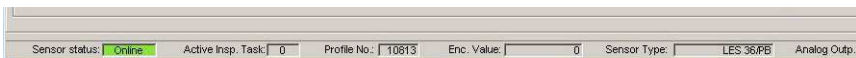
☞ Click on Check Connectivity to test the connection to the LES.

If the following message appears, the Ethernet connection to the LES is correctly configured: The connection attempt to sensor ... was successful.



Click on the button Connect to sensor: 

As a result **LESsoft** establishes a connection and displays the currently measured 2D profile. In the status line at the bottom left of the display you will now find **Online** highlighted in green instead of **Offline** highlighted in red.



**Notice!**

The following additional information is displayed in the status line:

- Sensor connection status (Sensor status)
- Number of the Active Inspection Task
- Scan number (Profile Number)
- Encoder value dependent on the sensor type (Encoder Value)
- Connected sensor type
- Analog output status (Analog Output)

**Notice!**

Once the LESsoft has established a connection to the LES, the laser beam flashes.

PROFIBUS settings (only LES 36/PB and LES 36HI/PB)

For PROFIBUS devices, you can set the slave address and the baud rate in the PROFIBUS tab.

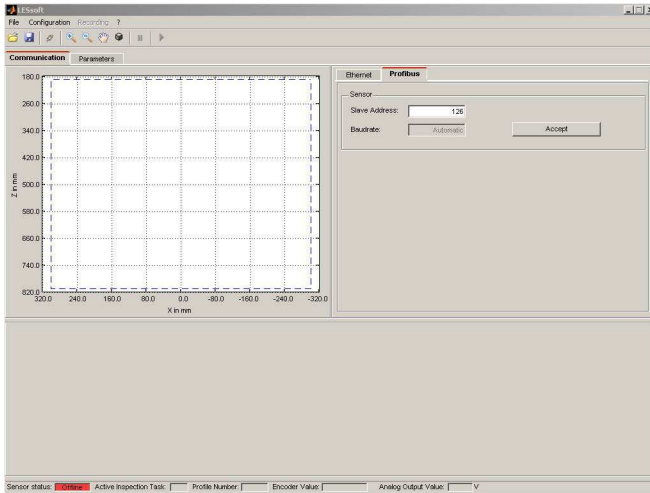


Figure 9.2: PROFIBUS settings

Automatic detection of the baud rate / automatic address assignment

The LES 36.../PB supports automatic detection of the baud rate and automatic address assignment via the PROFIBUS.

The address of the PROFIBUS participant can be set automatically by the commissioning tool of the PROFIBUS system (a class 2 PROFIBUS master). For this purpose, the slave address must be set to value **126** in the sensor (factory setting). This is performed by means of LESsoft or via the display.

The commissioning master checks whether a slave has address **126** and then assigns this slave a slave address smaller than 126. This address is permanently stored in the participant. The changed address can then be queried (and, if necessary, changed again) via the display or LESsoft.

The following baud rates can be set:

- Automatic
- 19.2kBaud
- 93.75kBaud
- 500kBaud
- 3MBaud
- 9.6kBaud
- 45.45kBaud
- 187.5kBaud
- 1.5MBaud
- 6MBaud



Notice!

After changing the PROFIBUS slave address via the display or LESsoft, a power-on reset must be performed in order to permanently accept the address. For the changed settings to take effect, they must be transferred to the sensor!

9.4 Parameter settings/Parameters tab

Click on the **Parameters** tab to access the parameter settings:

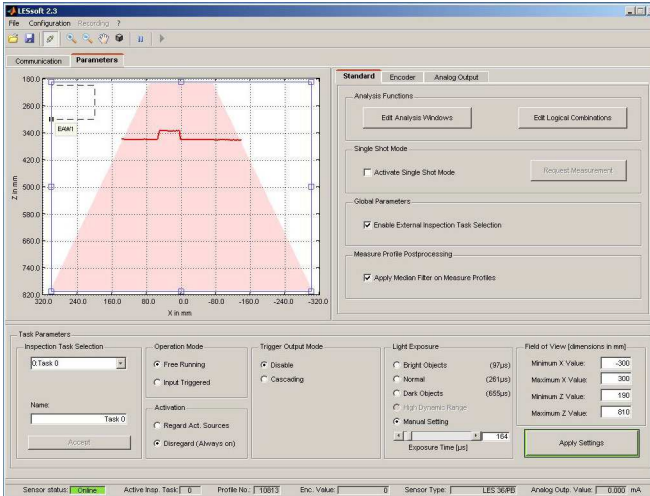


Figure 9.3: Parameter settings LESsoft

The LES is adapted to applications in the **Parameters** tab (**Standard** tab). First go to the **Task Parameters** panel and set the values required for operating the LES. Then go to the **Analysis Functions** panel and define analysis windows (EAWs, AWs) for edge and object detection.

Finally, save these settings as an **Inspection Task** by clicking on **Apply Settings** or **Transmit to Sensor**.

The analog output is configured in the **Analog Output** tab (chapter 9.4.5).

9.4.1 Standard tab - Task Parameters panel

Inspection Task Selection

In the `Inspection Task Selection` panel, you can select inspection tasks.



Notice!

*By default, changeover of the inspection tasks via the PROFIBUS master (PLC) has priority over LESsoft. In this field, the selection of the inspection task with LESsoft is only possible if, under `Global Parameters` there is **no tick** in front of `Enable External Inspection Task Selection`. Otherwise, the inspection task can only be selected via the process interface.*

By removing the tick in the `Enable External Inspection Task Selection` check box, the inspection task cannot be changed via the process interface while configuration is being performed. After configuring with LESsoft and before transmitting the settings to the sensor ('`Transmit to Sensor`'), the `Enable External Inspection Task Selection` check box must again be selected. Only then can inspection tasks be selected via the process interface.

The upper drop-down menu `Inspection Task Selection` lets you select one of the 16 possible inspection tasks. After the selection of the inspection task, the associated parameters are loaded and displayed. You can edit these parameters and save the edited parameters under the same name.

In the `Name` field, you can assign a meaningful name (max. 12 characters) to the inspection task selected above and save it by clicking on `Accept`.

By saving via the button `Apply Settings`, **the currently displayed** inspection task is temporarily stored in the sensor. When switched off, the data/settings are lost.

By saving via `Configuration -> Transmit to Sensor` menu command **all inspection tasks created** are transmitted to the sensor, where they are permanently stored.



Notice!

If an inspection task was changed, permanent storage in the sensor should be performed with `Configuration -> Transmit to Sensor`.

The common procedure for creating and storing inspection tasks is described in chapter 9.6, "Definition of inspection tasks" on page 92 .

Operation Mode

In `Operation Mode` you can configure using `Free Running` that the LES continuously detects and outputs measurement data (factory setting). With `Input Triggered` the LES captures measurement data only if a rising edge is present at the trigger input or if one of the "Ethernet Trigger" (chapter 10.3.4) or PROFIBUS Trigger (chapter 11.5) commands is being used. Detailed information on this topic can be found in chapter 4.2.3.

Activation

Under **Activation** the **Regard** setting has the effect that the laser is switched on and off according to the level at the activation input or via PROFIBUS. Detailed information on this topic can be found in chapter 4.2.2.

When the **Disregard** setting has been selected, the laser always remains switched on, independent from the level at the activation input or the PROFIBUS activation (factory setting).

Trigger Output Mode

Under **Trigger Output Mode** you can activate the cascading output using **Cascading**. Detailed information on this topic can be found in chapter 4.2.4. When the **Disable** setting has been selected, the cascading output will not be set (factory setting).

Light Exposure

Using **Light Exposure** you can control the exposure duration of the laser during measurement value detection and adapt it to the reflective properties of the objects to be detected.

- ☞ *Select an exposure setting that displays a continuous line around the object contour. Then try to achieve a line on a flat surface that is as continuous as possible.*

Field of View

Using **Field of View** you can restrict the measurement range of the LPS. The same happens if you click on the square handles of the measurement range framed in blue with the mouse and then pull.

Factory settings for **Field of View**:

	LES 36...	LES 36HI...
Min X	-300	-70
Max X	300	70
Min. Y	190	190
Max Y	810	610

- ☞ *By restricting to the necessary detection range, ambient light or undesired reflections can be suppressed.*

Apply Settings

The **Apply Settings** button temporarily transmits the settings for the current inspection task to the sensor. When switched off, the data/settings are lost.



Notice!

If an inspection task was changed, permanent storage in the sensor should be performed with Configuration -> Transmit to Sensor.

9.4.2 Standard tab - Analysis Functions panel

In the Analysis Functions panel, the primary settings of the LES for realizing applications are made.

Edit Analysis Windows

In the Analysis Functions panel, use the Edit Analysis Windows button to define the rectangular analysis windows. You can define up to four edge analysis windows (EAW - Edge Analysis Window) and up to four normal analysis windows (AW - Analysis Window).



Notice!

EAWs are used for edge detection; they can also be used for object detection. In AWs, only object detection is possible. How evaluation of the measurements functions with EAWs and AWs is described in chapter 4.3 and chapter 4.4.

Click the Edit Analysis Windows button to open the table for defining the analysis windows.

Dimensions and chaining								Edge Detection Definitions					Analysis Window Definitions					
Analysis Window	Position type	Relative to Edge	Offset X	Offset Z	Min. X	Max. X /Width	Min. Z	Max. Z /Height	Current Status	Active	Sequent Hits	Current Sequent Hits Left	Current Sequent Hits Right	Current Status	Active	Hits On	Hits Off	Current Hits
EAW1	absolute		0	0	-87	73	265	315		<input checked="" type="checkbox"/>	5	168	168		<input type="checkbox"/>	20	10	
EAW2	absolute		0	0	200	300	200	300		<input type="checkbox"/>	5				<input type="checkbox"/>	20	10	
EAW3	absolute		0	0	200	300	200	300		<input type="checkbox"/>	5				<input type="checkbox"/>	20	10	
EAW4	absolute		0	0	200	300	200	300		<input type="checkbox"/>	5				<input type="checkbox"/>	20	10	
AW05	absolute				200	300	200	300							<input type="checkbox"/>	20	10	
AW06	absolute				200	300	200	300							<input type="checkbox"/>	20	10	
AW07	absolute				200	300	200	300							<input type="checkbox"/>	20	10	
AW08	absolute				200	300	200	300							<input type="checkbox"/>	20	10	

Notice!

After changing the detection range by dragging the black frame with the mouse, click the **button Accept Analysis Window Rectangle** so that the new values are accepted.

If you click somewhere else in the Edge Analysis Window Definitions window, the values prior to changing the detection range by mouse are restored.

Notice!

After you have defined the size and position of an analysis window, the settings must be transmitted to the sensor. To do so, click the **Apply Settings button**.

If the settings are to be saved permanently in the sensor, you must also execute the command **Transmit to Sensor** in the Configuration menu.

Dimensions and chaining								Edge Detection Definitions					Analysis Window Definitions					
Analysis Window	Position type	Relative to Edge	Offset X	Offset Z	Min. X	Max. X /Width	Min. Z	Max. Z /Height	Current Status	Active	Sequent Hits	Current Sequent Hits Left	Current Sequent Hits Right	Current Status	Active	Hits On	Hits Off	Current Hits
EAW1	absolute		0	0	47	73	265	315		<input checked="" type="checkbox"/>	5	168	168		<input type="checkbox"/>	20	10	
EAW2	rel.-EAW1	Rightmost %Z	-30	-20	200	50	200	100		<input checked="" type="checkbox"/>	5	74	74		<input type="checkbox"/>	20	10	
EAW3	absolute		0	0	200	300	200	300		<input type="checkbox"/>	5				<input type="checkbox"/>	20	10	
EAW4	absolute		0	0	200	300	200	300		<input type="checkbox"/>	5				<input type="checkbox"/>	20	10	
AW05	absolute				200	300	200	300							<input type="checkbox"/>	20	10	
AW06	absolute				200	300	200	300							<input type="checkbox"/>	20	10	
AW07	absolute				200	300	200	300							<input type="checkbox"/>	20	10	
AW08	absolute				200	300	200	300							<input type="checkbox"/>	20	10	

Figure 9.4: Edit Analysis Windows

Alternatively, the spatial position and size of EAWs and AWs can be configured with the mouse or by means of keyboard entries. After selecting the `Active` check box (by clicking), a black frame with handles appears at the left in the display of the detection area. You can now use the mouse or keyboard to position the analysis window.

Using the mouse

Click and drag the handles of the analysis window using the mouse to change its size and position.



Notice!

The font of the `Accept Analysis Window Rectangle` button turns black after size and/or position of the analysis window have been changed using the mouse. You have to click the button in order to accept the values in the 2D representation.

Keyboard input

Alternatively, you can enter the desired position values directly into the Minimum/Maximum X/Z columns under Dimensions.



Notice!

The changed settings must be transferred to the sensor with `Apply Settings`.

Position type

Here you determine whether the coordinates of an analysis window are to be absolute, or whether the position of an EAW is to change relative to a found edge.

The first analysis window provides the reference and must therefore be configured with absolute coordinates. The other analysis windows can be defined relative to an edge in one of the previous EAWs.

Relative to Edge

Here you select the reference edge (e.g. within EAW1) for relative tracking of EAW2. Possible settings are:

- Tracking in X-direction: Rightmost X, Leftmost X
- Tracking in Z-direction: Rightmost Z, Leftmost Z
- Simultaneous tracking in X and Z-direction: Rightmost XZ, Leftmost XZ

Offset X / Offset Z

If you have selected relative tracking for an analysis window, you can define the offset of the X and Z-position relative to the reference edge.

You define the window width / height with `Width / Height`. The values `Min X`, `Max X`, `Min Z`, `Max Z` are ignored in this case.

Edge Detection Definitions

Here, you define the parameters for edge detection in up to four EAWs. Select the check box in the `Active` column to activate the respective EAW.

For the edge plausibility check, the `Sequent Hits` parameter determines the minimum number of successive measurement points (see chapter 4.3.3). For orientation as to how

the `Sequent Hits` parameter is to be selected, the currently measured number of successive object points in the EAW is shown in the `Current Sequent Hits Left` and `Current Sequent Hits Right` columns.

An edge is detected if `Current Sequent Hits Left` or `Current Sequent Hits Right` is greater than or equal to `Sequent Hits`. In this case, the status of the EAW in the `Current Status` column is green (ok). If an edge is detected, the status of the EAW in the `Current Status` column is red (not ok). If the EAW is not activated, the status is gray.

If not enough measurement points occurred in succession in an EAW, edge detection and object measurement within this EAW is not possible.

Analysis Window Definitions

Here, you define the parameters for object detection in up to four EAWs and four AWs. Select the check box in the `Active` column to activate object detection in the respective analysis window. The optionally selectable object detection enables stable measurement results even under problematic conditions.

In the `Current Hits` column, LESsoft displays the number of measurement points that are detected in the analysis window. In the `Hits On` column, you define how many measurement points must be detected in order for the evaluation result of the object detection to be **ok** in the respective analysis window. If the result is **ok**, a green dot is displayed in the `Current Status` column. The state remains green until the number of detected hit points becomes equal to or smaller than the value you set in the `Hits Off` column.

The entries in `Hits On` and `Hits Off` thus let you configure a switching hysteresis to prevent an (unwanted) change of the switching state under admissible changes in the object position or other physical quantities.

The further processing and combination of results from object detection occurs by pressing the `Edit Logical Combinations` button.



Notice!

The changed settings must be transferred to the sensor with `Apply Settings`.

Edit Logical Combinations

By clicking on the **Edit Logical Combinations** button, the following window appears.

Edge Status	Edge1 (EAW1)		Edge2 (EAW2)		Edge3 (EAW3)		Edge4 (EAW4)	
	Left Most	Right Most	Left Most	Right Most	Left Most	Right Most	Left Most	Right Most
Object Point / EAW Status								
Show Edge	<input checked="" type="checkbox"/>	<input checked="" type="checkbox"/>	<input checked="" type="checkbox"/>	<input type="checkbox"/>	<input type="checkbox"/>	<input type="checkbox"/>	<input type="checkbox"/>	<input type="checkbox"/>
X	72.4	23.3						
Width (X)	49.1							
Z	339.2	340.5						
Height (Z)	1.3							
Profibus Inputs 1	LX		LX		LX		LX	
Profibus Inputs 2	LX		LX		LX		LX	
AW Logic Analysis Depth	Logic		Logic		Logic		Logic	
Analysis Depth	1		1		1		1	
AW Logic	&		&		&		&	
EAW1	+							
EAW2								
EAW3								
EAW4								
AW05								
AW06								
AW07								
AW08								

Figure 9.5: 'Edge Analysis Window Combination Tables' window

Edge State (result of edge and object detection)

The AND combination result of the Object Point/EAW State (edge detection state) line and the AW Logic Analysis Depth (state of the logic for object detection) line are displayed here for each EAW.

If no object detection was configured, the Edge State corresponds to the status of edge detection.

- Green state = edge detection and object detection **ok**
- Red state = edge detection and object detection **not ok**



Notice!

For sensors with analog output, a valid measurement value transmission for edges only occurs at the analog output if the Edge State is ok.

Object Point/EAW State (result of edge detection)

For each EAW, the result of the edge plausibility check is displayed here for the left edge (Left Most) and right edge (Right Most).

- Green state = edge detected = **ok**
- Red state = no edge detected = **not ok**

The result is identical to the status under Edit Analysis Windows -> Edge Detection Definitions.



Notice!

A valid measurement value transmission for edges only occurs if the Object Point/EAW State is **ok**.

Show Edge

If the check box is selected, the **left** edge position is displayed in the 2D view with a **green coordinate cross**, the **right** edge position with a **blue coordinate cross**.

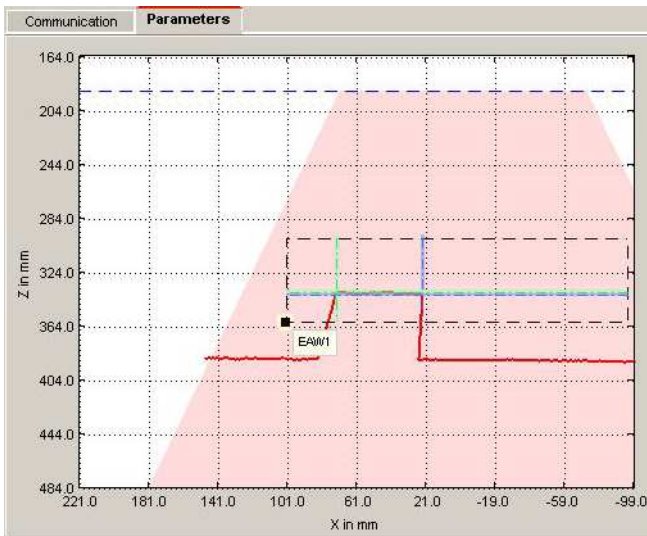


Figure 9.6: Display of the edge positions (green and blue) in the 2D display

X, Width (X), Z, Height (Z)

In the fields of these lines, the current measurement values **LX**, **RX**, **LZ**, **RZ**, **W** and **H** are displayed for each EAW in mm (see chapter 4.3.3), provided the EAW was defined.

Measurement values and their meaning:

- Edge positions: LX, LZ, RX, RZ
 - LX = Left edge X-coordinate
 - LZ = Left edge Z-coordinate
 - RX = Right edge X-coordinate
 - RZ = Right edge Z-coordinate.
- Width of objects: W (calculated from the distance of RX and LX in the X direction).
- Height difference of left and right edge: H (calculated from the distance of RZ and LZ in the Z-direction).

Profibus Inputs 1 , Profibus Inputs 2

The selection of which process values are transmitted via PROFIBUS is made here. With PROFIBUS devices, two measurement values (LX, RX, LZ, RZ, W or H; see chapter 4.3.3) can be output per EAW via the PROFIBUS. In the `Profibus Inputs 1` and `Profibus Inputs 2` fields, you can configure which measurement values these are for up to four edge analyses.

**Notice!**

The changed settings must be transferred to the sensor with `Apply Settings`.

Application example 1: web edge measurement

In the following example, the right edge position of web material is to be ascertained. Edge analysis window EAW1 is positioned in the measurement range so that the web material is located within the window.

The ascertained position of the right edge is -9.6mm (column Edge1 -> Right Most -> line X). The distance from the edge to the sensor is 366.6mm (column Edge1 -> Right Most -> line Z).

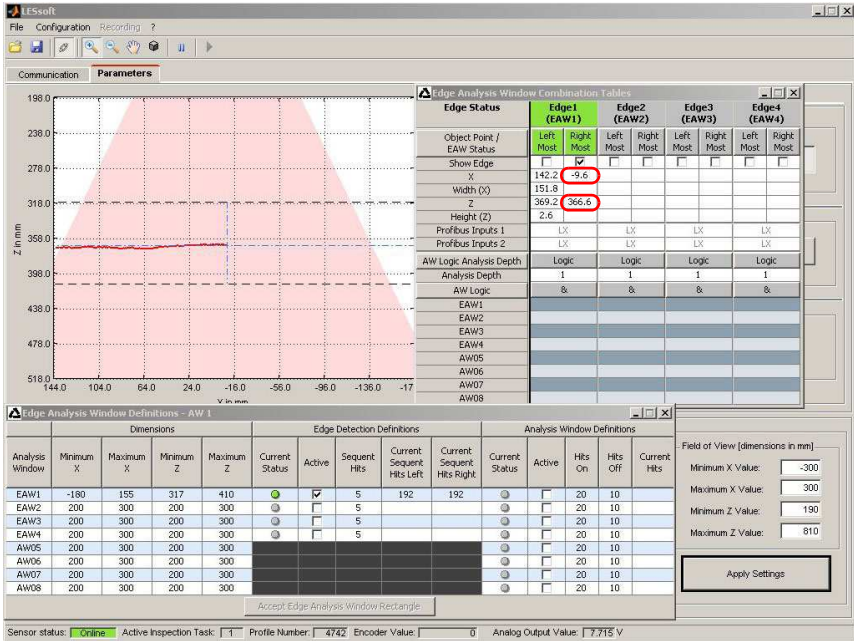


Figure 9.7: Application example 1: web edge measurement

Application example 2: height and width monitoring of cubic objects

In the following example, the height and width of a carton are measured. For the width measurement, EAW1 is positioned above the support surface. For the height measurement, EAW2 is positioned to the side of the carton. The height of EAW2 is configured so that both the support surface as well as the top side of the carton are located in EAW2.

The ascertained width of the carton is 49.7mm (column Edge1 -> line width (X)). The ascertained height is 49.6mm (column Edge2 -> line Height (Z)).

All measurement results are displayed in the window to the right of the 2D view.

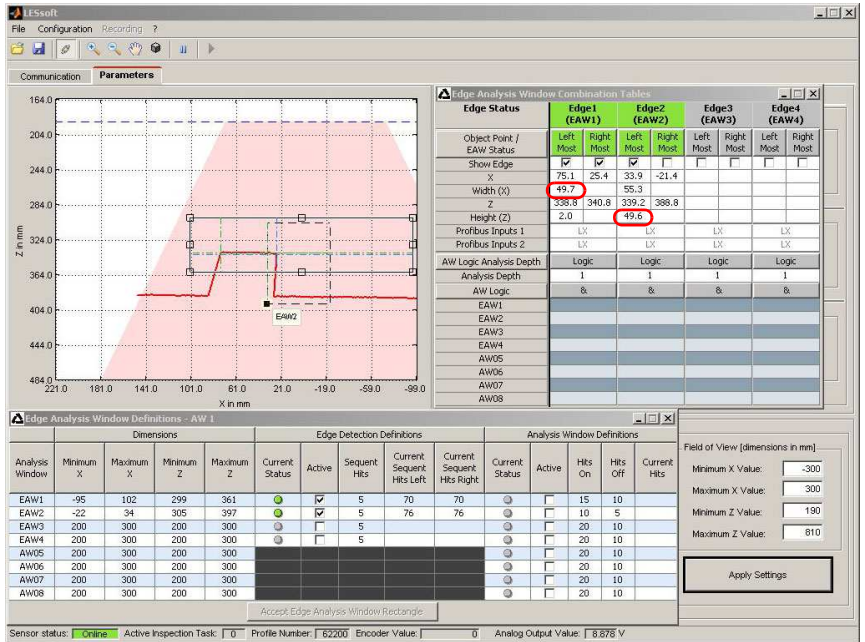


Figure 9.8: Application example 2: height and width monitoring of cubic objects

Additional object detection with LES sensors

In the lower part of the Edge Analysis Window Combination Tables window (see figure 9.5), an additional object detection can be configured.



Notice!

Object detection is only possible if object detection was activated in the EAW/AW. This is performed in LESsoft by selecting the check box in the Active column under Edit Analysis Windows -> Analysis Window Definitions.

EAW1 ... EAW4, AW05 ... AW08

Specify here which analysis windows are to be logically AND linked with one another with respect to the analysis of the Current Hits . With the "+" selection, the (E)AW state is taken into account in the AND combination. If "-" is selected, the inverse of the (E)AW state is taken into account.

The result of the logic combination is displayed in the AW Logic line.



Notice!

An entry is only possible if object detection was activated in the EAW/AW.

AW Logic

The status display of the AND combination result of EAW1 ... EAW4, AW05 ... AW08 is shown here:

- Green state = **ok**
- Red state = **not ok**



Notice!

A display appears only if object detection was activated in an EAW/AW.

Analysis Depth

The analysis depth is entered here. The analysis depth is the number of successive evaluations with the same result that are necessary for a change of the combination result (value range: 1 ... 255).



Notice!

A display appears only if object detection was activated in an EAW/AW.



Notice!

Select a larger value for the analysis depth to give the LES a reliable switching behavior. The response time of the sensor during object detection increases accordingly (example: analysis depth = 3 -> response time 3 x 10ms = 30ms). Interfering signals of individual scans are suppressed. If an analysis depth = 1 (factory setting beginning with firmware version 01.25) is selected, the response time is 10ms.

AW Logic Analysis Depth (result of object detection)

The status display of the combination result of `AW Logic` appears here, taking into account the analysis depth.

- Green state = **ok**
- Red state = **not ok**

***Notice!***

A display appears only if object detection was activated in an EAW/AW.

***Notice!***

The changed settings must be transferred to the sensor with `Apply Settings`.

Application example 3: width monitoring of cubic objects with object detection (narrow objects are not to be detected)

The application example is similar to application example 2. The width of cartons is to be measured. For narrow objects, the measurement is to be suppressed. For width measurement, EAW1 is to be positioned above the support surface as in application example 2. In addition, object detection is configured in the Edit Analysis Windows window -> Analysis Window Definitions.



Notice!

Object detection is only possible if object detection was activated in the EAW/AW. This is performed in LESSoft by selecting the check box in the Active column under Edit Analysis Windows -> Analysis Window Definitions.

The threshold for object detection in EAW1 is 60 hits. In figure 9.9 there is a wide object with Current Hits = 68 in the measurement range of the LES. The object is detected, the state of object detection is green (ok). In the Edge Analysis Window Combination Tables window, the additional object detection is activated by selecting + under EAW1. All results are green (ok). The ascertained width of the carton is 49.2mm (column Edge1 -> line Width (X)).



Figure 9.9: Application example 3.1: width monitoring of cubic objects with object detection

In figure 9.10 there is a narrow object with Current Hits = 20 in the measurement range of the LES. The object is considered to be not detected, the state of object detection in the Edge Analysis Window Definitions window -> Analysis Window Definitions is red (**not ok**).

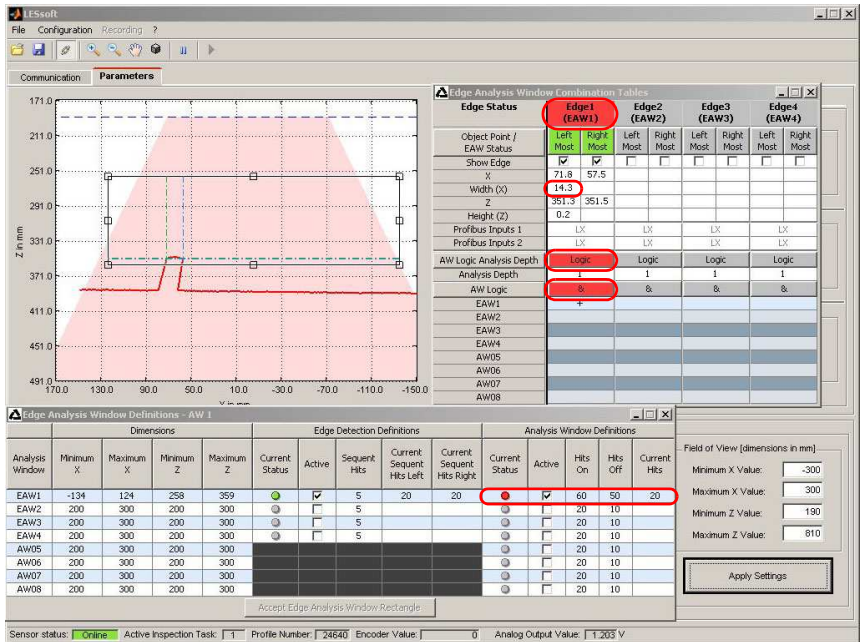


Figure 9.10: Application example 3.2: width monitoring of cubic objects with object detection

In the Edge Analysis Window Combination Tables window, the additional object detection is activated by selecting + under EAW1. The result for object detection is **not ok** (red state). The Edge State (AND combination of the results of edge and object detection) is displayed red (**not ok**). The ascertained width of the object is 14.2mm (column Edge1 -> line Width (X)).



Notice!

For sensors with **analog output**, a valid measurement value transmission for edges only occurs at the analog output if the Edge Status is **ok** (see page 79).
 In the case of sensors with **digital switching outputs** at X3 (LES 36/VC6, LES 36 HI/VC6), the status of Edge 1 to 4 is signaled at outputs Out1 to Out4 (HIGH active).

9.4.3 Standard tab - Single Shot Mode panel

In Single Shot Mode, the sensor carries out an individual analysis only when you click on the Request Measurement button and displays the result in **LESsoft** until Request Measurement is clicked again.

9.4.4 Standard tab - Global Parameters panel

Under Global Parameters you can use Enable External Inspection Task Selection to configure whether or not the inspection tasks 0 ... 15 can be selected via PROFIBUS.



Notice!

If Enable External Inspection Task Selection is ticked, the inspection task can only be selected via PROFIBUS. In this case, the drop-down menu under Inspection Task Selection has no function.

9.4.5 Analog Output tab - configuring the analog output (only LES 36.../VC)

For analog devices, you can configure the analog voltage and current output of the LES 36.../VC6 in the Analog Output tab.

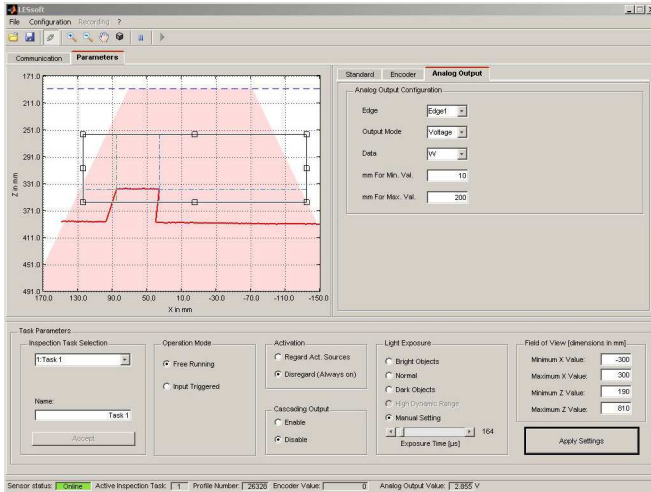


Figure 9.11: Parameter settings in LRSsoft

The following settings can be made for the analog output:

Edge

Selection of from which EAW (Edge Analysis Window) the measurement value is to be transmitted.

Output Mode

Selection of whether the current or voltage output is to be used as the process interface.

Data

Selection of which value of the selected EAW is to be output at the analog output. Select from the following measurement values:

- Edge positions: **LX, LZ, RX, RZ**
 - **LX** = Left edge X-coordinate
 - **LZ** = Left edge Z-coordinate
 - **RX** = Right edge X-coordinate
 - **RZ** = Right edge Z-coordinate
- Width of objects: **W**
- Height difference of left and right edge: **H**

**Notice!**

The selected value is appears in the measurement value display of the display (2nd line) in the middle.

mm For Min. Val.

Measurement value in mm for the **lower** range limit of the voltage or current (1V/4mA).

mm For Max. Val.

Measurement value in mm for the **upper** range limit of the voltage or current output (10V/20mA).

**Notice!**

The minimum adjustable range between the upper and lower range limit of the analog output is 10mm.

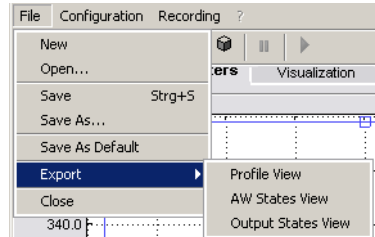
**Notice!**

The changed settings must be transferred to the sensor with `Apply Settings`.

9.5 Menu commands

9.5.1 Saving parameter settings/File menu

The **File** menu is used to save parameter data to the PC. In this way, settings for various detection tasks can be defined within the scope of commissioning and stored on data carriers and parameter files. During operation, the LES is reconfigured via **Inspection Tasks**. A parameter file stored on a data carrier can only be used with LESSoft configuration software!



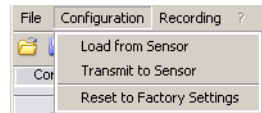
- **New** creates a new configuration file.
- **Open** opens a configuration file from the data carrier.
- **Save** saves the open configuration file with the same name.
- **Save as** saves the open configuration file under a different name.
- **Save as default** saves the open configuration as the default setting which is always loaded when LESSoft is opened.

In addition, the **File** menu offers the possibility to export the following views format to data carriers (available formats: *.png, *.jpg, *.bmp, *.tif):

- **Profile View**: the current view as 2D view.

9.5.2 Transmitting parameter settings/Configuration menu

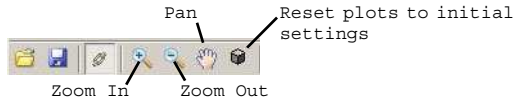
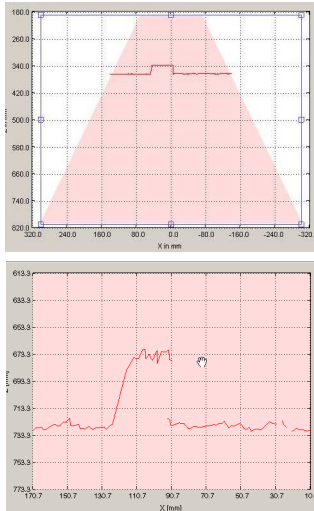
The **Configuration** menu is used to exchange parameter data with the connected LES.



- **Load from Sensor** loads all parameter settings for all defined inspection tasks from the LES and displays them in the software.
- **Transmit to Sensor** permanently stores all parameter settings of all defined inspection tasks from the configuration software in the LES.
- **Reset to factory settings** resets the LES to factory settings.

9.5.3 Zoom and Pan/toolbar

The Zoom in / Zoom out and Pan buttons of the toolbar allow individual areas of the view to be enlarged for better visual evaluation:



Enlarge area:

1. Select Zoom in
2. Click in the view
3. Select Pan
4. Shift the area to be examined into the center of the screen

↻ Repeat until the desired view is reached

↻ Use Reset plots to initial settings to restore the original size.

Figure 9.12: Zoom function

After activating the magnifying glass, each click on the view enlarges the displayed section. The enlarged section can then be shifted with the activated hand function to display the area of interest.





Notice!

The click-and-drag method for zooming known from other programs is not possible here. Before LPSsoft is operated further, the tool buttons (Zoom, Pan, ...) must be activated.

9.6 Definition of inspection tasks

Typical procedure

1. Start LESsoft and connect the sensor:
Click on the Connect to sensor button: .
2. Fetch the configuration from the sensor via Load from Sensor or load it from the data carrier with Open.
3. Remove the tick at Enable Selection Inputs.
4. Use Inspection Task Selection to select the inspection task to be modified.
5. Display and, if necessary, enlarge 2D view of the detection range in the Parameters tab.
6. Standard tab - Task Parameters panel: define required (E)AWs with mouse or keyboard in the Analysis Windows Definitions window (Edit Analysis Windows but-

- ton); confirm each of the set (E)AWs with `Apply Settings`.
- Configure the `Sequent Hits` limit value for the edge plausibility check for each EAW.
7. Configure PROFIBUS process data in the `Edge Analysis Window Combination Tables` window (`Edit Logical Combinations` button) in lines `Profibus Inputs 1` and `Profibus Inputs 2`, or, alternatively, configure the analog output via the `Analog Output` tab.
 8. Check the process reliability in the `Edge Analysis Window Combination Tables` window and in the 2D view.
 9. Assign a name (`Name`) to the inspection task and confirm with `Accept`.
 10. Temporarily transfer the inspection task with `Apply Settings`.
 11. Where applicable: define further inspection tasks with steps 5.-9.
 12. Tick `Enable Selection Inputs` again.
 13. Permanently transfer the configuration including all inspection tasks to the sensor with `Transmit to Sensor`.
 14. Where applicable: save the configuration to data carrier with `Save As...`
 15. Finally, disconnect the connection to the sensor:
click on the button `Disconnect from sensor`: 

10 Integrating the LES in the process control

10.1 General information

The LES communicates with the process control via UDP/IP using the protocol described in chapter 10.2.9. The protocol operates in two different modes:

- Measure mode
- Command Mode

In measure mode, the LES transmits the evaluation telegram. This is continuously transmitted in "Free Running" operation; in triggered operation, it is transmitted only once per trigger.

In command mode the LES reacts to commands from the control. The commands available are described in chapter 10.2.9.



Notice!

If you use a firewall, please make certain that the control can communicate with the LES via the Ethernet interface by means of UDP on ports 9008 and 5634 (these ports are preset at the factory, but may have been changed by the user, see chapter 7.2 "Menu description"). Furthermore, the firewall must allow ICMP echo messages to pass through for the connection test (ping).

The integration of PROFIBUS device model LES 36.../PB in the process control via PROFIBUS is described in chapter 11 "Integration of the LES 36.../PB in the PROFIBUS" on page 111.

10.2 Protocol structure: Ethernet



Notice!

The sequence in which the individual bytes are saved varies depending on the operating system. The commands in chapter 10.2.9 and the protocol description are represented in "big endian" format, i.e., the high-byte first followed by the low-byte (0x... hexadecimal).

Windows PCs (and many controls, such as the Siemens S7), however, store data in the "little endian" format, i.e. the low byte first followed by the high byte.

⚠ If, in your process environment, the LES does not respond to commands from the control even though communication with LESsoft functions properly, check whether the problem lies with the byte order.

Example: for command 0x434E (Connect to Sensor) a Windows PC must transmit 0x4E and 0x43 in order for it to be understood by the LES. In the transaction number of the answer from LES there is then also 0x4E43 (byte sequence 0x43, 0x4E). The LES sends data as "little endian", i.e., first the low byte and then the high byte.

The possible values of individual bytes and their meaning are described below.

Protocol structure

The protocol consists of the **header** (30 bytes) followed by the **user data** (0 ... 75 data words @ 2 bytes). The protocol is used both in command mode when transmitting commands and when acknowledging sensor commands as well as in measure mode.

Header

Startseq. 1	Startseq. 2	Fill character	Command no.	Fill character	Packet no.	Fill character	Transaction no.	Status	Encoder H	Encoder L	Fill character	Scan no.	Type	Number of user data words
0xFFFF	0xFFFF	0x0000	0x0059	0x0000	0x0000	0x0000	0x0000	0x0000	0x0000	0x0000	0x0000	0x0000	0x0010	0x0003
Length 4 bytes, fixed value: 0xFFFF 0xFFFF		Length 2 bytes, fixed value: 0x0000	Length 2 bytes, possible values: see chapter 10.2.9	Length 2 bytes, fixed value: 0x0000	Length 2 bytes, value range: 0x0000 ... 0xFFFF	Length 2 bytes, fixed value: 0x0000	Length 2 bytes, value range: 0x0000 ... 0xFFFF	Length 2 bytes, value range: 0x0000 ... 0xFFFF	Length 4 bytes, value range: 0x0000 0000 ... 0xFFFF FFFF 1)		Length 2 bytes, fixed value: 0x0000	Length 2 bytes, value range: 0x0000 ... 0xFFFF	Length 2 bytes, fixed value: 0x0010	Length 2 bytes, possible values: 0x0000 / 0x0001 / 0x0002 / 0x0003 / 0x0178

Length of the header: 30 bytes

1) For sensor models with encoder input, these 4 bytes contain the encoder value. With the LES, this value is always 0x0000 0000.

10.2.1 Command number

The command number specifies both the command from the control to the sensor as well as the command from the sensor to the control (see chapter 10.2.9).

In **measure mode**, the sensor always sends an evaluation telegram with command number 0x5354.

10.2.2 Packet number

The packet number serves internal maintenance purposes of the manufacturer.

10.2.3 Transaction number

In **measure mode**, 0x0000 is always displayed here.

In **command mode**, the command acknowledgment of the sensor contains the command number of the command that is answered.

10.2.4 Status

Indicates the state of the sensor. The state is coded as follows:

MSB	High-Byte				LSB	MSB	Low-Byte				LSB	Meaning of the bits		
-	-	-	-	-	-	-	-	-	-	-	-	-	0	Sensor not connected via Ethernet
-	-	-	-	-	-	-	-	-	-	-	-	-	1	Sensor connected via Ethernet
-	-	-	-	-	-	-	-	0	0	0	1	-	-	Measure mode
-	-	-	-	-	-	-	-	0	0	1	0	-	-	Menu mode
-	-	-	-	-	-	-	-	0	1	0	0	-	-	Command mode
-	-	-	-	-	-	-	-	1	0	0	0	-	-	Error mode
-	-	-	-	-	-	-	0	-	-	-	-	-	-	Sensor deactivated via activation function
-	-	-	-	-	-	-	1	-	-	-	-	-	-	Sensor activated via activation function
-	-	-	-	-	-	0	-	-	-	-	-	-	-	No warning
-	-	-	-	-	-	1	-	-	-	-	-	-	-	Warning, temporary sensor malfunction
-	-	-	-	-	0	-	-	-	-	-	-	-	-	Free Running measure mode
-	-	-	-	-	1	-	-	-	-	-	-	-	-	Triggered measure mode
-	-	-	-	0	-	-	-	-	-	-	-	-	-	No configuration memory connected
-	-	-	-	1	-	-	-	-	-	-	-	-	-	Configuration memory connected
-	-	0	-	-	-	-	-	-	-	-	-	-	-	No error
-	-	1	-	-	-	-	-	-	-	-	-	-	-	Error detected, measurement data are still sent if applicable, the sensor then switches into error mode

The LSB of the high byte is always set to 1 as long as the parameter `Activation Input` has been set to `Disregard (Always on)` in **LESsoft**.

If parameter `Activation Input` is set to `Resard`, the state of the bit corresponds to the state of the signal of an activation source (input, Ethernet activation).



Notice!

Independent of the mode that is currently active, the sensor switches to menu mode if a button on the display is touched and then neither responds to commands nor does it transmit measurement data. Menu mode automatically ends after 3 minutes if no buttons are pressed. Alternatively, the user can end menu mode with the Exit menu item.

10.2.5 Encoder High / Low

The encoder counter is implemented in sensor models with encoder input. All other sensors permanently display 0x00000000.

The 4 bytes in **Encoder High** and **Encoder Low** specify the encoder counter value for light section sensors with encoder interface. The maximum value is 0xFFFF FFFF. Beyond that an overflow to 0x0000 0000 occurs.

10.2.6 Scan number

The **2 bytes** of the **scan number** indicate the number of single measurements in chronological order. After each measured profile, this number increases by 1. The maximum value is 0xFFFF. Beyond that an overflow to 0x0000 occurs. The Z- and X-data belonging to a measurement are identified via the same scan number.

10.2.7 Type

Specifies how the detection data are to be interpreted. The fixed default value is 0x0010.

10.2.8 Number of user data

The user data have a variable length of 0, 1, 2, 3 or 75 data words (0, 2, 4, 6 or 150 bytes). Indicates the number of user data transferred. The fixed default value in detection mode is 0x0059.

10.2.9 Evaluation telegram

In detection mode for the LES, the evaluation telegram is transmitted with command number 0x5354. After the header are 75 user data words with the following structure:

Byte	MSB								High-Byte				LSB				MSB			Low-Byte			LSB			Meaning of the bits									
31...32	-	-	-	-	-	-	-	-	-	-	-	-	-	-	-	-	-	-	-	-	-	N4	N3	N2	N1	Number of the current inspection task									
33...34	-	-	-	-	-	-	-	-	-	-	-	-	-	-	-	-	-	-	-	-	-	AW7	AW6	AW5	EAW4	EAW3	EAW2	EAW1	Results of the individual analysis windows						
35...36	-	-	-	-	-	-	-	-	-	-	-	-	-	-	-	-	-	-	-	-	-	A9	A8	A7	A6	A5	A4	A3	A2	A1	Current number of measurement points (Current Hits) in EAW1				
37...38	-	-	-	-	-	-	-	-	-	-	-	-	-	-	-	-	-	-	-	-	-	A9	A8	A7	A6	A5	A4	A3	A2	A1	Current number of measurement points (Current Hits) in EAW2				
39...40	-	-	-	-	-	-	-	-	-	-	-	-	-	-	-	-	-	-	-	-	-	A9	A8	A7	A6	A5	A4	A3	A2	A1	Current number of measurement points (Current Hits) in EAW3				
41...42	-	-	-	-	-	-	-	-	-	-	-	-	-	-	-	-	-	-	-	-	-	A9	A8	A7	A6	A5	A4	A3	A2	A1	Current number of measurement points (Current Hits) in EAW4				
43...44	-	-	-	-	-	-	-	-	-	-	-	-	-	-	-	-	-	-	-	-	-	A9	A8	A7	A6	A5	A4	A3	A2	A1	Current number of measurement points (Current Hits) in EAW5				
45...46	-	-	-	-	-	-	-	-	-	-	-	-	-	-	-	-	-	-	-	-	-	A9	A8	A7	A6	A5	A4	A3	A2	A1	Current number of measurement points (Current Hits) in EAW6				
47...48	-	-	-	-	-	-	-	-	-	-	-	-	-	-	-	-	-	-	-	-	-	A9	A8	A7	A6	A5	A4	A3	A2	A1	Current number of measurement points (Current Hits) in EAW7				
49...50	-	-	-	-	-	-	-	-	-	-	-	-	-	-	-	-	-	-	-	-	-	A9	A8	A7	A6	A5	A4	A3	A2	A1	Current number of measurement points (Current Hits) in EAW8				
51...52	-	-	-	-	-	-	-	-	-	-	-	-	-	-	-	-	-	-	-	-	-	-	-	-	-	-	-	-	-	-	E4	E3	E2	E1	Results of logic line AW Logic for Edge1 ... Edge4
53...54	-	-	-	-	-	-	-	-	-	-	-	-	-	-	-	-	-	-	-	-	-	-	-	-	-	-	-	-	-	-	E4	E3	E2	E1	Results of logic line AW Logic Analysis Depth for Edge1 ... Edge4
55...56	-	-	-	-	-	-	-	-	-	-	-	-	-	-	-	-	-	-	-	-	-	-	-	-	-	-	-	-	-	-	E4	E3	E2	E1	Results of edge detection in line Object Point/EAW State
57...58	-	-	-	-	-	-	-	-	-	-	-	-	-	-	-	-	-	-	-	-	-	-	-	-	-	-	-	-	-	-	E4	E3	E2	E1	Results of Edge State line (edge and object detection)
59...60	-	-	-	-	-	-	-	-	-	-	-	-	-	-	-	-	-	-	-	-	-	-	-	-	-	-	-	-	-	-	-	-	-	-	Current Sequent Hits Left in EAW1
61...62	-	-	-	-	-	-	-	-	-	-	-	-	-	-	-	-	-	-	-	-	-	-	-	-	-	-	-	-	-	-	-	-	-	-	Current Sequent Hits Right in EAW1
63...64	-	-	-	-	-	-	-	-	-	-	-	-	-	-	-	-	-	-	-	-	-	-	-	-	-	-	-	-	-	-	-	-	-	-	Left edge X-value LX in EAW1
65...66	-	-	-	-	-	-	-	-	-	-	-	-	-	-	-	-	-	-	-	-	-	-	-	-	-	-	-	-	-	-	-	-	-	-	Left edge Z-value LZ in EAW1
67...68	-	-	-	-	-	-	-	-	-	-	-	-	-	-	-	-	-	-	-	-	-	-	-	-	-	-	-	-	-	-	-	-	-	-	Right edge X-value RX in EAW1
69...70	-	-	-	-	-	-	-	-	-	-	-	-	-	-	-	-	-	-	-	-	-	-	-	-	-	-	-	-	-	-	-	-	-	-	Right edge Z-value RZ in EAW1
71...72	-	-	-	-	-	-	-	-	-	-	-	-	-	-	-	-	-	-	-	-	-	-	-	-	-	-	-	-	-	-	-	-	-	-	Width W in EAW1
73...74	-	-	-	-	-	-	-	-	-	-	-	-	-	-	-	-	-	-	-	-	-	-	-	-	-	-	-	-	-	-	-	-	-	-	Height H in EAW1

Byte	MSB	High-Byte	LSB	MSB	Low-Byte	LSB	Meaning of the bits
75...76							Current Sequent Hits Left in EAW2
77...78							Current Sequent Hits Right in EAW2
79...80							Left edge X-value LX in EAW2
81...82							Left edge Z-value LZ in EAW2
83...84							Right edge X-value RX in EAW2
85...86							Right edge Z-value RZ in EAW2
87...88							Width W in EAW2
89...90							Height H in EAW2
91...92							Current Sequent Hits Left in EAW3
93...94							Current Sequent Hits Right in EAW3
95...96							Left edge X-value LX in EAW3
97...98							Left edge Z-value LZ in EAW3
99...100							Right edge X-value RX in EAW3
101...102							Right edge Z-value RZ in EAW3
103...104							Width W in EAW3
105...106							Height H in EAW3
107...108							Current Sequent Hits Left in EAW4
109...110							Current Sequent Hits Right in EAW4
111...112							Left edge X-value LX in EAW4
113...114							Left edge Z-value LZ in EAW4
115...116							Right edge X-value RX in EAW4
117...118							Right edge Z-value RZ in EAW4
119...120							Width W in EAW4
121...122							Height H in EAW4
123...180	-	-	-	-	-	-	The remaining user data are used for internal maintenance purposes of the manufacturer.

10.3 Commands



Notice!

The sequence in which the individual bytes of the commands and of the protocol must be transmitted in order to be processed by the LES corresponds to the "little-endian" byte sequence. The response of the LES also corresponds to the "little-endian" standard. For further information, see the notice in chapter 10.2.

All other commands are acknowledged with 'Not Ack'=0x414E; the command is not processed.

Additional commands are available in command mode.

10.3.1 Elementary commands

Using the *Connect to sensor* and *Disconnect from sensor* commands, a connection between control and sensor is established or terminated. The communication with the LES is carried out via the ports previously configured in LESsoft.

Command from control to LES		Answer from LES to control	
Command no.	Meaning	Command no.	Meaning
0x434E	Connect to Sensor	0x4141	Connection established, the sensor is permanently connected. The sensor status (bytes 17 and 18) can be used to detect whether the sensor is connected.
		0x414E	The transmitted command was not processed (possible sensor status: sensor is already connected or in menu mode, detailed info see chapter 10.2.4 "Status").
0x4443	Disconnect from Sensor	0x4141	Connection terminated.
		0x414E	The transmitted command was not processed (possible sensor status: sensor was already disconnected or in menu mode, detailed info see chapter 10.2.4 "Status").

Table 10.1: Connection commands

Command from control to LES		Answer from LES to control	
Command no.	Meaning	Command no.	Meaning
0x3132	Enter Command Mode	0x4141	Sensor in command mode.
		0x414E	The transmitted command was not processed (possible sensor status: sensor currently in menu mode and cannot execute any commands. Sensor is already in command mode) 1).
0x3133	Exit Command Mode	0x4141	
		0x414E	The transmitted command was not processed because the sensor was not in command mode.

Table 10.2: Command mode control commands

- 1) Detailed info on possible sensor states see chapter 10.2.4 "Status". You can determine whether the sensor is in menu mode with a quick glance at the display. Menu mode can be ended with the *Exit* menu item.

10.3.2 Commands in command mode

The following commands are available in command mode:

Command from control to LES			Answer from LES to control		
Command no.	Meaning	User data words	Command no.	Meaning	User data words
0x0001	Set Laser Gate <i>laser activation and deactivation (toggle), see chapter 10.3.3.</i>	1	0x4141	Command carried out	0
			0x414E	Command was not executed	0
0x0049	Get Actual Inspection Task <i>Get number of the current inspection task.</i>	0	0x004A	In the user data area the task number is transferred. (0 = Task0, up to 15 = Task15)	1
0x004B	Set Actual Inspection Task <i>Set number of the current inspection task, see chapter 10.3.3.</i>	2	0x4141 ¹⁾	The inspection task has been set	0
			0x414E ²⁾	The transmitted command was not processed	0
0x005B ^{3) 4)}	Get Single User Parameter <i>Reads specific LES parameters, e.g., whether the output of X-coordinates is deactivated.</i>	1	0x005C	Parameter is output	1
			0x414E	The transmitted command was not processed	0
0x0059 ^{3) 4)}	Set Single User Parameter <i>Writes specific LES parameters in the sensor, e.g., deactivate output of X-coordinates.</i>	3	0x4141	Parameter was set	0

Table 10.3: Sensor control commands

- 1) 0x4141 = Acknowledge: Execution of the command is confirmed
- 2) 0x414E = Not Acknowledge or Error: Command has not been executed
- 3) Beginning with firmware V01.20
- 4) The command acts globally on all inspection tasks.

Attention!

If the command is used to deactivate the output of X-coordinates, only Z-coordinates are transmitted. LESsoft can be used to depict 2D- and 3D-views. The sensor can only be reset to again transmit X- and Z-coordinates by means of command number 0x0059 when using parameter ID 0x07D4. The sensor can also be reset to factory settings via the keyboard and display, but all other sensor settings are lost as well.

10.3.3 User data in command mode (command parameters)

Set Laser Gate

For sensor control command 0x0001, one word of user data is transmitted to the sensor:

Byte	MSB				High-Byte				LSB	MSB				Low-Byte				LSB	Meaning of the bits		
31...32	-	-	-	-	-	-	-	-	-	-	-	-	-	-	-	-	-	-	-	-	LF = Laser Flag

LF=0 switches the Laser off, LF=1 switches the laser on.

Set Actual Inspection Task

For sensor control command 0x004B, two words of user data are transmitted to the sensor:

Byte	MSB				High-Byte				LSB	MSB				Low-Byte				LSB	Meaning of the bits		
31...32	-	-	-	-	-	-	-	-	-	-	-	-	-	-	-	-	N4	N3	N2	N1	Number of the inspection task to be configured (0 = Task0 ... 15 = Task 15)
33...34	-	-	-	-	-	-	-	-	-	-	-	-	-	-	-	-	-	-	-	SF	SF = SaveFlag

If SF=0 then the inspection task is changed only temporarily.

If SF=1 then the newly set inspection task is retained even after a restart of the LES.

Get Actual Inspection Task

The LES responds to sensor control command 0x0049 with 0x004A and one word of user data:

Byte	MSB				High-Byte				LSB	MSB				Low-Byte				LSB	Meaning of the bits		
31...32	-	-	-	-	-	-	-	-	-	-	-	-	-	-	-	-	N4	N3	N2	N1	Number of the configured inspection task (0 = Task0 ... 15 = Task 15)

Set Scan Number

For sensor control command 0x0053, one word of user data is transmitted to the sensor:

Byte	High-Byte				Low-Byte				Meaning of the bits								
	MSB	High-Byte		LSB	MSB	Low-Byte		LSB									
31...32	S16	S15	S14	S13	S12	S11	S10	S9	S8	S7	S6	S5	S4	S3	S2	S1	New scan number that is to be set

With the sensor control command **Set Scan Number**, it is possible to set a uniform scan number for the transmission protocol for multiple sensors operated in cascaded operation. A description of cascaded operation can be found in chapter 4.2.4.



Notice!

1. Switch the master (sensor 1) to command mode. Continuous measurement is stopped as a result. In command mode, the cascading output is not active!
2. Set an arbitrary scan number with command 0x0053 for the master.
3. Successively switch all slaves (sensor 2, 3, ...) to command mode and set the same scan number for each individual slave that you set previously under item 2 for the master.
4. Switch the slaves back to measure mode.
5. Switch the master to measure mode.

Set Single Inspection Task Parameter (beginning with firmware V01.40!)

Individual parameters of the active inspection task can be changed with sensor control command 0x006D. The following parameters can be changed:

- Name of an inspection task,
- Operation Mode: Free Running or Input Triggered,
- Enabling of activation (Activation Input: Regard or Disregard),
- Cascading Output: Enable or Disable,
- Exposure duration of the laser (Light Exposure),
- Detection range of the LPS (Field of View).

Command syntax from control to sensor:

Startseq. 1	Startseq. 2	Fill character	Command no.	Fill character	Packet no.	Fill character	Transaction no.	Status	Encoder H	Encoder L	Fill character	Scan no.	Type	Number of pieces of data
0xFFFF	0xFFFF	0x0000	0x006D	0x0000	0x0000	0x0000	0x0000	0x0000	0x0000	0x0000	0x0000	0x0000	0x0010	0x0003-0x000E

Byte	High-Byte				Low-Byte				Meaning of the bits
	MSB	High-Byte		LSB	MSB	Low-Byte		LSB	
31...32								SF	SF = SaveFlag
33...34									Parameter ID for parameter selection
35...58									Parameter value[s] dependent on parameter ID

Parameters and settings:

If SF=0, then the parameter is changed only temporarily.

If SF=1, the parameter is retained even following a restart of the LES.

Parameter ID	Parameter meaning	Valid parameter values	Parameter data type	Number of parameter values
0x0BB9	Name of the active inspection task	Maximum length: 12 ASCII characters, each character is saved as a 16-bit word	CHAR	12
0x0BBA	Operating mode	0=Operation Mode: Free Running; 1=Operation Mode Input Triggered	UINT8	1
0x0BBB	Enabling of activation	0=Activation Input: Disregard; 1=Activation Input: Regard	UINT8	1
0x0BBC	Enabling of the cascading output	0=Cascading Output: Disable; 1=Cascading Output: Enable	UINT8	1
0x0BBD	Exposure duration of the laser	0 = Normal (approx. 261 µs) 1 = Bright Objects (approx. 97 µs) 2 = Dark Objects (approx. 655 µs) 3 = Normal to Bright Objects (approx. 328 µs) 4 = Manual Setting (the exposure time is set using parameter ID 0x0BBE)	UINT8	1
0x0BBE	Manual adjusting of the exposure duration	Permissible value range LES 36H/VC6, LES 36H/PB: 739...13109; LES 36/VC6, LES 36/PB: 973...13109 (exposure time unit in 1/10µs). The duration of exposure is set incrementally in the sensor. The actual duration of exposure can deviate slightly from the parameter value transmitted. The exposure duration set can be accessed with the "Get Single Inspection Task Parameter" (0x006F) command in combination with parameter ID 0x0BBD.	UINT16	1
0x0BBF	X-coordinate detection range	2 signed X-values for Field of View, value 1: Minimum X Value, value 2: Maximum X Value, permissible value range LES 36H/VC6, LES 36H/PB: -700...700; LES 36/VC6, LES 36/PB: -3000...3000 (unit in 1/10 mm)	SINT16	2
0x0BC0	Z-coordinate detection range	2 non-signed Z-values for Field of View, value 1: Minimum Z Value, value 2: Maximum Z Value, permissible value range LES 36H/VC6, LES 36H/PB: 1950...6100; LES 36/VC6, LES 36/PB: 1900...8100 (unit in 1/10mm)	UINT16	2

Sensor response:

Command number	Meaning	User data words
0x4141	"Ack": the command has been successfully executed.	0
0x414E	"Not Ack": the command has not been executed.	0

Get Single Inspection Task Parameter (beginning with firmware V01.40!)

Individual parameters of the active inspection task can be output with sensor control command 0x006F. The following parameters can be accessed:

- Name of the active inspection task,
- Number of the active inspection task,
- Operation Mode: Free Running or Input Triggered,
- Setting of activation (Activation Input: Regard or Disregard),
- Setting of cascading output (Cascading Output: Enable or Disable),
- Exposure duration of the laser (Light Exposure),
- Detection range of the LES (Field of View).

Command syntax from control to sensor:

Startseq. 1	Startseq. 2	Fill character	Command no.	Fill character	Packet no.	Fill character	Transaction no.	Status	Encoder H	Encoder L	Fill character	Scan no.	Type	Number of pieces of data
0xFFFF	0xFFFF	0x0000	0x006F	0x0000	0x0000	0x0000	0x0000	0x0000	0x0000	0x0000	0x0000	0x0000	0x0010	0x0001

Byte	MSB	High-Byte	LSB	MSB	Low-Byte	LSB	Meaning of the bits
31...32							Parameter ID which can be accessed

Parameters and settings:

Parameter ID	Parameter meaning
0x0BB8	Number of the active inspection task
0x0BB9	Name of an inspection task
0x0BBA	Operating mode
0x0BBB	Enabling of activation
0x0BBC	Enabling of the cascading output
0x0BBD	Exposure duration of the laser
0x0BBE	Manual adjusting of the exposure duration
0x0BBF	X-coordinate detection range
0x0BC0	Z-coordinate detection range

Answer from sensor to control:

Startseq. 1	Startseq. 2	Fill character	Command no.	Fill character	Packet no.	Fill character	Transaction no.	Status	Encoder H	Encoder L	Fill character	Scan no.	Type	Number of pieces of data
0xFFFF	0xFFFF	0x0000	0x0070	0x0000	0x0000	0x0000	0x006F	0x0000	0x0000	0x0000	0x0000	0x0000	0x0010	0x0009-0x0014

Byte	MSB	High-Byte				LSB	MSB	Low-Byte				LSB	Meaning of the bits
31...32													Parameter ID for parameter selection
33...34													Data type: 1 = UINT8; 2 = UINT16, 5 = SINT16, 7 = CHAR
35...36													Number of parameter values (byte 47 and following)
37...38													Lower limit of parameter value (HighWord)
39...40													Lower limit of parameter value (LowWord)
41...42													Upper limit of parameter value (HighWord)
43...44													Upper limit of parameter value (LowWord)
45...46													No meaning
47...70													Parameter value(s) of accessed parameter ID

Set Single User Parameter (beginning with firmware V01.20)

When used with parameter ID 0x07D4, sensor control command 0x0059 can switch the transmission of X-coordinates in measure mode on and off. The quantity of data transmitted in measure mode can thereby be reduced by one half (useful for applications that only require Z-coordinates and for controls with small Ethernet receive buffer).

Command syntax from control to LES:

Startseq. 1	Startseq. 2	Fill character	Command no.	Fill character	Packet no.	Fill character	Trans. no.	Status	Encoder H	Encoder L	Fill character	Scan no.	Type	No. of data
0xFFFF	0xFFFF	0x0000	0x0059	0x0000	0x0000	0x0000	0x0000	0x0000	0x0000	0x0000	0x0000	0x0000	0x0010	0x0003

When using sensor control command 0x0059 with parameter ID 0x07D4, three words of user data are transmitted to the sensor:

Byte	MSB	High-Byte				LSB	MSB	Low-Byte				LSB	Meaning of the bits
31...32	-	-	-	-	-	-	-	-	-	-	-	-	SF = SaveFlag
33...34	0	0	0	0	1	1	1	1	1	0	1	0	Parameter ID for Disable x-Output = 0x07D4
35...36	-	-	-	-	-	-	-	-	-	-	-	-	OF = Output Flag

If SF=0 then the output of X-coordinates is changed only temporarily.

If SF=1 then the output of X-coordinates is retained even after a restart of the LES.

If OF=0, then X- and Z-coordinates are transmitted.

If OF=1, then only Z-coordinates are transmitted (X-coordinates are deactivated).

When used with parameter ID 0x07D8, sensor control command 0x0059 can be used to extend the transmission pause between the Z- and X-data packets from 0.1ms (factory setting) to up to 1 ms (useful in applications with controls with slow, small Ethernet receive buffer).

When using sensor control command 0x0059 with parameter ID 0x07D8, three words of user data are transmitted to the sensor:

Byte	MSB			High-Byte			LSB			MSB			Low-Byte			LSB			Meaning of the bits
31...32	-	-	-	-	-	-	-	-	-	-	-	-	-	-	-	-	-	SF	SF = SaveFlag
33...34	0	0	0	0	0	1	1	1	1	1	0	1	1	0	0	0	0	Parameter ID for Disable x-Output = 0x07D4	
35...36	-	-	-	-	-	-	-	-	-	-	-	-	-	P4	P3	P2	P1	Duration of the transmission pause between the Z- and X-data packets in 0.1 ms increments (0 = 0.1 ms ... 9 = 1.0 ms)	

If SF=0, the duration of the transmission pause is changed only temporarily.

If SF=1, the duration of the transmission pause is retained even following a restart of the LES.



Notice!

If the transfer of X-coordinates is switched off in measure mode, no visualization of measurement data can be performed in the 2D- and 3D-views in LESsoft.

Set Single User Parameter (beginning with firmware V01.40!)

When using parameter ID 0x07DB, sensor control command 0x0059 can be used to activate a median filter for the Z-coordinates. By activating the median filter, the Z-coordinates of the measurement values are smoothed out, while occurring edges are retained. If the median filter is activated, small interferences and structures can be suppressed.

When using sensor control command 0x0059 with parameter ID 0x07DB, three words of user data are transmitted to the sensor:

Byte	MSB			High-Byte			LSB			MSB			Low-Byte			LSB			Meaning of the bits
31...32	-	-	-	-	-	-	-	-	-	-	-	-	-	-	-	-	-	SF	SF = SaveFlag
33...34						1	1	1	1	1	0	1	1	0	1	1	Parameter ID for median filter = 0x07DB		
35...36	-	-	-	-	-	-	-	-	-	-	-	-	-	-	-	-	1	1= median filter active 0= median filter inactive	

Get Single User Parameter (beginning with firmware V01.20 !)

When using parameter ID 0x07D4, sensor control command 0x005B can be used to check whether X-coordinates are output.

Command syntax:

Startseq. 1	Startseq. 2	Fill character	Command no.	Fill character	Packet no.	Fill character	Trans. no.	Status	Encoder H	Encoder L	Fill character	Scan no.	Type	No. of data
0xFFFF	0xFFFF	0x0000	0x005B	0x0000	0x0000	0x0000	0x0000	0x0000	0x0000	0x0000	0x0000	0x0000	0x0010	0x0001

When using sensor control command 0x005B with parameter ID 0x07D4, one word of user data is transmitted to the sensor:

Byte	MSB	High-Byte			LSB	MSB	Low-Byte			LSB	Meaning of the bits								
31...32	0	0	0	0	0	1	1	1	1	1	1	0	1	0	1	0	0	0	Parameter ID for Disable x-Output = 0x07D4

The sensor responds with 0x005C and returns one word of user data.

Byte	MSB	High-Byte			LSB	MSB	Low-Byte			LSB	Meaning of the bits								
31...32	-	-	-	-	-	-	-	-	-	-	-	-	-	-	-	-	-	OF	OF = Output Flag

If OF=0 then X- and Z-coordinates are transmitted.

If OF=1 then only Z-coordinates are transmitted (X-coordinates are deactivated).

When using parameter 0x07D8, sensor control command 0x005B can be used to query the duration of the transmission pause between the Z- and X-data packets.

Command syntax:

Startseq. 1	Startseq. 2	Fill character	Command no.	Fill character	Packet no.	Fill character	Trans. no.	Status	Encoder H	Encoder L	Fill character	Scan no.	Type	No. of data
0xFFFF	0xFFFF	0x0000	0x005B	0x0000	0x0000	0x0000	0x0000	0x0000	0x0000	0x0000	0x0000	0x0000	0x0010	0x0001

When using sensor control command 0x005B with parameter ID 0x07D8, one word of user data is transmitted to the sensor:

Byte	MSB	High-Byte			LSB	MSB	Low-Byte			LSB	Meaning of the bits							
31...32	0	0	0	0	0	1	1	1	1	1	0	1	1	0	0	0	0	Parameter ID for transmission pause = 0x07D8

The sensor responds with 0x005C and returns one word of user data.

Byte	MSB	High-Byte			LSB	MSB	Low-Byte			LSB	Meaning of the bits				
31...32	-	-	-	-	-	-	-	-	-	-	P4	P3	P2	P1	Duration of the transmission pause between the Z- and X-data packets in 0.1 ms increments (0 = 0.1 ms ... 9 = 1.0 ms)

When using parameter ID 0x07DB, sensor control command 0x005B can be used to check whether the median filter is activated.

Command syntax:

Startseq. 1	Startseq. 2	Fill character	Command no.	Fill character	Packet no.	Fill character	Trans. no.	Status	Encoder H	Encoder L	Fill character	Scan no.	Type	No. of data
0xFFFF	0xFFFF	0x0000	0x005B	0x0000	0x0000	0x0000	0x0000	0x0000	0x0000	0x0000	0x0000	0x0000	0x0010	0x0001

When using sensor control command 0x005B with parameter ID 0x07DB, one word of user data is transmitted to the sensor:

Byte	MSB	High-Byte			LSB	MSB	Low-Byte			LSB	Meaning of the bits				
31...32					1	1	1	1	0	1	1	0	1	1	Parameter ID for median filter = 0x07DB

The sensor responds with 0x005C and returns one word of user data.

Byte	MSB	High-Byte			LSB	MSB	Low-Byte			LSB	Meaning of the bits				
31...32														1	1= median filter active 0= median filter inactive

10.3.4 Commands in measure mode

The following commands are available in measure mode:

Command from control to LES			Answer from LES to control		
Command no.	Meaning	User data words	Command no.	Meaning	User data words
0x4554	Ethernet Trigger <i>With the Ethernet Trigger command, a single measurement is triggered in measure mode, similar to triggering via the trigger input.</i> <i>Prerequisite is that the LES be configured with LESSoft under Operation Mode to Input Triggered.</i> <i>A connection to the sensor must exist before the Ethernet Trigger command can be used.</i>	0	0x5354	The evaluation telegram is sent as an answer (status and measurement values), see chapter 10.2.9.	1 packet @ 75
			0x414E	The transmitted command was not processed.	0
0x4541	Ethernet Activation <i>The Ethernet Activation command is used in measure mode to switch the laser on and off corresponding to the user data word.</i> <i>Prerequisite is that the LES be configured with LESSoft under Activation Input Mode to Regard.</i> <i>A connection to the sensor must exist before the command can be used.</i>	0	0x5354	The evaluation telegram is sent as an answer (status and measurement values), see chapter 10.2.9.	1 packet @ 75
			0x414E	The transmitted command was not processed.	0

Table 10.4: Commands in measure mode

10.4 Working with the protocol



Notice!

The values are displayed in hexadecimal representation (0x...). The values are only transmitted in "Little-Endian" format. For further information, see the notice in chapter 10.2.

Command without user data

Connect to Sensor

PC to LES:

Startseq. 1	Startseq. 2	Fill character	Command no.	Fill character	Packet no.	Fill character	Trans. no.	Status	Encoder H	Encoder L	Fill character	Scan no.	Type	No. of data
0xFFFF	0xFFFF	0x0000	0x434E	0x0000	0x0000	0x0000	0x0000	0x0000	0x0000	0x0000	0x0000	0x0000	0x0000	0x0000

LES to PC (command executed):

Startseq. 1	Startseq. 2	Fill character	Command no.	Fill character	Packet no.	Fill character	Trans. no.	Status	Encoder H	Encoder L	Fill character	Scan no.	Type	No. of data
0xFFFF	0xFFFF	0x0000	0x4141	0x0000	0x0000	0x0000	0x434E	0x0000	0x0000	0x0000	0x0000	0x0000	0x0000	0x0000

Command with user data

Set Actual Inspection Task (LES in command mode, activate Task 15 and do not store in volatile memory)

PC to LES:

Startseq. 1	Startseq. 2	Fill character	Command no.	Fill character	Packet no.	Fill character	Trans. no.	Status	Encoder H	Encoder L	Fill character	Scan no.	Type	No. of data	User data	User data
0xFFFF	0xFFFF	0x0000	0x004B	0x0000	0x0000	0x0000	0x0000	0x0000	0x0000	0x0000	0x0000	0x0000	0x0000	0x0002	0x000F	0x0001

LES to PC (command executed):

Startseq. 1	Startseq. 2	Fill character	Command no.	Fill character	Packet no.	Fill character	Trans. no.	Status	Encoder H	Encoder L	Fill character	Scan no.	Type	No. of data
0xFFFF	0xFFFF	0x0000	0x4141	0x0000	0x0000	0x0000	0x004B	0x0000	0x0000	0x0000	0x0000	0x0000	0x0000	0x0000

10.5 Operation with LxS_Lib.dll

The LxS_Lib.dll is a .NET 2.0-compatible collection of functions which considerably facilitates the integration of all Leuze light section sensors (LPS, LRS and LES) into PC environments. The LxS_Lib.dll can be used in a variety of programming languages, such as C#, Visual Basic, etc. The integration into MatLab is also possible.

The DLL can control several light section sensors via Ethernet.

The LxS_Lib.dll supports the following functions, among others:

- Establishment/deactivation of sensor connection
- Evaluation of sensor state
- Triggering, activation via Ethernet
- Activation of individual inspection tasks
- Loading and saving all created inspection tasks
- Activation of inspection tasks
- Parameter changes of the active inspection task

In addition, the LxS_Lib.dll enables the evaluation of specific user data of the LPS, LES or LRS. With the LRS and LES, all sensor information and intermediate results are available so that much more complicated evaluations can be realized in the process control.

Access

The library is contained on the supplied product CD. Alternatively, you can download the program in the Internet at www.leuze.com.

10.6 Operation with native C++ DLL

The native C++ DLL was created specifically for integration in C++ programs. It consists primarily of the LxS Lib functions:

- Establishment/deactivation of sensor connection
- Evaluation of sensor state
- Triggering, activation via Ethernet
- Activation of individual inspection tasks
- Activation of inspection tasks
- Parameter changes of the active inspection task

Only the loading / saving of all created inspection tasks is not possible and must be performed via the supplied LxSsoft.

10.7 Additional support when integrating sensors

Additional tools (e.g. MatLab example, function modules S7, protocol plain-text decoding, UDP terminal) are available. Please contact your Leuze distributor or service organization to acquire these.

11 **Integration of the LES 36.../PB in the PROFIBUS**

11.1 **General information**

The LES 36/PB and LES 36HI/PB is designed as a PROFIBUS DP/DPV1 compatible slave. The input/output functionality of the sensor is defined by the corresponding GSD file. The baud rate of the data to be transmitted is max. 6Mbit/s under production conditions.

For operation, the GSD file is to be appropriately modified.

The LES 36.../PB supports automatic detection of the baud rate.

Characteristics of LES 36.../PB

- Ethernet and PROFIBUS can be used in measure mode as fully-fledged interfaces.
- If the sensor is in menu mode, the PROFIBUS is active. Queries from the control are not processed and the process data are frozen (indicated by the constant scan number).
- If the sensor is in command mode, the PROFIBUS is active. Queries from the control are not processed and the process data are frozen (indicated by the constant scan number).
- If the sensor is simultaneously operated with LESsoft and PROFIBUS, the PROFIBUS is active. Queries from the control are processed with a delay; the process data are also updated with a delay (indicated by the slowly increasing scan numbers). The update occurs every 200ms.
- The input signals via Ethernet, PROFIBUS and signal lines have equal priority. The first incoming signal is executed.
- The sensor is configured via the LESsoft configuration software.

Compared to device model LES 36.../C6 with analog output, the PROFIBUS model has the following additional functions:

- Output of up to eight measurement values (two measurement values per EAW).
- Output of the state of the object detection in up to four EAWs and four AWs.
- Output of the state of the edge detection AND object detection (logical AND combination).
- Transmission of scan number, sensor state and of the current inspection task.
- Selection of up to 16 inspection tasks.
- Activation and trigger via PROFIBUS.

11.2 PROFIBUS address assignment

The various possibilities for setting the slave address are described in the following. Automatic address assignment via the PROFIBUS (slave address **126**) is preset.

Automatic address assignment

The LES 36.../PB supports automatic detection of the baud rate and automatic address assignment via the PROFIBUS.

The address of the PROFIBUS participant can be set automatically by the commissioning tool of the PROFIBUS system (a class 2 PROFIBUS master). For this purpose, the slave address must be set to value **126** in the sensor (factory setting).

The commissioning master checks whether a slave has address **126** and then assigns this slave a node address smaller than **126**. This address is permanently stored in the participant. The changed address can then be queried (and, if necessary, changed again) via the display or LESsoft.

Address assignment with LESsoft

The PROFIBUS slave address can be set via LESsoft. This setting can be stored on the PC together with the other sensor settings.

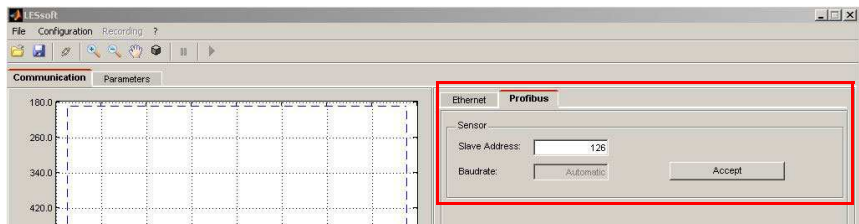


Figure 11.1: PROFIBUS address assignment with LESsoft

Address assignment with key pad and display

Setting the address with the key pad and display allows the sensor to be integrated in a PROFIBUS system while in the field with no additional tools. See "Slave Address" on page 55. The set address can also be queried by the user with no additional tools.



Notice!

After changing the PROFIBUS slave address via LESsoft or with the display/key pad, a power-on reset must be performed in order to permanently accept the address.

11.3 General information about the GSD file

If the LES 36.../PB is operated in a PROFIBUS network, configuration can be performed exclusively via the LESsoft configuration software. The functionality of the inputs/outputs of the light section sensor to the control is defined via modules. Using a user-specific configuration tool, the respective required modules are integrated and configured according to the measurement application during PLC programming.

During operation of the light section sensor on the PROFIBUS, the functionality of the inputs/outputs is assigned default values. If these values are not changed by the user, the device operates with the default setting set by Leuze electronic on delivery. Please refer to the following module descriptions for the default settings of the device.



Notice!

*At least one module from the GSD file must be activated in the configuration tool of the control, usually **module M1, M2 or M3**.*



Notice!

Some controls make available a so-called "universal module". This module must not be activated for the LES 36.../PB.



Attention!

The device makes available a PROFIBUS interface and an Ethernet interface. Both interfaces can be operated in parallel.



Notice!

For test purposes, parameters can be changed on a LES 36.../PB operated on PROFIBUS. At this time, object detection is not possible on PROFIBUS.



Notice!

*All input and output modules described in this documentation are described **from the perspective of the control**:*

Described inputs (I) are inputs in the control.

Described outputs (O) are outputs in the control.

Described parameters (P) are parameters of the GSD file in the control.



Notice!

*The current version of the GSD file **LEUZE403.GSD** for the LES 36.../PB can be found on the Leuze website **www.leuze.com**.*

11.4 Overview of the GSD files

The LES 36.../PB has one module slot. Select the corresponding module from the GSD to set the process data of the LES 36.../PB that are to be transmitted. Several modules are available for selection. Beginning with the simplest input module **M1**, additional inputs are included with the subsequent modules. All available output data are already contained in module **M1**. The modules with higher numbers contain the modules with the lower numbers (example: **M2** contains **M1** and the extensions of **M2**).



Notice!

As the module number increases, so too does the number of user data bytes that are to be transmitted.

The maximum measurement rate of 100Hz can only be ensured up to module **M2**.

Therefore, only modules which contain the data actually required should be selected, i.e. the smallest possible module number should be selected.



Notice!

All input and output modules described in this documentation are described **from the perspective of the control**:

Described inputs (I) are inputs in the control.

Described outputs (O) are outputs in the control.

Described parameters (P) are parameters of the GSD file in the control.

Output data (from viewing position of control)

Position (bytes)	Name	Bits in byte								Value range	Meaning
		Bit7	Bit6	Bit5	Bit4	Bit3	Bit2	Bit1	Bit0		
0	uTrigger	Trig_7	Trig_6	Trig_5	Trig_4	Trig_3	Trig_2	Trig_1	Trig_0	0 ... 255	Triggering via PROFIBUS (in the case of changes)
1	uActivation	-	-	-	-	-	-	-	Act_On	0 ... 1	Activation (=1) or deactivation (=0) of the sensor
2	ulnspTask	-	-	-	-	IT_b3	IT_b2	IT_b1	IT_b0	0 ... 15	Inspection task of PROFIBUS master and save flag (B7)

Table 11.1: PROFIBUS - Overview of output data (from viewing position of control)

Input data (from viewing position of control)

GSE Module	Position (bytes)	Name	Bits in byte							Value range	Meaning	
			Bit7	Bit6	Bit5	Bit4	Bit3	Bit2	Bit1			Bit0
M3 - 22 bytes M2 - 16 bytes M1 - 8 bytes	0	wScanNum (HighByte)	SN_b15	SN_b14	SN_b13	SN_b12	SN_b11	SN_b10	SN_b9	SN_b8	0 ... 255	Scan number (HighByte)
	1	wScanNum (LowByte)	SN_b7	SN_b6	SN_b5	SN_b4	SN_b3	SN_b2	SN_b1	SN_b0	0 ... 255	Scan number (LowByte)
	2	uSensorInfo	Edge4	Edge3	Edge2	Edge1	IT_b3	IT_b2	IT_b1	IT_b0	0 ... 255	SensorInfo (state of edge detection, inspection task no.)
	3	uSensorState	ErrM	Cmd	Menu	Meas	ErrF	WarnF	active	connect	0 ... 255	Sensor state
	4	uResultEdge/Logic	LEAW4	LEAW3	LEAW2	LEAW1	DAW4	DAW3	DAW2	DAW1	0 ... 255	Obj. Point/EAW State 1...4, AW Logic Ana. Depth 1...4
	5	uResultAWs	AW08	AW07	AW06	AW05	EAW4	EAW3	EAW2	EAW1	0 ... 255	State of AW05...AW08 and EAW1...EAW4
	6	wEdgeAW1Data1 (HighByte)	sign	OP_b14	OP_b13	OP_b12	OP_b11	OP_b10	OP_b9	OP_b8	-32768...+32767	Signed measurement value 1 in Edge Analysis Window EAW1
	7	wEdgeAW1Data1 (LowByte)	OP_b7	OP_b6	OP_b5	OP_b4	OP_b3	OP_b2	OP_b1	OP_b0		
	8	wEdgeAW1Data2 (HighByte)	sign	OP_b14	OP_b13	OP_b12	OP_b11	OP_b10	OP_b9	OP_b8	-32768...+32767	Signed measurement value 2 in Edge Analysis Window EAW1
	9	wEdgeAW1Data2 (LowByte)	OP_b7	OP_b6	OP_b5	OP_b4	OP_b3	OP_b2	OP_b1	OP_b0		
	10	wEdgeAW2Data1 (HighByte)	sign	OP_b14	OP_b13	OP_b12	OP_b11	OP_b10	OP_b9	OP_b8	-32768...+32767	Signed measurement value 1 in Edge Analysis Window EAW2
	11	wEdgeAW2Data1 (LowByte)	OP_b7	OP_b6	OP_b5	OP_b4	OP_b3	OP_b2	OP_b1	OP_b0		
	12	wEdgeAW2Data2 (HighByte)	sign	OP_b14	OP_b13	OP_b12	OP_b11	OP_b10	OP_b9	OP_b8	-32768...+32767	Signed measurement value 2 in Edge Analysis Window EAW2
	13	wEdgeAW2Data2 (LowByte)	OP_b7	OP_b6	OP_b5	OP_b4	OP_b3	OP_b2	OP_b1	OP_b0		
	14	wEdgeAW3Data1 (HighByte)	sign	OP_b14	OP_b13	OP_b12	OP_b11	OP_b10	OP_b9	OP_b8	-32768...+32767	Signed measurement value 1 in Edge Analysis Window EAW3
	15	wEdgeAW3Data1 (LowByte)	OP_b7	OP_b6	OP_b5	OP_b4	OP_b3	OP_b2	OP_b1	OP_b0		
	16	wEdgeAW3Data2 (HighByte)	sign	OP_b14	OP_b13	OP_b12	OP_b11	OP_b10	OP_b9	OP_b8	-32768...+32767	Signed measurement value 2 in Edge Analysis Window EAW3
	17	wEdgeAW3Data2 (LowByte)	OP_b7	OP_b6	OP_b5	OP_b4	OP_b3	OP_b2	OP_b1	OP_b0		
	18	wEdgeAW4Data1 (HighByte)	sign	OP_b14	OP_b13	OP_b12	OP_b11	OP_b10	OP_b9	OP_b8	-32768...+32767	Signed measurement value 1 in Edge Analysis Window EAW4
	19	wEdgeAW4Data1 (LowByte)	OP_b7	OP_b6	OP_b5	OP_b4	OP_b3	OP_b2	OP_b1	OP_b0		
	20	wEdgeAW4Data2 (HighByte)	sign	OP_b14	OP_b13	OP_b12	OP_b11	OP_b10	OP_b9	OP_b8	-32768...+32767	Signed measurement value 2 in Edge Analysis Window EAW4
21	wEdgeAW4Data2 (LowByte)	OP_b7	OP_b6	OP_b5	OP_b4	OP_b3	OP_b2	OP_b1	OP_b0			

11.5 Output data description

PROFIBUS trigger

So that a measurement can be triggered on each PROFIBUS cycle, the PROFIBUS trigger of the LES responds to a change of master output byte **uTrigger**. The control only needs to increment the trigger value in order to initiate a new measurement.

The maximum trigger frequency is 100Hz. If triggering occurs during a measurement, the trigger signal is ignored, as is the case in the **Free Running** operating mode (shown on display: fRun).

Activation - Sensor activation

Alternatively, activation can be switched on in detection mode via activation input **InAct** (pin 2 on X1) or master output **uActivation** = 1.



Notice!

With the **Disregard** parameter setting in LESsoft, the sensor is always activated; input **InAct** and activation via PROFIBUS are ignored.

Inspection Tasks - Selection of inspection tasks

With master output **ulnspTask** (bits IT_b3 ... IT_b0 in output data byte 2), inspection tasks 0 ... 15 can be selected. The changeover occurs in cyclical IO operation and lasts approx. 70ms. During the changeover, the PROFIBUS IO data are frozen and the internal reconfiguration occurs. This is indicated by the scan number, which does not increase.

After changing the inspection task, the PROFIBUS IO data of the sensor are again updated. Value **uSensorInfo** in the input data then indicates the inspection task set in the sensor and the scan number again increases with each new measurement.



Attention!

While configuring the LES with LESsoft via Ethernet, global parameter **Enable External Inspection Task Selection** should be switched off so that the inspection task is not automatically changed by the control during configuration.

After configuring, the check box for this parameter must be selected again before the configuration is transmitted to the sensor by means of **Transmit Configuration To Sensor**.

Otherwise, inspection tasks can no longer be selected via PROFIBUS!

11.6 Input data description

Several modules are available for selection. Beginning with the simplest input module **M1**, additional inputs are included with the subsequent modules. All available output data are already contained in module **M1**. The modules with higher numbers the modules with the lower numbers (example: **M2** contains **M1** and the extensions of **M2**).

11.6.1 Module M1

Module **M1** provides the minimum required PROFIBUS data.
 The maximum measurement rate of 100Hz is ensured if this module is set.

Scan number

The scan number is made available as PROFIBUS master input. This is a 16-bit value (bytes **wScanNum**, HighByte and LowByte).

The scan number is increased by 1 on each measurement. In **FreeRunning** mode, the scan number also increases even if no sensor is explicitly activated. In triggered mode, the scan number is increased on each (successful) trigger.

If the inspection task is changed, the PROFIBUS IO data of the sensor are frozen and the scan number does not change.



Notice!

It is recommended that the scan number be monitored in the application in order to determine whether the data are actually new.

Sensor info

Byte **uSensorInfo** contains in the high nibble (bits 7 ... 4) the **Edge State** (state of edge detection) of the sensor of all four EAWs **Edge1** ... **Edge4** and in the low nibble (bits 3 ... 0) the inspection task **IT_b3** ... **IT_b0** set in the sensor.

Bit	Designation	Meaning
7	Edge4	State of the edge detection (Edge State) in EAW4: 0 = not ok (red), 1 = ok (green)
6	Edge3	State of the edge detection (Edge State) in EAW3: 0 = not ok (red), 1 = ok (green)
5	Edge2	State of the edge detection (Edge State) in EAW2: 0 = not ok (red), 1 = ok (green)
4	Edge1	State of the edge detection (Edge State) in EAW1: 0 = not ok (red), 1 = ok (green)
3	IT_b3	Number of the currently set inspection task. Value range 0 ... 15
2	IT_b2	
1	IT_b1	
0	IT_b0	

Table 11.2: Input data byte **uSensorInfo**

Sensor state

Sensor status byte **uSensorState** contains the following information:

Bit	Designation	Meaning
7	ErrM	Error mode, permanent sensor malfunction
6	Cmd	Command mode: the sensor is in command mode. The queries from the control are not processed and the measurement data are frozen (indicated by the constant scan number).
5	Menu	Menu mode: the sensor is operated by the user via the display/key pad. The queries from the control are not processed and the measurement data are frozen (indicated by the constant scan number).
4	Meas	Measure mode: the sensor is in measure mode. This is the normal operating state in which the maximum measurement rate is attained.
3	ErrF	Error, permanent sensor malfunction.
2	WarnF	Warning, temporary sensor malfunction.
1	active	Sensor activated.
0	connect	Sensor connected via Ethernet.

Table 11.3: Input data byte **uSensorState**

Logic

Sensor status byte **uResultEdge/Logic** contains the following information:

the high nibble (bits 7 ... 4) contains the **Object Point/EAW State** for all four EAWs; the low nibble (bits 3 ... 0) contains the **AW Logic Analysis Depth** state for all four EAWs.

Bit	Designation	Meaning
7	LEAW4	'Object Point/EAW State' for EAW4: 0 = not ok (red), 1 = ok (green)
6	LEAW3	'Object Point/EAW State' for EAW3: 0 = not ok (red), 1 = ok (green)
5	LEAW2	'Object Point/EAW State' for EAW2: 0 = not ok (red), 1 = ok (green)
4	LEAW1	'Object Point/EAW State' for EAW1: 0 = not ok (red), 1 = ok (green)
3	DAW4	State 'AW Logic Analysis Depth' for EAW4: 0 = not ok (red), 1 = ok (green)
2	DAW3	State 'AW Logic Analysis Depth' for EAW4: 0 = not ok (red), 1 = ok (green)
1	DAW2	State 'AW Logic Analysis Depth' for EAW4: 0 = not ok (red), 1 = ok (green)
0	DAW1	State 'AW Logic Analysis Depth' for EAW4: 0 = not ok (red), 1 = ok (green)

Table 11.4: Input data byte **uResultEdge/Logic**

Object detection

Sensor status byte **uResultAWs** contains the following information:

the high nibble (bits 7 ... 4) contains the object detection state of the four AWs; the low nibble (bits 3 ... 0) contains the object detection state of the four EAWs (see "Current Status" under "Analysis Window Definitions" on page 78).

Bit	Designation	Meaning
7	AW08	State of the object detection for AW08: 0 = not detected or not activated, 1 = detected
6	AW07	State of the object detection for AW07: 0 = not detected or not activated, 1 = detected
5	AW06	State of the object detection for AW06: 0 = not detected or not activated, 1 = detected
4	AW05	State of the object detection for AW05: 0 = not detected or not activated, 1 = detected
3	EAW4	State of the object detection for EAW4: 0 = not detected or not activated, 1 = detected
2	EAW3	State of the object detection for EAW3: 0 = not detected or not activated, 1 = detected
1	EAW2	State of the object detection for EAW2: 0 = not detected or not activated, 1 = detected
0	EAW1	State of the object detection for EAW1: 0 = not detected or not activated, 1 = detected

Table 11.5: Input data byte **uResultAWs**

Measurement value 1 in Edge Analysis Window EAW1

This is a signed 16-bit value (bytes **wEdgeAW1Data1** HighByte and **wEdgeAW1Data1** LowByte). Measurement value 1 of Edge Analysis Window EAW1 (= Profibus Inputs 1) is output in the value (for information on configuration, see "Profibus Inputs 1 , Profibus Inputs 2" on page 81).

The **value range is -32768 ... +32767**. The measurement value has **units of 0.1 mm**, i.e., a measurement value of +1263 corresponds to 126.3mm.

Byte	Bit	Designation	Meaning
wEdgeAW1Data1 (High-Byte)	7	sign	Sign
	6	OP_b14	Measurement value
	5	OP_b13	Measurement value
	4	OP_b12	Measurement value
	3	OP_b11	Measurement value
	2	OP_b10	Measurement value
	1	OP_b9	Measurement value
	0	OP_b8	Measurement value
wEdgeAW1Data1 (Low-Byte)	7	OP_b7	Measurement value
	6	OP_b6	Measurement value
	5	OP_b5	Measurement value
	4	OP_b4	Measurement value
	3	OP_b3	Measurement value
	2	OP_b2	Measurement value
	1	OP_b1	Measurement value
	0	OP_b0	Measurement value

Table 11.6: Input data bytes **wEdgeAW1Data1** (high and low byte)

11.6.2 Module M2

The maximum measurement rate of 100Hz is ensured if this module is set.



Notice!

Module M2 contains the input data from module M1. Only the additional input data are described in this section.

Measurement value 2 in Edge Analysis Window EAW1 (wEdgeAW1Data2)

Measurement value 1 in Edge Analysis Window EAW2 (wEdgeAW2Data1)

Measurement value 2 in Edge Analysis Window EAW2 (wEdgeAW2Data2)

Measurement value 1 in Edge Analysis Window EAW3 (wEdgeAW3Data1)

These are signed, 16-bit measurement values (for information on configuration, see "Profibus Inputs 1 , Profibus Inputs 2" on page 81).



Notice!

Description see "Measurement value 1 in Edge Analysis Window EAW1" on page 119.

11.6.3 Module M3

If this module is set, the maximum measurement rate is reduced to less than 100Hz, depending on bus load.



Notice!

Module M3 contains the input data from module M2. Only the additional input data are described in this section.

Measurement value 2 in Edge Analysis Window EAW3 (wEdgeAW3Data2)

Measurement value 1 in Edge Analysis Window EAW4 (wEdgeAW4Data1)

Measurement value 2 in Edge Analysis Window EAW4 (wEdgeAW4Data2)

These are signed, 16-bit measurement values (for information on configuration, see "Profibus Inputs 1 , Profibus Inputs 2" on page 81).



Notice!

Description see "Measurement value 1 in Edge Analysis Window EAW1" on page 119.

12 Diagnostics and troubleshooting

12.1 General causes of errors

Error	Possible error cause	Measures
Control receives no measurement data	Ethernet connection interrupted	Check connection with LESsoft. See "Commissioning" on page 62.
	Control not connected to sensor	Use "To sensor" command.
Object contours not detected	Occlusion	See "Occlusion" on page 17.
	Soiling of the optics covers	Clean optics covers, see "Cleaning" on page 125.
	Ambient light	Prevent ambient light, shield sensor, see "Selecting a mounting location" on page 39. Limit detection range with LPSsoft, see "Field of View" on page 75.
	Reflections	Avoid reflections. Limit detection range with LPSsoft, see "Field of View" on page 75.
	Unsuitable exposure setting	Adapt exposure duration to the reflective properties of the objects to be detected. See "Light Exposure" on page 75.
	Object not in measurement range	Visual assessment with LESsoft, reduce working distance/position of the sensor to the object. See "Standard tab - Task Parameters panel" on page 74.
	Detection range selected too small	Configure detection range with LESsoft. "Field of View" on page 75
Sensor does not respond to commands	Sensor in measure/menu mode	Exit menu view on OLED display. Connect sensor to control. Switch sensor to command mode if necessary.
	Sensor not connected	Check settings of the Ethernet interface. Connect sensor to control.
	Sensor not activated	Activate sensor via PIN 2 on X1. Switch off activation input. See "Activation" on page 75.

Table 12.1: General causes of errors

Error	Possible error cause	Measures
No laser line	Sensor not activated.	Activate sensor via PIN 2 on X1.
	Laser was deactivated in command mode with the "Set Laser Gate" command	Switch on laser. See "Set Laser Gate" on page 101.
	Sensor in trigger mode.	Activate single measurement by means of Ethernet trigger or via PIN 5 on X1.
Sensor does not respond to trigger.	Sensor in command mode.	Exit command mode with the "Exit Command Mode" command.
	Triggering too fast.	Reduce trigger rate. The shortest possible interval between two successive trigger signals is 10 ms. See "Triggering - Free Running" on page 23.
Sensor cannot be deactivated via the activation input	Activation Input set to "Disregard"	Use LESsoft to configure the activation input to "Regard". See "Activation" on page 75.

Table 12.1: General causes of errors

12.2 Interface error

Error	Possible error cause	Measures
No connection Yellow LED not illuminated	Wiring error	Check Ethernet cable.
No connection Yellow LED not illuminated	DHCP activated in network, no fixed or alternate network address assigned	Assign alternate IP address, see "Establish connection to PC" on page 60.
	Incorrect IP address/subnet mask set on LES	Check IP address/subnet mask, IP addresses of LES and control must be different , subnet mask however must be the same , see table 8.1 "Address allocation in the Ethernet" on page 60.
	Incorrect port assigned to LES / control	Using ping command check whether the sensor responds. If so, check port assignment to LES and control. The set ports must match.
	Firewall blocks ports	Switch off firewall temporarily and repeat connection test.

Table 12.2: Interface error

12.3 Error messages in display (starting from firmware V01.40)

Only 1 error can be shown in the display. In the event of an error, the first line of the display shows an error message and the second line displays a plain-text message.

Error: 01001
Supply Volt.

Error	Possible error cause	Measures
Error: 001xx, 005xx, 006xx	EMC interference	Check wiring, shield sensor.
Error: 00302, 00309, 00402, 00403	Ambient temperature too high	Select installation space with a lower temperature.
Error: 01000	Supply voltage when switching on too high	Check supply voltage.
Error: 01001	Supply voltage when switching on too low	Check supply voltage.
Output Overload	Short-circuit on output, EMC interference	Check wiring, shield sensor.

Table 12.3: Error messages in display



Notice!

If deviating error messages occur, contact your Leuze distributor or service organization.

⚡ Please disconnect the sensor from the supply voltage and eliminate the cause of the error.

If a short-circuit occurs on the output, the following is displayed:

Output Overload
Reset -> Enter

⚡ Please eliminate the cause of the error.



Notice!

Acknowledging the error with the "Enter" button on the membrane keyboard causes a software reset of the sensor. During this time, the sensor is not ready - this can be seen at: X1 pin 4: Out Ready and Ethernet protocol: "Status".

The sensor starts automatically and is then ready again. An Ethernet connection must be re-established.

**Notice!**

Please use **chapter 12 as a master copy** should servicing be required.

- ✦ Please cross the items in the "Measures" column that you have already examined, fill out the following address field, and fax the pages together with your service contract to the fax number listed below or send the information via e-mail.

Customer data (please complete)

Device type:	
Serial number:	
Firmware version:	
Configuration software version:	
Display on OLED display:	
Company:	
Contact partner / department:	
E-mail address:	
Phone (direct):	
Fax:	
Street / No:	
ZIP code/City:	
Country:	

Have the following information ready for the service department:

- File: LESsoft.1os (located in the installation directory of **LESsoft**)

Leuze Service fax number:

+49 7021 573 - 199

Leuze Service e-mail:

service.detect@leuze.de

13 Maintenance

13.1 General maintenance information

Usually, the light section sensor does not require any maintenance by the operator.

Cleaning

In the event of dust buildup, clean the LES with a soft cloth; use a cleaning agent (commercially available glass cleaner) if necessary.



Notice!

Do not use aggressive cleaning agents such as thinner or acetone for cleaning the light section sensors. Use of improper cleaning agents can damage the optical window.

13.2 Repairs, servicing

Repairs to the device must only be carried out by the manufacturer.

- ✉ *Contact your Leuze distributor or service organization should repairs be required. The addresses can be found on the inside of the cover and on the back.*



Notice!

When sending light section sensors to Leuze electronic for repair, please provide an accurate description of the error.

13.3 Disassembling, packing, disposing

Repacking

For later reuse, the device is to be packed so that it is protected.



Notice!

Electrical scrap is a special waste product! Observe the locally applicable regulations regarding disposal of the product.

14 Specifications

14.1 General specifications

Optical data	LES 36...	LES 36HI...
Measurement range ¹⁾ in Z direction	200 ... 800mm	200 ... 600 mm
Light source	laser	
Wavelength	658nm (visible red light)	
Max output power	< 8mW	
Pulse duration	3ms	
Laser line	600 x 3 mm at 800mm	approx. 170 x 1.5 mm at 600 mm
Error limits (relative to measurement distance)		
Resolution ^{2) 3)} in X direction in Z direction	1 ... 1.7mm 1 ... 3mm	0.2 ... 0.6mm 0.1 ... 0.9mm
Linearity in Z -direction ³⁾	≤ ±1 %	
Repeatability in Z -direction ³⁾	≤ 0,5 %	
B/w detection thresholds	≤ 1 % (6 ... 90 % diffuse reflection)	
Object detection		
Minimum object size in x direction ⁴⁾	2 ... 3mm	0.6 ... 2mm
Minimum object size in z direction ²⁾	2 ... 6mm	0.4 ... 3mm
Timing		
Measurement time	10ms	
Delay before start-up	approx. 1.5s	
Electrical data		
Operating voltage U_B ⁵⁾	18 ... 30VDC (incl. residual ripple)	
Residual ripple	≤ 15 % of U_B	
Open-circuit current	≤ 200mA	
Ethernet interface	UDP	
Switching outputs	1 (ready) / 100mA / push-pull on X1 ⁶⁾ 1 (cascading) / 100mA / push-pull on X1 ⁶⁾ 4 / 100mA / push-pull on X3 ^{6) 7)} (only LES 36/VC6 and LES 36HI/VC6)	
Inputs	1 (trigger) on X1 1 (activation) on X1 3 (selection of inspection task) on X3 ⁸⁾ (LES 36/VC6 and LES 36HI/VC6)	
Signal voltage high/low	≥ ($U_B - 2V$) ≤ 2V	
Analog output (LES 36/VC6, LES 36HI/VC6)		
Analogue output	voltage 1 ... 10V, $R_L \geq 2k\Omega$ current 4 ... 20mA, $R_L \leq 500\Omega$	

PROFIBUS (only LES 36/PB and LES 36HI/PB)		
Interface type	1 x RS 485 on X4	
Protocols	PROFIBUS DP/DPV1 slave	
Baud rate	9.6kBaud ... 6MBaud	
Indicators		
Green LED	continuous light	ready
	off	no voltage
Yellow LED	continuous light	Ethernet connection available
	flashing	Ethernet data transmission active
	off	no Ethernet connection available
Mechanical data		
Housing	aluminum frame with plastic cover	
Optics cover	glass	
Weight	620g	
Connection type	M12 connector	
Environmental data		
Ambient temp. (operation/storage)	-30°C ... +50°C/-30°C ... +70°C	
Protective circuit ⁹⁾	1, 2, 3	
VDE safety class	III, protective extra-low voltage	
Protection class	IP 67	
Laser class	2M (according to EN 60825-1 and 21 CFR 1040.10 with Laser Notice No. 50)	
Standards applied	IEC/EN 60947-5-2, UL 508	

- 1) Luminosity coefficient 6% ... 90%, entire measurement range, at 20°C after 30minutes warmup time, medium range U_B
- 2) Minimum and maximum value dependent on the measurement distance, at 20°C after 30min. warmup time, average range U_B , z-resolution at factory setting median "3"
- 3) Reflectivity 90%, identical object, identical environment conditions, measurement object $\geq 20 \times 20 \text{mm}^2$
- 4) Minimum value, depends on distance and object, requires testing under application conditions
- 5) For UL applications: for use in class 2 circuits according to NEC only
- 6) The push-pull switching outputs must not be connected in parallel
- 7) Number of detection fields: up to 16 with logic operation option
- 8) Number of inspection tasks: up to 16 (8 of these can be activated via inputs)
- 9) 1=transient protection, 2=polarity reversal protection, 3=short circuit protection for all outputs, requires external protective circuit for inductive loads

14.2 Typical measurement range

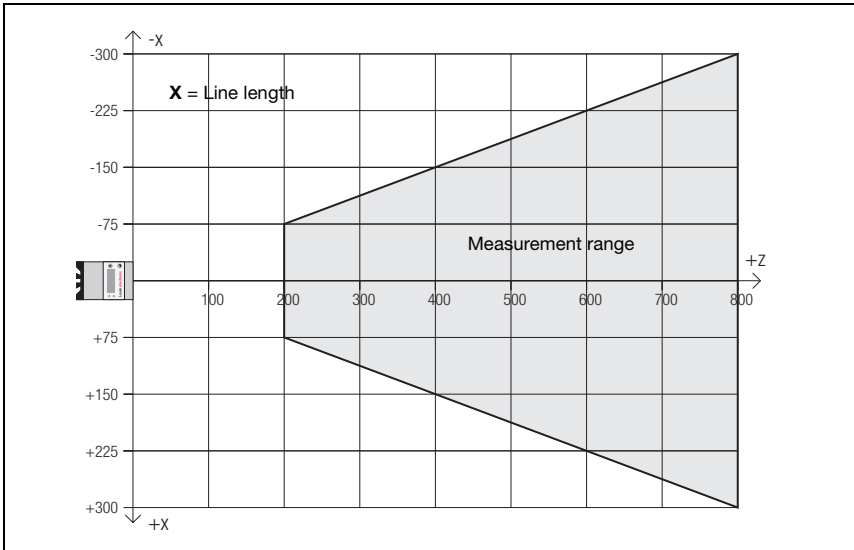


Figure 14.1: Typical measurement range LES 36

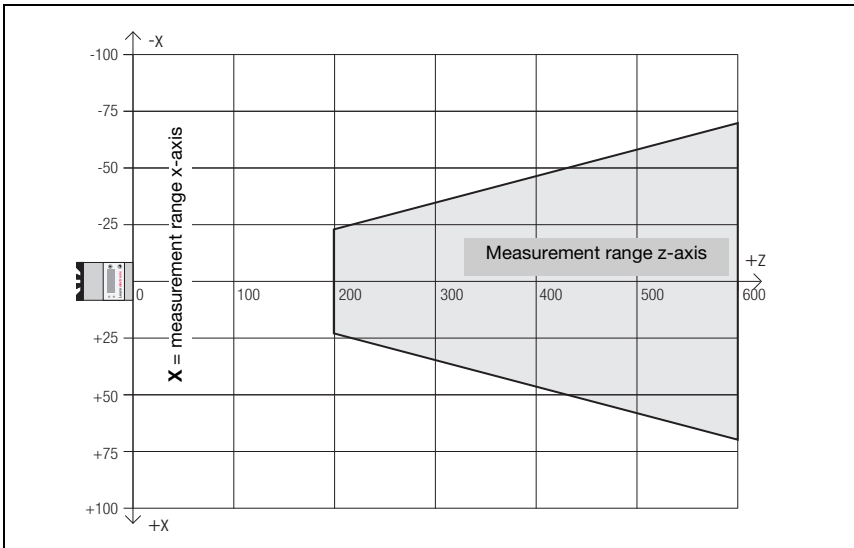


Figure 14.2: Typical measurement range LES 36HI

14.3 Dimensioned drawing

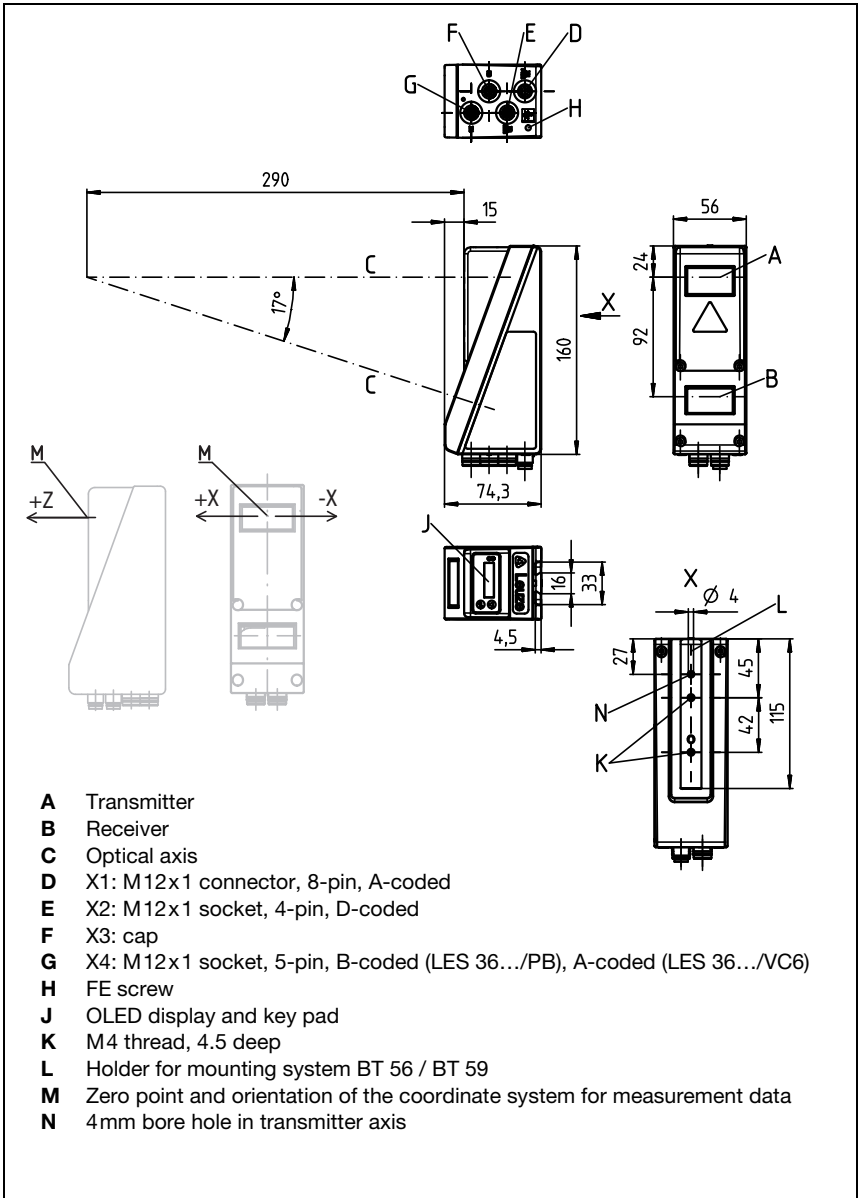


Figure 14.3: Dimensioned drawing LES

15 Type overview and accessories

15.1 Type overview

15.1.1 LPS

Type designation	Description	Part no.
LPS 36/EN	Line profile sensor for profile generation, measurement range 200 ... 800 mm, line length 600 mm with Ethernet interface, incremental encoder connection	50111324
LPS 36	Line profile sensor for profile generation, measurement range 200 ... 800 mm, line length 600 mm with Ethernet interface	50111325
LPS 36 HI/EN	Line profile sensor for profile generation, measurement range 200 ... 600 mm, line length 140 mm with Ethernet interface, incremental encoder connection	50111334

Table 15.1: Type overview LPS

15.1.2 LRS

Type designation	Description	Part no.
LRS 36/6	Line profile sensor for product detection (also multi-track), detection range 200 ... 800 mm, line length 600 mm, Ethernet interface, 4 switching outputs for detection information, 3 switching inputs for selection of the inspection task	50111330
LRS 36/6.10	Line profile sensor for product detection (also multi-track), detection range 200 ... 800 mm, line length 600 mm, Ethernet interface, 4 switching outputs for detection information, 3 switching inputs for selection of the inspection task, model with plastic screen	50115418
LRS 36/PB	Line profile sensor for product detection (also multi-track), detection range 200 ... 800 mm, line length 600 mm, Ethernet interface, PROFIBUS DP	50111332

Table 15.2: Type overview LRS

15.1.3 LES

Type designation	Description	Part no.
LES 36/PB	Line profile sensor for edge detection (also multi-track), detection range 200 ... 800 mm, line length 600 mm, Ethernet interface, PROFIBUS DP	50111327
LES 36HI/PB	Line profile sensor for edge detection (also multi-track), detection range 200 ... 600 mm, line length 140 mm, Ethernet interface, PROFIBUS DP	50111331

Table 15.3: Type overview LES

Type designation	Description	Part no.
LES 36/VC6	Line profile sensor for edge detection and object measurement (also multi-track), detection range 200 ... 800 mm, line length 600 mm, Ethernet interface, analog current or voltage output, 4 switching outputs for detection information, 3 switching inputs for selection of the inspection task	50111333
LES 36HI/VC6	Line profile sensor for edge detection and object measurement (also multi-track), detection range 200 ... 600 mm, line length 140 mm, Ethernet interface, analog current or voltage output, 4 switching outputs for detection information, 3 switching inputs for selection of the inspection task	50111329

Table 15.3: Type overview LES

15.2 Accessories

15.2.1 Fastening

Mounting devices

Type designation	Description	Part no.
BT 56	Mounting device featuring dovetail for rod	500 27375
BT 59	Mounting device featuring dovetail for ITEM profile	50111224

Table 15.4: Mounting devices for the LES

15.2.2 Accessories - Ready-made cables for voltage supply X1

Contact assignment for connection cable X1

Connection cable X1 (8-pin socket, A-coded)			
	Pin	Name	Core color
<p>M12 socket (A-coded)</p>	1	VIN	WH
	2	InAct	BN
	3	GND	GN
	4	OutReady	YE
	5	InTrig	GY
	6	OutCas	PK
	7	Do not connect!	BU
	8	Do not connect!	RD

Table 15.5: K-D M12A-8P... cable assignments

Order codes of cables for voltage supply

Type designation	Description	Part no.
M12 socket for X1, axial connector, open cable end		
K-D M12A-8P-2m-PUR	Cable length 2m	50104591
K-D M12A-8P-5m-PUR	Cable length 5m	50104590
K-D M12A-8P-10m-PUR	Cable length 10m	50106882
CB-M12-15000E-8G	Cable length 15m	678062
CB-M12-25000E-8G	Cable length 25m	678063
CB-M12-50000E-8G	Cable length 50m	678064

Table 15.6: X1 cables for the LES

15.2.3 Accessories for Ethernet interface X2

Ready-made cables with M12 plug/open cable end

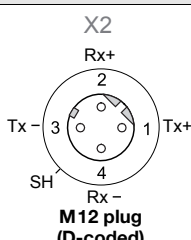
M12 Ethernet connection cables (4-pin plug, D-coded, open cable end)				
 <p>M12 plug (D-coded)</p>	Name	Pin (M12)	Core color	
	Tx+	1	YE	
	Rx+	2	WH	
	Tx-	3	OR	
	Rx-	4	BU	
	SH	shield (thread)	-	

Table 15.7: Pin assignments KB ET-...-SA

Type designation	Description	Part no.
M12 plug for X2, axial connector, open cable end		
KB ET - 2000 - SA	Cable length 2m	50106739
KB ET - 5000 - SA	Cable length 5m	50106740
KB ET - 10000 - SA	Cable length 10m	50106741
KB ET - 15000 - SA	Cable length 15m	50106742
KB ET - 30000 - SA	Cable length 30m	50106746

Table 15.8: Ethernet connection cables featuring M12 plug/open cable end

Ready-made cables with M12 plug/RJ-45 plug

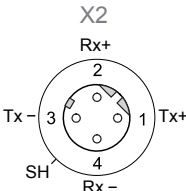
M12 Ethernet connection cables (4-pin plug, D-coded, M12 to RJ-45)				
 <p>M12 plug (D-coded)</p>	Name	Pin (M12)	Core color	Pin (RJ-45)
	Tx+	1	YE	1
	Rx+	2	WH	3
	Tx-	3	OR	2
	Rx-	4	BU	6
	SH	shield (thread)	-	

Table 15.9: Pin assignments KB ET-...-SA-RJ45

Type designation	Description	Part no.
M12 plug for X2 to RJ-45 plug		
KB ET - 2000 - SA-RJ45	Cable length 2m	50109880
KB ET - 5000 - SA-RJ45	Cable length 5m	50109881
KB ET - 10000 - SA-RJ45	Cable length 10m	50109882
KB ET - 15000 - SA-RJ45	Cable length 15m	50109883
KB ET - 30000 - SA-RJ45	Cable length 30m	50109886

Table 15.10: Ethernet connection cables M12 connector/RJ-45

Ready-made cables with M12 plug/M12 plug

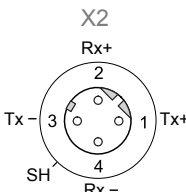
M12 Ethernet connection cables (4-pin plug, D-coded, on both sides)				
 <p>M12 plug (D-coded)</p>	Name	Pin (M12)	Core color	Pin (M12)
	Tx+	1	YE	1
	Rx+	2	WH	2
	Tx-	3	OR	3
	Rx-	4	BU	4
	SH	shield (thread)	-	shield (thread)

Table 15.11: Pin assignments KB ET-...-SSA

Type designation	Description	Part no.
M12 plug + M12 plug for X2		
KB ET - 2000 - SSA	Cable length 2m	50106899
KB ET - 5000 - SSA	Cable length 5m	50106900
KB ET - 10000 - SSA	Cable length 10m	50106901
KB ET - 15000 - SSA	Cable length 15m	50106902
KB ET - 30000 - SSA	Cable length 30m	50106905

Table 15.12: Ethernet connection cables featuring M12 plug/M12 plug

Connectors

Type designation	Description	Part no.
D-ET1	RJ45 plug for user-configuration	50108991
KDS ET M12 / RJ 45 W - 4P	Converter from M12 D-coded to RJ 45 socket	50109832

Table 15.13: Connectors for the LES

15.2.4 Accessories - Ready-made cables for X3 (only LES 36.../VC6)

Contact assignment for X3 connection cables

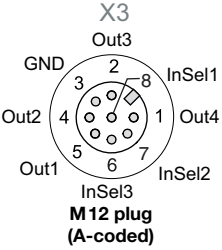
X3 (8-pin plug, A-coded)			
	Pin	Name	Core color
 <p>M 12 plug (A-coded)</p>	1	Out4	WH
	2	Out3	BN
	3	GND	GN
	4	Out2	YE
	5	Out1	GY
	6	InSel3	PK
	7	InSel2	BU
	8	InSel1	RD

Table 15.14: Pin assignments KB M12/8-...-SA

Order codes of connection cables for X3

Type designation	Description	Part no.
M 12 plug for X3, axial connector, open cable end, shielded up to 10m		
KB M12/8-2000-SA	Cable length 2m	50110179
KB M12/8-5000-SA	Cable length 5m	50110180
KB M12/8-10000-SA	Cable length 10m	50110181

Table 15.15: X3 cables for the LES 36.../VC6

15.2.5 Connection accessories / ready-made cables for X4 (only LES 36.../PB)

Contact assignment for X4 connection cables

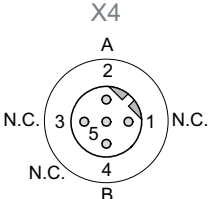
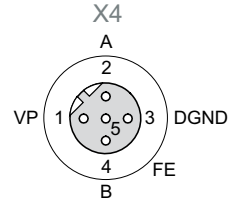
X4 (5-pin connector, B-coded)			
	Pin	Name	Remark
 <p>M12 connector (B-coded)</p>	1	N.C.	–
	2	A	Receive/transmit data RxD/TxD-N, green
	3	N.C.	–
	4	B	Receive/transmit data RxD/TxD-P, red
	5	N.C.	–
 <p>M12 socket (B-coded)</p>	Thread	FE	Functional earth (housing)

Table 15.16: Pin assignment X4 (PROFIBUS)

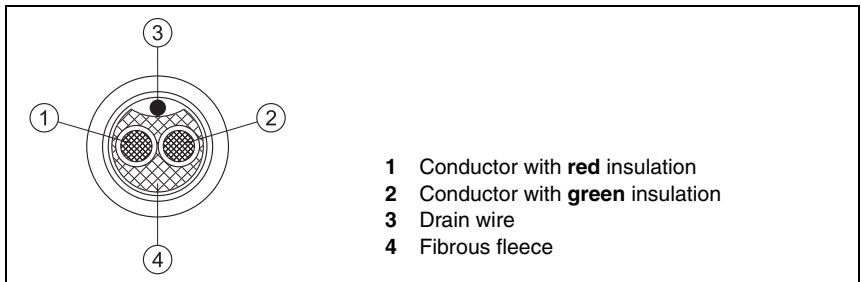


Figure 15.1: Cable structure for PROFIBUS connection cables

Order codes of connection accessories for X4

Type designation	Description	Part no.
Terminator plug for PROFIBUS bus termination		
TS 02-4-SA	M12 terminating resistor for PROFIBUS	50038539
PROFIBUS T-connector		
KDS BUS OUT M12-T-5P	M12 T-connector for BUS OUT	50109834

Table 15.17: PROFIBUS connection accessories for the LES 36.../PB

Order codes of PROFIBUS connection cables for X4

Type designation	Description	Part no.
KB PB-2000-BA	M12 socket for BUS IN, axial connector, open cable end, cable length 2m	50104181
KB PB-5000-BA	M12 socket for BUS IN, axial connector, open cable end, cable length 5m	50104180
KB PB-10000-BA	M12 socket for BUS IN, axial connector, open cable end, cable length 10m	50104179
KB PB-2000-SA	M12 socket for BUS OUT axial connector, open cable end, cable length 2m	50104188
KB PB-5000-SA	M12 socket for BUS OUT axial connector, open cable end, cable length 5m	50104187
KB PB-10000-SA	M12 socket for BUS OUT axial connector, open cable end, cable length 10m	50104186
KB PB-2000-SBA	M12 connector + M12 socket for PROFIBUS, axial connectors, cable length 2m	50104097
KB PB-5000-SBA	M12 connector + M12 socket for PROFIBUS, axial connectors, cable length 5m	50104098
KB PB-10000-SBA	M12 connector + M12 socket for PROFIBUS, axial connectors, cable length 10m	50104099

Table 15.18: PROFIBUS cables for LES 36.../PB

15.2.6 Connection accessories / ready-made cables for X4 (only LES 36.../VC6)

Contact assignment for X4 connection cables

X4 (5-pin socket, A-coded)			
	Pin	Name	Remark
<p>X4 4-20mA</p> <p>n. c. 1 2 3 AGND 4 FE 1-10V</p> <p>M12 socket (A-coded)</p>	1	N.C.	–
	2	4-20mA	Analog current output
	3	AGND	–
	4	1-10V	Analog voltage output
	5	FE	Functional earth
<p>X4 4-20mA</p> <p>AGND 3 2 1 n. c. 4 FE 1-10V</p> <p>M12 plug (A-coded)</p>	Thread	FE	Functional earth (housing)

Table 15.19: Pin assignment X4

Order codes of connection cables for X4 (only LES 36.../VC6)

Type designation	Description	Part no.
KB 008-3000 A-S	M12 plug for X4, axial connector, open cable end, shielded, UL, 3m cable length	50101941
KB 008-5000 A-S	M12 plug for X4, axial connector, open cable end, shielded, UL, 5m cable length	50102969
KB 008-10000 A-S	M12 plug for X4, axial connector, open cable end, shielded, UL, 10m cable length	50102971

Table 15.20: Connection cables for LES 36/VC6, LES 36HI/VC6

15.2.7 Configuration memory

Type designation	Description	Part no.
K-DS M12A-8P-0.75m-LxS36-CP	Configuration memory for LxS 36 light section sensors	50125541

Table 15.21: Configuration memory for LxS 36

The configuration memory for the LxS 36 light section sensors is connected to connection X1 and extends the existing connection cable to the voltage supply (see chapter 15.2.2). The configuration memory saves the configured inspection tasks as well as the setting of general parameters such as operating mode, activation, cascading, detection range (FoV), etc., from the connected sensor and transfers these to a new device following an exchange.

16 Appendix

16.1 Glossary

Activation input	Input for switching the laser beam on/off. There is no exact time allocation between the application/removal of the signal and the switch-on/off time.
Alignment aid	Visualization of the Z-coordinates on the display: the measurement values at the left edge, in the center and at the right edge of the laser line extending along the X-axis are displayed. It is designed to align the light emission area of the laser parallel to the conveying belt.
Analysis Window (AW)	Rectangular area of the LES in which objects are detected. An object is only detected if the number of object measurement points (current hits) is greater than or equal to the defined minimum number of measurement points (Hits On).
Exposure	Time span of light striking the CMOS receiver, while being reflected off the object to be detected.
File	Task set, which can be stored or accessed via the user interface of the PC or the control.
Display	Display/Control panel directly at the sensor.
Detection range (Field of view - FOV)	The detection range is defined via configuration software. Without changing the predefined range it extends trapezoidally according to the maximum detection range specifications. If the maximum detection range is not required to solve the application task, it is recommended to reduce the detection range to a minimum.
Inspection task	All settings for the application are made in the configuration software and are stored in up to 16 inspection tasks. It is possible to easily adapt to different tasks by changing over the inspection task.
IP address	Address in network
Edge Analysis Window (EAW)	Rectangular area of the LES in which the edges are detected and analyzed. An edge is only detected if the number of successive measurement points (Current Sequent Hits Left /Right) is greater than or equal to the defined minimum number of measurement points (Sequent Hits). Edge analysis windows can also be used for object detection.
Cascading	Triggered series connection of several sensors. A master sensor takes over the control (synchronization) of up to 9 slaves.
Measurement time	Time between two individual measurements.
Object	Medium to be detected by sensor.
Offline	LESsoft is operated without sensor.
Online	LESsoft is operated with sensor.

Profile	Distance and position progression of one or more measurements, coordinates of the respective X/Z-values when passing through the laser beam along the x-axis.
Profile data	
2D view	Graphical presentation of the X/Z-coordinate values of an object within the detection range.
Trigger	Triggering one or more measurement processes with precise time allocation.
UDP	Standardized connectionless Ethernet protocol, Layer 4.

16.2 Revision History / Feature list

16.2.1 Firmware

Firmware	Function range	Meaning	Required configuration software
Beginning with V01.10	Multiple inspection tasks for the LPS 36	Up to 16 different configurations can be stored in the sensor; switch between configurations by means of a command	LxSsoft V1.20 (LPSsoft V1.20, LRSsoft V1.04)
Beginning with V01.20	Optimized encoder interface	LPS 36/EN: single-channel encoders are also supported, encoder options, new factory settings	LxSsoft V1.20 (LPSsoft V1.20, LRSsoft V1.10)
	Deactivation of data output - X-coordinates	LPS 36: reduction of data quantity (useful for PLC evaluation)	
	Extension of the transmission pause between the Z- and X-data packets	LPS 36: improved reading of data packets (useful for PLC evaluation)	
	Ethernet trigger	Reduction of data quantity (useful for PLC evaluation), reduction in cabling	
Beginning with V01.25	PROFIBUS support	other LRS 36/PB device types with PROFIBUS	LxSsoft V1.30 (LPSsoft V1.30, LRSsoft V1.20)
	Ethernet sensor activation	Activation now possible via Ethernet Reduction in cabling	
	Factory setting - analysis depth 1 for LRS 36	LRS 36: the maximum detection rate can be achieved with this setting.	
Beginning with V01.30	Supports LES 36	Additional device types LES 36/ PB with PROFIBUS and LES 36/ VC with analog output	LxSsoft V1.40 (LPSsoft V1.33, LESsoft V1.10, LRSsoft V1.20)

Table 16.1: Revision History - Firmware

Beginning with V01.40	Support of LPS 36HI/EN	Additional device types LPS 36HI/EN	LxSsoft V2.00 (LPSsoft V2.00, LESsoft V1.10, LRSsoft V1.20)
	New "Ethernet Activation" command	Switching on laser via Ethernet command	
	New "Get/Set Single Inspection Task Parameter" commands	Parameter adjustment via Ethernet commands without LPSsoft	
	Display of error numbers on display	Fast detection of the cause of the error	
	Extension of the maximum cable lengths	Maximum cable length 50m	
Beginning with V01.41	Additional operator control possibility at the sensor	Inspection task selection via the control panel of the sensor	LxSsoft V2.30 (LPSsoft V2.20, LESsoft V2.30, LRSsoft V2.20)
	Supports LES 36/VC6, LES 36HI/VC6	Additional device types LES 36/VC6, LES 36HI/VC6	
	Relative window positioning of LES		
Beginning with V01.50	Ethernet default gateway, destination port number	IP address for default gateway and destination port number can be set	LESsoft V2.40
	New menu structure	More clearly arranged structure of the operating menu	

Table 16.1: Revision History - Firmware

16.2.2 Configuration software

Version	Function range	Meaning
LxSsoft V1.20 (LPSsoft V1.20, LRSsoft V1.04)	Installer for LPSsoft and LRSsoft	Simple installation, "Accept" button in LRSsoft
LPSsoft V1.30, LRSsoft V1.10	Trigger operation is also supported while configuration software is running	LRS 36, LPS 36: optimized diagnosis in trigger operation
	Display of encoder counter value	LRS 36/EN: visualization encoder
	New: Encoder parameters	LRS 36/EN: encoder interface configuration: single-/multi-channel encoder, overflow values, reversal of direction of rotation
LxSsoft V1.30 (LPSsoft V1.30, LRSsoft V1.20)	Support of the other LRS 36/PB device types with PROFIBUS	Configuration of PROFIBUS settings and LRS 36/PB
LxSsoft V1.40 (LPSsoft V1.33, LESsoft V1.10, LRSsoft V1.20)	Support of the additional device types LES 36/PB with PROFIBUS and LES 36/VC with analog output	Configuration of LES 36 device variants

Table 16.2: Revision History - Configuration software

LxSsoft V1.41 (LPSsoft V1.33, LESsoft V1.10, LRSsoft V1.20)	Installer for Windows 7	Software runs with the 32 and 64 bit version of Windows 7
LxSsoft V2.00 (LPSsoft V2.00, LESsoft V1.10, LRSsoft V1.20)	Support of additional LPS 36Hi/EN device types	Configuration of LPS 36Hi/EN
LxSsoft V2.30 (LPSsoft V2.20, LESsoft V2.30, LRSsoft V2.20)	Import Inspection Task Edit Analysis Windows - Position Type	Settings of individual inspection tasks can be imported from a saved LES project Edge Analysis Windows can be positioned relatively and can thus track object movement.
LxSsoft V2.31 (LPSsoft V2.31, LESsoft V2.31, LRSsoft V2.31)	Also supports LES 36/VC6 device type Documentation updated	
LxSsoft V2.40 (LPSsoft V2.40, LESsoft V2.40, LRSsoft V2.40)	Configuration and saving of the IP address of the default gateway and the destination port number	The IP address of the default gateway and the destination port number can now be configured and saved in the parameter set.
LxSsoft V2.41 (LPSsoft V2.40, LESsoft V2.41, LRSsoft V2.40)	Also supports LES 36Hi/PB device type	

Table 16.2: Revision History - Configuration software

Index

Numbers

2D profile data 16

A

Activation 23
 Activation input 22, 46, 75
 Alignment 39
 Alignment aid 40, 53

C

Cables for encoder connection 134
 Cables for PROFIBUS connection 135
 Cables for the analog output 137
 Cables for voltage supply 131
 Cascading output 47, 75
 CAT 5 cable 47
 Causes of errors 121
 Cleaning 40, 125
 Command mode 94
 Commissioning 22, 62
 Connectors 134
 Coordinate system 40

D

Detection mode 94
 Disposal of packaging material 35
 Disposing 125

E

Electrical connection 41
 Electrical data 126
 Encoder count 96
 Environment variable 69
 Environmental data 127
 Error limits 126
 Error message 69
 Ethernet cable assignment 47
 Ethernet connection 70
 Ethernet interface 132
 Exposure duration 75
 Exposure setting 75

F

Factory setting 59
 Fastening groove 36
 Firewall 94

G

Glare 22
 GSD file 111, 113

I

Indicators 127
 Interface version 42
 IP address 61
 ITEM profile 38

L

Laser occlusion 17, 18
 Laser Radiation 39
 Line Profile Sensor 22
 Local Area Connection 61

M

Maintenance 125
 Measure mode 94
 Measurement range 75, 128
 Mechanical data 127
 Mechanical design 22
 Menu navigation 58
 Menu structure 55
 Module 113
 Mounting devices 131
 Mounting location 39
 Mutual interference 24

N

Name plate 35

O

Occlusion 17
 OLED display 52
 Optical data 126

P

Performance features	20
Pin assignment	41
Pin assignment X1	46
Pin assignment X2	47
Pin assignment X3	48
Pin assignment X4	49, 50, 135
Port 9008	60
Power supply	46
PROFIBUS	111
Address assignment	112
GSD file	111, 113
Input data	115
Inputs	113
Measurement frequency	117, 119, 120
Module	113, 117
Output data	114
Outputs	113
Parameter	113
Slave	111

R

Receiver occlusion	17, 18
Receiving optics	16
Repair	125
Resolution	19
Rod installation	37

S

Servicing	125
Shielding	43, 47
System requirements	63
System variable	69

T

Termination	135
Timing	126
Triangulation principle	16
Trigger input	46, 74
Trigger time	23
Troubleshooting	121
Type overview	130

U

UDP	60
-----	----

W

Warmup time	60
-------------	----