



HRT 96

Diffuse reflection light scanner with background suppression



Dimensioned drawing

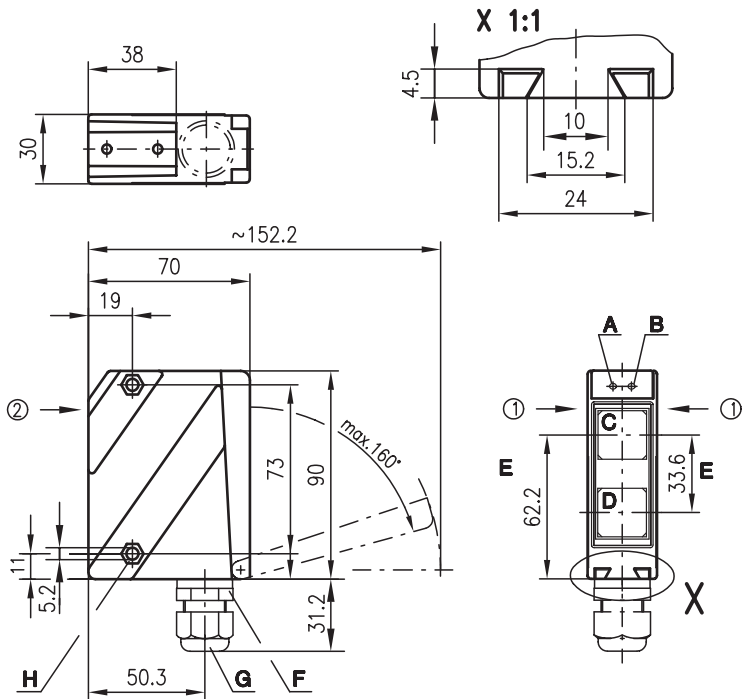

100 ... 1800mm
100 ... 1200mm



- Scanner with adjustable background suppression in visible red light or infrared light
- Robust metal housing with glass cover or plastic housing, protection class IP 67/ IP 69K for industrial application
- Complementary outputs, scanning range adjustment and delay before start-up for optimal adaptation to the application
- Connection via M12 connector or terminal compartment
- Multiple options with switching delays, activation input and optics heating for use at low temperatures

- A Indicator diode green
 - B Indicator diode yellow
 - C Transmitter
 - D Receiver
 - E Optical axis
 - F Device plug M12x1
 - G Screwed cable gland M16x1.5 for Ø 5 ... 10mm
 - H Countersinking for SK nut M5, 4.2 deep
 - I Connection terminals
 - K Cable entry
 - L Scanning range adjustment
- Preferred entry direction for objects ① + ②

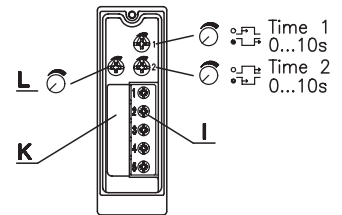

Electrical connection

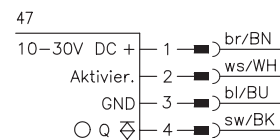
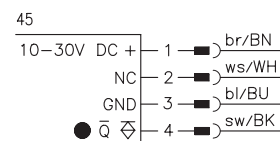
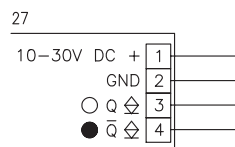
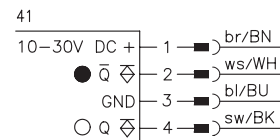
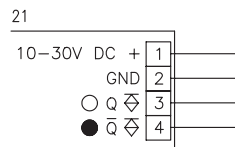

Accessories:

- (available separately)
- Mounting systems (BT 96, BT 96.1, UMS 96, BT 450.1-96)
 - M12 connectors (KD ...)
 - Ready-made cables (K-D ...)

We reserve the right to make changes • 96_d01e.fm



Specifications

Optical data

Typ. scanning range limit (white 90%) ¹⁾
 Scanning range ²⁾
 Adjustment range
 Light source
 Wavelength

Infrared light

100 ... 1800mm
 see tables
 150 ... 1200mm
 LED (modulated light)
 880nm

Red light

100 ... 1200mm
 see tables
 100 ... 800mm
 LED (modulated light)
 660nm

Timing

Switching frequency 300Hz
 Response time 1.67ms
 Delay before start-up ≤ 200ms

Electrical data

Operating voltage U_B 10 ... 30VDC (incl. residual ripple)
 Residual ripple ≤ 15% of U_B
 Bias current ≤ 35mA, ≤ 75mA with optics heating
 Switching output PNP transistor
 Function characteristics light or dark switching (reversible)
 Signal voltage high/low ≥ ($U_B - 2V$) / ≤ 2V
 Output current max. 100mA

Indicators

LED green ready
 LED yellow reflection

Mechanical data

Housing diecast zinc
 Optics cover glass
 Weight 380g
 Connection type terminals or M12 connector

Environmental data

Ambient temp. (operation/storage) -20°C ... +60°C / -40°C ... +70°C
 Protective circuit ³⁾ 1, 2, 3, 4
 VDE safety class ⁴⁾ II, all-insulated
 Protection class IP 67, IP 69K ⁵⁾
 LED class 1 (acc. to EN 60825-1)
 Standards applied IEC 60947-5-2

Options

Optics heating for temperature changes, prevents fogging
Low temperature to -35°C
Switching delay (slow oper./release) 0 ... 10s (separately adjustable)
Activation input activ
 Transmitter active/not active ≥ 8V / ≤ 2V
 Activation/disable delay ≤ 0.5ms
 Input resistance 47KΩ ± 10%

- 1) Typ. scanning range limit: max. attainable range without performance reserve
- 2) Scanning range: recommended range with performance reserve
- 3) 1=transient protection, 2=polarity reversal protection, 3=short circuit protection for all outputs, 4=interference blanking
- 4) Rating voltage 250VAC
- 5) IP 69K test acc. to DIN 40050 part 9 simulated, high pressure cleaning conditions without the use of additives, acids and bases are not part of the test

Remarks

- With the set scanning range, a tolerance of the upper scanning range limit is possible depending on the reflection properties of the material surface.
- The diffuse reflection light scanner is also available with integrated AS-i chip for direct connection to the AS-i system.

Order guide

Selection table		Order code →									
Equipment ↓		HRT 96MP-1630-800-41 Part No. 500 80047	HRT 96MP-1636-800-41 Part No. 500 32127	HRT 96MP-1640-800-21 Part No. 500 25124	HRT 96MP-1640-800-41 Part No. 500 25126	HRT 96MP-1635-800-45 Part No. 501 04142	HRT 96MP-1610-1200-21 Part No. 500 25116	HRT 96MP-1610-1200-41 Part No. 500 25118	HRT 96MP-1620-1200-21 Part No. 500 25114	HRT 96MP-1620-1200-41 Part No. 500 61102	HRT 96MN-1606-1200-27 Part No. 500 40358
Light source	red light (800mm)	●	●	●	●	●					
	infrared light (1200mm)						●	●	●	●	●
Connection	terminals			●			●		●		●
	M12 connector	●	●		●	●		●		●	
Features	optics heating/low temp.		●						●	●	●
	switching delay			●	●		●	●	●	●	
	activation input										
	NPN switching output										●
	for AS-i I/O coupling modules					●					

Tables

Red light

1	100	800	1200
2	100	770	1140
3	100	730	1050

Infrared light

1	100	1200	1800
2	100	1100	1600
3	100	1000	1350

1	white 90%
2	grey 18%
3	black 6%

□ Scanning range [mm]
 ■ Typ. scanning range limit [mm]

Diagrams

Red light

Typ. response behaviour (white 90%)

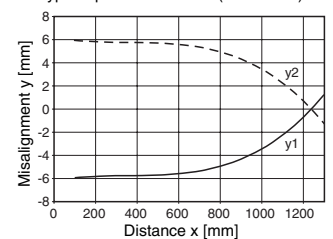

Infrared light

Typ. response behaviour (white 90%)

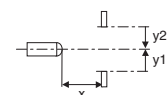
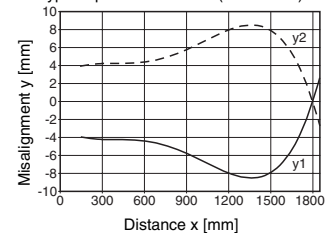

Red light

Typ. black/white behaviour

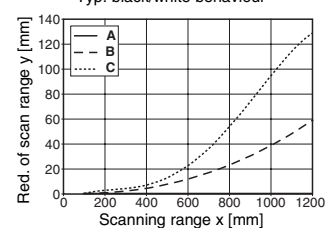

Infrared light

Typ. black/white behaviour

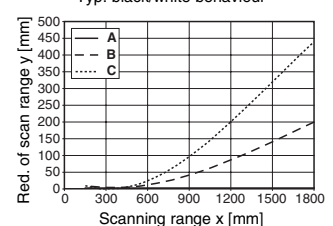

- A white 90%
- B grey 18%
- C black 6%

