

HRT 96

Diffuse reflection light scanner with background suppression

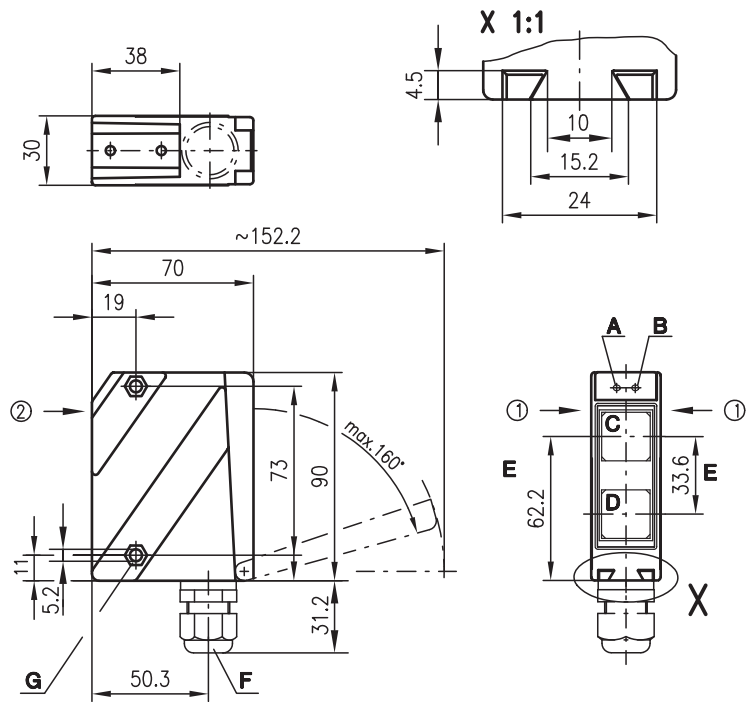

Dimensioned drawing



- A** Green indicator diode
 - B** Yellow indicator diode
 - C** Transmitter
 - D** Receiver
 - E** Optical axis
 - F** Screwed cable gland M16x1.5 for Ø 5 ... 10mm
 - G** Countersinking for SK nut M5, 4.2 deep
 - H** Connection terminals
 - I** Cable entry
 - K** Scanning range adjustment
- Preferred entry direction for objects ① + ↘

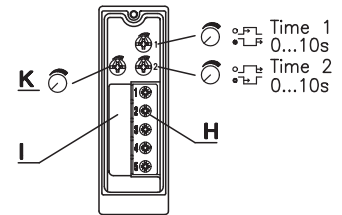

Electrical connection

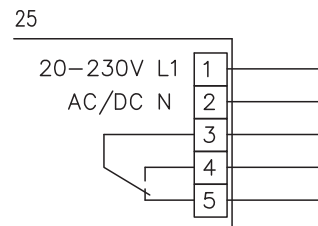

en 10-2012/08 50120808

We reserve the right to make changes • DS_HRT96MKR120025_en_50120808.fm

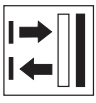

100 ... 1800mm



- Scanner with adjustable background suppression in infrared light
- Robust metal housing with glass cover or plastic housing, protection class IP 67/ IP 69K for industrial application
- All-mains design 20 ... 230VAC/DC with relay output
- Relay with change-over contact, scanning range adjustment and delay before start-up for optimal adaptation to the application
- Connection via comfortable terminal compartment up to 1.5mm²
- Version with additional switching delay



Accessories:

(available separately)

- Mounting systems (BT 96, BT 96.1, UMS 96, BT 450.1-96)
- Spark extinction

Specifications

Optical data

Typ. scanning range limit (white 90%) ¹⁾
 Scanning range ²⁾
 Adjustment range
 Light source
 Wavelength

Infrared light

100 ... 1800mm
 see tables
 150 ... 1200mm
 LED (modulated light)
 880nm (infrared)

Timing

Switching frequency 20Hz
 Response time 25ms
 Delay before start-up ≤ 200ms

Electrical data

Operating voltage U_B
 20 ... 230VAC, 50/60Hz
 20 ... 230VDC
 ≤ 1.5VA
 Power consumption
 Switching output ³⁾
 relay, 1 change-over contact
 Function characteristics
 break-contact/make-contact
 Switching voltage, relay
 250VAC/DC
 Switching current, relay
 250VAC, 3A/30VDC, 3A
 Switching power, relay
 750VA, $\cos\phi=1$

Indicators

Green LED
 Yellow LED
 ready
 reflection

Mechanical data

Housing
 Optics cover
 Weight
 Connection type

Metal housing

diecast zinc
 glass
 380g
 terminals

Plastic housing

polycarbonate
 plastic
 150g
 terminals

Environmental data

Ambient temp. (operation/storage) -30°C ... +60°C/-40°C ... +70°C
 Protective circuit ⁴⁾
 1, 4
 VDE safety class ⁵⁾
 II, all-insulated
 Protection class IP 67, IP 69K ⁶⁾ IP 67
 Light source Exempt group (in acc. with EN 62471)
 Standards applied IEC 60947-5-2

Options

Switching delay (slow oper./release) 0 ... 10s (separately adjustable)

- 1) Typ. scanning range limit: max. attainable range without performance reserve
- 2) Scanning range: recommended range with performance reserve
- 3) Suitable spark extinction must be provided with inductive or capacitive loads
- 4) 1=transient protection, 4=interference blanking
- 5) Rating voltage 250VAC
- 6) IP 69K test acc. to DIN 40050 part 9 simulated, high pressure cleaning conditions without the use of additives, acids and bases are not part of the test

Tables

1	100	1200	1800
2	100	1100	1600
3	100	1000	1350

1	white 90%
2	grey 18%
3	black 6%

Scanning range [mm]
 Typ. scanning range limit [mm]

Diagrams

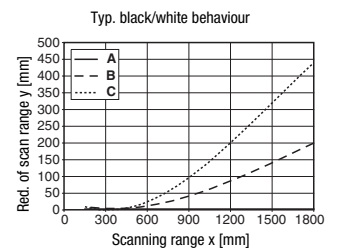
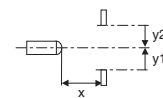
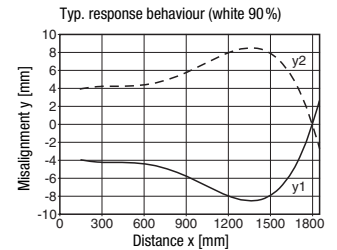

- A white 90%
- B grey 18%
- C black 6%

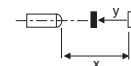

Order guide

Selection table		Order code →				
Equipment ↓		HRT 96K/R-1680-1200-25 Part no. 50025132	HRT 96K/R-1690-1200-25 Part no. 50025131	HRT 96M/R-1680-1200-25 Part no. 50080076	HRT 96M/R-1690-1200-25 Part no. 50080075	HRT 96K/R-1689-1200-25 Part no. 50081261
Housing	metal			●	●	
	plastic	●	●			●
Light source	infrared light (1200mm)	●	●	●	●	●
Connection	terminals	●	●	●	●	●
	without screwed cable gland					●
Features	switching delay		●		●	
	UL homologation			●	●	

Remarks

- **Approved purpose:**
 This product may only be used by qualified personnel and must only be used for the approved purpose. This sensor is not a safety sensor and is not to be used for the protection of persons.
- With the set scanning range, a tolerance of the upper scanning range limit is possible depending on the reflection properties of the material surface.