

PRK49C depol RELAIS Retro-reflective photoelectric sensors with polarization filter

en 01-2015/07 50129986

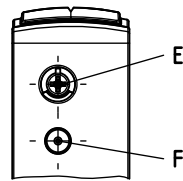

Dimensioned drawing

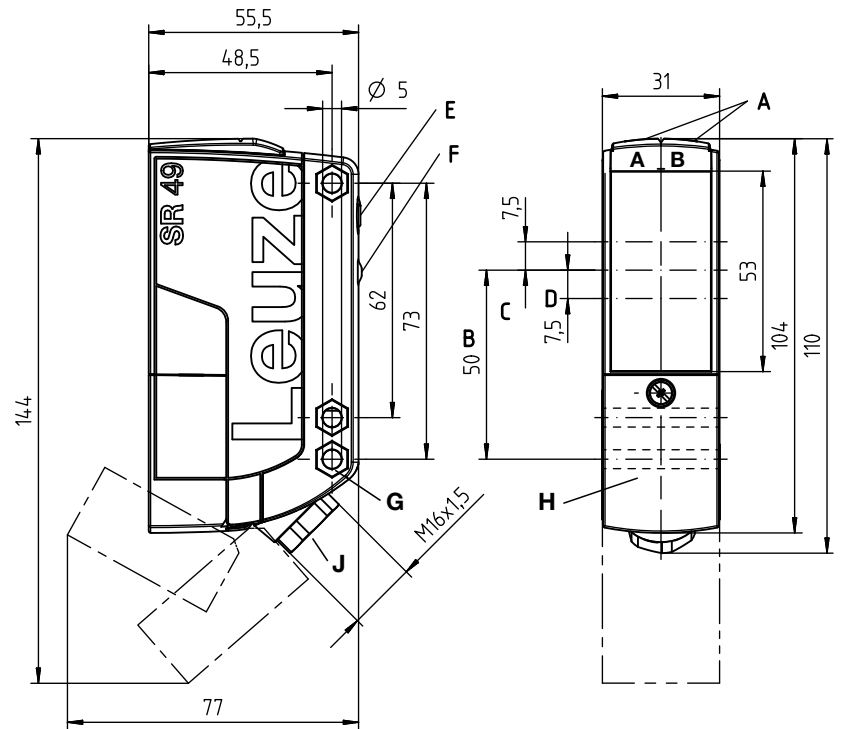

- A_A** Green indicator diode
- A_B** Yellow indicator diode
- B** Optical axis
- C** Receiver
- D** Transmitter
- E** Sensitivity adjustment
- F** Teach button for light/dark switching / time module activation
- G** Countersinking for SK nut M5, 4.2 deep
- H** Connection compartment with spring terminals
- J** Cable entry with M16x1.5 screw fitting for Ø5 ... 10mm

20m

- Polarized retro-reflective photoelectric sensor with large operating range and high performance reserve in visible red light
- Highest functional reliability, even for depolarizing media (e.g., foil packaging, shrink-wrapped packages)
- Robust plastic housing, degree of protection IP 67 and IP 69K for industrial application
- All-mains design 20 ... 250VAC/DC with relay output (potential-free)
- Sensitivity adjustment and delay before start-up for optimal adaptation to the application
- Light/dark switching and time module activation via teach button for time-saving integration in existing evaluation environment:
- Space-saving installation thanks to front access to the connection compartment
- Extremely time-saving connection by means of spring terminals (up to 1.5mm²)

Electrical connection

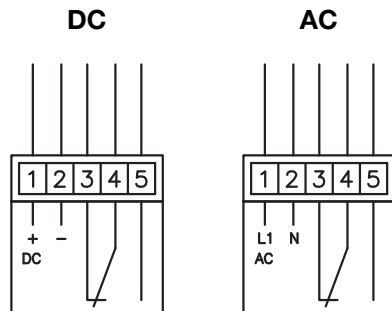

Wire color of connecting cable

Pin	Color
1	BR / BN
2	BL / BU
3	WS / WH
4	GR / GY
5	SW / BK



Accessories:

(available separately)

- Mounting systems (BTU 460, BT 96, BT 96.1, BT 450.1-96)
- Spark extinction
- Reflectors/reflective tapes

We reserve the right to make changes • DS_PRK49CUCD1TS_en_50129986.fm

Specifications

Optical data

Typ. op. range limit (TK(S) 100x100) ¹⁾	20m
Operating range ²⁾	see tables
Operating range adjustment	225° potentiometer (PRK49C.UCD1... only)
Light spot diameter	approx. 130mm at 6m
Light source	LED (modulated light)
Wavelength	630nm (visible red light)
Polarization filter	yes

Timing

Switching frequency	25Hz
Response time	20ms
Delay before start-up	≤ 300ms

Electrical data

Operating voltage U_B	20 ... 250VAC, 50/60Hz 20 ... 250VDC
Power consumption	≤ 1.5VA
Switching output ³⁾	relay, 1 change-over contact
Function	break-contact/make-contact
Switching voltage, relay	250VAC/DC
Switching current, relay	250VAC, 2.5A/30VDC, 2.5A
Switching power, relay	625VA, $\cos\phi=1$
Sensitivity	adjustable

Indicators

Green LED	ready
Yellow LED	light path free
Yellow LED, flashing	light path free, no performance reserve

Mechanical data

Housing	polycarbonate
Optics cover	plastic
Weight	150g
Connection type	spring terminals, max. wire cross section 1.5mm ² cable 2000mm, 5 x 0.5mm ²

Environmental data

Ambient temp. (operation/storage)	-40°C ... +60°C/-40°C ... +70°C
Protective circuit ⁴⁾	1, 4
VDE safety class ⁵⁾	II, all-insulated
Degree of protection	IP 67, IP 69K ⁶⁾
Light source	exempt group (in acc. with EN 62471)
Standards applied	IEC 60947-5-2

Options

Switching function (teach level 1)	light switching (factory setting) or dark switching
Time module (teach level 2)	active: dropout delay 500ms not active: no dropout delay (factory setting)
	on request

Optics heating

- 1) Typ. operating range limit: max. attainable range without performance reserve
- 2) Operating range: recommended range with performance reserve
- 3) Suitable spark extinction (snubber) must be provided with inductive or capacitive loads
- 4) 1=transient protection, 4=interference blanking
- 5) Rating voltage 250VAC
- 6) IP 69K test acc. to DIN 40050 part 9 simulated, high pressure cleaning conditions without the use of additives, acids and bases are not part of the test

Tables

Reflectors	Operating range
1 TK(S) 100x100	0.1 ... 16m
2 TK 82.2	0.4 ... 10m
3 MTKS 50x50.1	0.1 ... 10m
4 TK(S) 40x60	0.1 ... 8m
5 TK(S) 20x40	0.1 ... 4m
6 Tape 4 50x50	0.3 ... 2m

1	0.1	16	20
2	0.4	10	12
3	0.1	10	12
4	0.1	8	10
5	0.1	4	5
6	0.3	2	3

Operating range [m]
 Typ. operating range limit [m]

TK ... = adhesive
 TKS ... = screw type
 Tape 4 = adhesive

Diagrams

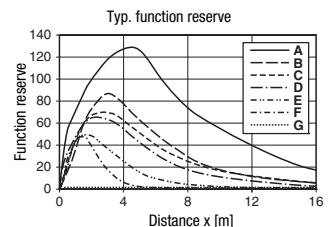
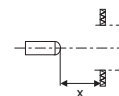
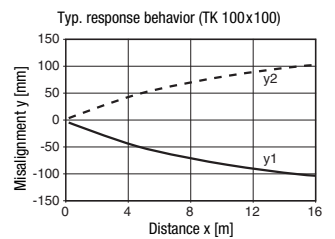

- A TK 100x100
- B TK 82.2
- C MTKS 50x50.1
- D TKS 40x60
- E TKS 20x40
- F Tape 4 50x50
- G Switching point

Remarks

Operate in accordance with intended use!

- ⚠ This product is not a safety sensor and is not intended as personnel protection.
- ⚠ The product may only be put into operation by competent persons.
- ⚠ Only use the product in accordance with the intended use.

PRK49C depol RELAIS Retro-reflective photoelectric sensors with polarization filter

Part number code

P R K 4 9 C . U C D 1 / T S - T B

Operating principle

RK Retro-reflective photoelectric sensor
PRK Retro-reflective photoelectric sensors with polarization filter

Series

49C 49C series

Light type

I Infrared light
free Red light

Operating voltage

UC 20 ... 250VAC/DC (all-mains design)

Equipment

D Depolarizing media
H Optics heating

Setting

1 Potentiometer, teach button (light/dark switching, time module activation)

Switching output

TS Relay, normally closed contact/normally open contact (NC/NO)
M4 Low-impedance MOSFET semiconductor switching output, normally open contact (NO)

Connection technology

TB Terminal block - terminal compartment with spring terminals (5 x 1.5 mm²)
free Cable 2000mm

Order guide

The sensors listed here are preferred types; current information at www.leuze.com.

All-mains designs with relay output

Designation

Part no.

Terminal compartment with spring terminals (5 x 1.5 mm²)

Red light, polarization filter, depolarizing media, potentiometer, teach button

PRK49C.UCD1/TS-TB

50127426

Cable, cable length 2m

Red light, polarization filter, depolarizing media, potentiometer, teach button

PRK49C.UCD1/TS

50127427

Teach procedure for sensor



Note

Factory setting: **light switching, time module not active**

Light/dark switching

Setting the switching behavior of the relay output

Teach level 1	<p>Press teach button (2 to 7s) until both LEDs (green/yellow) flash synchronously. Release teach button – switchover is complete.</p> <p>The yellow LED then indicates the current setting of the switching output for 3s:</p> <p>ON = light switching = output between pin 4 and pin 3: normally closed contact (NC) output between pin 4 and pin 5: normally open contact (NO)</p> <p>OFF = dark switching = output between pin 4 and pin 3: normally open contact (NO) output between pin 4 and pin 5: normally closed contact (NC)</p>	<p>2 ... 7s</p> 
----------------------	---	---

Activation/deactivation of the time module

Setting a dropout delay for the relay output

Teach level 2	<p>Press teach button (7 to 12s) until both LEDs (green/yellow) flash alternately. Release teach button – activation/deactivation is complete.</p> <p>The yellow LED then indicates the current setting of the dropout delay for 3s:</p> <p>ON = time module not active = no dropout delay for the relay</p> <p>OFF = time module active = dropout delay for the relay: 500ms ¹⁾</p> <p><small>1) Additional models on request</small></p>	<p>7 ... 12s</p> 
----------------------	--	--

Dropout delay: if the object is no longer present, the output switches with a time delay.