

ASM1, ASM1E, ASM2E

AS-i Safety Monitor



Contents

1	Einsatzbereich	7
2	Maßzeichnung	8
3	Technische Daten	9
4	Elektrische Installation	12
5	Montage	18
6	Austausch AS-i-Sicherheitsmonitor	21
7	Bestellhinweise	22
8	Bestellhinweise Zubehör	22
1	Range of application	25
2	Dimensioned drawing	26
3	Specifications	27
4	Electrical installation	30
5	Mounting	36
6	Replacing an AS-i safety monitor	39
7	Order guides	40
8	Order guides Accessories	41
1	Domaine d'utilisation	45
2	Encombrement	46
3	Caractéristiques techniques	47

4	Installation électrique	51
5	Montage	57
6	Remplacement du moniteur de sécurité AS-interface	60
7	Pour commander	61
8	Pour commander les accessoires	62
1	Campo di impiego	65
2	Disegno quotato	66
3	Dati tecnici	67
4	Installazione elettrica	71
5	Montaggio	77
6	Sostituzione del monitor di sicurezza AS-i	81
7	Per ordinare articoli	82
8	Ordinazione di accessori	83
1	Campo de aplicación	87
2	Dibujo acotado	88
3	Datos técnicos	89
4	Instalación eléctrica	93
5	Montaje	99
6	Sustitución del monitor de seguridad AS-i	102
7	Indicaciones de pedido	103
8	Instrucciones para cursar pedidos de accesorios	104

1	Toepassingsgebied	107
2	Afmetingen	108
3	Technische data	109
4	Elektrische Installatie	112
5	Montage	119
6	Wisselen van de AS-i-bewakingsmonitor	122
7	Bestelomschrijvingen	123
8	Bestelomschrijvingen accessoires	124
1	Användningsområde	127
2	Måttitning	128
3	Tekniska data	129
4	Elektrisk installation	132
5	Montering	138
6	Byte av AS-interface säkerhetsmonitorn	142
7	Beställinformation	143
8	Beställinformation tillbehör	144

Hinweise zur Benutzung der Anschluss- und Betriebsanleitung

Diese Anschluss- und Betriebsanleitung enthält Informationen über den bestimmungsgemäßen und effektiven Einsatz des AS-i Sicherheitsmonitors.

Sicherheits- und Warnhinweise sind mit dem Symbol  gekennzeichnet.

Leuze electronic GmbH + Co. KG haftet nicht für Schäden, die durch unsachgemäße Benutzung entstehen. Zur sachgerechten Verwendung gehört auch die Kenntnis dieser Anleitung.

© Nachdruck und Vervielfältigung, auch auszugsweise, nur mit ausdrücklicher Genehmigung durch:

Leuze electronic GmbH + Co. KG
Liebigstraße 4
D-82256 Fürstentfeldbruck
Telefon +49 (0) 8141 53 50-0
Telefax +49 (0) 8141 53 50-190
info@leuze.de
www.leuze.com

Diese Kurzfassung der Anschluss- und Betriebsanleitung ist Bestandteil des Lieferumfangs.



Der AS-i Sicherheitsmonitor ist nur für den Einsatz in elektrischen Betriebsräumen/Schaltschränke mit Mindestschutzart IP54 geeignet.



Zum Anschluss, Inbetriebnahme und Austausch des AS-i Sicherheitsmonitors gehört die Kenntnis der Anschluss- und Betriebsanleitung sowie des Benutzerhandbuchs der asimon-Konfigurations- und Diagnosesoftware (siehe Bestellhinweise Zubehör)



Warnung:

Gefährliche elektrische Spannung!

Kann zu elektrischem Schlag und Verbrennungen führen.

Vor Beginn der Arbeiten Anlage und Gerät spannungsfrei schalten.



Je nach Auswahl der verwendeten Sicherheitsbauteile kann die Einstufung des gesamten Sicherheitssystems auch in eine niedrigere Sicherheitskategorie erfolgen!

1 Einsatzbereich

Überwachung von per Konfigurationssoftware ASiMon zugeordneten sicherheitsgerichteten AS-i Slaves (z. B. NOT-AUS Schalter) innerhalb eines AS-i-Systems.

Je nach Gerätevariante ist der zweite Freigabekreis als sicherer AS-i Ausgang mit oder ohne Relais verfügbar.

Bei System-Vollausbau im Schutzbetrieb sicheres Abschalten mit einer Ansprechzeit von maximal 40 ms. Dabei Einbindung von bis zu 31 sicherheitsgerichteten AS-i Slaves möglich.

Mischbetrieb von Standard- und sicherheitsgerichteten AS-i Komponenten möglich.

Mehrere AS-i-Sicherheitsmonitore innerhalb eines AS-i Systems einsetzbar, die bei Bedarf gemeinsam einen sicherheitsgerichteten AS-i Slave überwachen.

Für Sicherheitsanwendungen bis Kategorie 4 nach ISO 13849-1 PLe zugelassen.



2 Maßzeichnung

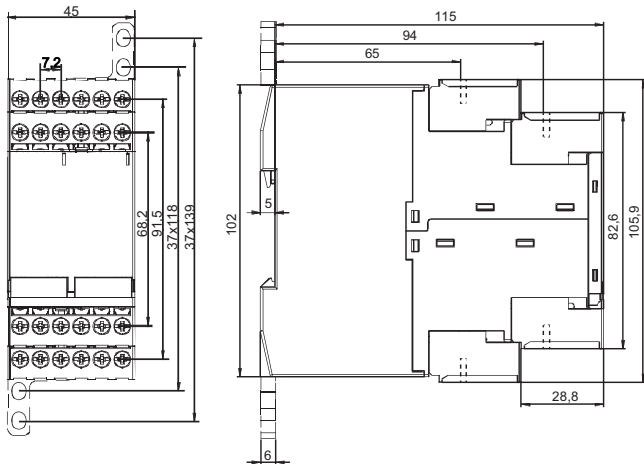

3 Technische Daten

Elektrische Daten

Betriebsspannung U_b	24V DC +/- 15%
Restwelligkeit	< 15%
Bemessungsbetriebsstrom	ASM1/1 und ASM1E/1: 150mA ASM1/2, ASM1E/2 und ASM2/1: 200mA ASM2E/2: 250mA
Einschaltspitzenstrom	alle Typen: 600mA
Reaktionszeit (sicherheits- technisch)	< 40ms
Bereitschaftsverzögerung	< 10s



AS-Interface-Daten

AS-i-Profil	Monitor 7.F
AS-i-Spannungsbereich	18,5 ... 31,6V
AS-i-Stromaufnahme	< 45mA

Mechanische Daten

Abmessungen (B x H x T)	45mm x 105mm x 120mm
Gehäusematerial	Polyamid PA 66
Gewicht	ASM1/1 und ASM1E/1: ca. 350g ASM2E/1: ca. 420g ASM1/2, ASM1E/2 und ASM2E/2: ca. 450g
Befestigung	Schnappbefestigung auf Hutschiene gemäß EN 50022

Anschluss

 Ø 5 ... 6 mm / PZ2	0,8 ... 1,2 Nm 7 ... 10.3 LB.IN
	1 x (0,5 ... 4,0) mm ² 2 x (0,5 ... 2,5) mm ²
	1 x (0,5 ... 2,5) mm ² 2 x (0,5 ... 1,5) mm ²
AWG	2 x 20 ... 14

Konfigurations-Schnittstelle

RS 232	9600 Baud, kein Parity, 1 Startbit, 1 Stopbit, 8 Datenbits
Ein- und Ausgänge Eingang "Start"	Optokopplereingang (High-aktiv), Eingangsstrom ca. 10mA bei 24V DC
Eingang "Rückführkreis" (EDM)	Optokopplereingang (High-aktiv), Eingangsstrom ca. 10mA bei 24V DC
Meldeausgang "Safety on"	PNP-Transistorausgang, 200mA, Kurzschluss- und Verpolschutz
Sicherheitsausgang	Potentialfreie Schließerkontakte, max. Kontaktbelastung: 1 A DC-13 bei 24V DC 3 A AC-15 bei 230V AC
Thermischer Dauerstrom maximal	<u>ASM1/1, ASM1E/1 und ASM2E/1:</u> maximaler Summenstrom für alle Ausgangs- schaltelemente: 6A d. h. Ausgangskreis 1: 3A je Ausgangsschalt- element <u>ASM1/2, ASM1E/2 und ASM2E/2:</u> max. Summenstrom für alle Ausgangsschalt- elemente: 8A d. h. Ausgangskreis 1: 3A je Ausgangsschalt- element Ausgangskreis 2: 1 A je Ausgangsschaltetelement oder Ausgangskreis 1: 2A je Ausgangsschaltetelement Ausgangskreis 2: 2A je Ausgangsschaltetelement
Absicherung	extern mit max. 4A MT
Überspannungskategorie	3, für Bemessungsbetriebsspannung 300V AC nach VDE 0110 Teil 1
Umgebungsdaten	
Betriebstemperatur	-20 ... +60°C
Lagertemperatur	-30 ... +70°C
Schutzart	IP 20



Achtung!

Halten Sie die vorgeschriebene Absicherung unbedingt ein, nur so ist ein sicheres Abschalten im Fehlerfall gewährleistet.



Achtung!

- Zusätzlich zur Systemreaktionszeit von max. 40ms müssen noch die Reaktionszeiten des sicheren AS-Interface-Sensor-Slaves, des zur Überwachung verwendeten Sensors, des sicheren AS-Interface-Aktor-Slaves und des dafür verwendeten Aktors addiert werden.
 Bitte beachten Sie, dass durch die Parametrierung des Sicherheitsmonitors ebenfalls zusätzliche Reaktionszeiten hervorgerufen werden können.
- Es addieren sich die Systemreaktionszeiten der verketteten AS-Interface Komponenten bei Kopplung von AS-Interface-Netzen.

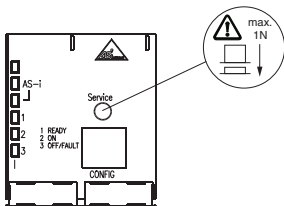

4 Elektrische Installation



Achtung!

Elektrische Installation nur von eingewiesenem Fachpersonal durchführen.



Achtung!

Jeder sicherheitsgerichtete AS-Interface Slave ist mindestens einmal pro Jahr zu betätigen und das Schaltverhalten ist durch Beobachtung der Ausgangskreise des AS-Interface Sicherheitsmonitors zu kontrollieren.

Nach Austausch eines sicherheitsgerichteten AS-i Slaves muß die korrekte Funktion des neuen Slaves, bei Austausch eines AS-i Sicherheitsmonitors die korrekte Funktion des neuen AS-i Sicherheitsmonitors überprüft werden.

Versorgungs-, Signalleitungen und auch AS-i-Busleitung getrennt von Kraftstromleitungen verlegen.

Im Schaltschrank bei Schützen eine entsprechende Funkenlöschung verwenden.

Bei Antriebsmotoren und -bremsen auf die Installationshinweise in den entsprechenden Bedienungsanleitungen achten.

Maximale Leitungslänge für die AS-i-Busleitung 100 m. Für darüber hinausgehende Leitungslängen AS-i-Repeater einsetzen.



Achtung!

Das AS-Interface-Netzteil zur Versorgung der AS-Interface-Komponenten muss eine sichere Netztrennung gemäß IEC 60742 aufweisen und kurzzeitige Netzausfälle bis zu 20 ms überbrücken. Das Netzteil zur 24 V Versorgung muss ebenfalls eine sichere Netztrennung gemäß IEC 60742 aufweisen und kurzzeitige Netzausfälle bis zu 20 ms überbrücken.

LED Anzeigen ASM

LED	Farbe	Bedeutung
AS-i 1	aus	Keine Versorgung
	grün, dauerleuchtend	AS-Interface-Versorgung vorhanden
AS-i 2	aus	Normaler Betrieb
	rot, dauerleuchtend	Kommunikationsfehler
AS-iS 1	aus	Keine Versorgung
	grün, dauerleuchtend	AS-Interface-Versorgung vorhanden
AS-iS 2	aus	Normaler Betrieb
	rot, dauerleuchtend	Kommunikationsfehler
1 READY (je Ausgangskreis)	aus	–
	gelb, dauerleuchtend	Anlauf-/Wiederanlaufsperr aktiv
	gelb, blinkend	externer Test erforderlich / Quittierung / Einschaltverzögerung aktiv
2 ON (je Ausgangskreis)	aus	Kontakte des Ausgangsschaltelements offen
	grün, dauerleuchtend	Kontakte des Ausgangsschaltelements geschlossen
	grün, blinkend	Verzögerungszeit läuft bei Stoppkategorie 1
3 OFF/ FAULT (je Ausgangskreis)	aus	Kontakte des Ausgangsschaltelements geschlossen
	rot, dauerleuchtend	Kontakte des Ausgangsschaltelements offen
	rot, blinkend	Fehler auf Ebene der überwachten AS-Interface-Komponenten
1 READY 2 ON 3 OFF/ FAULT (je Ausgangskreis)	gleichzeitig schnell blinkend	Interner Gerätefehler, Fehlermeldung per Software asimon abfragbar



Abb. 4.0-1: LED Anzeigen im Gerät

Klemmenbelegung AS-i-Sicherheitsmonitor ASM1/1 und ASM1E/1

Klemme	Signal / Beschreibung	Elektrischer Anschluss
AS-i+	Anschluss an den AS-Interface-Bus	
AS-i-		
L+	+24V DC / Versorgungsspannung	
M	GND / Bezugserde	
FE	Funktionserde	
1.Y1	EDM 1 / Eingang Rückführkreis	
1.Y2	Start 1 / Start-Eingang	
1.13 ¹⁾	Ausgangsschaltelement 1	
1.14		
1.23 ¹⁾	Ausgangsschaltelement 2	
1.24		
1.32	Meldeausgang "Safety on"	

1) Absicherung entsprechend technischer Daten

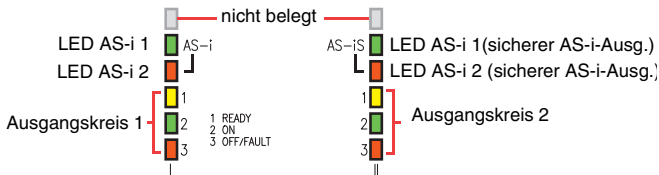
Klemmenbelegung AS-i-Sicherheitsmonitor ASM1/2 und ASM1E/2

Klemme	Signal / Beschreibung	Elektrischer Anschluss
AS-i+	Anschluss an den AS-Interface-Bus	<p>The diagram shows the terminal block with connections for L+, M, FE, AS-i+, AS-i-, and two sets of safety outputs (1 and 2). Each set includes start signals (Start 1, Start 2), two normally open contacts (K1, K2 and K3, K4), and two normally closed contacts (K5, K6 and K7, K8). The safety outputs are connected to lamps and motors (M) through relays. A 'Sensor' and 'COMF0' are also indicated on the board.</p>
AS-i-		
L+	+24V DC / Versorgungsspannung	
M	GND / Bezugserde	
FE	Funktionserde	
1.Y1	EDM 1 / Eingang Rückführkreis, Ausgangskreis 1	
1.Y2	Start 1 / Start-Eingang, Ausgangskreis 1	
1.13 ¹⁾	Ausgangsschaltelement 1, Ausgangskreis 1	
1.14		
1.23 ¹⁾	Ausgangsschaltelement 2, Ausgangskreis 1	
1.24		
1.32	Meldeausgang 1 "Safety on", Ausgangskreis 1	
2.Y1	EDM 2 / Eingang Rückführkreis, Ausgangskreis 2	
2.Y2	Start 2 / Start-Eingang, Ausgangskreis 2	
2.13 ¹⁾	Ausgangsschaltelement 1, Ausgangskreis 2	
2.14		
2.23 ¹⁾	Ausgangsschaltelement 2, Ausgangskreis 2	
2.24		
2.32	Meldeausgang 2 "Safety on", Ausgangskreis 2	

1) Absicherung entsprechend technischer Daten

Klemmenbelegung AS-i-Sicherheitsmonitor ASM2E/1 und ASM2E/2

Klemme	Signal / Beschreibung	Elektrischer Anschluss
AS-i+	Anschluss an den AS-Interface-Bus	
AS-i-		
AS-iS+	sicherer AS-Interface-Ausgang zur Aktor-Überwachung oder Kopplung eines anderen AS-Interface-Netzes	
AS-iS-		
L+	+24V DC / Versorgungsspannung	
M	GND / Bezugs Erde	
FE	Funktionserde	
1.Y1	EDM 1 / Eingang Rückführkreis, Ausgangskreis 1	
1.Y2	Start 1 / Start-Eingang, Ausgangskreis 1	
1.13 ¹⁾	Ausgangsschaltelement 1, Ausgangskreis 1	
1.14		
1.23 ¹⁾	Ausgangsschaltelement 2, Ausgangskreis 1	
1.24		
1.32	Meldeausgang 1 "Safety on", Ausgangskreis 1	
2.Y1	EDM 2 / Eingang Rückführkreis, Ausgangskreis 2	
2.Y2	Start 2 / Start-Eingang, Ausgangskreis 2	
2.13 ¹⁾	Ausgangsschaltelement 1, Ausgangskreis 2 (nur ASM2E/2!)	
2.14		
2.23 ¹⁾	Ausgangsschaltelement 2, Ausgangskreis 2 (nur ASM2E/2!)	
2.24		
2.32	Meldeausgang 2 "Safety on", Ausgangskreis 2	

NUR ASM2E/2:

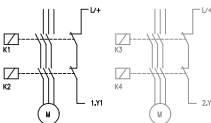

1) Absicherung entsprechend technischer Daten



Abb. 4.0-2: Anschluss bei Aktor-Überwachung



Abb. 4.0-3: Kopplung bei AS-i-Netzen

5 Montage

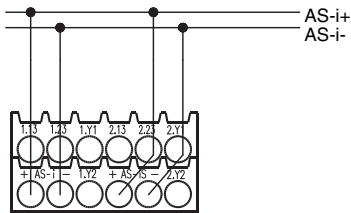
Die Montage des Sicherheitsmonitors erfolgt durch Aufklipsen auf eine Normschiene 35 mm nach EN 50022.

- Zum Entfernen den Monitor fest gegen die obere Schienenführung drücken und herausheben.

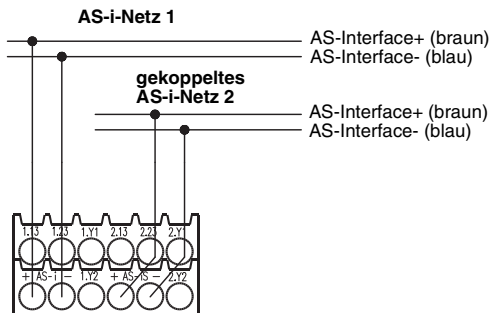

Abb. 5.0-1: Montage des Sicherheitsmonitors

- Zum Abnehmen der kodierten Anschlussklemmen Sicherungsfelder **a** wegdrücken und Klemme nach vorne wegziehen.
- Beim Aufstecken muss die Anschlussklemme mit einem Klick einrasten.



1. $U = 0 \text{ V}$
2. a, b, c, d

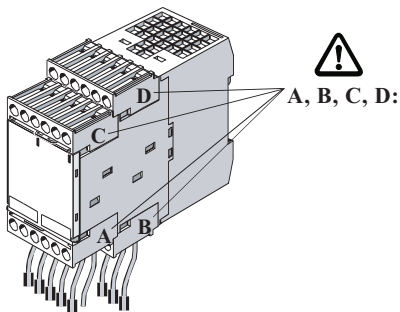

Abb. 5.0-2: Kodierte Anschlussklemmen abnehmen und aufstecken

- Abdeckkappe anbringen und plombieren in Schritten 1-5.

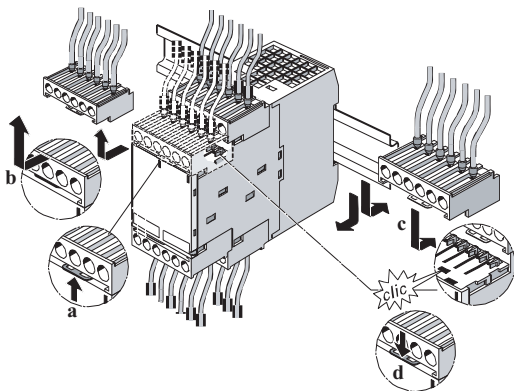
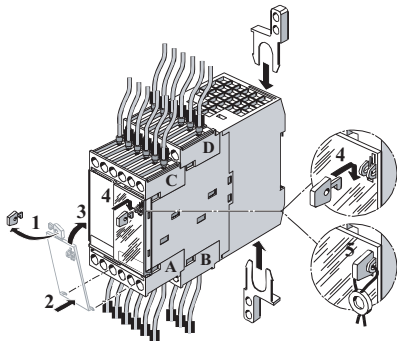

a = Plombierbare Abdeckkappe zum Sichern gegen unbefugtes Verstellen und als ESD-Schutz (Teil des Lieferumfangs).

Abb. 5.0-3: Montage und Verplombung der Abdeckkappe



Weitere Hinweise siehe Anschluss- und Betriebsanleitung AS-i Sicherheitsmonitor.

6 Austausch AS-i-Sicherheitsmonitor

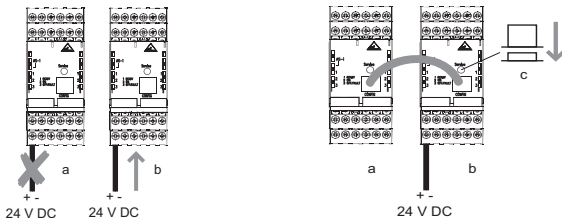

- 1 Trennen Sie den defekten (a) AS-i-Sicherheitsmonitor von der Versorgung und schließen Sie den neuen (b) an.
- 2 Verbinden Sie den defekten (a) und den neuen (b) AS-i-Sicherheitsmonitor über das Kabel RJ45/RJ45 und drücken Sie die Servicetaste (c) des neuen (b) AS-i-Sicherheitsmonitors.

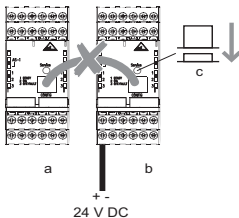

- 2 Trennen Sie die beiden AS-i-Sicherheitsmonitore und drücken Sie erneut die Servicetaste.

7 Bestellhinweise

Art.-Nr.	Artikel	Beschreibung
580020	ASM1/1	AS-i Sicherheitsmonitor, 1 Freigabekreis
580021	ASM1/2	AS-i Sicherheitsmonitor, 2 Freigabekreise
580024	ASM1E/1	AS-i Sicherheitsmonitor, 1 Freigabekreis; erw. Funktionalität
580025	ASM1E/2	AS-i Sicherheitsmonitor, 2 Freigabekreise; erw. Funktionalität
580028	ASM2E/1	AS-i Sicherheitsmonitor, 1 Freigabekreis, 1 sicherer AS-i Ausgang, erw. Funktionalität
580029	ASM2E/2	AS-i Sicherheitsmonitor, 2 Freigabekreise, 1 sicherer AS-i Ausgang, erw. Funktionalität
580055	ASM1E-m/1	AS-i Sicherheitsmonitor, 1 Freigabekreis, erw. Funktionalität, Muting
580056	ASM1E-m/2	AS-i Sicherheitsmonitor, 2 Freigabekreise, erw. Funktionalität, Muting
580057	ASM2E-m/1	AS-i Sicherheitsmonitor, 1 Freigabekreis, 1 si- cherer AS-i Ausgang, erw. Funktionalität, Muting
580058	ASM2E-m/2	AS-i Sicherheitsmonitor, 2 Freigabekreise, 1 si- cherer AS-i Ausgang, erw. Funktionalität, Muting

8 Bestellhinweise Zubehör

Art.-Nr.	Artikel	Beschreibung
580032	ASM-SWC	ASM-Inbetriebnahmeset für ASM1, ASM1E und ASM2E beinhaltet: Konfigurations- und Diagnosesoftware asimon, Anschluss- und Betriebsanleitung, Be- nutzerhandbuch Software auf CD, Programmier- kabel, Geräte austausch-Datenkabel
50104078	ASM1-PK	ASM1-Parametrierkabel
50104079	ASM1-DK	ASM1-Geräte austausch-Datenkabel

Information on the use of the connecting and operating instructions

These connecting and operating instructions contain information on the proper and effective use of the AS-i safety monitor.

Safety and warning notices are labelled with the symbol.



Leuze electronic GmbH + Co. KG is not liable for damages caused by improper use. Knowledge of these instructions is an element of proper use.

© Reprinting and duplication, including excerpts, are permissible only with the express approval of:

Leuze electronic GmbH + Co. KG
Liebigstrasse 4
82256 Fuerstenfeldbruck / Germany
Phone +49 8141 53 50-0
Telefax +49 8141 53 50-190
info@leuze.de
www.leuze.com

This short version of the connecting and operating instructions is part of the delivery contents.



The AS-i safety monitor is only suitable for use in electrical operating rooms / switch cabinets with minimum protection class IP54.



The connection, commissioning and replacement of the AS-i safety monitor requires knowledge of the connecting and operating instructions as well as of the user manual for the asimon configuration and diagnostics software (see accessories order guide).



Warning:

Dangerous electrical voltage!

May result in electrical shock and burns.

Before beginning work, disconnect the system and device from voltage.



Depending on the safety components selected for use, the complete safety system may be classified as belonging to a lower safety category!



1 Range of application

Monitoring of safe AS-i slaves (e.g. emergency-shutdown switches) within an AS-i system as assigned with the ASiMon configuration software.

Depending on the device variant, the second OSSD is available as safe AS-i output with or without relay.

For full system expansion in protective operation, safe shutdown with a response time of maximum 40 ms. It is possible here to integrate up to 31 safe AS-i slaves.

Mixed operation of standard and safe AS-i components is possible.

Multiple AS-i safety monitors can be used within an AS-i system; if necessary, they can together monitor a safe AS-i slave.

Approved for safety applications up to Category 4 acc. to ISO 13849-1 PL_e.

2 Dimensioned drawing

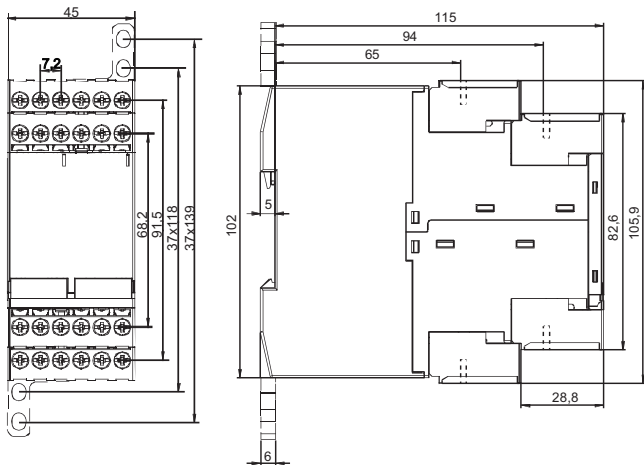

3 Specifications

Electrical data

Operating voltage U_b	24V DC +/- 15%	
Residual ripple	< 15%	
Rated operating current	ASM1/1 and ASM1E/1:	150mA
	ASM1/2, ASM1E/2 and ASM2/1:	200mA
	ASM2E/2:	250mA
Peak switch-on current	All types: 600mA	
Reaction time (safety-relevant)	< 40ms	
Delay before start-up	< 10s	



AS-interface data

AS-i profile	Monitor 7.F
AS-i voltage range	18.5 ... 31.6V
AS-i current consumption	< 45mA

Mechanical data

Dimensions (WxHxD)	45 mm x 105 mm x 120 mm
Housing material	Polyamide PA 66
Weight	ASM1/1 and ASM1E/1: approx. 350g
	ASM2E/1: approx. 420g
	ASM1/2, ASM1E/2 and ASM2E/2: approx. 450g
Mounting	Snap-on mounting on top-hat rail acc. to EN 50022

Connection

 Ø 5 ... 6 mm / PZ2	0,8 ... 1,2 Nm 7 ... 10.3 LB.IN
	1 x (0,5 ... 4,0) mm ² 2 x (0,5 ... 2,5) mm ²
	1 x (0,5 ... 2,5) mm ² 2 x (0,5 ... 1,5) mm ²
AWG	2 x 20 ... 14

Configuration interface

RS 232

9600 baud, no parity, 1 start bit, 1 stop bit, 8 data bits

Inputs and outputs

"Start" input

Optical coupling input (high active),
input current approx. 10mA at 24V DC

Input of "external device monitoring circuit" (EDM)

Optical coupling input (high active),
input current approx. 10mA at 24V DC

Message output

PNP transistor output, 200mA,
short-circuit and polarity-reversal protection

"safety on"

Potential-free make contact,

Safety output

max. contact load: 1 A DC-13 at 24V DC
3 A AC-15 at 230V AC

Continuous thermal current (max.)

ASM/1, ASM1E/1 and ASM2E/1:

max. total current for all output switching elements: 6A

i.e. output circuit 1: 3A per output switching element

ASM/2, ASM1E/2 and ASM2E/2:

max. total current for all output switching elements: 8A

i.e. output circuit 1: 3A per output switching element

output circuit 2: 1A per output switching element

or output circuit 1: 2A per output switching element

output circuit 2: 2A per output switching element

Safeguarding

External with max. 4A slow blow

Overvoltage category

3, for rated operating voltage 300V AC
acc. to VDE 0110 part 1**Environmental data**

Operating temperature

-20 ... +60°C

Storage temperature

-30 ... +70°C

Protection class

IP 20



Attention!

Be certain to maintain the specified safeguards; only in this way is safe shutdown ensured in the case of failure.



Attention!

- In addition to the system reaction time of max. 40ms, the reaction times of the safe AS-interface sensor slave, of the sensor being used for monitoring, of the safe AS-interface actuator slave and of the actuator used for this purpose must still be added. Please note that additional reaction times may likewise arise through the configuration of the safety monitor.
- The system reaction times of the daisy-chained AS-interface components are added up when coupling AS-interface networks.

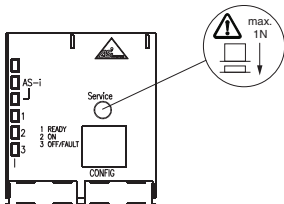

4 Electrical installation



Attention!

Electrical installation may only be performed by trained specialist technicians.



Attention!

Each safe AS-interface slave is to be activated at least once per year and the switching behaviour of the output circuits of the AS-interface safety monitor visually inspected.

After replacing a safe AS-i slave, the new slave must be checked for proper function; after replacing an AS-i safety monitor, the new AS-i safety monitor must be checked for proper function.

Supply lines, signal lines and the AS-i bus line are to be laid separately from power supply lines.

Suitable spark extinction must be used with contactors in the switch cabinet.

For drive motors and brakes, observe the installation notices in the corresponding operating instructions.

Maximum line length for the AS-i bus line is 100 m. For longer line lengths, use AS-i repeaters.



Attention!

The AS-interface power supply unit for supplying the AS-interface components must demonstrate safe mains separation acc. to IEC 60742 and the ability to bridge brief mains failures of up to 20ms. The power supply unit for 24 V supply must also demonstrate safe mains separation acc. to IEC 60742 and the ability to bridge brief mains failures of up to 20ms.

LED indicators ASM

LED	Colour	Meaning
AS-i 1	off	no supply
	green, continuous	AS-interface supply present
AS-i 2	off	normal operation
	red, continuous	communication error
AS-iS 1	off	no supply
	green, continuous	AS-interface supply present
AS-iS 2	off	normal operation
	red, continuous	communication error
1 READY (per output circuit)	off	–
	yellow, continuous	start-up/restart-disable active
	yellow, flashing	external test necessary / acknowledgement / delay before start-up active
2 ON (per output circuit)	off	contacts of the output switching element open
	green, continuous	contacts of the output switching element closed
	green, flashing	delay time runs in event of Stop Category 1
3 OFF/ FAULT (per output circuit)	off	contacts of the output switching element closed
	red, continuous	contacts of the output switching element open
	red, flashing	error on level of the monitored AS-interface components
1 READY 2 ON 3 OFF/ FAULT (per output circuit)	simultaneously flashing rapidly	internal device error, error message can be queried by means of asimon software

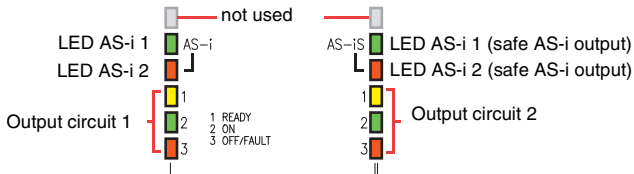

Fig. 4.0-1: LED indicators in the device

Terminal assignments of AS-i safety monitors ASM1/1 and ASM1E/1

Terminal	Signal / description	Electrical connection
AS-i+	Connection to the AS-interface bus	
AS-i-		
L+	+24V DC / supply voltage	
M	GND / reference ground	
FE	Functional earth	
1.Y1	EDM 1 / input of external device monitoring circuit	
1.Y2	Start 1 / start input	
1.13 ¹⁾	Output switching element 1	
1.14		
1.23 ¹⁾	Output switching element 2	
1.24		
1.32	Message output "safety on"	

1) Safeguard according to technical data

Terminal assignments of AS-i safety monitors ASM1/2 and ASM1E/2

Terminal	Signal / description	Electrical connection
AS-i+	Connection to the AS-interface bus	
AS-i-		
L+	+24V DC / supply voltage	
M	GND / reference ground	
FE	Functional earth	
1.Y1	EDM 1 / input of external device monitoring circuit, output circuit 1	
1.Y2	Start 1 / start input, output circuit 1	
1.13 ¹⁾	Output switching element 1, output circuit 1	
1.14		
1.23 ¹⁾	Output switching element 2, output circuit 1	
1.24		
1.32	Message output 1 "Safety on", output circuit 1	
2.Y1	EDM 2 / input of external device monitoring circuit, output circuit 2	
2.Y2	Start 2 / start input, output circuit 2	
2.13 ¹⁾	Output switching element 1, output circuit 2	
2.14		
2.23 ¹⁾	Output switching element 2, output circuit 2	
2.24		
2.32	Message output 2 "Safety on", output circuit 2	

1) Safeguard according to technical data

Terminal assignments of AS-i safety monitors ASM2E/1 and ASM2E/2

Terminal	Signal / description	Electrical connection
AS-i+	Connection to the AS-interface bus	
AS-i-		
AS-iS+	Safe AS-interface output for actuator monitoring or coupling of another AS-interface network	
AS-iS-		
L+	+24V DC / supply voltage	
M	GND / reference ground	
FE	Functional earth	
1.Y1	EDM 1 / input of external device monitoring circuit, output circuit 1	
1.Y2	Start 1 / start input, output circuit 1	
1.13 ¹⁾	Output switching element 1, output circuit 1	
1.14		
1.23 ¹⁾	Output switching element 2, output circuit 1	
1.24		
1.32	Message output 1 "Safety on", output circuit 1	
2.Y1	EDM 2 / input of external device monitoring circuit, output circuit 2	
2.Y2	Start 2 / start input, output circuit 2	
2.13 ¹⁾	Output switching element 1, output circuit 2 (only ASM2E/2!)	
2.14		
2.23 ¹⁾	Output switching element 2, output circuit 2 (ASM2E/2 only!)	
2.24		
2.32	Message output 2 "Safety on", output circuit 2	

ONLY ASM2E/2:

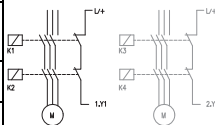

1) Safeguard according to technical data

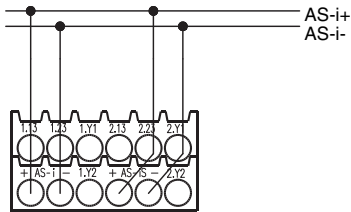

Fig. 4.0-2: Connection for actuator monitoring

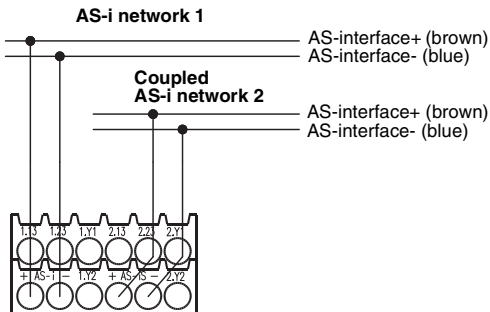

Fig. 4.0-3: Coupling for AS-i networks

5 Mounting

The safety monitor is mounted by clipping onto a standard 35 mm rail acc. to EN 50022.

- To remove, firmly press the monitor against the upper rail guide and lift out.

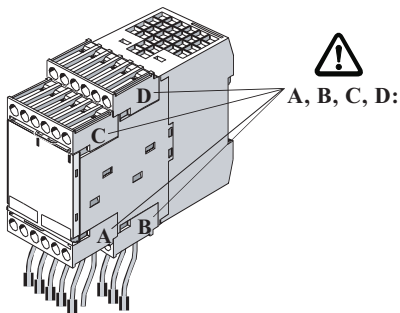

Fig. 5.0-1: Mounting the safety monitor

- To remove the encoded connection terminals, push back the safety spring **a** and pull the terminal away towards the front.
- When mounting, the connection terminal must audibly lock into place.



1. $U = 0\text{ V}$
2. a, b, c, d

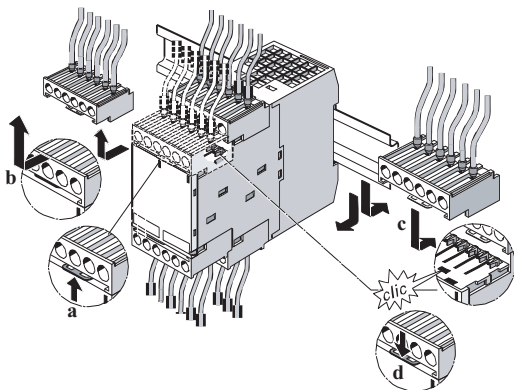
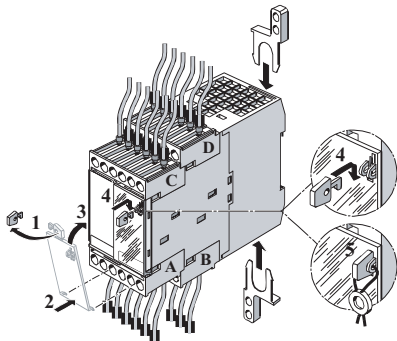

Fig. 5.0-2: Removing and mounting encoded connection terminals

- Mount cap and seal in steps 1-5.



a = Sealable cap for safeguarding against unauthorised adjustment and for ESD protection (part of the delivery contents).

Fig. 5.0-3: Mounting and sealing the cap



For further information, see the connecting and operating instructions for the AS-i safety monitor.

6 Replacing an AS-i safety monitor

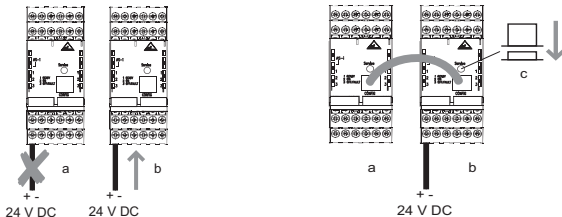

1 Disconnect the defective (a) AS-i safety monitor from the supply and connect the new monitor (b).

2 Connect the defective (a) and the new (b) AS-i safety monitor via the RJ45/RJ45 cable and press the service button (c) on the new (b) AS-i safety monitor.

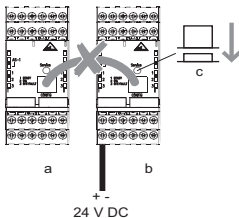

2 Disconnect the two AS-i safety monitors from one another and press the service button again.

7 Order guides

Part No.	Article	Description
580020	ASM1/1	AS-i safety monitor, 1 OSSD
580021	ASM1/2	AS-i safety monitor, 2 OSSDs
580024	ASM1E/1	AS-i safety monitor, 1 OSSD; expanded functionality
580025	ASM1E/2	AS-i safety monitor, 2 OSSDs; expanded functionality
580028	ASM2E/1	AS-i safety monitor, 1 OSSD, 1 safe AS-i output, expanded functionality
580029	ASM2E/2	AS-i safety monitor, 2 OSSDs, 1 safe AS-i output, expanded functionality
580055	ASM1E-m/1	AS-i safety monitor, 1 OSSD expanded functionality, Muting
580056	ASM1E-m/2	AS-i safety monitor, 2 OSSDs, expanded functionality, Muting
580057	ASM2E-m/1	AS-i safety monitor, 1 OSSD, 1 safe AS-i output, expanded functionality, Muting
580058	ASM2E-m/2	AS-i safety monitor, 2 OSSDs, 1 safe AS-i output, expanded functionality, Muting

8 Order guides Accessories

Part No.	Article	Description
580032	ASM-SWC	ASM commissioning set for ASM1, ASM1E and ASM2E Contains: asimon configuration and diagnostics software, connecting and operating instructions, user manual for the software on CD, configuration cable, device-replacement data cable
50104078	ASM1-PK	ASM1 configuration cable
50104079	ASM1-DK	ASM1 device-replacement data cable

Remarques relatives à l'utilisation du manuel de raccordement et d'utilisation

Ce manuel de raccordement et d'utilisation contient des informations concernant l'utilisation conforme et efficace du moniteur de sécurité AS-interface.

Les remarques de sécurité et les avertissements sont signalés par le symbole



Leuze electronic GmbH + Co. KG n'est pas responsable des dommages dus à une utilisation non conforme. L'utilisation conforme implique aussi la connaissance de ce manuel.

© Reproduction et polycopie, même par extraits, possibles seulement après accord écrit de la part de :

Leuze electronic GmbH + Co. KG
Liebigstrasse 4
82256 Fuerstenfeldbruck / Allemagne
Téléphono +49 8141 53 50-0
Telefax +49 8141 53 50-190
info@leuze.de
www.leuze.com

Cette version abrégée du manuel de raccordement et d'utilisation fait partie de la livraison.



Le moniteur de sécurité AS-interface est adapté uniquement à l'utilisation dans des locaux et armoires électriques d'indice de protection minimal IP 54.



Pour pouvoir raccorder, mettre en service et remplacer l'appareil, il est indispensable de connaître le manuel de raccordement et d'utilisation ainsi que le manuel d'utilisation du logiciel de configuration et de diagnostic asimon (voir Pour commander les accessoires).



Avertissement :

Tension électrique dangereuse !

Elle peut provoquer des décharges électriques et des brûlures.

Avant de commencer les travaux, mettre l'installation et l'appareil hors tension.



Selon les composants de sécurité choisis, le système de sécurité complet peut aussi être de catégorie de sécurité inférieure !



1 Domaine d'utilisation

Contrôle des esclaves AS-interface affectés à l'aide du logiciel de configuration ASiMon (ex. interrupteur d'arrêt d'urgence) au sein d'un système AS-interface.

Selon la variante de l'appareil, le deuxième circuit de validation est disponible comme sortie AS-interface avec ou sans relais.

Pour le système complet en mode de protection, coupure en toute sécurité avec un temps de réaction maximal de 40 ms. Ce faisant, possibilité d'intégration de jusqu'à 31 esclaves AS-interface de sécurité.

Possibilité de fonctionnement mixte de composants standard et AS-interface de sécurité.

Possibilité d'utilisation de plusieurs moniteurs de sécurité AS-interface au sein d'un système AS-interface et qui, si besoin, contrôlent ensemble un esclave AS-interface de sécurité.

Homologation pour les applications de sécurité jusqu'à la catégorie 4 conformément à ISO 13849-1 PLe.

2 Encombrement

FR

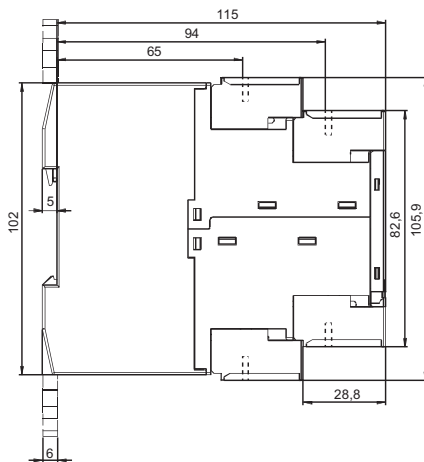
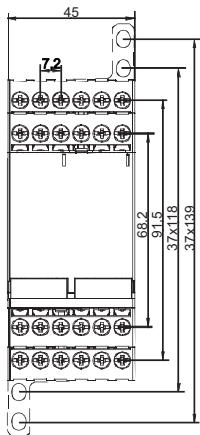

3 Caractéristiques techniques

Données électriques

Tension d'alimentation U_N	24V CC +/- 15%	
Ondulation résiduelle	< 15%	
Courant de fonctionnement de dimensionnement	ASM1/1 et ASM1E/1 : ASM1/2, ASM1E/2 et ASM2/1 : ASM2E/2 :	150mA 200mA 250mA
Courant de pointe au démarrage	tous les types : 600mA	
Temps de réaction (du point de vue de la sécurité)	< 40ms	
Temps d'initialisation	< 10s	



Caractéristiques de l'AS-interface

Profil AS-interface	moniteur 7.F
Plage de tension AS-interface	18,5 ... 31,6V
Consommation de courant AS-interface	< 45mA

Données mécaniques

Dimensions (H x L x P)	45mm x 105mm x 120mm
Matériel du boîtier	polyamide PA 66
Poids	ASM1/1 et ASM1E/1 : env. 350g ASM2E/1 : env. 420g ASM1/2, ASM1E/2 et ASM2E/2 : env. 450g
Fixation	fixation encliquetable sur profilé chapeau conforme à EN 50022

Raccordement

 Ø 5 ... 6 mm / PZ2	0,8 ... 1,2 Nm 7 ... 10.3 LB.IN
	1 x (0,5 ... 4,0) mm ² 2 x (0,5 ... 2,5) mm ²
	1 x (0,5 ... 2,5) mm ² 2 x (0,5 ... 1,5) mm ²
AWG	2 x 20 ... 14

Interface de configuration

RS 232

Entrées et sorties

Entrée « Démarrage »

Entrée Contrôle externe
(EDM)

Sortie de signalisation
« Safety on »

Sortie de sécurité

9600 Baud, pas de parité, 1 bit de départ, 1 bit
d'arrêt, 8 bits de données

entrée d'optocoupleur (active HIGH),
courant d'entrée env. 10mA sous 24V CC

entrée d'optocoupleur (active HIGH),
courant d'entrée env. 10mA sous 24V CC

sortie de transistor PNP, 200mA,
protégée contre les courts-circuits et l'inver-
sion de polarité

contacts de travail libres de potentiel,
charge max. des contacts :
1 A CC-13 sous 24V CC
3 A CA-15 sous 230V CA

Courant permanent thermique maximal	<u>ASM1/1, ASM1E/1 et ASM2E/1 :</u> courant somme maximal pour tous les éléments de commutation de sortie : 6A càd. circ. de sortie 1 : 3A par élément de commutation de sortie
	<u>ASM1/2, ASM1E/2 et ASM2E/2 :</u> courant somme maximal pour tous les éléments de commutation de sortie : 8A càd. circ. de sortie 1 : 3A par élément de commutation de sortie circuit de sortie 2 : 1A par élément de commutation de sortie ou circuit de sortie 1 : 2A par élément de commutation de sortie circuit de sortie 2 : 2A par élément de commutation de sortie
Fusibles	externes, max. 4A à action semi-retardée
Catégorie de surtension	3 pour une tension de fonctionnement de dimensionnement de 300V CA selon VDE 0110 1ère partie
Caractéristiques ambiantes	
Température de fonctionnement	-20 ... +60°C
Température de stockage	-30 ... +70°C
Indice de protection	IP 20



Attention !

Respectez impérativement les mesures de mise en sécurité prescrites, une coupure en toute sécurité n'étant pas garantie en cas de défaillance sinon.



Attention !

- Au temps de réaction système de 40ms max. s'ajoutent les temps de réaction de l'esclave capteur AS-interface sûr, du capteur utilisé pour le contrôle, de l'esclave acteur AS-interface sûr et de l'acteur utilisé pour cela.
Veuillez noter que, avec le paramétrage du moniteur de sécurité, des temps de réaction supplémentaires peuvent également être générés.
- En cas de couplage de réseaux AS-interface, les temps de réaction système des composants AS-interface enchaînés s'ajoutent.

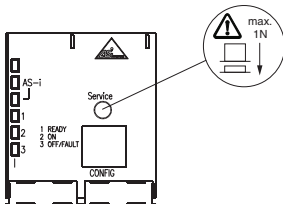

4 Installation électrique



Attention !

L'installation électrique doit toujours être effectuée par des experts initiés.



Attention !

Chacun des esclaves AS-interface de sécurité doit être actionné au moins une fois par an et le comportement de commutation contrôlé en observant les circuits de sortie du moniteur de sécurité AS-interface. Lors du remplacement d'un esclave AS-interface de sécurité, le bon fonctionnement du nouvel esclave doit être contrôlé, lors du remplacement d'un moniteur de sécurité AS-interface, celui du nouveau moniteur de sécurité AS-interface.

Poser les câbles d'alimentation, les lignes signaux et les lignes de bus AS-interface de façon à ce qu'ils soient séparés des câbles de transport de la puissance électrique.

Dans l'armoire électrique, en cas de contacteurs, utiliser un dispositif d'extinction d'étincelles adapté.

Dans les cas de moteurs et freins de commande, respecter les consignes d'installation données dans les manuels d'utilisation concernés.

Longueur maximale des lignes de bus AS-interface : 100 m. Pour des longueurs de lignes supérieures, utiliser des prolongateurs de ligne AS-interface.



Attention !

Le bloc d'alimentation AS-interface servant à l'alimentation des composants AS-interface doit posséder un système sûr de déconnexion du réseau conformément à CEI 60742 et surmonter des pannes brèves du réseau (jusqu'à 20ms). Le bloc d'alimentation 24 V doit également posséder un système sûr de déconnexion du réseau conformément à CEI 60742 et surmonter des pannes brèves du réseau (jusqu'à 20ms).

Diodes témoin ASM

DEL	Couleur	Signification
AS-i 1	éteinte	Pas d'alimentation
	verte, lum. permanente	Alimentation AS-interface présente
AS-i 2	éteinte	Fonctionnement normal
	rouge, lum. permanente	Erreur de communication
AS-iS 1	éteinte	Pas d'alimentation
	verte, lum. permanente	Alimentation AS-interface présente
AS-iS 2	éteinte	Fonctionnement normal
	rouge, lum. permanente	Erreur de communication
1 READY (par circuit de sortie)	éteinte	–
	jaune, lumière permanente	Blocage au démarrage/redémarrage actif
	jaune, clignotante	Test externe nécessaire / validation / retard au démarrage actif
2 ON (par circuit de sortie)	éteinte	Contacts de l'élément de commutation de sortie ouverts
	verte, lumière permanente	Contacts de l'élément de commutation de sortie fermés
	verte, clignotante	Temps de retard en cours si catégorie d'arrêt 1
3 OFF/ FAULT (par circuit de sortie)	éteinte	Contacts de l'élément de commutation de sortie fermés
	rouge, lumière permanente	Contacts de l'élément de commutation de sortie ouverts
	rouge, clignotante	Anomalie au niveau des composants AS-interface sous contrôle
1 READY 2 ON 3 OFF/ FAULT (par circuit de sortie)	clignotant rapidement simultanément	Erreur interne de l'appareil, message d'erreur interrogeable par logiciel asimon

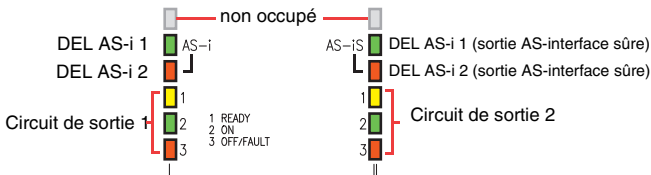

Fig. 4.0-1: Diodes témoin dans l'appareil

Affectation des bornes des moniteurs de sécurité AS-interface ASM1/1 et ASM1E/1

Borne	Signal / description	Raccordement électrique
AS-i+	Raccordement au bus AS-interface	
AS-i-		
L+	+24V CC / tension d'alimentation	
M	GND / terre de référence	
FE	Terre de fonction	
1.Y1	EDM 1 / Entrée Contrôle externe	
1.Y2	Démarrage 1 / Entrée Démarrage	
1.13 ¹⁾	Élément de commutation de sortie 1	
1.14		
1.23 ¹⁾	Élément de commutation de sortie 2	
1.24		
1.32	Sortie de signalisation « Safety on »	

1) Mise en sécurité conformément aux caractéristiques techniques

Affectation des bornes des moniteurs de sécurité AS-interface ASM1/2 et ASM1E/2

Borne	Signal / description	Raccordement électrique
AS-i+	Raccordement au bus AS-interface	<p>The diagram shows the terminal block of the ASM1/2 safety monitor. It is divided into three main sections: Power (top), Control (middle), and Safety (bottom). Power Section: L+ (+24V CC) and M (GND) terminals. A fuse is connected to L+. Start 1 and Start 2 terminals are also shown. Control Section: EDM 1, EDM 2, and a Sensor input. EDM 1 and EDM 2 are connected to relays K1 and K2. The Sensor input is connected to a sensor unit with three terminals: 1 (STOP), 2 (ON/OFF), and 3 (OFF/FAULT). Safety Section: Four relays (K3, K4) and two signal lamps. K3 and K4 are connected to the safety outputs 1.Y1 and 2.Y2. The signal lamps are connected to the safety outputs 1.32 and 2.32. Motor Connections: Two motor symbols (M) are shown at the bottom, connected to the safety outputs 1.Y1 and 2.Y2 through relays K1 and K2.</p>
AS-i-		
L+	+24V CC / tension d'alimentation	
M	GND / terre de référence	
FE	Terre de fonction	
1.Y1	EDM 1 / Entrée Contrôle externe, circuit de sortie 1	
1.Y2	Démarrage 1 / Entrée Démarrage, circuit de sortie 1	
1.13 ¹⁾	Élément de commutation de sortie 1, circuit de sortie 1	
1.14		
1.23 ¹⁾	Élément de commutation de sortie 2, circuit de sortie 2	
1.24		
1.32	Sortie de signalisation 1 « Safety on », circuit de sortie 1	
2.Y1	EDM 2 / Entrée Contrôle externe, circuit de sortie 2	
2.Y2	Démarrage 2 / Entrée Démarrage, circuit de sortie 2	
2.13 ¹⁾	Élément de commutation de sortie 2, circuit de sortie 2	
2.14		
2.23 ¹⁾	Élément de commutation de sortie 2, circuit de sortie 2	
2.24		
2.32	Sortie de signalisation 2 « Safety on », circuit de sortie 2	

1) Mise en sécurité conformément aux caractéristiques techniques

Affectation des bornes des moniteurs de sécurité AS-interface ASM2E/1 et ASM2E/2

Borne	Signal / description	Raccordement électrique
AS-i+	Raccordement au bus AS-interface	
AS-i-		
AS-iS+	Sortie AS-interface sûre pour le contrôle d'acteur ou le couplage d'un autre réseau AS-interface	
AS-iS-		
L+	+24V CC / tension d'alimentation	
M	GND / terre de référence	
FE	Terre de fonction	
1.Y1	EDM 1 / Entrée Contrôle externe, circuit de sortie 1	
1.Y2	Démarrage 1 / Entrée Démarrage, circuit de sortie 1	
1.13 ¹⁾	Élément de commutation de sortie 1, circuit de sortie 1	
1.14		
1.23 ¹⁾	Élément de commutation de sortie 2, circuit de sortie 1	
1.24		
1.32	Sortie de signalisation 1 « Safety on », circuit de sortie 1	
2.Y1	EDM 2 / Entrée Contrôle externe, circuit de sortie 2	
2.Y2	Démarrage 2 / Entrée Démarrage, circuit de sortie 2	
2.13 ¹⁾	Élément de commutation de sortie 1, circuit de sortie 2 (seulement pour l'ASM2E/2 !)	
2.14		
2.23 ¹⁾	Élément de commutation de sortie 2, circuit de sortie 2 (seulement ASM2E/2 !)	
2.24		
2.32	Sortie de signalisation 2 « Safety on », circuit de sortie 2	

SEULEMENT ASM2E/2 :

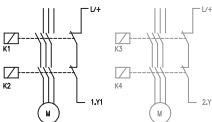

1) Mise en sécurité conformément aux caractéristiques techniques

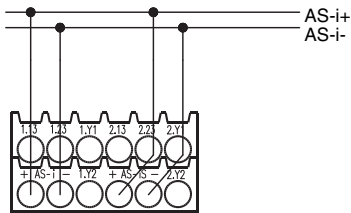

Fig. 4.0-2: Raccordement pour le contrôle d'acteur

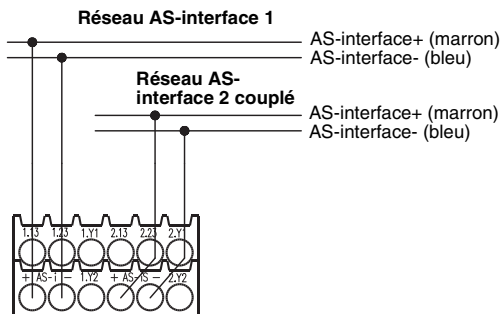

Fig. 4.0-3: Couplage pour réseaux AS-i

5 Montage

Le moniteur de sécurité AS-interface est monté par encliquetage sur un rail 35mm standard conformément à la norme EN 50022.

- Pour le retirer, appuyer fermement le moniteur contre le contre-rail supérieur et le dégager.

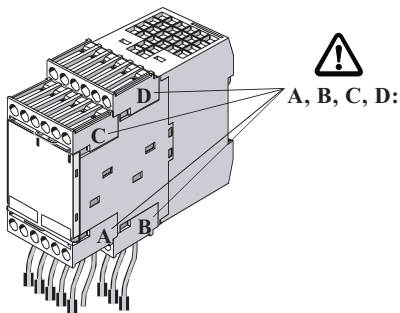

Fig. 5.0-1: Montage du moniteur de sécurité

- Pour démonter les bornes de connexion codées, faire sortir le ressort d'arrêt **a** en appuyant dessus et retirer les bornes vers l'avant.
- Lors du montage, la borne de connexion doit s'encliqueter.



1. $U = 0\text{ V}$
2. a, b, c, d

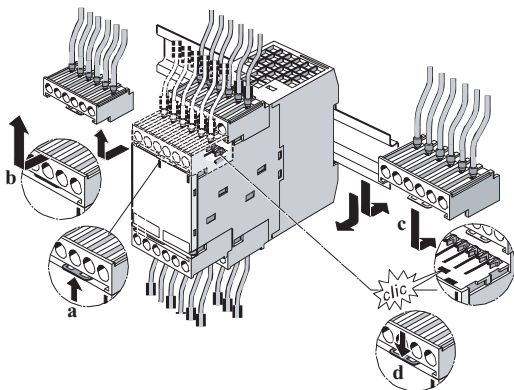
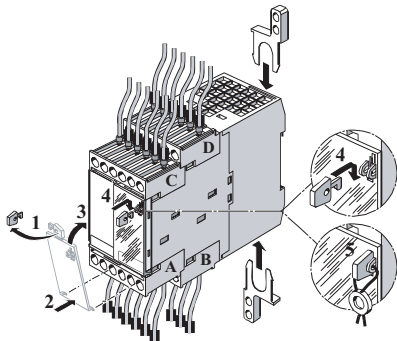

Fig. 5.0-2: Retirer et monter les bornes de connexion codées

- Placer le capuchon et le plomber selon les étapes 1-5.



a = capuchon plombé pour empêcher tout dérèglement non autorisé et pour la protection contre les ESD (contenu dans la livraison).

Fig. 5.0-3: Montage et plombage du capuchon



Vous trouverez plus de renseignements dans le manuel de raccordement et d'utilisation du moniteur de sécurité AS-interface.

6 Remplacement du moniteur de sécurité AS-interface

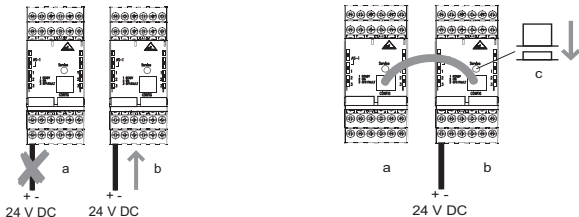

- 1 Débranchez le moniteur de sécurité AS-interface défectueux (a) de l'alimentation et raccordez le nouveau (b).
- 2 Reliez le moniteur de sécurité AS-interface défectueux (a) au nouveau moniteur de sécurité AS-interface (b) à l'aide du câble RJ45/RJ45 et appuyez sur la touche Service (c) du nouveau moniteur de sécurité (b).

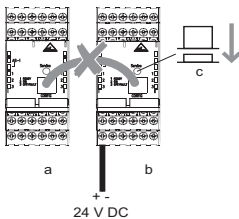

- 2 Séparez les deux moniteurs de sécurité AS-interface et appuyez à nouveau sur la touche Service.

7 Pour commander

Art. n°	Article	Description
580020	ASM1/1	Moniteur de sécurité AS-i, 1 circuit de validation
580021	ASM1/2	Moniteur de sécurité AS-i, 2 circuits de validation
580024	ASM1E/1	Moniteur de sécurité AS-i, 1 circuit de validation ; fonctionnalité étendue
580025	ASM1E/2	Moniteur de sécurité AS-i, 2 circuits de validation ; fonctionnalité étendue
580028	ASM2E/1	Moniteur de sécurité AS-i, 1 circuit de validation ; 1 sortie AS-interface sûre, fonctionnalité étendue
580029	ASM2E/2	Moniteur de sécurité AS-i, 2 circuits de validation ; 1 sortie AS-interface sûre, fonctionnalité étendue
580055	ASM1E-m/1	Moniteur de sécurité AS-i, 1 circuit de validation, fonctionnalité étendue, inhibition
580056	ASM1E-m/2	Moniteur de sécurité AS-i, 2 circuits de validation, fonctionnalité étendue, inhibition
580057	ASM2E-m/1	Moniteur de sécurité AS-i, 1 circuit de validation, 1 sortie AS-interface sûre, fonctionnalité étendue, inhibition
580058	ASM2E-m/2	AS-i Sicherheitsmonitor, 2 circuits de validation, 1 sortie AS-interface sûre, fonctionnalité étendue, inhibition

8 Pour commander les accessoires

Art. n°	Article	Description
580032	ASM-SWC	Set de mise en service ASM pour ASM1, ASM1E et ASM2E il contient : le logiciel de configuration et de diagnostic asimon, le manuel de raccordement et d'utilisation, le manuel d'utilisation du logiciel sur CD, le câble de programmation, le câble de données pour le remplacement d'appareils
50104078	ASM1-PK	Câble de paramétrage ASM1
50104079	ASM1-DK	Câble de données pour le remplacement d'appareil ASM1

Avvertenze sull'uso delle istruzioni di collegamento ed operative

Le presenti istruzioni di collegamento ed operative contengono informazioni sull'uso regolamentare ed efficiente del monitor di sicurezza AS-i.

Le avvertenze di sicurezza e di avvertimento sono indicate dal simbolo



La Leuze electronic GmbH + Co. KG non risponde dei danni causati dall'uso non regolamentare. Dell'uso regolamentare fa parte anche la conoscenza delle presenti istruzioni.

© Ristampa e riproduzione, anche per estratti, solo dietro espressa autorizzazione della:

Leuze electronic GmbH + Co. KG
Liebigstrasse 4
82256 Fuerstenfeldbruck
Telefono+49 8141 53 50-0
Fax +49 8141 53 50-190
info@leuze.de
www.leuze.com

Questa versione sommaria delle istruzioni di collegamento ed operative è fornita in dotazione.



Il monitor di sicurezza AS-i è adatto solo per essere utilizzato in sale operative/quadri elettrici con classe di protezione minima IP54.



Per il collegamento, la messa in servizio e la sostituzione del monitor di sicurezza AS-i è necessario conoscere le istruzioni di collegamento ed operative ed il manuale utente del software di configurazione e di diagnosi asimon (si vedano le avvertenze per l'ordinazione di accessori).



Avvertimento:

Tensione elettrica pericolosa!
Può provocare folgorazione ed ustioni.

Prima di iniziare i lavori staccare la tensione dall'impianto e dall'apparecchio.



A seconda dei componenti di sicurezza scelti, la classificazione dell'intero sistema di sicurezza può avvenire anche in una categoria di sicurezza inferiore.



1 Campo di impiego

Sorveglianza di slave AS-i orientati alla sicurezza ed associati mediante il software di configurazione ASiMon (ad esempio interruttori di arresto di emergenza) entro un sistema AS-i.

A seconda della variante dell'apparecchio, secondo circuito di abilitazione disponibile come uscita AS-i sicura con o senza relè.

Per sistema completamente realizzato nel modo operativo protetto spegnimento sicuro con tempo di reazione di massimo 40 ms. Possibilità di integrazione di fino a 31 slave AS-i orientati alla sicurezza.

Possibilità di servizio misto di componenti AS-i standard ed orientati alla sicurezza.

Più monitor AS-i montabili in un sistema AS-i, i quali, se necessario, sorvegliano insieme uno slave AS-i orientato alla sicurezza.

Omologazione per applicazioni di sicurezza fino alla categoria 4 secondo ISO 13849-1 PL_e.

2 Disegno quotato

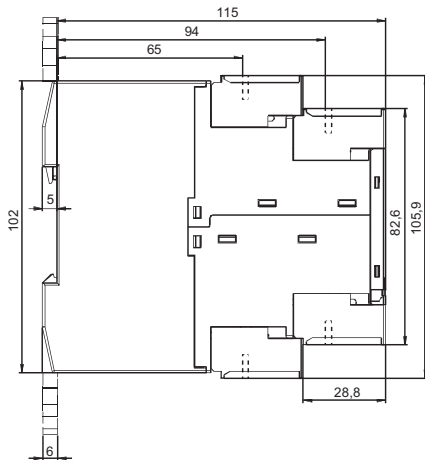
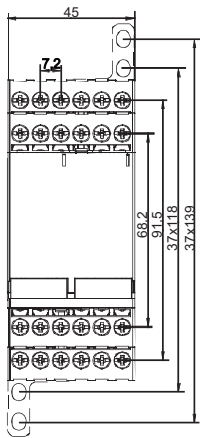

II

3 Dati tecnici

Dati elettrici

Tensione di esercizio U_b	24V CC +/- 15%	
Ondulazione residua	< 15%	
Corrente d'esercizio nominale	ASM1/1 e ASM1E/1: ASM1/2, ASM1E/2 e ASM2/1: ASM2E/2:	150mA 200mA 250mA
Corrente di picco di inserzione	tutti i tipi: 600mA	
Tempo di reazione (tecnica di sicurezza)	< 40ms	
Tempo di inizializzazione	< 10s	



Dati AS-interface

Profilo AS-i	monitor 7.F
Intervallo di tensione AS-i	18,5 ... 31,6V
Corrente assorbita AS-i	< 45mA

Dati meccanici

Dimensioni (L x A x P)	45mm x 105mm x 120mm	
Materiale carcassa	poliammide PA 66	
Peso	ASM1/1 e ASM1E/1: ASM2E/1: ASM1/2, ASM1E/2 e ASM2E/2:	circa 350g circa 420g circa 450g
Fissaggio	fissaggio a scatto su guida a cappello secondo EN 50022	

Allacciamento

	0,8 ... 1,2 Nm 7 ... 10.3 LB.IN
	1 x (0,5 ... 4,0) mm ² 2 x (0,5 ... 2,5) mm ²
	1 x (0,5 ... 2,5) mm ² 2 x (0,5 ... 1,5) mm ²
AWG	2 x 20 ... 14

Interfaccia di configurazione

RS 232

9600 Baud, no parity, 1 bit di start, 1 bit di stop,
8 bit utili

Ingressi e uscite

Ingresso «Start»

ingresso accoppiatore ottico (attivo High),
corrente di entrata ca. 10mA a 24V CC

Ingresso «circuitto di retroazione» (EDM)

ingresso accoppiatore ottico (attivo High),
corrente di entrata ca. 10mA a 24V CC

Uscita messaggi «Safety on»

uscita transistor PNP, 200mA,
protezione contro cortocircuiti e inversione di polarità

Uscita di sicurezza

contatti di chiusura a potenziale zero,
max. carico sui contatti: 1A CC-13 a 24V CC
3A CA-15 a 230V CA

Corrente termica permanente massima

ASM1/1, ASM1E/1 e ASM2E/1:

corrente totale massima per tutti gli elementi di commut. di uscita: 6A

cioè circuito di uscita 1: 3A per elemento di commut. di uscita

ASM1/2, ASM1E/2 e ASM2E/2:

corrente totale massima per tutti gli elementi di commut. di uscita: 8A

cioè circuito di uscita 1: 3A per elemento di commut. di uscita

circuito di uscita 2: 1A per elemento di commut. di uscita

oppure circuito di uscita 1: 2A per elemento di commut. di uscita

circuito di uscita 2: 2A per elemento di commut. di uscita

Fusibile

esterno con max. 4A MT

Categoria sovratensione

3, per tensione di esercizio nominale 300V CA secondo VDE 0110 Parte 1

Dati ambientali

Temperatura di esercizio

-20 ... +60°C

Temperatura di magazzinaggio

-30 ... +70°C

Tipo di protezione

IP 20



Attenzione!

Utilizzare sempre il fusibile prescritto; solo così è garantito lo spegnimento sicuro in caso di guasto.



Attenzione!

- Al tempo di reazione del sistema pari a max. 40ms occorre aggiungere i tempi di reazione dello slave sensore AS-interface sicuro, del sensore utilizzato per la sorveglianza, dello slave attuatore AS-interface sicuro e dell'attuatore utilizzato a tale scopo.
Si tenga presente che anche dalla parametrizzazione del monitor di sicurezza possono derivare ulteriori tempi di reazione.
- Si aggiungono i tempi di reazione di sistema dei componenti AS-interface concatenati nell'accoppiamento di reti AS-interface.

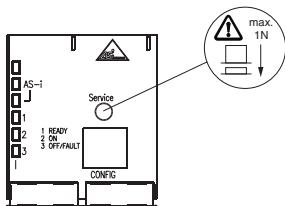

4 Installazione elettrica



Attenzione!

L'installazione elettrica deve essere eseguita solo da personale qualificato ed addestrato.



Attenzione!

Ogni slave AS-interface orientato alla sicurezza deve essere attivato almeno una volta all'anno ed il suo comportamento di commutazione deve essere controllato osservando i circuiti di uscita del monitor di sicurezza AS-interface.

Dopo la sostituzione di uno slave AS-i orientato alla sicurezza è necessario controllare il corretto funzionamento del nuovo slave e, se si sostituisce un monitor di sicurezza AS-i, il corretto funzionamento del nuovo monitor di sicurezza AS-i.

Posare le linee di alimentazione e di segnale ed anche la linea del bus AS-i separatamente dalle linee in cui circolano alte intensità di corrente.

Per i contattori nel quadro elettrico utilizzare un dispositivo adatto di soppressione degli archi.

Per motori e freni si tengano presenti le avvertenze di installazione delle relative istruzioni per l'uso.

Lunghezza massima della linea del bus AS-i: 100 m. Per linee di lunghezza maggiore utilizzare ripetitori AS-i.



Attenzione!

L'alimentatore di rete AS-interface per l'alimentazione dei componenti AS-interface deve presentare una separazione sicura dalla rete, secondo IEC 60742 e deve superare brevi interruzioni dell'alimentazione fino a 20ms. Anche l'alimentatore di rete per l'alimentazione a 24 V deve presentare una separazione sicura dalla rete secondo IEC 60742 e superare brevi interruzioni dell'alimentazione fino a 20ms.

Indicatori a LED ASM

LED	Colore	Significato
AS-i 1	spento	alimentazione interrotta
	verde, continuo	alimentazione AS-interface presente
AS-i 2	spento	servizio normale
	rosso, continuo	errore di comunicazione
AS-iS 1	spento	alimentazione interrotta
	verde, continuo	alimentazione AS-interface presente
AS-iS 2	spento	servizio normale
	rosso, continuo	errore di comunicazione
1 READY (per ogni circuito di uscita)	spento	–
	giallo, continuo	blocco avviamento/riavviamento attivo
	giallo, intermittente	è necessario un test esterno / conferma / ritardo di accensione attivo
2 ON (per ogni circuito di uscita)	spento	contatti dell'elemento di commutazione di uscita aperti
	verde, continuo	contatti dell'elemento di commutazione di uscita chiusi
	verde, intermittente	il tempo di ritardo scorre con categoria di arresto 1
3 OFF/ FAULT (per ogni circuito di uscita)	spento	contatti dell'elemento di commutazione di uscita chiusi
	rosso, continuo	contatti dell'elemento di commutazione di uscita aperti
	rosso, intermittente	errore al livello dei componenti AS-interface monitorati
1 READY 2 ON 3 OFF/ FAULT (per ogni circuito di uscita)	intermittente rapido contemporaneo	errore interno dell'apparecchio, segnalazione errore interrogabile tramite il software asimon

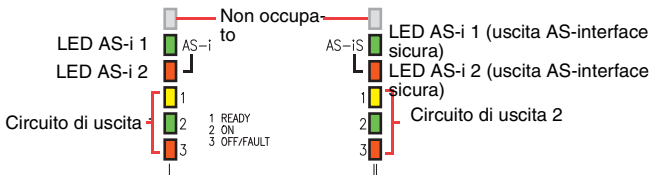

Fig. 4.0-1: Indicatori a LED nell'apparecchio

Occupazione dei morsetti dei monitor di sicurezza AS-i ASM1/1 e ASM1E/1

Morsetto	Segnale / Descrizione	Collegamento elettrico
AS-i+	Collegamento al bus AS-interfaccia	
AS-i-		
L+	+24V CC / tensione di alimentazione	
M	GND / collegamento per messa a terra di riferimento	
FE	Collegamento per messa a terra funzionale	
1.Y1	EDM 1 / ingresso circuito di retroazione	
1.Y2	Start 1 / ingresso di start	
1.13 ¹⁾ 1.14	Elemento di commutazione di uscita 1	
1.23 ¹⁾ 1.24	Elemento di commutazione di uscita 2	
1.32	Uscita messaggi «Safety on»	

1) Fusibili come da dati tecnici

Occupazione dei morsetti dei monitor di sicurezza AS-i ASM1/2 e ASM1E/2

Morsetto	Segnale / Descrizione	Collegamento elettrico
AS-i+	Collegamento al bus AS-interface	
AS-i-		
L+	+24V CC / tensione di alimentazione	
M	GND / collegamento per messa a terra di riferimento	
FE	Collegamento per messa a terra funzionale	
1.Y1	EDM 1 / ingresso circuito di retroazione, circuito di uscita 1	
1.Y2	Start 1 / ingresso di start, circuito di uscita 1	
1.13 ¹⁾	Elemento di commutazione di uscita 1, circuito di uscita 1	
1.14		
1.23 ¹⁾	Elemento di commutazione di uscita 2, circuito di uscita 1	
1.24		
1.32	Uscita messaggi 1 «Safety on», circuito di uscita 1	
2.Y1	EDM 2 / ingresso circuito di retroazione, circuito di uscita 2	
2.Y2	Start 2 / ingresso di start, circuito di uscita 2	
2.13 ¹⁾	Elemento di commutazione di uscita 1, circuito di uscita 2	
2.14		
2.23 ¹⁾	Elemento di commutazione di uscita 2, circuito di uscita 2	
2.24		
2.32	Uscita messaggi 2 «Safety on», circuito di uscita 2	

1) Fusibili come da dati tecnici

Occupazione dei morsetti dei monitor di sicurezza AS-i ASM2E/1 e ASM2E/2

Morsetto	Segnale / Descrizione	Collegamento elettrico
AS-i+	Collegamento al bus AS-interface	
AS-i-		
AS-iS+	Uscita AS-interface sicura per la sorveglianza dell'attuatore o accoppiamento di un'altra rete AS-interface	
AS-iS-		
L+	+24V CC / tensione di alimentazione	
M	GND / collegamento per messa a terra di riferimento	
FE	Collegamento per messa a terra funzionale	
1.Y1	EDM 1 / ingresso circuito di retroazione, circuito di uscita 1	
1.Y2	Start 1 / ingresso di start, circuito di uscita 1	
1.13 1)	Elemento di commutazione di uscita 1, circuito di uscita 1	
1.14		
1.23 1)	Elemento di commutazione di uscita 2, circuito di uscita 1	
1.24		
1.32	Uscita messaggi 1 «Safety on», circuito di uscita 1	
2.Y1	EDM 2 / ingresso circuito di retroazione, circuito di uscita 2	
2.Y2	Start 2 / ingresso di start, circuito di uscita 2	
2.13 1)	Elemento di commutazione di uscita 1, circuito di uscita 2 (solo ASM2E/2)	
2.14		

SOLO ASM2E/2:

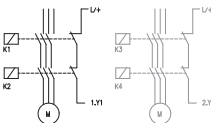

Morsetto	Segnale / Descrizione	Collegamento elettrico
2.23 ¹⁾	Elemento di commutazione di uscita 2, circuito di uscita 2 (solo ASM2E/2!)	
2.24		
2.32	Uscita messaggi 2 «Safety on», circuito di uscita 2	

1) Fusibili come da dati tecnici

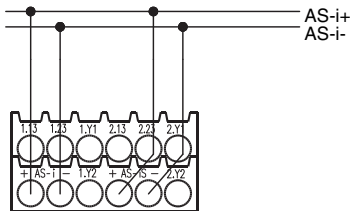

Fig. 4.0-2: Collegamento per sorveglianza attuatore

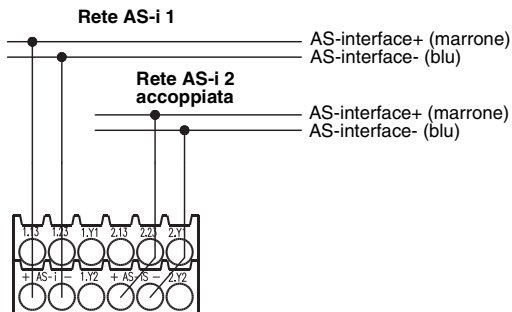

Fig. 4.0-3: Accoppiamento per reti AS-i

5 Montaggio

Il montaggio del monitor di sicurezza avviene applicandolo su una guida a norma da 35 mm secondo EN 50022.

- Per rimuoverlo, premere con forza il monitor contro la guida superiore e toglierlo facendo leva.



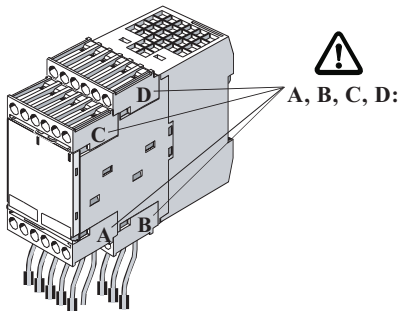

Fig. 5.0-1: Montaggio del monitor di sicurezza

- Per togliere i morsetti codificati, spingere e rimuovere la molla di sicurezza **a** ed estrarre il morsetto dal lato anteriore.
- Per il rimontaggio, il morsetto deve innestarsi con uno scatto udibile.



1. $U = 0\text{ V}$
2. a, b, c, d

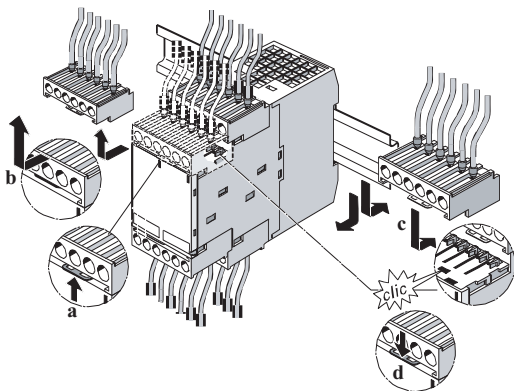
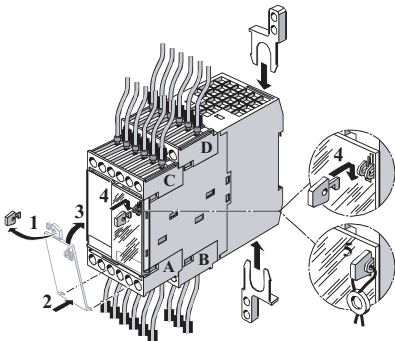

Fig. 5.0-2: Smontaggio e montaggio dei morsetti codificati

- Applicare il cappuccio e piombare nei passi 1-5.



a = cappuccio piombabile per la protezione contro la manipolazione e ESD (in dotazione).

Fig. 5.0-3: Montaggio e piombatura del cappuccio



Per ulteriori avvertenze si vedano le istruzioni di collegamento ed operative del monitor di sicurezza AS-i.

6 Sostituzione del monitor di sicurezza AS-i

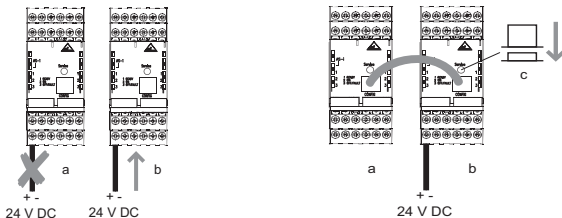

- 1 Staccare il monitor di sicurezza AS-i 2 guasto (a) dall'alimentazione e collegare quello nuovo (b). Collegare il monitor di sicurezza AS-i 2 guasto (a) ed il nuovo monitor di sicurezza AS-i (b) mediante il cavo RJ45/RJ45 e premere il tasto Service (c) del nuovo monitor di sicurezza AS-i.

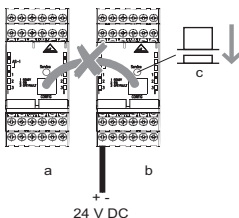

- 2 Staccare i due monitor di sicurezza AS-i e ripremere il tasto Service.

7 Per ordinare articoli

Cod. art.	Articolo	Descrizione
580020	ASM1/1	Monitor di sicurezza AS-i, 1 circuito di abilitazione
580021	ASM1/2	Monitor di sicurezza AS-i, 2 circuiti di abilitazione
580024	ASM1E/1	Monitor di sicurezza AS-i, 1 circuito di abilitazione; funzionalità ampliata
580025	ASM1E/2	Monitor di sicurezza AS-i, 2 circuiti di abilitazione; funzionalità ampliata
580028	ASM2E/1	Monitor di sicurezza AS-i, 1 circuito di abilitazione, 1 uscita AS-i sicura, funzionalità ampliata
580029	ASM2E/2	Monitor di sicurezza AS-i, 2 circuiti di abilitazione, 1 uscita AS-i sicura, funzionalità ampliata
580055	ASM1E-m/1	Monitor di sicurezza AS-i, 1 circuito di abilitazione, funzionalità ampliata, Muting
580056	ASM1E-m/2	Monitor di sicurezza AS-i, 2 circuiti di abilitazione, erw. Funktionalität, Muting
580057	ASM2E-m/1	Monitor di sicurezza AS-i, 1 circuito di abilitazione, 1 uscita AS-i sicura, funzionalità ampliata, Muting
580058	ASM2E-m/2	Monitor di sicurezza AS-i, 2 circuiti di abilitazione, 1 uscita AS-i sicura, funzionalità ampliata, Muting

8 Ordinazione di accessori

Cod. art.	Articolo	Descrizione
580032	ASM-SWC	Kit di messa in servizio ASM per ASM1, ASM1E e ASM2E Contenuto: software di configurazione e di diagnosi asimon, istruzioni di collegamento ed operative, manuale utente software su CD, cavo di programmazione, cavo dati per la sostituzione dell'apparecchio
50104078	ASM1-PK	Cavo di parametrizzazione ASM1
50104079	ASM1-DK	Cavo dati per la sostituzione dell'apparecchio ASM1

Indicaciones para el uso de las instrucciones para la conexión y la operación

Estas instrucciones para la conexión y la operación contienen información sobre el uso eficaz y conforme a lo prescrito del monitor de seguridad AS-i.

Las indicaciones de seguridad y de advertencia están señaladas con el símbolo



Leuze electronic GmbH + Co. KG no se responsabiliza de aquellos daños que se deriven de un uso indebido. El conocimiento de estas instrucciones forma parte de la utilización apropiada.

© Reimpresión y reproducción, aún parcial, sólo con la autorización expresa de:

Leuze electronic GmbH + Co. KG
Liebigstrasse 4
82256 Fuerstenfeldbruck / Alemania
Teléfono +49 8141 53 50-0
Fax +49 8141 53 50-190
info@leuze.de
www.leuze.com

Este resumen de las instrucciones para la conexión y la operación es parte integrante del suministro.



El monitor de seguridad AS-i es apropiado únicamente para ser utilizado en recintos de operación eléctricos/armarios eléctricos que tengan como mínimo el grado de protección IP54.



Para conectar, poner en marcha y sustituir el monitor de seguridad AS-i se tienen que conocer las instrucciones para la conexión y la operación, así como el manual de usuario del software de configuración y diagnóstico de asimon (vea las instrucciones para cursar pedidos de accesorios)



Advertencia:

¡Tensión eléctrica peligrosa!

Puede originar descargas eléctricas y quemaduras.

Antes de comenzar los trabajos, desconectar la tensión eléctrica de la instalación y del equipo.



¡Dependiendo de los componentes de seguridad que se utilicen, el sistema de seguridad en su conjunto puede quedar clasificado dentro de una categoría de seguridad inferior!



1 Campo de aplicación

Supervisión de esclavos de seguridad AS-i (p. ej. interruptores de parada de emergencia) asignados con el software de configuración ASiMon dentro de un sistema AS-i.

Según la variante del equipo el segundo circuito de habilitación está disponible como salida AS-i segura con o sin relé.

Con la configuración máxima del sistema, desactivación segura en el modo de operación de protección con un tiempo de respuesta de máx. 40 ms. Integración posible de hasta 31 esclavos de seguridad AS-i.

Funcionamiento mixto factible de componentes AS/i estándar y de seguridad.

Pueden emplearse varios monitores de seguridad AS-i dentro de un sistema AS-i, que en caso necesario supervisarán conjuntamente un esclavo de seguridad AS-i.

Homologado para aplicaciones de seguridad hasta la categoría 4 según ISO 13849-1 PLe.

2 Dibujo acotado

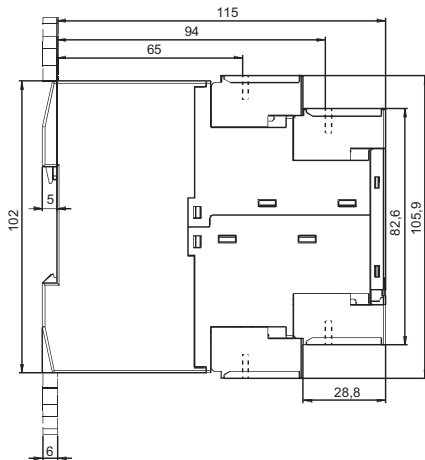
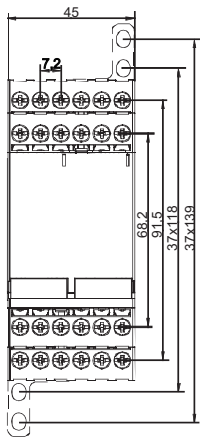

ES

3 Datos técnicos

Datos eléctricos

Tensión de servicio U_s	24 V CC +/- 15 %
Rizado residual	< 15 %
Corriente de servicio asignado	ASM1/1 y ASM1E/1: 150mA ASM1/2, ASM1E/2 y ASM2/1: 200mA ASM2E/2: 250mA
Corriente de cresta al conectar	todos los tipos: 600mA
Tiempo de reacción (seguridad técnica)	< 40 ms
Tiempo de inicialización	< 10 s



Datos AS-interface

Perfil AS-i	monitor 7.F
Rango de tensión AS-i	18,5 ... 31,6 V
Consumo de corriente AS-i	< 45 mA

Datos mecánicos

Dimensiones (ancho x alto x profundo)	45 mm x 105 mm x 120 mm
Material de la carcasa	poliamida PA 66
Peso	ASM1/1 y ASM1E/1: aprox. 350g ASM2E/1: aprox. 420g ASM1/2, ASM1E/2 y ASM2E/2: aprox. 450g
Fijación	dispositivo de fijación instantánea en perfil soporte normalizado según EN 50022

Conexión

 Ø 5 ... 6 mm / PZ2	0,8 ... 1,2 Nm 7 ... 10.3 LB.IN
	1 x (0,5 ... 4,0) mm ² 2 x (0,5 ... 2,5) mm ²
	1 x (0,5 ... 2,5) mm ² 2 x (0,5 ... 1,5) mm ²
AWG	2 x 20 ... 14

Interface de configuración

RS 232

9600 baudios, sin paridad, 1 bit de arranque, 1 bit de stop, 8 bits de datos

Entradas y salidas

Entrada «Arranque»

Entrada de optoacoplador (high activo), corriente de entrada aprox. 10 mA a 24 V CC

Entrada "circuito de retorno" (EDM)

Entrada de optoacoplador (high activo), corriente de entrada aprox. 10 mA a 24 V CC

Salida de señalización «Safety on»

Salida de transistor PNP, 200 mA, protección contra cortocircuitos e inversión de polaridad

Salida de seguridad

Contactos NA flotantes, máx. carga de contacto:
1 A CC-13 a 24 V CC
3 A CA-15 a 230 V CA

Corriente térmica permanente máxima

ASM1/1, ASM1E/1 y ASM2E/1:

máxima intensidad total de todos los elementos de conmutación de salida: 6A

es decir, circ. de salida 1: 3A por elemento de conm. de salida

ASM1/2, ASM1E/2 y ASM2E/2:

máx. intensidad total de todos los elementos de conmutación de salida: 8A

es decir, circ. de salida 1: 3A por elemento de conm. de salida

circuito de salida 2: 1A por elemento de conm. de salida

o circuito de salida 1: 2A por elemento de conm. de salida

circuito de salida 2: 2A por elemento de conm. de salida

Fusible

externo con máx. 4 A MT

Categoría de sobretensión

3, para tensión de empleo asignada 300 V CA según VDE 0110 parte 1

Datos ambientales

Temperatura de operación -20 ... +60°C

Temperatura de almacenamiento -30 ... +70°C

Tipo de protección IP 20



¡Cuidado!

Es imperativo que respete la protección por fusible prescrita; únicamente de este modo está garantizada la desactivación en caso de fallo.



¡Cuidado!

- Además del tiempo de reacción del sistema de máx. 40ms se deben sumar los tiempos de reacción del esclavo AS-interface de seguridad del sensor, del sensor utilizado para la supervisión, del esclavo AS-interface de seguridad del actor, y del actuador utilizado para ello.

Tenga presente que con la parametrización del monitor de seguridad también pueden producirse tiempos de reacción adicionales.

- Se suman los tiempos de reacción del sistema de los componentes AS-Interface encadenados cuando hay redes AS-Interface acopladas.

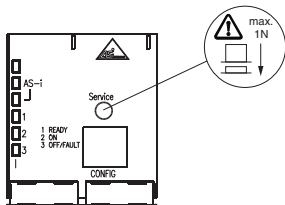

4 Instalación eléctrica



¡Cuidado!

La instalación eléctrica debe realizarla únicamente personal especializado e instruido.



¡Cuidado!

Cada uno de los esclavos de seguridad AS-Interface debe ser accionado como mínimo una vez al año, y su comportamiento de conmutación debe ser controlado observando los circuitos de salida del monitor de seguridad AS-Interface.

Cuando se sustituya un esclavo de seguridad AS-i se debe comprobar el correcto funcionamiento del nuevo esclavo, y cuando se sustituya un monitor de seguridad AS-i el correcto funcionamiento del nuevo monitor de seguridad AS-i.

Tender las líneas de alimentación, las de señales y la línea de bus AS-i separadas de las líneas de fuerza.

En el armario eléctrico, utilizar para los contactores un extintor de chispas apropiado.

Con motores y frenos de accionamiento, atender a las instrucciones de instalación de los manuales respectivos.

Máx. longitud de cable de bus AS-i 100 m. Utilizar repetidores AS-i para cables de longitudes mayores.



¡Cuidado!

La fuente de alimentación AS-interface para los componentes AS-interface debe tener un dispositivo de corte de la red según IEC 60742 y soportar cortes breves de la red de hasta 20ms. La fuente para la alimentación de 24 V también debe tener un dispositivo de corte de la red según IEC 60742 y soportar cortes breves de la red de hasta 20 ms.

LED indicadores ASM

LED	Color	Significado
AS-i 1	Apagado	No hay alimentación
	Verde, luz permanente	Hay alimentación AS-interface
AS-i 2	Apagado	Operación normal
	Rojo, luz permanente	Error de comunicación
AS-iS 1	Apagado	No hay alimentación
	Verde, luz permanente	Hay alimentación AS-interface
AS-iS 2	Apagado	Operación normal
	Rojo, luz permanente	Error de comunicación
1 READY (por circuito de salida)	Apagado	–
	Amarillo, luz permanente	Bloqueo de arranque/rearranque activo
	Amarillo, parpadeante	Test externo necesario/acuse de recibo/retardo a la conexión activo
2 ON (por circuito de salida)	Apagado	Contactos del elemento de conmutación de salida abiertos
	Verde, luz permanente	Contactos del elemento de conmutación de salida cerrados
	Verde, parpadeante	Tiempo de retardo corre con categoría de stop 1
3 OFF/ FAULT (por circuito de salida)	Apagado	Contactos del elemento de conmutación de salida cerrados
	Rojo, luz permanente	Contactos del elemento de conmutación de salida abiertos
	Rojo, parpadeante	Error a nivel de los componentes AS-interface vigilados
1 READY 2 ON 3 OFF/ FAULT (por circuito de salida)	Parpadeo simultáneo rápido	Fallo interno del equipo, el mensaje de error puede consultarse vía software asimon

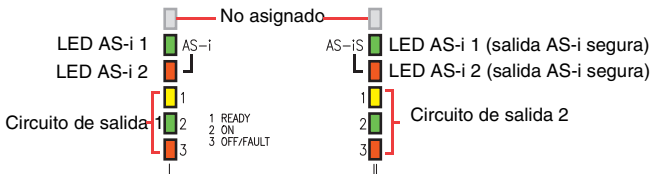

Fig. 4.0-1: LEDs indicadores en el equipo

Ocupación de bornes para el monitor de seguridad AS-i, ASM1/1 y ASM1E/1

Borne	Señal / Descripción	Conexión eléctrica
AS-i+	Conexión al bus AS-interface	
AS-i-		
L+	+24 V CC / tensión de alimentación	
M	GND / tierra de referencia	
FE	Tierra funcional	
1.Y1	EDM 1 / entrada circuito de retorno	
1.Y2	Arranque 1 / entrada de arranque	
1.13 ¹⁾	Elemento de conmutación de salida 1	
1.14		
1.23 ¹⁾	Elemento de conmutación de salida 2	
1.24		
1.32	Salida de señalización «Safety on»	

1) Protección conforme a los datos técnicos

Ocupación de bornes para el monitor de seguridad AS-i, ASM1/2 y ASM1E/2

Borne	Señal / Descripción	Conexión eléctrica
AS-i+	Conexión al bus AS-interface	
AS-i-		
L+	+24 V CC / tensión de alimentación	
M	GND / tierra de referencia	
FE	Tierra funcional	
1.Y1	EDM 1 / entrada circuito de retorno, circuito de salida 1	
1.Y2	Arranque 1 / entrada de arranque, circuito de salida 1	
1.13 ¹⁾	Elemento de conmutación de salida 1, circuito de salida 1	
1.14		
1.23 ¹⁾	Elemento de conmutación de salida 2, circuito de salida 1	
1.24		
1.32	Salida de señalización 1 «Safety on», circuito de salida 1	
2.Y1	EDM 2 / entrada circuito de retorno, circuito de salida 2	
2.Y2	Arranque 2 / entrada de arranque, circuito de salida 2	
2.13 ¹⁾	Elemento de conmutación de salida 1, circuito de salida 2	
2.14		
2.23 ¹⁾	Elemento de conmutación de salida 2, circuito de salida 2	
2.24		
2.32	Salida de señalización 2 «Safety on», circuito de salida 2	

1) Protección conforme a los datos técnicos

Ocupación de bornes para monitores de seguridad AS-i ASM2E/1 y ASM2E/2

Borne	Señal / Descripción	Conexión eléctrica
AS-i+	Conexión al bus AS-interface	
AS-i-		
AS-iS+	Salida AS-interface de seguridad para supervisión de actuador o acoplamiento de otra red AS-interface	
AS-iS-		
L+	+24 V CC / tensión de alimentación	
M	GND / tierra de referencia	
FE	Tierra funcional	
1.Y1	EDM 1 / entrada circuito de retorno, circuito de salida 1	
1.Y2	Arranque 1 / entrada de arranque, circuito de salida 1	
1.13 ¹⁾	Elemento de conmutación de salida 1, circuito de salida 1	
1.14		
1.23 ¹⁾	Elemento de conmutación de salida 2, circuito de salida 1	
1.24		
1.32	Salida de señalización 1 «Safety on», circuito de salida 1	
2.Y1	EDM 2 / entrada circuito de retorno, circuito de salida 2	
2.Y2	Arranque 2 / entrada de arranque, circuito de salida 2	
2.13 ¹⁾	Elemento de conmutación de salida 1, circuito de salida 2 (¡sólo ASM2E/2!)	
2.14		
2.23 ¹⁾	Elemento de conmutación de salida 2, circuito de salida 2 (¡sólo ASM2E/2!)	
2.24		
2.32	Salida de señalización 2 «Safety on», circuito de salida 2	

SÓLO ASM2E/2:

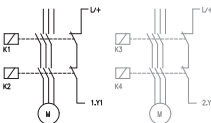

ES

1) Protección conforme a los datos técnicos

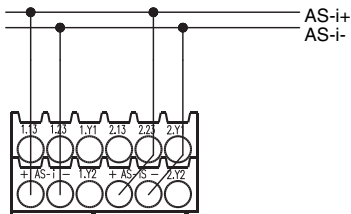

Fig. 4.0-2: Conexión para supervisión de actuador

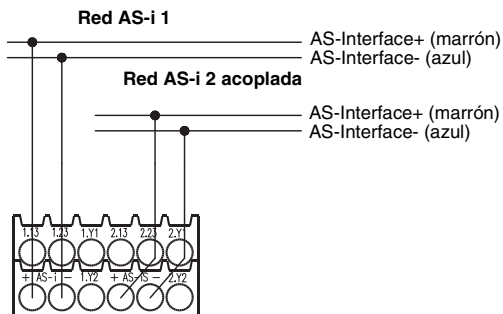

Fig. 4.0-3: Acoplamiento en redes AS-i

5 Montaje

El monitor de seguridad se monta fijándolo con clips en un perfil normalizado de 35 mm según EN 50022.

- Para retirar el monitor, presionar con vigor hacia la guía superior del perfil y extraerlo hacia arriba.

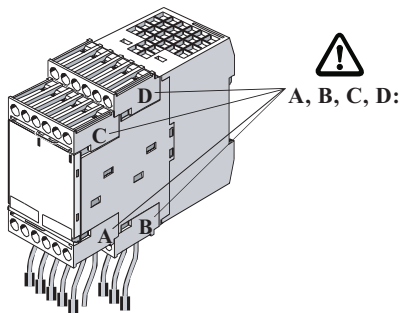

Fig. 5.0-1: Montaje del monitor de seguridad

- Para sacar los bornes de conexión codificados, empujar hacia afuera las celdas de los fusibles **a** y retirar el borne hacia adelante.
- Al encajarlo el borne de conexión tiene que enclavarse haciendo un clic.



1. $U = 0 \text{ V}$
2. a, b, c, d

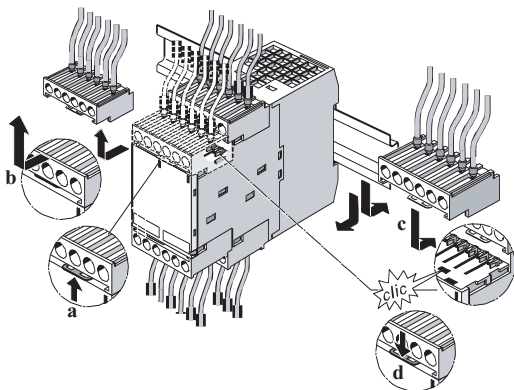
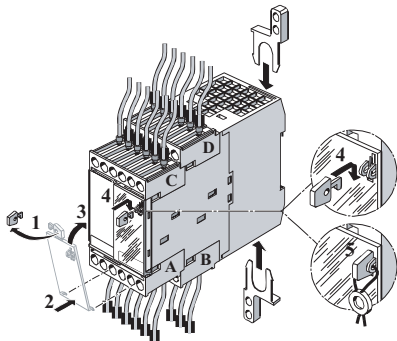

Fig. 5.0-2: Desmontar y encajar los bornes de conexión codificados

- Colocar la tapa de protección y precintarla en pasos 1-5.



a = Tapa de protección precintable para asegurar el equipo contra variaciones no autorizadas y como protección antiestática (parte del alcance del suministro).

Fig. 5.0-3: Montaje y precintado de la tapa de protección



Vea más indicaciones en las instrucciones para la conexión y la operación del monitor de seguridad AS-i.

6 Sustitución del monitor de seguridad AS-i

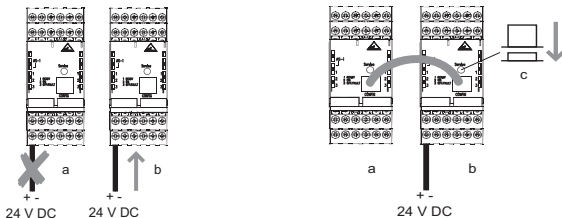

- 1 Separe el monitor de seguridad AS-i 2 averiado (a) de la alimentación y conecte el nuevo (b). Conecte el monitor de seguridad AS-i averiado (a) y el nuevo (b) mediante el cable RJ45/RJ45 y pulse la tecla de servicio (c) del monitor de seguridad AS-i nuevo (b).

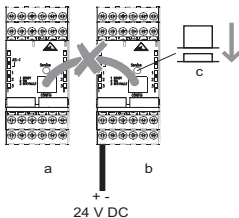

- 2 Separe los dos monitores de seguridad AS-i y pulse de nuevo la tecla de servicio.

7 Indicaciones de pedido

Núm. art.	Artículo	Descripción
580020	ASM1/1	Monitor de seguridad AS-i, 1 circuito de habilitación
580021	ASM1/2	Monitor de seguridad AS-i, 2 circuitos de habilitación
580024	ASM1E/1	Monitor de seguridad AS-i, 1 circuito de habilitación; funcionalidad ampliada
580025	ASM1E/2	Monitor de seguridad AS-i, 2 circuitos de habilitación; funcionalidad ampliada
580028	ASM2E/1	Monitor de seguridad AS-i, 1 circuito de habilitación, 1 salida AS-i segura, funcionalidad ampliada
580029	ASM2E/2	Monitor de seguridad AS-i, 2 circuitos de habilitación, 1 salida AS-i segura, funcionalidad ampliada
580055	ASM1E-m/1	Monitor de seguridad AS-i, 1 circuito de habilitación, funcionalidad ampliada, inhibición
580056	ASM1E-m/2	Monitor de seguridad AS-i, 2 circuitos de habilitación, funcionalidad ampliada, inhibición
580057	ASM2E-m/1	Monitor de seguridad AS-i, 1 circuito de habilitación, 1 salida AS-i segura, funcionalidad ampliada, inhibición
580058	ASM2E-m/2	Monitor de seguridad AS-i, 2 circuitos de habilitación, 1 salida AS-i segura, funcionalidad ampliada, inhibición

8 Instrucciones para cursar pedidos de accesorios

Núm. art.	Artículo	Descripción
580032	ASM-SWC	Kit de puesta en marcha ASM para ASM1, ASM1E y ASM2E contiene: software de configuración y de diagnóstico asimon, instrucciones para la conexión y la operación, manual de usuario software en CD, cable de programación, cable de datos para sustituir equipos
50104078	ASM1-PK	Cable de parametrización ASM1
50104079	ASM1-DK	Cable de datos para sustituir equipos ASM1

Informatie voor het gebruik van de aansluit- en gebruikshandleiding

Deze aansluit- en gebruikshandleiding bevat informatie over deskundig en effectief gebruik van de AS-i bewakingsmonitor.

Veiligheidsinformatie en waarschuwingen worden aangeduid met het symbool



Leuze electronic GmbH + Co. KG is niet aansprakelijk voor schade die veroorzaakt wordt door onjuist gebruik. Voor deskundig gebruik dient u ook de inhoud van deze handleiding te kennen.

© Kopiëren en verveelvoudiging, ook uittreksels, alleen met uitdrukkelijke toestemming door:

Leuze electronic GmbH + Co. KG
Liebigstrasse 4
D-82256 Fuerstenfeldbruck
Tel. +49 8141 53 50-0
Fax +49 8141 53 50-190
info@leuze.de
www.leuze.com

Deze samenvatting van de aansluit- en gebruikshandleiding is onderdeel van de levering.



De AS-i bewakingsmonitor is alleen geschikt voor het gebruik in elektrische bedrijfsruimtes/schakelkasten met minimaal veiligheidstype IP54.



Voor het aansluiten, in gebruik nemen en ruilen van de AS-i bewakingsmonitor behoort de kennis van de inhoud van de aansluit- en gebruikshandleiding alsmede van het gebruikershandboek van de asimon-configuratie- en diagnosesoftware (zie bestelinformatie Accessoires)



Waarschuwing:

Gevaarlijke elektrische spanning!

Kan leiden tot elektrische schokken en verbrandingen.

Voor het begin van de werkzaamheden de installatie en het apparaat spanningsvrij schakelen.



Al naargelang de keuze van de gebruikte veiligheidsonderdelen kan de indeling van het totale veiligheidssysteem ook in een lagere veiligheids categorie plaatsvinden!



1 Toepassingsgebied

Controle van de veilige AS-i slave (bijv. noodstop) in een AS-i-systeem en die via de configuratiesoftware ASiMon is toegewezen .

Afhankelijk van het type apparaat van het tweede vrijgavecircuit als beveiligde AS-i uitgang met of zonder relais beschikbaar.

Bij een volledige systeemuitbouw in protected mode heeft een veilige uitschakeling een aanspreektijd van maximaal 40 ms. Daarbij zijn maximaal 31 beveiligde AS-i slaves mogelijk.

Gemengd gebruik van standaard- en beveiligde AS-i componenten mogelijk.

Er zijn meerdere AS-i-bewakingsmonitoren in een AS-i systeem inzetbaar, die indien nodig gezamenlijk een beveiligde AS-i slave bewaken.

Voor veiligheidsdoeleinden tot categorie 4 volgens ISO 13849-1 PLe toegestaan.

2 Afmetingen

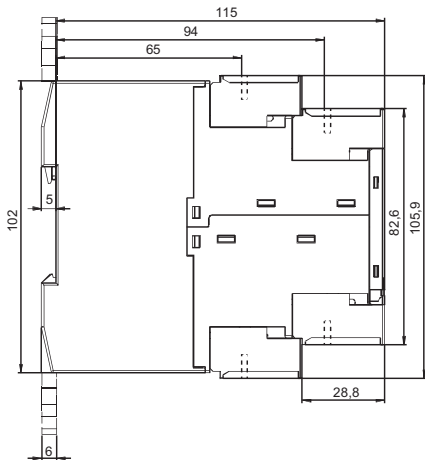
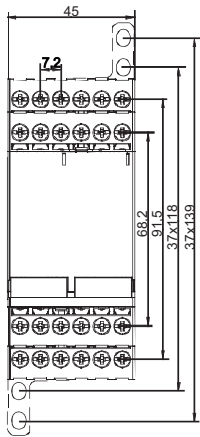

3 Technische data

Elektrische data

Bedrijfsspanning U_b	24V DC +/- 15%
Restrimpel	< 15%
Instelling bedrijfsstroom	ASM1/1 en ASM1E/1: 150mA ASM1/2, ASM1E/2 en ASM2/1: 200mA ASM2E/2: 250mA
Inschakelpiekstroom	alle typen: 600mA
Reactietijd (veiligheidstechnisch)	< 40ms
Back-upvertraging	< 10s



AS-Interfacedata

AS-i-Profiel	Monitor 7.F
AS-i-Spanningsbereik	18,5 ... 31,6V
AS-i-Stroomopname	< 45mA

Mechanische data

Afmetingen (B x H x D)	45 mm x 105mm x 120mm
Behuizingsmateriaal	Polyamide PA 66
Gewicht	ASM1/1 en ASM1E/1: ca. 350g ASM2E/1: ca. 420g ASM1/2, ASM1E/2 en ASM2E/2: ca. 450g
Bevestiging	Klikbevestiging op kapgeleider overeenkomstig EN 50022

Aansluiting

 Ø 5 ... 6 mm / PZZ	0,8 ... 1,2 Nm 7 ... 10.3 LB.IN
	1 x (0,5 ... 4,0) mm ² 2 x (0,5 ... 2,5) mm ²
	1 x (0,5 ... 2,5) mm ² 2 x (0,5 ... 1,5) mm ²
AWG	2 x 20 ... 14

Configuratie-interface

RS 232	9600 Baud, tegen Parity, 1 Startbit, 1 Stopbit, 8 Databits
In- en output	
Input "Start"	Opto-koppeling input (High-active), ingangsstroom ca. 10 mA bij 24V DC
Input "Retourkring" (EDM)	Opto-koppeling input (High-active), ingangsstroom ca. 10 mA bij 24V DC
Melding output "Safety on"	PNP-Transistor output, 200 mA, kortsluit- en verpolbeveiliging
Safety output	Potentiaalvrije sluitcontacten, max. contactbelasting: 1 A DC-13 bij 24V DC 3 A AC-15 bij 230V AC
Thermische continuustroom maximal	<u>ASM1/1, ASM1E/1 en ASM2E/1:</u> maximale somstroom voor alle output schakelementen: 6 A dat betekent output schakelementen circuit 1: 3 A elke output schakelement <u>ASM1/2, ASM1E/2 en ASM2E/2:</u> max. somstroom voor alle output schakelementen: 8 A dat betekent output circuit 1: 3 A elke output schakelement output circuit 2: 1 A elke output schakelement of output circuit 1: 2 A elke output schakelement output circuit 2: 2 A elke output schakelement
Afzekering	extern met max. 4 A MT
Overspanningscategorie	3, voor instelling bedrijfsspanning 300V AC volgens VDE 0110 deel 1
Omgevingsdata	
Operationele temperatuur	-20 ... +60°C
Opslagtemperatuur	-30 ... +70°C
Type bescherming	IP 20



Let op!

Leef de voorgeschreven afzekering absoluut na, want alleen dan wordt er veilig uitgeschakeld als er een fout plaatsvindt.



Let op!

- Bovenop de systeemreactietijd van max. 40ms moeten nog de reactietijden van de veilige AS-interface-sensor-slave, van de voor de bewaking gebruikte sensor, van de veilige AS-interface-Actuator-slave en de daarvoor gebruikte actuator worden bijgeteld.

Let u er s.v.p. op dat door de afstelling van de bewakingsmonitor eveneens langere reactietijden kunnen ontstaan.

- De systeemreactietijden van de aaneengeschakelde AS-interface componenten worden opgeteld bij koppeling van AS-interface-netwerken.

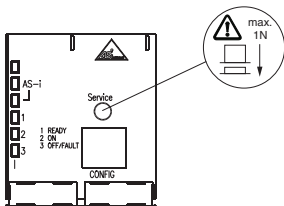

4 Elektrische Installatie



Let op!

Elektrische installatie alleen door daarvoor opgeleid en deskundig personeel laten uitvoeren.



Let op!

Elke veilige AS-interface slave moet minimaal eenmaal per jaar worden bediend en het schakelgedrag moet worden gecontroleerd door het bekijken van de output circuit van de AS-interface bewakingsmonitor.

Na het omwisselen van een veilige AS-i slave moet de correcte werking van de nieuwe slave worden gecontroleerd en bij het omwisselen van een AS-i bewakingsmonitor de correcte werking van de nieuwe AS-i bewakingsmonitor.

Verplaats voedings- en waarschuwingskabels en ook AS-i-buskabels gescheiden van krachtstroomkabels.

Gebruik in de schakelkast bij het beschermen een passende vonkblussing.

Let bij de aandrijfmotoren en -remmen op de installatie-aanwijzingen in de bijbehorende handleidingen.

Maximale kabellengte voor de AS-i-buskabel is 100 m. Gebruik AS-i-repeaters als de kabellengte langer is dan 100 m.



Let op!

Het AS-interface-voedingsapparaat van de AS-interfacecomponenten moet over een veilige voedings scheiding volgens IEC 60742 beschikken en kortdurende voedingsuitval tot 20 ms overbruggen. Het voedingsapparaat voor de 24 V voeding moet eveneens over een veilige voedings scheiding volgens IEC 60742 beschikken en kortdurende voedingsuitval tot 20 ms overbruggen.

LED meldingen ASM

LED	Kleur	Verklaring
AS-i 1	uit	Geen voeding
	groen, continu brandend	AS-interfacevoeding aanwezig
AS-i 2	uit	Normale werking
	rood, continu brandend	Communicatiefout
AS-iS 1	uit	Geen voeding
	groen, continu brandend	AS-interfacevoeding aanwezig
AS-iS 2	uit	Normale werking
	rood, continu brandend	Communicatiefout
1 READY (elk output circuit)	uit	–
	geel, continu brandend	Aanloop-/nieuwe aanloopblokkering actief
	geel, knipperend	Externe test noodzakelijk / bevestiging / inschakelvertraging actief
2 ON (elk output circuit)	uit	Contacten van de output schakelelement open
	groen, continu brandend	Contacten van de output schakelelement gesloten
	groen, knipperend	Vertragingstijd loopt bij stopcategorie 1
3 OFF/ FAULT (elk output circuit)	uit	Contacten van de output schakelelement gesloten
	rood, continu brandend	Contacten van de output schakelelement open
	rood, knipperend	Fout op vlak van de bewaakte AS-interfacecomponenten

LED	Kleur	Verklaring
1 READY 2 ON 3 OFF/ FAULT (elk out- put circuit)	tegelijktijdig snel knipperend	Interne apparaatfout, foutmelding via software asimon op- vraagbaar

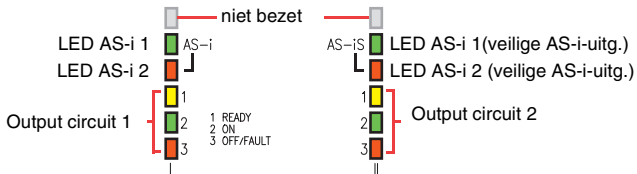

Afb. 4.0-1: LED-meldingen in het apparaat

Connectortoewijzing **AS-i-bewakingsmonitor ASM1/1 en ASM1E/1**

Con- nector	Signaal / Beschrijving	Elektrische aansluiting
AS-i+	Aansluiting aan de AS-interfacebus	
AS-i-		
L+	+24V DC / voedingsspanning	
M	GND / referentie-aarde	
FE	Beschermende aarde	
1.Y1	EDM 1 / Input retourcircuit	
1.Y2	Start 1 / Start-input	
1.13 ¹⁾	Output schakelement 1	
1.14		
1.23 ¹⁾	Output schakelement 2	
1.24		
1.32	Melding output "Safety on"	

1) Afzekering overeenkomstig technische data

Connectortoewijzing AS-i-bewakingsmonitor ASM1/2 en ASM1E/2

Con- nector	Signaal / Beschrijving	Elektrische aansluiting
AS-i+	Aansluiting aan de AS-interface- bus	
AS-i-		
L+	+24V DC / voedingsspanning	
M	GND / referentie-aarde	
FE	Beschermende aarde	
1.Y1	EDM 1 / Input retourcircuit, output circuit 1	
1.Y2	Start 1 / Start-input, output circuit 1	
1.13 ¹⁾	Output schakelement 1, output circuit 1	
1.14		
1.23 ¹⁾	Output schakelement 2, output circuit 1	
1.24		
1.32	Melding output 1 "Safety on", output circuit 1	
2.Y1	EDM 2 / input retourcircuit, output circuit 2	
2.Y2	Start 2 / Start-input, output circuit 2	
2.13 ¹⁾	Output schakelement 1, output circuit 2	
2.14		
2.23 ¹⁾	Output schakelement 2, output circuit 2	
2.24		
2.32	Melding output 2 "Safety on", output circuit 2	

1) Afzekering overeenkomstig technische data

Connectortoewijzing AS-i-bewakingsmonitor ASM2E/1 en ASM2E/2

Connector	Signaal / beschrijving	Elektrische aansluiting
AS-i+	Aansluiting aan de AS-interface-bus	
AS-i-		
AS-iS+	veilige AS-Interface-input voor actuator-bewaking of koppeling van een andere AS-interfacenetwerk	
AS-iS-		
L+	+24V DC / voedingsspanning	
M	GND / referentie-aarde	
FE	Beschermende aarde	
1.Y1	EDM 1 / input retourcircuit, output circuit 1	
1.Y2	Start 1 / Start-input, output circuit 1	
1.13 ¹⁾	Output schakelelement 1, output circuit 1	
1.14		
1.23 ¹⁾	Output schakelelement 2, output circuit 1	
1.24		
1.32	Melding output 1 "Safety on", output circuit 1	
2.Y1	EDM 2 / input retourcircuit, output circuit 2	
2.Y2	Start 2 / Start-input, output circuit 2	
2.13 ¹⁾	Output schakelelement 1, output circuit 2 (alleen ASM2E/2!)	
2.14		
2.23 ¹⁾	Output schakelelement 2, output circuit 2 (alleen ASM2E/2!)	
2.24		
2.32	Melding output 2 "Safety on", output circuit 2	

1) Afzekering overeenkomstig technische data

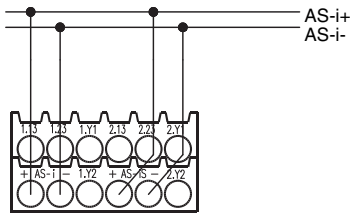

Afb. 4.0-2: Aansluiting bij actuator-bewaking

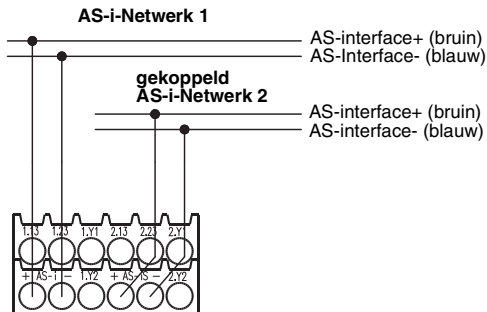

Afb. 4.0-3: Koppeling bij AS-i-Netwerken

5 Montage

De montage van de bewakingsmonitor vindt plaats door hem op een 35 mm standaardrails volgens EN 50022 vast te zetten.

- Voor het verwijderen van de monitor vast tegen de bovenste railsgeleider drukken en uitlichten.

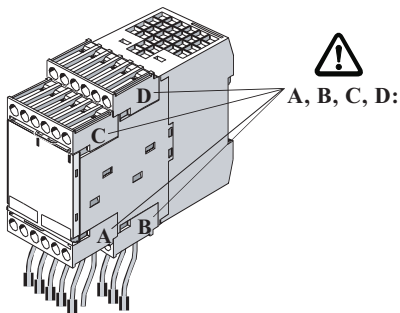

Afb. 5.0-1: Montage van de bewakingsmonitor

- Voor het losmaken van de gecodeerde aansluitconnectoren bevestigingsplaatjes **a** wegdrücken en connector naar voren wegtrekken.
- Bij het bevestigen moet de aansluitconnector met een klik worden vastgezet.



1. $U = 0\text{ V}$
2. a, b, c, d

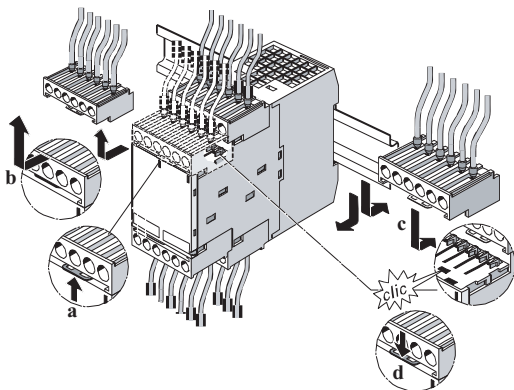

Afb. 5.0-2: Gecodeerde aansluitconnectoren verwijderen en bevestigen

- Afdekkap plaatsen en plomben in stappen 1-5.

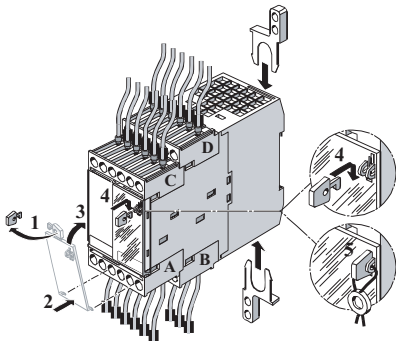

a = Plombeerbare afdekkap als beveiliging tegen onbevoegd instellen en als ESD-bescherming (onderdeel van de levering).

Afb. 5.0-3: Monteren en plomben van de afdekkap



Overige aanwijzingen zie aansluit- en gebruikshandleiding AS-i bewakingsmonitor.

6 Wisselen van de AS-i-bewakingsmonitor

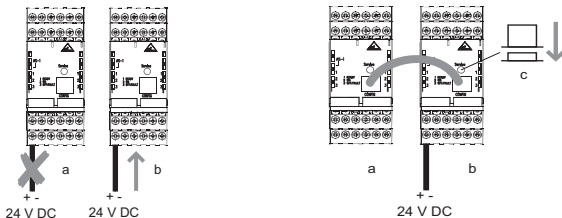

- 1 Haal de defecte (a) AS-i-bewakings-2 monitor van de voeding af en sluit de nieuwe (b) aan. Verbind de defecte (a) en de nieuwe (b) AS-i-bewakingsmonitor via de RJ45/RJ45-kabel en druk op de servicetoets (c) van de nieuwe (b) AS-i-bewakingsmonitor.

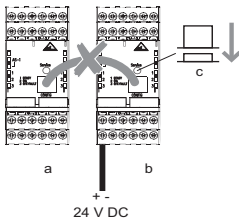

- 2 Koppel de beide AS-i-bewakingsmonitoren van elkaar en druk opnieuw op de servicetoets.

7 Bestelomschrijvingen

Art.-nr.	Artikel	Beschrijving
580020	ASM1/1	AS-i bewakingsmonitor, 1 deblokkeercircuit
580021	ASM1/2	AS-i bewakingsmonitor, 2 deblokkeercircuits
580024	ASM1E/1	AS-i bewakingsmonitor, 1 deblokkeercircuit; uitgebr. functionaliteit
580025	ASM1E/2	AS-i bewakingsmonitor, 2 deblokkeercircuits; uitgebr. functionaliteit
580028	ASM2E/1	AS-i bewakingsmonitor, 1 deblokkeercircuit, 1 beveiligde AS-i output, uitgebr. functionaliteit
580029	ASM2E/2	AS-i bewakingsmonitor, 2 deblokkeercircuits, 1 beveiligde AS-i output, uitgebr. functionaliteit
580055	ASM1E-m/1	AS-i bewakingsmonitor, 1 deblokkeercircuit, uitgebr. functionaliteit, Muting
580056	ASM1E-m/2	AS-i bewakingsmonitor, 2 deblokkeercircuits, uitgebr. functionaliteit, Muting
580057	ASM2E-m/1	AS-i bewakingsmonitor, 1 deblokkeercircuit, 1 beveiligde AS-i output, uitgebr. functionaliteit, Muting
580058	ASM2E-m/2	AS-i bewakingsmonitor, 2 deblokkeercircuits, 1 beveiligde AS-i output, uitgebr. functionaliteit, Muting

8 Bestelomschrijvingen accessoires

Art.-nr.	Artikel	Beschrijving
580032	ASM-SWC	ASM-Ingebruiknameset voor ASM1, ASM1E en ASM2E bestaat uit: configuratie- en diagnosesoftware asimon, aansluit- en gebruikshandleiding, gebruikershandleiding software op cd, programmeerkabel, apparaatwissel-datakabel
50104078	ASM1-PK	ASM1-stuurkabel
50104079	ASM1-DK	ASM1-apparaatwissel-datakabel



AS-interface säkerhetsmonitorn får endast användas i elrum/ elskåp med minst skyddsklass IP54.



Korrekt anslutning, driftsättning och byte av AS-interface säkerhetsmonitorn förutsätter att anslutnings- och bruksanvisningarna samt bruksmanualen av konfigurerings- och diagnosprogrammet asimon (se beställinformation tillbehör) har lästs.



Varning:

Farlig elektrisk spänning!

Risk för elektriska stötar och brännskador.

Gör anläggningen och enheten spänningslösa innan arbetena påbörjas.



Beroende på vilka säkerhetskomponenter som valts kan hela säkerhetssystemet även klassas i en lägre säkerhetskategori!



1 Användningsområde

Övervakning av säkerhetsrelaterade ASi-slavar (t ex nödstopp) via konfigureringsprogrammet ASiMon inom ett ASi-system.

Beroende på vilken variant som används är den andra frikopplingskretsen utförd som säker ASi-utgång med eller utan relä.

Vid ett fullständigt utbyggt system: Säker fränkoppling med en reaktionstid på maximalt 40 ms. Upp till 31 säkerhetsrelaterade ASi-slavar kan anslutas.

Blandad drift av säkerhetsrelaterade och standard-ASi-komponenter.

Inom ett ASi-system kan flera ASi-säkerhetsmonitorer användas som vid behov gemensamt övervakar en säkerhetsrelaterad ASi-slav.

Godkänd för säkerhetsapplikationer upp till kategori 4 enligt ISO 13849-1 PLe.

2 Måttritning

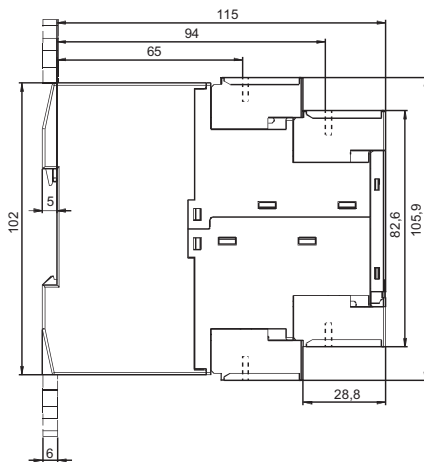
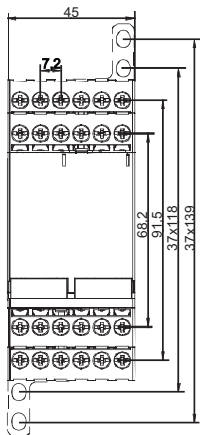

3 Tekniska data

Elektriska data

Driftspänning U_b	24V DC +/- 15%	
Resterande rippel	< 15%	
Märkdriftström	ASM1/1 och ASM1E/1:	150mA
	ASM1/2, ASM1E/2 och ASM2/1:	200mA
	ASM2E/2:	250mA
Tillkopplingstoppström	alla typer: 600mA	
Reaktionstid (säkerhetsteknisk)	< 40ms	
Fördröjning före start	< 10s	



ASi-data

ASi-profil	monitor 7.F
ASi-spänningsområde	18,5 ... 31,6V
ASi-strömförbrukning	< 45mA

Mekaniska data

Mått (b x h x d)	45mm x 105mm x 120mm	
Höljets material	polyamid PA 66	
Vikt	ASM1/1 och ASM1E/1:	ca 350g
	ASM2E/1:	ca 420g
	ASM1/2, ASM1E/2 och ASM2E/2:	ca 450g
Infästning	hakas fast på hattskena enligt EN 50022	

Anslutning

 Ø 5 ... 6 mm / PZZ	0,8 ... 1,2 Nm 7 ... 10.3 LB.IN
	1 x (0,5 ... 4,0) mm ² 2 x (0,5 ... 2,5) mm ²
	1 x (0,5 ... 2,5) mm ² 2 x (0,5 ... 1,5) mm ²
AWG	2 x 20 ... 14

Konfigureringsgränssnitt

RS 232	9600 baud, ingen paritet, 1 startbit, 1 stoppbit, 8 databitar
In- och utgångar	
Ingång "Start"	Optokopplaringång (hög-aktiv), ingångsström ca 10mA vid 24V DC
Ingång "återkopplingskrets" (EDM)	Optokopplaringång (hög-aktiv), ingångsström ca 10mA vid 24V DC
Meddelandeutgång "Safety on"	PNP-transistorutgång, 200mA, kortslutnings- och polaritetskydd
Säkerhetsutgång	Potentialfria slutkontakter, max kontaktbelastning: 1 A DC-13 vid 24V DC 3 A AC-15 vid 230V AC
Termisk överföringsström max	<u>ASM1/1, ASM1E/1 och ASM2E/1:</u> maximal summaström för alla utgångskopplings- element: 6 A dvs utgångskrets 1: 3 A per utgångskopplings- element <u>ASM1/2, ASM1E/2 och ASM2E/2:</u> max summaström för alla utgångskopplings- element: 8 A dvs utgångskrets 1: 3 A per utgångskopplings- element utgångskrets 2: 1 A per utgångskopplings- element eller utgångskrets 1: 2 A per utgångskopplings- element utgångskrets 2: 2 A per utgångskopplings- element
Säkring	externt med max 4 A MT
Överspanningskategori	3, för märkdriftspänning 300V AC enligt VDE 0110 del 1
Omgivningsdata	
Drifttemperatur	-20 ... +60°C
Förvaringstemperatur	-30 ... +70°C
Skyddsklass	IP 20



Varning!

Säkringen ska absolut motsvara anvisningen så att säker frångkoppling kan utföras när ett fel inträffar.



Varning!

- Utöver systemreaktionstiden på max 40ms ska även reaktionstiderna för de säkra ASi-sensorslavarna, den för övervakning använda sensorn, de säkra ASi-aktuatorslavarna och den härför använda aktuator adderas.
Observera: Genom parametring av säkerhetsmonitorn kan extra reaktionstider uppstå.
- De länkade ASi-komponenternas systemreaktionstider adderas när ASi-nät kopplas ihop.

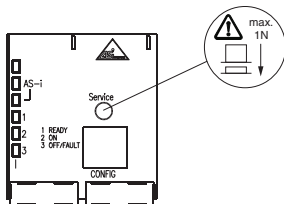

4 Elektrisk installation



Varning!

Elinstallationsarbeten får endast utföras av instruerade experter.



Varning!

Varje säkerhetsrelaterad ASi-slav ska påverkas minst en gång om året och reaktionen av AS-interface säkerhetsmonitors utgångskretsar ska iakttas.

Kontrollera alltid att den nya enheten fungerar korrekt när en defekt säkerhetsrelaterad slav eller en defekt säkerhetsmonitor har bytts ut.

Matningsledningar, signalledningar och ASi-bussledningar ska dras separat från kraftledningar.

I elskåpet ska en lämplig gnistsläckning användas i samband med kontaktorer.

Beakta anvisningarna i tillverkarnas bruksmanualer när driftsmotorer och driftsbromsar installeras.

Den maximala ledningslängden för ASi-bussledningen är 100 m. Om längre ledningar behövs ska ASi-överdrag användas.



Varning!

ASi-nåtdelen för matning av ASi-komponenterna måste ha säker frånskiljning från elnätet enligt IEC 60742 och överbrygga korta nätspänningsbortfall på upp till 20ms. Även nåtdelen för 24 V matning måste ha säker frånskiljning från elnätet enligt IEC 60742 och överbrygga korta nätspänningsbortfall på upp till 20ms.

LED indikatorernas ASM

LED	Färg	Innebörd
AS-i 1	från	Ingen matning
	grön, permanent	ASi-matning finns
AS-i 2	från	Normal drift
	röd, permanent	Kommunikationsfel
AS-iS 1	från	Ingen matning
	grön, permanent	ASi-matning finns
AS-iS 2	från	Normal drift
	röd, permanent	Kommunikationsfel
1 READY (per utgångskrets)	från	–
	gul, permanent	Start-/omstartblockering aktiv
	gul, blinkande	Externt test krävs / kvittering / tillkopplingsfördröjning aktiv
2 ON (per utgångskrets)	från	Utgångskopplingselementets kontakter öppna
	grön, permanent	Utgångskopplingselementets kontakter slutna
	grön, blinkande	Fördröjningstid går vid stoppkategori 1
3 OFF/ FAULT (per utgångskrets)	från	Utgångskopplingselementets kontakter slutna
	röd, permanent	Utgångskopplingselementets kontakter öppna
	röd, blinkande	Fel på de övervakade ASi-komponenternas nivå
1 READY 2 ON 3 OFF/ FAULT (per utgångskrets)	samtidigt snabbt blinkande	Internt apparatfel, felmeddelande kan hämtas ut med hjälp av programmet asimon

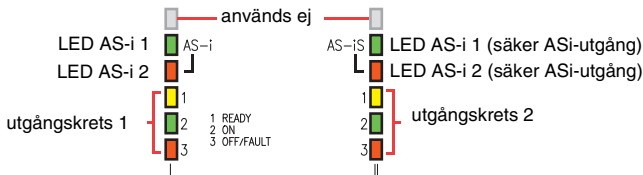

Fig. 4.0-1: LED-visningar i enheten

Tilldelning av plintkontakter AS-interface Säkerhetsmonitor ASM1/1 och ASM1E/1

Kontakt	Signal / beskrivning	Elektrisk anslutning
AS-i+	Anslutning till ASi-bussen	
AS-i-		
L+	+24V DC / matningsspänning	
M	GND / referensjord	
FE	Funktionsjord	
1.Y1	EDM 1 / ingång återkopplingskrets	
1.Y2	Start 1 / startingång	
1.13 ¹⁾	Utgångskopplingselement 1	
1.14		
1.23 ¹⁾	Utgångskopplingselement 2	
1.24		
1.32	Meddelandeutgång "Safety on"	

1) Säkring enligt Tekniska data

Tilldelning av plintkontakter AS-interface Säkerhetsmonitor ASM1/2 och ASM1E/2

Kontakt	Signal / beskrivning	Elektrisk anslutning
AS-i+	Anslutning till ASI-bussen	
AS-i-		
L+	+24V DC / matningsspänning	
M	GND / referensjord	
FE	Funktionsjord	
1.Y1	EDM 1 / ingång återkopplingskrets, utgångskrets 1	
1.Y2	Start 1 / startingång, utgångskrets 1	
1.13 ¹⁾	Utgångskopplingselement 1, utgångskrets 1	
1.14		
1.23 ¹⁾	Utgångskopplingselement 2, utgångskrets 1	
1.24		
1.32	Meddelandeutgång 1 "Safety on", utgångskrets 1	
2.Y1	EDM 2 / ingång återkopplingskrets, utgångskrets 2	
2.Y2	Start 2 / startingång, utgångskrets 2	
2.13 ¹⁾	Utgångskopplingselement 1, utgångskrets 2	
2.14		
2.23 ¹⁾	Utgångskopplingselement 2, utgångskrets 2	
2.24		
2.32	Meddelandeutgång 2 "Safety on", utgångskrets 2	

1) Säkring enligt Tekniska data

Tilldelning av plintkontakter AS-interface Säkerhetsmonitor ASM1/1 och ASM1E/2

Kontakt	Signal / beskrivning	Elektrisk anslutning
AS-i+	Anslutning till ASi-bussen	
AS-i-		
AS-iS+	Säker ASi-utgång för övervakning av aktuatorer och koppling av ett annat ASi-nät	
AS-iS-		
L+	+24V DC / matningsspänning	
M	GND / referensjord	
FE	Funktionsjord	
1.Y1	EDM 1 / ingång återkopplingskrets, utgångskrets 1	
1.Y2	Start 1 / startgång, utgångskrets 1	
1.13 1)	Utgångskopplingselement 1, utgångskrets 1	
1.14		
1.23 1)	Utgångskopplingselement 2, utgångskrets 1	
1.24		
1.32	Meddelandeutgång 1 "Safety on", utgångskrets 1	
2.Y1	EDM 2 / ingång återkopplingskrets, utgångskrets 2	
2.Y2	Start 2 / startgång, utgångskrets 2	
2.13 1)	Utgångskopplingselement 1, utgångskrets 2 (endast ASM2E/2!)	
2.14		

ENDAST ASM2E/2!

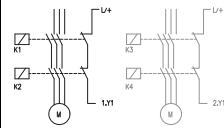

Kontakt	Signal / beskrivning	Elektrisk anslutning
2.23 ¹⁾	Utgångskopplingselement 2, utgångskrets 2 (endast ASM2E/2!)	
2.24		
2.32	Meddelandeutgång 2 "Safety on", utgångskrets 2	

1) Säkring enligt Tekniska data

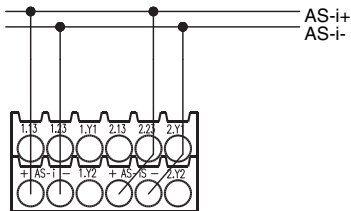

Fig. 4.0-2: Anslutning vid aktuatorövervakning

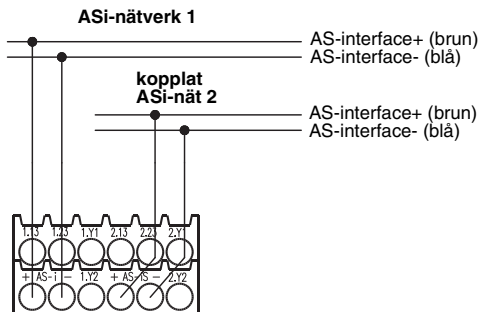

Fig. 4.0-3: Koppling i ASi-nätverk

5 Montering

Säkerhetsmonitorn monteras genom att snäppas fast på en normskena 35 mm enligt EN 50022.

- Monitorn kan tas bort från skenan genom att man trycker den kraftigt mot skenans övre del och lyfter ut den.

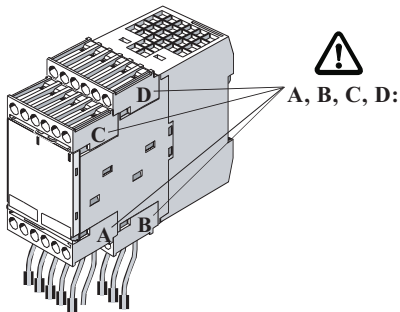

Fig. 5.0-1: Montering av säkerhetsmonitorn

- För att dra av de kodade kontakterna ska säkringsfälten **a** tryckas undan och kontakten dras ut framåt.
- När man skjuter på kopplingsplinten måste den hakas i med ett klickande ljud.



1. $U = 0\text{ V}$
2. a, b, c, d

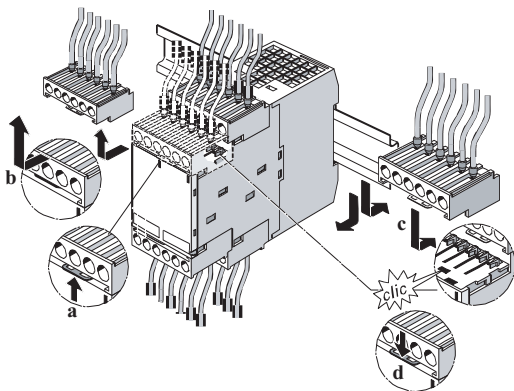
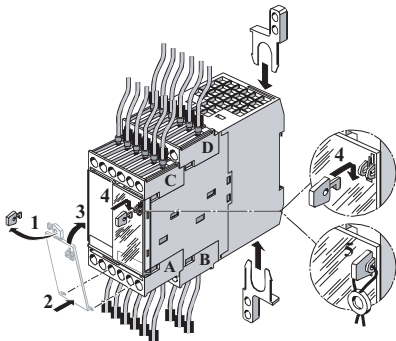

Fig. 5.0-2: Ta bort och skjuta på kodade kopplingsplintar

- Sätt på täcklocket och plombera det enligt steg 1-5.



a = plomberbart täcklock, skyddar mot obehöriga ändringar och som ESD-skydd (ingår i leveransomfånget)

Fig. 5.0-3: Montera och plombera täcklocket



Ytterligare information se anslutnings- och bruksmanualen för AS-interface säkerhetsmonitorn.

6 Byte av AS-interface säkerhetsmonitorn

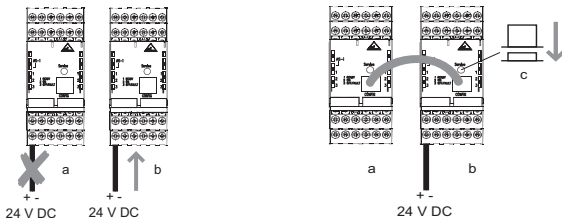

- 1 Skilj den defekta AS-interface säkerhetsmonitor (a) från elförsörjningen och anslut den nya säkerhetsmonitor (b). Anslut kabeln RJ45/RJ45 mellan defekt (a) och ny (b) säkerhetsmonitor och tryck serviceknappen (c) på den nya (b) AS-interface säkerhetsmonitor.

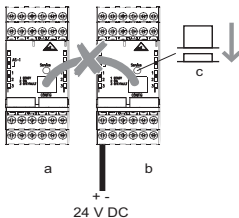

- 2 Ta bort kabeln mellan de båda AS-interface säkerhetsmonitorerna och tryck på serviceknappen igen.

7 Beställinformation

Artikelnr.	Artikel	Beskrivning
580020	ASM1/1	AS-interface säkerhetsmonitor, 1 frikopplingskrets
580021	ASM1/2	AS-interface säkerhetsmonitor, 2 frikopplingskretsar
580024	ASM1E/1	AS-interface säkerhetsmonitor, 1 frikopplingskrets; avancerad funktionalitet
580025	ASM1E/2	AS-interface säkerhetsmonitor, 2 frikopplingskretsar; avancerad funktionalitet
580028	ASM2E/1	AS-interface säkerhetsmonitor, 1 frikopplingskrets, 1 säker ASI-utgång, avancerad funktionalitet
580029	ASM2E/2	AS-interface säkerhetsmonitor, 2 frikopplingskretsar, 1 säker ASI-utgång; avancerad funktionalitet
580055	ASM1E-m/1	AS-interface säkerhetsmonitor, 1 frikopplingskrets, avancerad funktionalitet, Muting
580056	ASM1E-m/2	AS-interface säkerhetsmonitor, 2 frikopplingskretsar, avancerad funktionalitet, Muting
580057	ASM2E-m/1	AS-interface säkerhetsmonitor, 1 frikopplingskrets, 1 säker ASI-utgång, avancerad funktionalitet, Muting
580058	ASM2E-m/2	AS-interface säkerhetsmonitor, 2 frikopplingskretsar, 1 säker ASI-utgång, avancerad funktionalitet, Muting

8 Beställinformation tillbehör

Artikelnr.	Artikel	Beskrivning
580032	ASM-SWC	ASM-driftsättningspaket för ASM1, ASM1E och ASM2E innehåller konfigurerings- och diagnosprogrammet asimon, anslutnings- och bruksanvisningen, bruksmanualen, programvara på CD, programmeringskabeln, dataöverföringskabeln.
50104078	ASM1-PK	ASM1-konfigureringskabeln
50104079	ASM1-DK	ASM1-dataöverföringskabel