

## Technical data sheet · Actuator sensor interface

CANopen field bus cables



<b>Identification</b>	Type	STG5-M12/KUG5-M12/CAN 1,5M-PUR
	Part-No.	475915

<b>Description</b>	Male-female M12 straight with PUR cable, shielded 360° self-locking screwed connection c-track compatible, halogen free
--------------------	---

<b>Technical data</b>	
Rated voltage $U_N$	AC/DC 24 V
Rated voltage max.	30 V
Rated current	4 A
Pole number	5
Cable length	1.5 m
Coding	A
Shielding	360°

<b>General</b>	
Form male 1	M 12 Male straight
Form male 2	M 12 Female straight

29.04.2017 – Subject to technical modification

Part-No. 475915

USA: LUTZE INC.

13330 South Ridge Drive • Charlotte, NC 28273, USA  
Tel. +1 (704) 504-0222 • Fax +1 (704) 504-0223  
www.lutze.com • info@lutze.com

United Kingdom: LÜTZE Ltd.

Unit 3, Sandy Hill Park  
Sandy Way, Amington • GB-Tamworth, Staffs B77 4DU  
Tel. +44 (0)1827 31333-0 • Fax +44 (0)1827 31333-2  
www.lutze.com • sales.gb@lutze.co.uk



SYSTEMATIC TECHNOLOGY

## Technical data sheet - Actuator sensor interface

---

Nominal insulation voltage	60 V
Test voltage	1500 V
Degree of pollution	3
Insulation resistance	> 1000 MΩ × km
Contact resistance	< 5 mΩ
Flamability according to UL 94	V0
Protection class	IP65/67
Housing material	TPU
Colour of the housing	black
Contact material	CuSn, gold-plated
Thread material	Zinc die-casting, nickel-plated
Material sealing ring	NBR
Mounting	Breakaway torque 0.4 Nm
Number of conductors/cross-section	2 x AWG22/19 + 2 x AWG24/19 + drain wire AWG22/19
Number of conductors	5
Jacket material	PUR
Jacket color	violet RAL 4001
Conductor insulation	PE
Outer Ø	6.7 mm
Bending radius	15 × D
Minimum bending radius moving	15×D
Storage temperature range	-40 °C ... +90 °C
Temperature range connector	-25 °C ... +90 °C
Temperature range fixed	-40 °C ... +80 °C
Temperature range moving	-20 °C ... +75 °C
Weight	0.125 kg/piece
PU	1 Quantity

---

### C-track chain properties

Conduction properties (TYPE A+B+C)

Type A

PUR halogen free for extreme demands

- Very good chemical stability
- Very resistant to oils and lubricants
- Very high abrasion resistance
- Halogen free
- Silicone free, free of paint wetting impairment substances
- Resistant to microbes and hydrolysis
- Good UV stability

29.04.2017 – Subject to technical modification

Part-No. 475915

USA: LUTZE INC.

13330 South Ridge Drive • Charlotte, NC 28273, USA

Tel. +1 (704) 504-0222 • Fax +1 (704) 504-0223

www.lutze.com • info@lutze.com

United Kingdom: LÜTZE Ltd.

Unit 3, Sandy Hill Park

Sandy Way, Amington • GB-Tamworth, Staffs B77 4DU

Tel. +44 (0)1827 31333-0 • Fax +44 (0)1827 31333-2

www.lutze.com • sales.gb@lutze.co.uk



SYSTEMATIC TECHNOLOGY

# Technical data sheet · Actuator sensor interface

## Dimensions

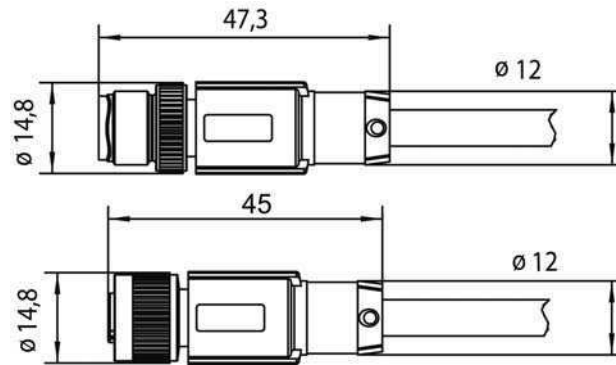

## PIN assignment

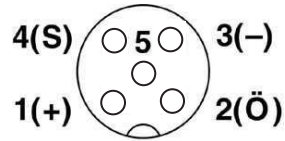

## Circuit diagram

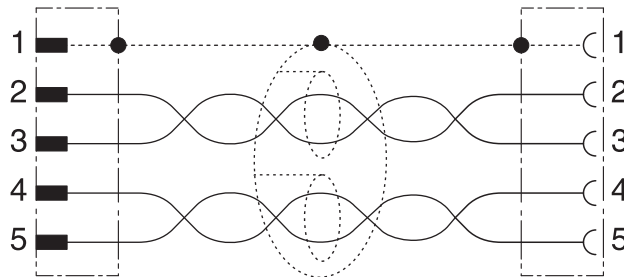

29.04.2017 – Subject to technical modification

Part-No. 475915

USA: LUTZE INC.

13330 South Ridge Drive · Charlotte, NC 28273, USA

Tel. +1 (704) 504-0222 · Fax +1 (704) 504-0223

www.lutze.com · info@lutze.com

United Kingdom: LÜTZE Ltd.

Unit 3, Sandy Hill Park

Sandy Way, Amington · GB-Tamworth, Staffs B77 4DU

Tel. +44 (0)1827 31333-0 · Fax +44 (0)1827 31333-2

www.lutze.com · sales.gb@lutze.co.uk



SYSTEMATIC TECHNOLOGY

**Symbols**



---

**Accessories**

Torque setting tool M 12

**Part No.**

490091

**Type**

DM-SET M12

**PU**

1

29.04.2017 – Subject to technical modification

Part-No. 475915

USA: LUTZE INC.

13330 South Ridge Drive • Charlotte, NC 28273, USA  
Tel. +1 (704) 504-0222 • Fax +1 (704) 504-0223  
www.lutze.com • info@lutze.com

United Kingdom: LÜTZE Ltd.

Unit 3, Sandy Hill Park  
Sandy Way, Amington • GB-Tamworth, Staffs B77 4DU  
Tel. +44 (0)1827 31333-0 • Fax +44 (0)1827 31333-2  
www.lutze.com • sales.gb@lutze.co.uk