



Identification	Type	USB-2.0 A/A 5,0M PVC
	Part-No.	490081

Description	USB-panel connector for front installation with M22 thread
	USB connector Typ A on straight USB plug Type A with PVC cable Type: USB-2.0 A/A

Technical data	
Nominal voltage	AC/DC 5 V
Nominal voltage range	max. 30 V
Rated current	500 mA
Number of terminations	4
Cable length (m)	5.0 m
Transfer rate	max. 480 Mbit/s
USB standard	2.0
Contact type	1 : 1
Shielding	yes
Contact resistance	≤30 mΩ

General	
Form	USB-A
Rated insulation voltage (EN 50178)	30 V

13.12.2012 – Subject to technical modification

Part-No. 490081

USA: LUTZE INC.

13330 South Ridge Drive • Charlotte, NC 28273, USA
Tel. +1 (704) 504-0222 • Fax +1 (704) 504-0223
www.lutze.com • info@lutze.com

United Kingdom: LÜTZE Ltd.

Unit 3, Sandy Hill Park
Sandy Way, Amington • GB-Tamworth, Staffs B77 4DU
Tel. +44 (0)1827 31333-0 • Fax +44 (0)1827 31333-2
www.lutze.com • sales.gb@lutze.co.uk



Technical data sheet - Actuator sensor interface

Pollution degree	3
Insulation resistance	$\geq 100 \text{ M}\Omega$
Contact resistance	$\leq 30 \text{ m}\Omega$
Class of flammability according to UL 94	V0
Protection class	IP 65 in closed and IP 20 in inserted condition
Housing material	Connector: PA; plug: PBT, cover: TPU
Contact material	CuSn, gold-plated
Field installation	Front plate cutout D=22.5mm
Cable construction	Supply: 2×AWG24; Data: 2×AWG28
Cable jacket	PVC
Cable diameter	4.5 mm
Bending radius	15 x cable diameter
Storage temperature range	-25 °C – 80 °C
Operation temperature range	0 °C – 70 °C
Class of flammability according to UL 94	V0
Dimension	(D×T) 29.5 × 29 mm, installation depth appr. 70 mm
Mechanical service life	>100 insertion cycles
Weight (kg/piece)	0.110
PU	10

Dimensions

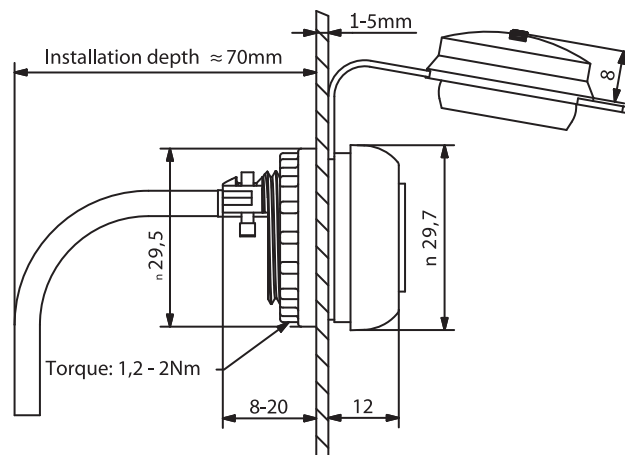

13.12.2012 – Subject to technical modification

Part-No. 490081

USA: LUTZE INC.

13330 South Ridge Drive • Charlotte, NC 28273, USA
Tel. +1 (704) 504-0222 • Fax +1 (704) 504-0223
www.lutze.com • info@lutze.com

United Kingdom: LÜTZE Ltd.

Unit 3, Sandy Hill Park
Sandy Way, Amington • GB-Tamworth, Staffs B77 4DU
Tel. +44 (0)1827 31333-0 • Fax +44 (0)1827 31333-2
www.lutze.com • sales.gb@lutze.co.uk



SYSTEMATIC TECHNOLOGY

Technical data sheet - Actuator sensor interface

PIN assignment

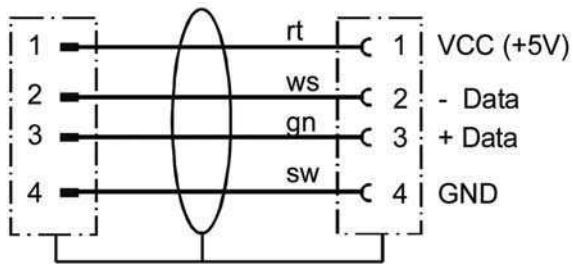

Mounting diagram

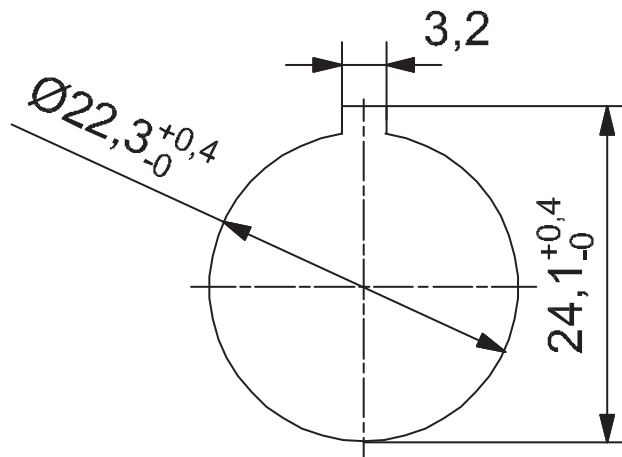

Accessories

Accessories	Article number	Type	PU
RJ-45 fitting bush	490075	RJ45 connector/ connector 8/8	1

Comments

Included in the delivery: captive safety cap

13.12.2012 – Subject to technical modification

Part-No. 490081

USA: LUTZE INC.

13330 South Ridge Drive • Charlotte, NC 28273, USA

Tel. +1 (704) 504-0222 • Fax +1 (704) 504-0223

www.lutze.com • info@lutze.com

United Kingdom: LÜTZE Ltd.

Unit 3, Sandy Hill Park

Sandy Way, Amington • GB-Tamworth, Staffs B77 4DU

Tel. +44 (0)1827 31333-0 • Fax +44 (0)1827 31333-2

www.lutze.com • sales.gb@lutze.co.uk



SYSTEMATIC TECHNOLOGY