



Identification	Type	LOCC Box FB 7-6400
	Part-No.	716400
Description	Electronic load monitoring up to DC 10 A Single-channel design, Adjustable current range: DC 1 A – 10 A Adjustable characteristics, fast, medium, slow 1, -2, -3	
Input	1-channel 1 pin switching	
Type of function	DC 12/24 V	
Rated voltage U_N	DC 10–30 V	
Operation voltage range	10 – 30 V	
Input voltage range	DC 10 A	
Rated current I_N	DC 40 A over Cu-rails 10 × 3 mm	
Supply current	internal electronics	
Reverse voltage protection	screwless contact slide	
Connection type input		
Control input (Set / Reset)	DC 12/24 V acc. to EN 61131	
Signal level	Pulse with falling edge >100 ms, <800 ms	
OFF	Pulse with falling edge > 1 s	
ON		

25.08.2017 – Subject to technical modification

Part-No. 716400

USA: LUTZE INC.

13330 South Ridge Drive · Charlotte, NC 28273, USA
Tel. +1 (704) 504-0222 · Fax +1 (704) 504-0223
www.lutze.com · info@lutze.com

United Kingdom: LÜTZE Ltd.

Unit 3, Sandy Hill Park
Sandy Way, Amington · GB-Tamworth, Staffs B77 4DU
Tel. +44 (0)1827 31333-0 · Fax +44 (0)1827 31333-2
www.lutze.com · sales.gb@lutze.co.uk



SYSTEMATIC TECHNOLOGY

Technical data sheet - Load monitoring

Output

Switching element	MosFet
Output current	max. DC 10 A
Voltage drop	<170 mV (10 A)
Status display output	LED green: operating voltage present, no error LED red: error in load circuit
Switch-on capacity	10000 µF
Current range	1 A – 10 A (adjustable via switch in 1 A steps)
Characteristic	fast-acting (1), medium (2), slow 1 (3), slow 2 (4), slow 3 (5) see 'characteristic curves'

Signal output

Signal level	DC 12/24 V: operating voltage on standby, no error, DC 0 V: error, output switched off
Switching element	Transistor, collector with pull-up resistance

General

Operation temperature range	-25 °C ... +50 °C
Storage temperature range	-40 °C ... +85 °C
Dimensions (w × h × d)	8.1 × 114.5 × 116.0 mm
Housing material	PA 6.6 (UL 94 V-0, NFF I2, F2)
Colour of the housing	basalt grey
Mounting	DIN rail mountable TS35 (EN 60715)
MTBF	690000 h
Protection class	IP20
Installation position	any
Connection device	Spring terminal 0.25 mm ² – 2.5 mm ²
Weight	0.120 kg/piece
Approvals	cULus (E135145) GL
Standards	EN 60950-1 EN 61131-1, 2 EN 61000 EN 60947-4-1 EN 55022
PU	1 piece

25.08.2017 – Subject to technical modification

Part-No. 716400

USA: LUTZE INC.

13330 South Ridge Drive • Charlotte, NC 28273, USA
Tel. +1 (704) 504-0222 • Fax +1 (704) 504-0223
www.lutze.com • info@lutze.com

United Kingdom: LÜTZE Ltd.

Unit 3, Sandy Hill Park
Sandy Way, Amington • GB-Tamworth, Staffs B77 4DU
Tel. +44 (0)1827 31333-0 • Fax +44 (0)1827 31333-2
www.lutze.com • sales.gb@lutze.co.uk



SYSTEMATIC TECHNOLOGY

Technical data sheet · Load monitoring

Dimensions

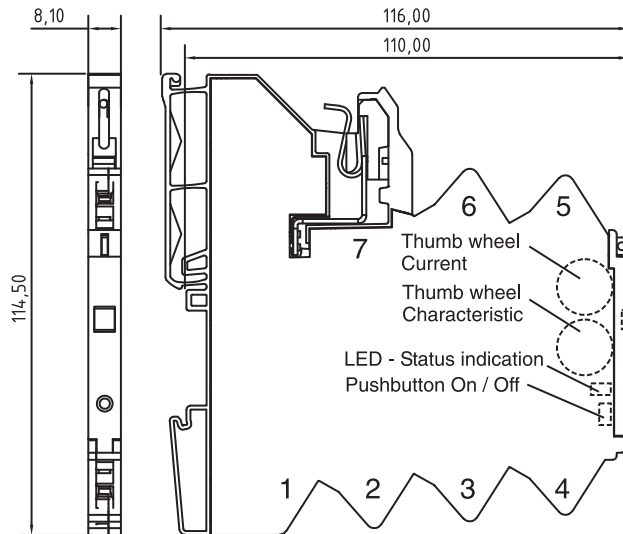

PIN assignment

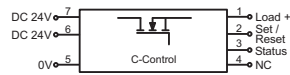

- 1: + Output
- 2: Control input (Set/Reset)
- 3: Status output
- 4: NC
- 5: 0V
- 6: + Supply (alternative)
- 7: + Supply

1: Characteristic fast

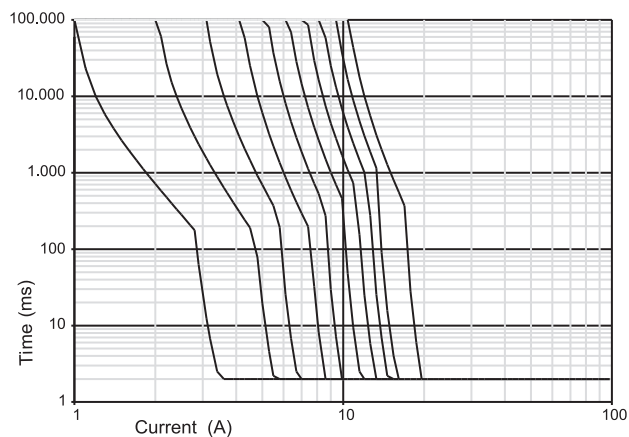

25.08.2017 – Subject to technical modification

Part-No. 716400

USA: LUTZE INC.

13330 South Ridge Drive · Charlotte, NC 28273, USA

Tel. +1 (704) 504-0222 · Fax +1 (704) 504-0223

www.lutze.com · info@lutze.com

United Kingdom: LÜTZE Ltd.

Unit 3, Sandy Hill Park

Sandy Way, Amington · GB-Tamworth, Staffs B77 4DU

Tel. +44 (0)1827 31333-0 · Fax +44 (0)1827 31333-2

www.lutze.com · sales.gb@lutze.co.uk



SYSTEMATIC TECHNOLOGY

Technical data sheet · Load monitoring

2: Characteristic medium

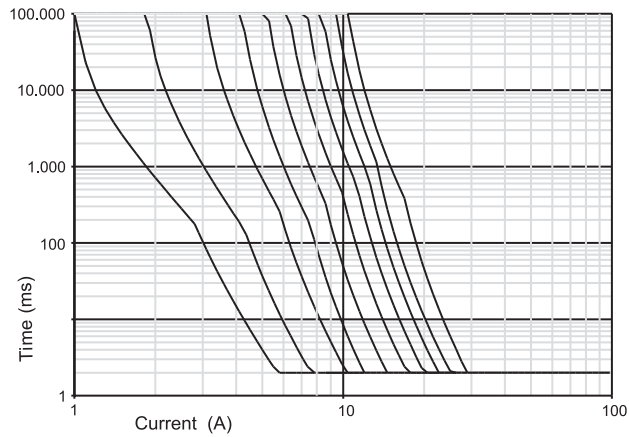

3: Characteristic slow-1

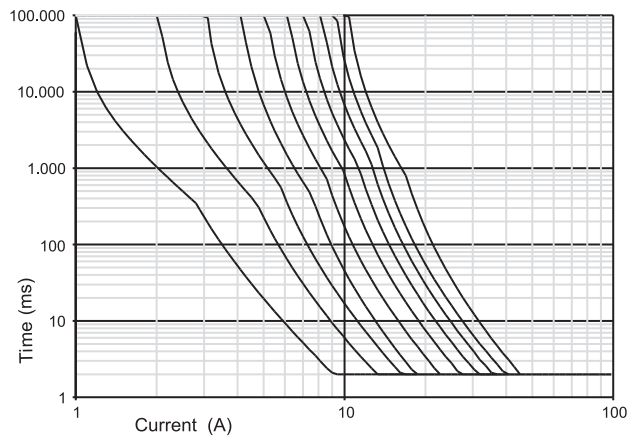

4: Characteristic slow-2

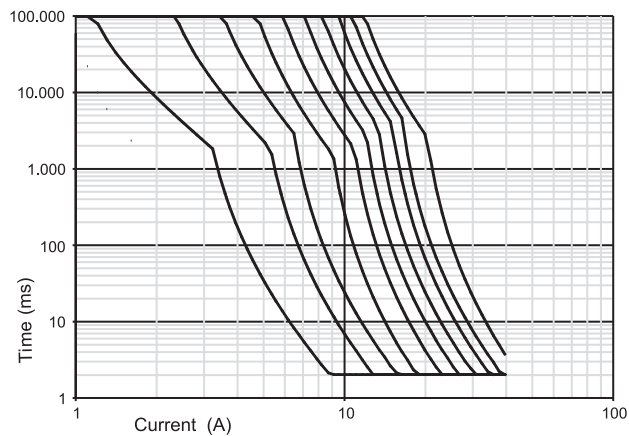

25.08.2017 – Subject to technical modification

Part-No. 716400

USA: LUTZE INC.

13330 South Ridge Drive · Charlotte, NC 28273, USA

Tel. +1 (704) 504-0222 · Fax +1 (704) 504-0223

www.lutze.com · info@lutze.com

United Kingdom: LÜTZE Ltd.

Unit 3, Sandy Hill Park

Sandy Way, Amington · GB-Tamworth, Staffs B77 4DU

Tel. +44 (0)1827 31333-0 · Fax +44 (0)1827 31333-2

www.lutze.com · sales.gb@lutze.co.uk



SYSTEMATIC TECHNOLOGY

5: Characteristic slow-3

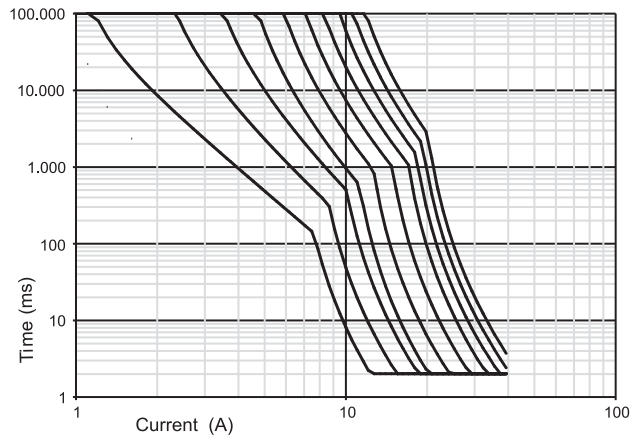

25.08.2017 – Subject to technical modification

Part-No. 716400

USA: LUTZE INC.

13330 South Ridge Drive · Charlotte, NC 28273, USA
Tel. +1 (704) 504-0222 · Fax +1 (704) 504-0223
www.lutze.com · info@lutze.com

United Kingdom: LÜTZE Ltd.

Unit 3, Sandy Hill Park
Sandy Way, Amington · GB-Tamworth, Staffs B77 4DU
Tel. +44 (0)1827 31333-0 · Fax +44 (0)1827 31333-2
www.lutze.com · sales.gb@lutze.co.uk



SYSTEMATIC TECHNOLOGY

Signal output

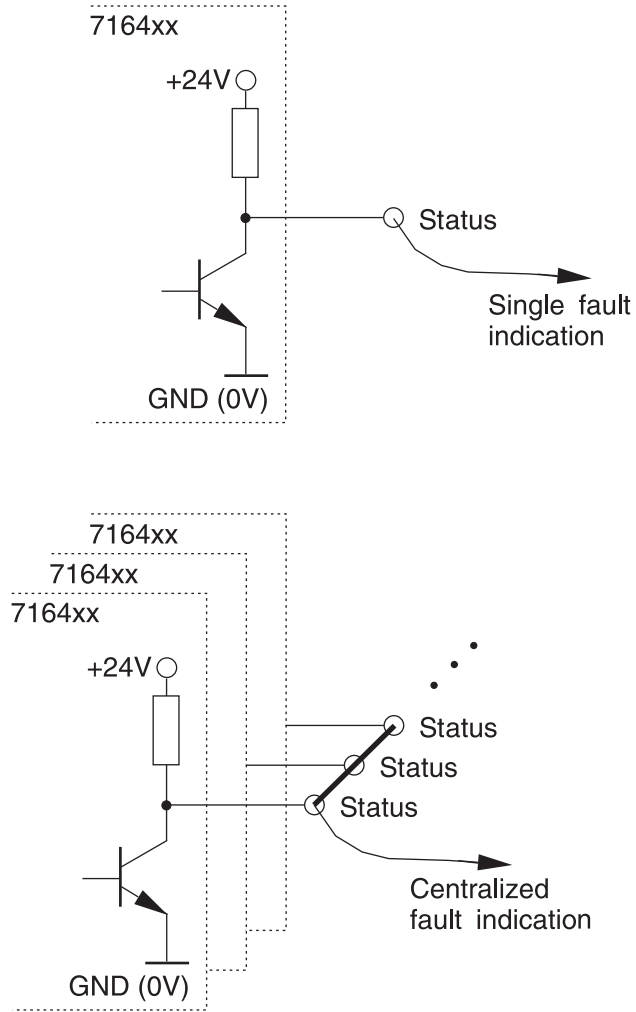

25.08.2017 – Subject to technical modification

Part-No. 716400

USA: LUTZE INC.

13330 South Ridge Drive · Charlotte, NC 28273, USA
Tel. +1 (704) 504-0222 · Fax +1 (704) 504-0223
www.lutze.com · info@lutze.com

United Kingdom: LÜTZE Ltd.

Unit 3, Sandy Hill Park
Sandy Way, Amington · GB-Tamworth, Staffs B77 4DU
Tel. +44 (0)1827 31333-0 · Fax +44 (0)1827 31333-2
www.lutze.com · sales.gb@lutze.co.uk