



Identification	Type	LOCC-Box-EC-I-C
	Part-No.	716407.xxxx
	See order code!	

Description	Electronic load monitoring up to DC 10 A Single channel version, fixed current range: DC 1 A - 10 A (see order code) Fixed characteristic: fast, medium, slow 1, -2, -3 (see order code)
--------------------	--

Input	
Rated voltage U_N	DC 12/24 V
Operation voltage range	DC 10–30 V
Input voltage range	– 30 V
Rated current I_N	DC 10 A
Supply current	DC 40 A over Cu-rails 10 × 3 mm
Reverse voltage protection	internal electronics
Connection type input	screwless contact slide

Output	
Switching element	MosFet
Output current	max. DC 10 A
Voltage drop	<170 mV (10 A)
Status display output	LED green: operating voltage present, no error LED red: error in load circuit

25.08.2017 – Subject to technical modification

Part-No. 716407.xxxx

USA: LUTZE INC.

13330 South Ridge Drive · Charlotte, NC 28273, USA
Tel. +1 (704) 504-0222 · Fax +1 (704) 504-0223
www.lutze.com · info@lutze.com

United Kingdom: LÜTZE Ltd.

Unit 3, Sandy Hill Park
Sandy Way, Amington · GB-Tamworth, Staffs B77 4DU
Tel. +44 (0)1827 31333-0 · Fax +44 (0)1827 31333-2
www.lutze.com · sales.gb@lutze.co.uk



Technical data sheet - Load monitoring

Switch-on capacity	10000 μ F
Current range	1 A – 10 A (see order code)
Characteristic	fast (1), medium (2), slow 1 (3), slow 2 (4), slow 3 (5) (see order code), see 'Characteristic curves'

Signal output

Signal level	DC 12/24 V: operating voltage on standby, no error, DC 0 V: error, output switched off and manual "OFF"
Switching element	Transistor, collector with pull-up resistance

General

Operation temperature range	-25 °C ... +50 °C
Storage temperature range	-40 °C ... +85 °C
Dimensions (w × h × d)	8.1 × 114.5 × 116.0 mm
Housing material	PA 6.6 (UL 94 V-0, NFF I2, F2)
Mounting	DIN rail mountable TS35 (EN 60715)
Protection class	IP20
Installation position	any
Connection device	Spring terminal 0.25 mm ² – 2.5 mm ²
Weight	0.120 kg/piece
Approvals	cULus (E135145)
Standards	EN 60950-1 EN 61131-1, 2 EN 61000 EN 60947-4-1 EN 55022
PU	1 piece

25.08.2017 – Subject to technical modification

Part-No. 716407.xxxx

USA: LUTZE INC.

13330 South Ridge Drive • Charlotte, NC 28273, USA
Tel. +1 (704) 504-0222 • Fax +1 (704) 504-0223
www.lutze.com • info@lutze.com

United Kingdom: LÜTZE Ltd.

Unit 3, Sandy Hill Park
Sandy Way, Amington • GB-Tamworth, Staffs B77 4DU
Tel. +44 (0)1827 31333-0 • Fax +44 (0)1827 31333-2
www.lutze.com • sales.gb@lutze.co.uk



SYSTEMATIC TECHNOLOGY

Technical data sheet · Load monitoring

Dimensions

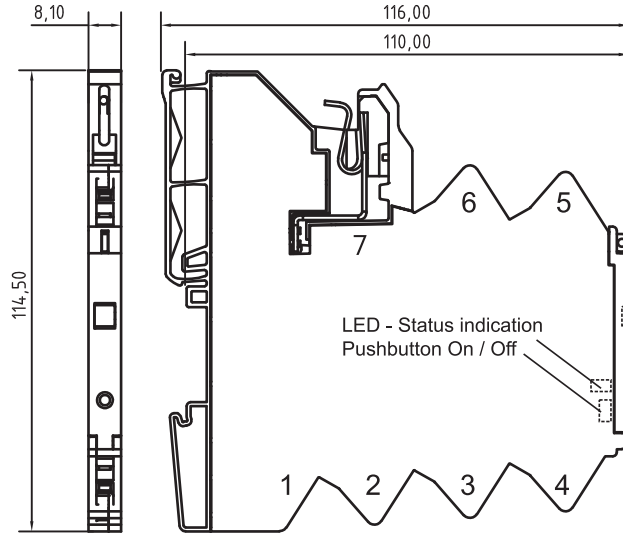

PIN assignment

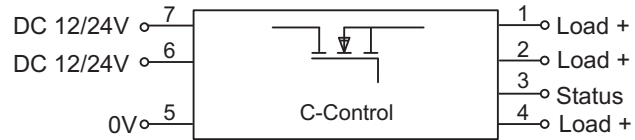

- 1: + Output
- 2: + Output
- 3: Status output
- 4: + Output
- 5: 0V
- 6: + Supply (alternative)
- 7: + Supply

1: Characteristic fast

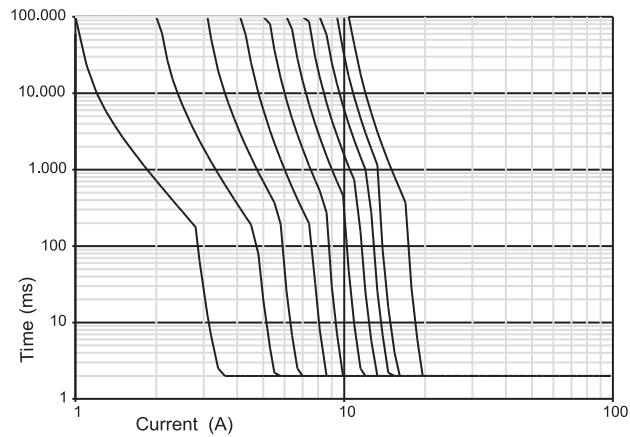

25.08.2017 – Subject to technical modification

Part-No. 716407.xxxx

USA: LUTZE INC.

13330 South Ridge Drive · Charlotte, NC 28273, USA

Tel. +1 (704) 504-0222 · Fax +1 (704) 504-0223

www.lutze.com · info@lutze.com

United Kingdom: LÜTZE Ltd.

Unit 3, Sandy Hill Park

Sandy Way, Amington · GB-Tamworth, Staffs B77 4DU

Tel. +44 (0)1827 31333-0 · Fax +44 (0)1827 31333-2

www.lutze.com · sales.gb@lutze.co.uk



SYSTEMATIC TECHNOLOGY

2: Characteristic medium

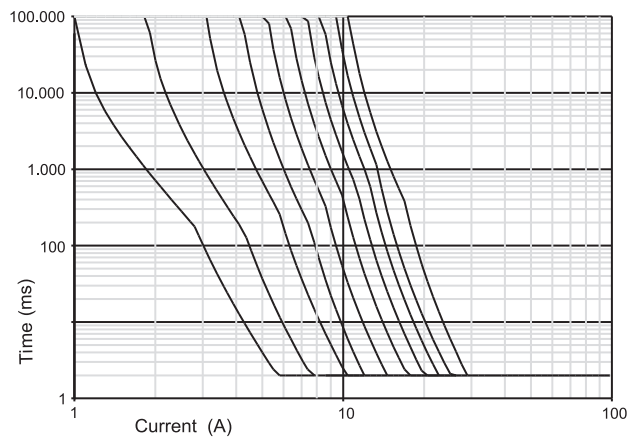

3: Characteristic slow-1

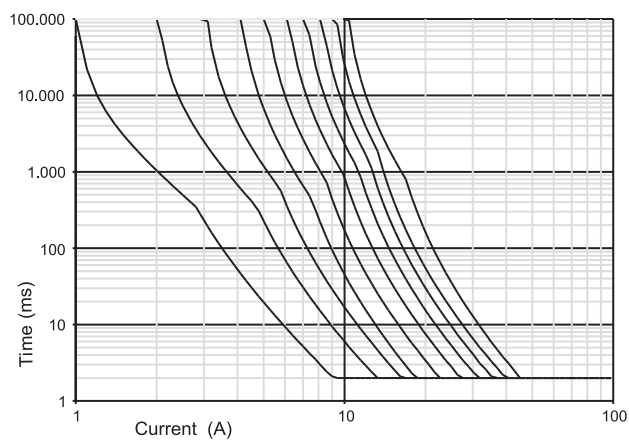

4: Characteristic slow-2

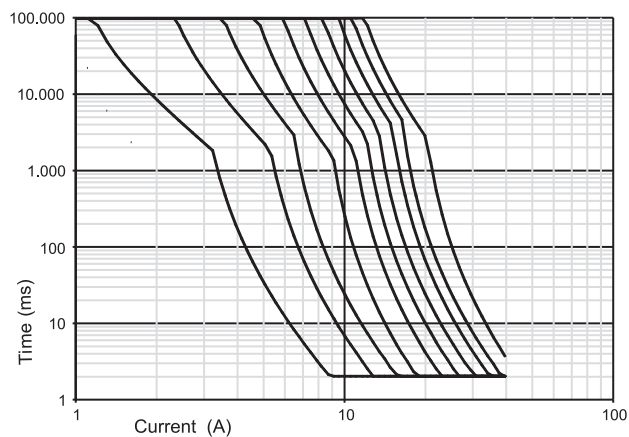

25.08.2017 – Subject to technical modification

Part-No. 716407.xxxx

USA: LUTZE INC.

13330 South Ridge Drive · Charlotte, NC 28273, USA

Tel. +1 (704) 504-0222 · Fax +1 (704) 504-0223

www.lutze.com · info@lutze.com

United Kingdom: LÜTZE Ltd.

Unit 3, Sandy Hill Park

Sandy Way, Amington · GB-Tamworth, Staffs B77 4DU

Tel. +44 (0)1827 31333-0 · Fax +44 (0)1827 31333-2

www.lutze.com · sales.gb@lutze.co.uk



SYSTEMATIC TECHNOLOGY

5: Characteristic slow-3

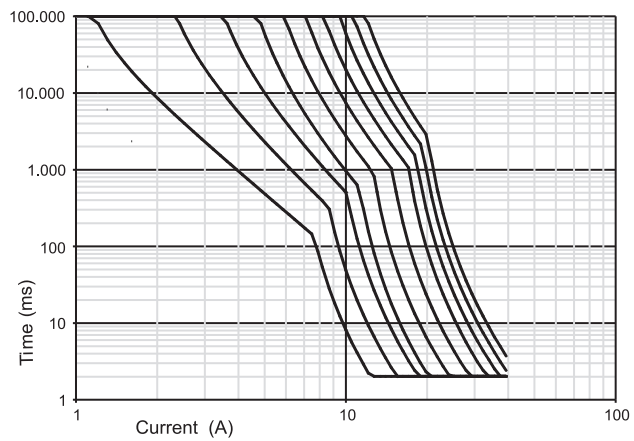

25.08.2017 – Subject to technical modification

Part-No. 716407.xxxx

USA: LUTZE INC.

13330 South Ridge Drive · Charlotte, NC 28273, USA

Tel. +1 (704) 504-0222 · Fax +1 (704) 504-0223

www.lutze.com · info@lutze.com

United Kingdom: LÜTZE Ltd.

Unit 3, Sandy Hill Park

Sandy Way, Amington · GB-Tamworth, Staffs B77 4DU

Tel. +44 (0)1827 31333-0 · Fax +44 (0)1827 31333-2

www.lutze.com · sales.gb@lutze.co.uk



SYSTEMATIC TECHNOLOGY

Technical data sheet · Load monitoring

Signal output

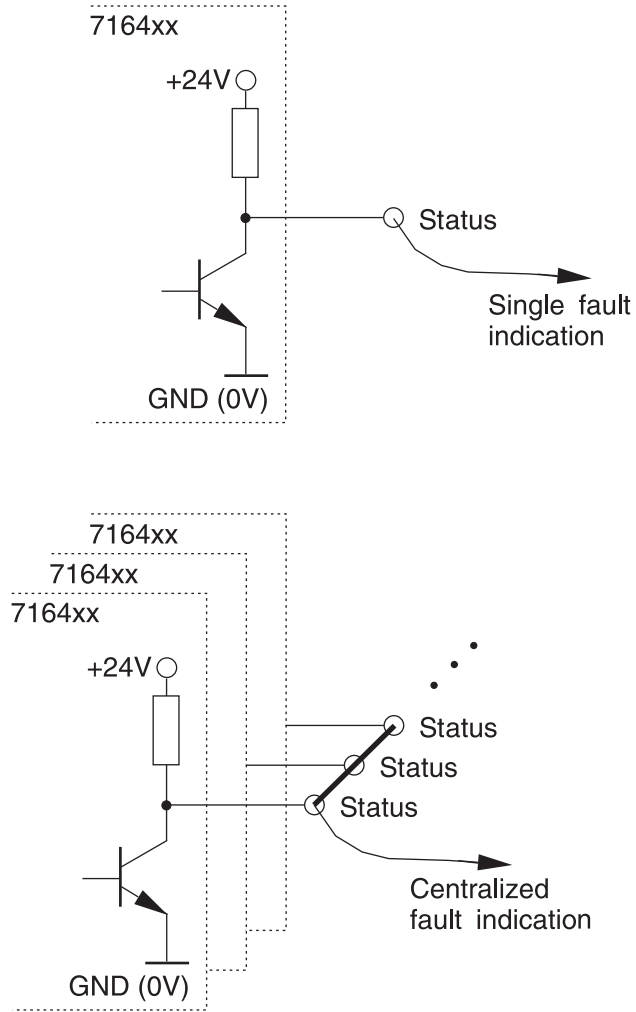

Order code

716407. 2 3 50	
Type	PU
	00 1 pc.
	50 50 pcs.
Current range	Characteristic
1 1A	1 fast
2 2A	2 medium
3 3A	3 slow-1
⋮	4 slow-2
0 10A	5 slow-3

25.08.2017 – Subject to technical modification

Part-No. 716407.xxxx

USA: LUTZE INC.

13330 South Ridge Drive · Charlotte, NC 28273, USA

Tel. +1 (704) 504-0222 · Fax +1 (704) 504-0223

www.lutze.com · info@lutze.com

United Kingdom: LÜTZE Ltd.

Unit 3, Sandy Hill Park

Sandy Way, Amington · GB-Tamworth, Staffs B77 4DU

Tel. +44 (0)1827 31333-0 · Fax +44 (0)1827 31333-2

www.lutze.com · sales.gb@lutze.co.uk



SYSTEMATIC TECHNOLOGY

Technical data sheet - Load monitoring

Type code

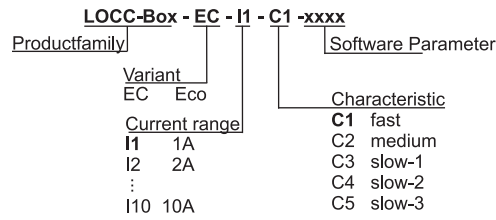

25.08.2017 – Subject to technical modification

Part-No. 716407.xxxx

USA: LUTZE INC.

13330 South Ridge Drive • Charlotte, NC 28273, USA

Tel. +1 (704) 504-0222 • Fax +1 (704) 504-0223

www.lutze.com • info@lutze.com

United Kingdom: LÜTZE Ltd.

Unit 3, Sandy Hill Park

Sandy Way, Amington • GB-Tamworth, Staffs B77 4DU

Tel. +44 (0)1827 31333-0 • Fax +44 (0)1827 31333-2

www.lutze.com • sales.gb@lutze.co.uk



SYSTEMATIC TECHNOLOGY