

Technical data sheet -

Jumper comb

Identification	Type	BK 7-2812 rt 4-polig
	Part-No.	762812

Description

red

Technical data

Rated current	DC 6 A
Pole number	4

General

Connection device	plug-in
Contact design	Flat contact 0.5 mm Ribbing on the sides
Pin spacing	6.2 mm
Length	24.8 mm
Contact material	CuZn
Material	Vectra C 1330
Color	red
Flamability according to UL 94	V0
Operation temperature range	-40 °C ... +80 °C
Storage temperature range	-40 °C ... +80 °C
Weight	0.0020 kg/piece
PU	10

25.08.2017 – Subject to technical modification

Part-No. 762812

USA: LUTZE INC.

13330 South Ridge Drive • Charlotte, NC 28273, USA
Tel. +1 (704) 504-0222 • Fax +1 (704) 504-0223
www.lutze.com • info@lutze.com

United Kingdom: LÜTZE Ltd.

Unit 3, Sandy Hill Park
Sandy Way, Amington • GB-Tamworth, Staffs B77 4DU
Tel. +44 (0)1827 31333-0 • Fax +44 (0)1827 31333-2
www.lutze.com • sales.gb@lutze.co.uk



SYSTEMATIC TECHNOLOGY

Technical data sheet

Dimensions

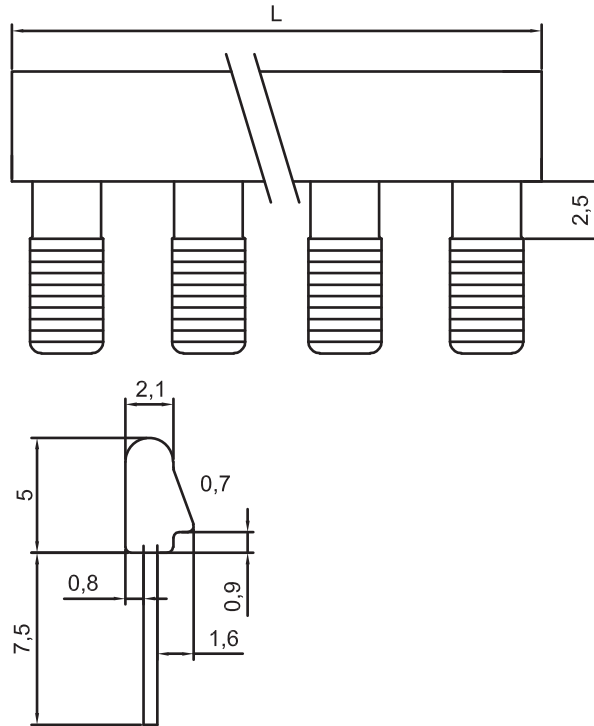

25.08.2017 – Subject to technical modification

Part-No. 762812

USA: LUTZE INC.

13330 South Ridge Drive • Charlotte, NC 28273, USA

Tel. +1 (704) 504-0222 • Fax +1 (704) 504-0223

www.lutze.com • info@lutze.com

United Kingdom: LÜTZE Ltd.

Unit 3, Sandy Hill Park

Sandy Way, Amington • GB-Tamworth, Staffs B77 4DU

Tel. +44 (0)1827 31333-0 • Fax +44 (0)1827 31333-2

www.lutze.com • sales.gb@lutze.co.uk



SYSTEMATIC TECHNOLOGY