



Identification	Type	LCOS-CC-2K-1P DC 24V
	Part-No.	779000.2111
Description	Electronic load monitoring up to DC 10 A 2-channel version, single pole switching, DC 1 A – DC 10 A, characteristic can be set Collective fault message: single/collective/90% message, Remote Control input	
Input	2-channel 1 pin switching	
Type of function	DC 24 V	
Rated voltage U_N	DC 20.4–28.8 V	
Operation voltage range	– 30 V	
Input voltage range	DC 10 A	
Rated current I_N	2	
Degree of pollution	DC 32 A via LCOS Powerbus	
Supply current	internal electronics	
Reverse voltage protection		
Control input (Set / Reset)	DC 24 V acc. to EN 61131	
Signal level	Pulse with falling edge >100 ms, <800 ms	
OFF	Pulse with falling edge > 1 s	
ON	X2: 12-pin multi-point plug, RM 3.5	
Connection type control side		

25.08.2017 – Subject to technical modification

Part-No. 779000.2111

USA: LUTZE INC.

13330 South Ridge Drive • Charlotte, NC 28273, USA
Tel. +1 (704) 504-0222 • Fax +1 (704) 504-0223
www.lutze.com • info@lutze.com

United Kingdom: LÜTZE Ltd.

Unit 3, Sandy Hill Park
Sandy Way, Amington • GB-Tamworth, Staffs B77 4DU
Tel. +44 (0)1827 31333-0 • Fax +44 (0)1827 31333-2
www.lutze.com • sales.gb@lutze.co.uk



SYSTEMATIC TECHNOLOGY

Technical data sheet • Load monitoring

Isolation voltage 1 kV, 50 Hz, 1 min.

Output

Switching element MosFet
Output current max. DC 10 A
Voltage drop <170 mV (10 A)
Status display output LED green: operating voltage ON, no fault, green flashing: 90 % I_B
LED red flashing: triggered, red: OFF
Switch-on capacity >10000 µF
Current range 1 A – 10 A (adjustable via switch in 1 A steps)
Characteristic fast (1), medium (2), slow 1 (3), slow 2 (4), slow 3 (5), adjustable via switch

Signal output

Switching element Transistor, open collector with pull-up resistor
Single channel message (Status CH1, CH2) Acc. to IEC 61131-2: High level, no errors, low level, there are errors
90 % of the rated current I_B (Status 90 % CH1, CH2) Acc. to IEC 61131-2: High level <90 %, low level >90 %
centralised fault signalling (Status Out) Single channel message 1+2, decoupled via diodes

General

Operation temperature range 0 °C ... +55 °C
Storage temperature range -40 °C ... +70 °C
Dimensions (w × h × d) 22.5 × 110.0 × 102.0 mm
(including function carrier, without plug-in terminals on the side)
Housing material PA 6.6 (UL 94 V-0, NFF I2, F2)
Mounting plug-in
on LCOS function carrier
22.5 mm (Accessories)
DIN rail mounting
(EN 60715)
Protection class IP20
Installation position any
Vibration resistance Vibration: EN 60068-2-6 Fc, shock: EN 60068-2-27 Ea
Climatic conditions Acc. to EN 60721 Stationary use at weather protected locations
Over voltage category II
Degree of pollution 2
Connection type load side X1: 8-pin multi-point plug, RM 5.08
Connection type control side X2: 12-pin multi-point plug, RM 3.5
Connection device single wire
0.08 mm²–1.5 mm² / AWG 28–16
Strip length RM 3.5: 9 mm, RM 5.08: 10 mm
Weight 0.200 kg/piece

25.08.2017 – Subject to technical modification

Part-No. 779000.2111

USA: LUTZE INC.

13330 South Ridge Drive • Charlotte, NC 28273, USA

Tel. +1 (704) 504-0222 • Fax +1 (704) 504-0223

www.lutze.com • info@lutze.com

United Kingdom: LÜTZE Ltd.

Unit 3, Sandy Hill Park

Sandy Way, Amington • GB-Tamworth, Staffs B77 4DU

Tel. +44 (0)1827 31333-0 • Fax +44 (0)1827 31333-2

www.lutze.com • sales.gb@lutze.co.uk



SYSTEMATIC TECHNOLOGY

Technical data sheet · Load monitoring

Approvals	cULus (E170585) CE UL 61010 UL 2367 GL in preparation
Standards	EN 61131-2 EN 55016-1-2 EN 60529 EN 61000-6-2/4
PU	1 piece

Note

Included in the delivery	Plug-in terminals : CS 5.08 and CS 3.50
Not included in the delivery	Function carrier and other accessories

Dimensions

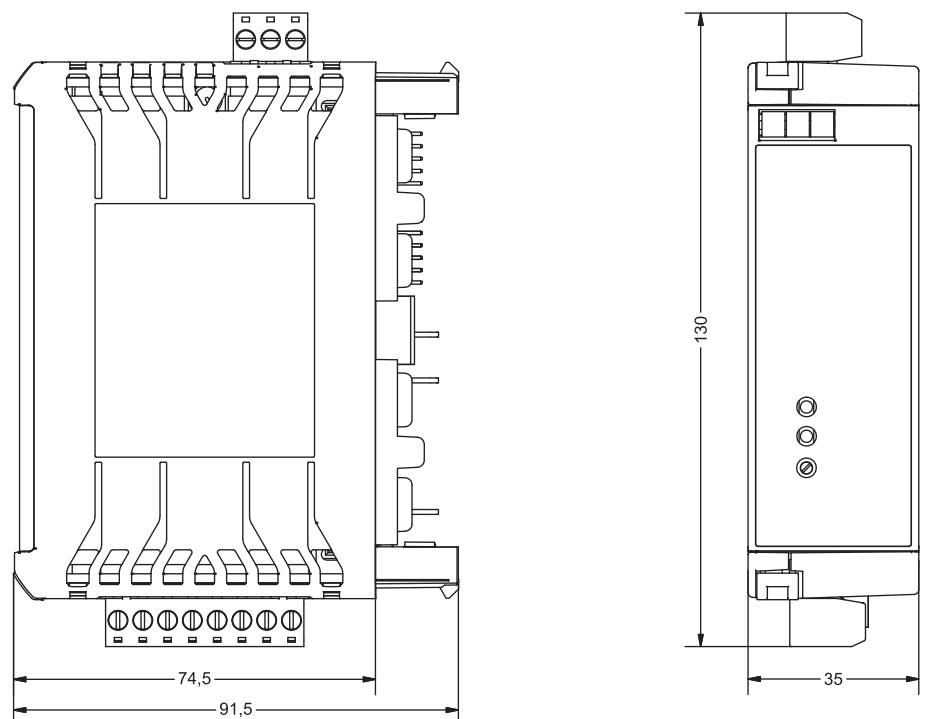

25.08.2017 – Subject to technical modification

Part-No. 779000.2111

USA: LUTZE INC.

13330 South Ridge Drive · Charlotte, NC 28273, USA
Tel. +1 (704) 504-0222 · Fax +1 (704) 504-0223
www.lutze.com · info@lutze.com

United Kingdom: LÜTZE Ltd.

Unit 3, Sandy Hill Park
Sandy Way, Amington · GB-Tamworth, Staffs B77 4DU
Tel. +44 (0)1827 31333-0 · Fax +44 (0)1827 31333-2
www.lutze.com · sales.gb@lutze.co.uk

Technical data sheet · Load monitoring

PIN assignment

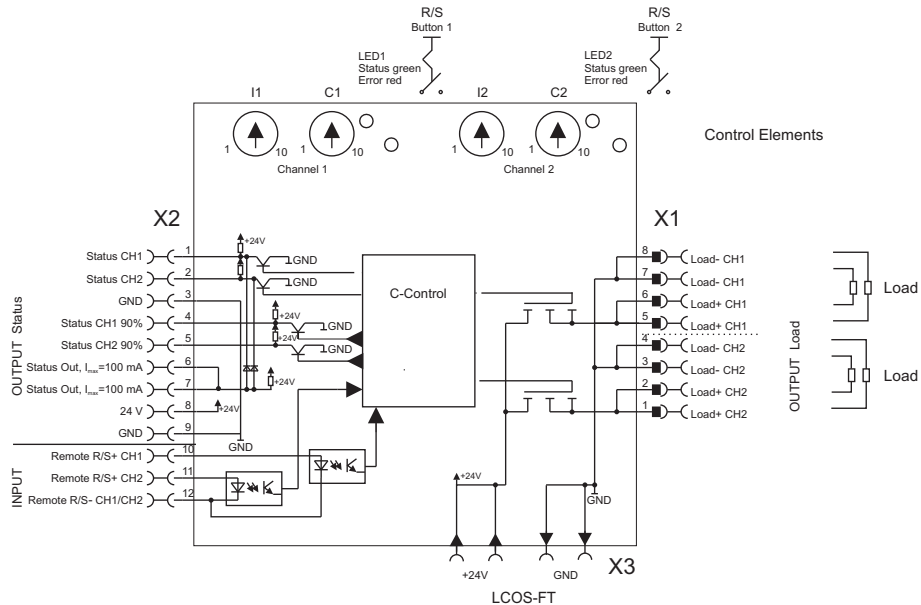

PIN assignment

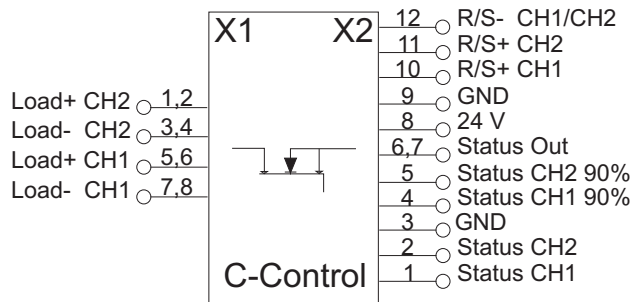

25.08.2017 – Subject to technical modification

Part-No. 779000.2111

USA: LUTZE INC.

13330 South Ridge Drive · Charlotte, NC 28273, USA

Tel. +1 (704) 504-0222 · Fax +1 (704) 504-0223

www.lutze.com · info@lutze.com

United Kingdom: LÜTZE Ltd.

Unit 3, Sandy Hill Park

Sandy Way, Amington · GB-Tamworth, Staffs B77 4DU

Tel. +44 (0)1827 31333-0 · Fax +44 (0)1827 31333-2

www.lutze.com · sales.gb@lutze.co.uk



SYSTEMATIC TECHNOLOGY

Technical data sheet · Load monitoring

1: Characteristic fast

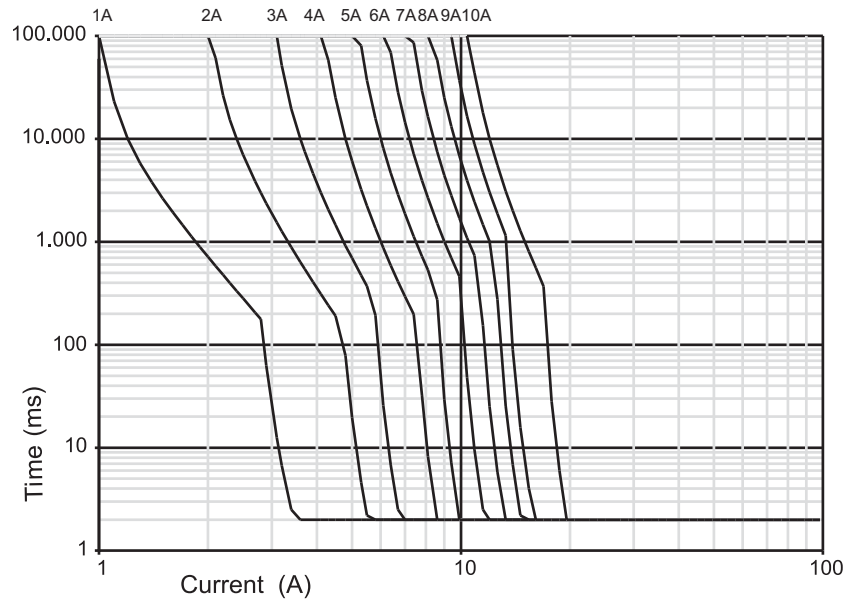

2: Characteristic medium

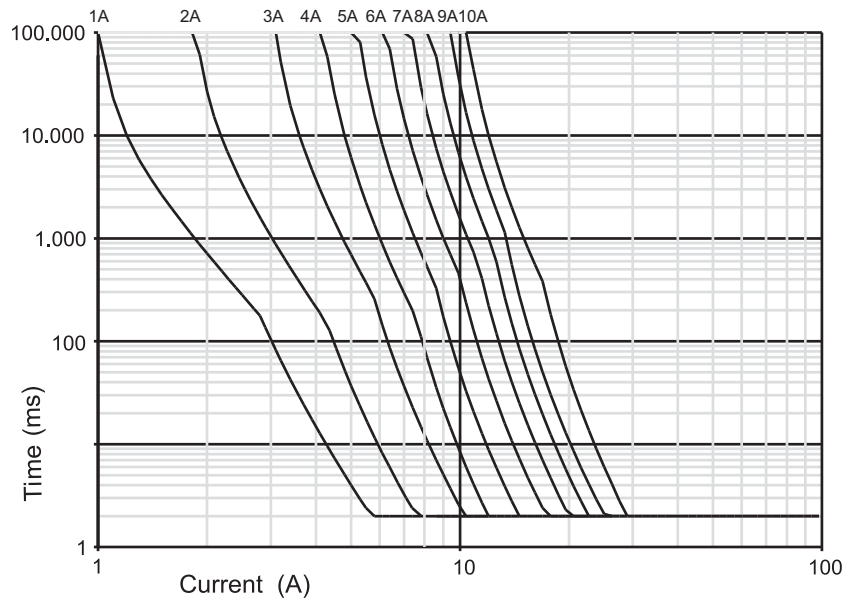

25.08.2017 – Subject to technical modification

Part-No. 779000.2111

USA: LUTZE INC.

13330 South Ridge Drive · Charlotte, NC 28273, USA

Tel. +1 (704) 504-0222 · Fax +1 (704) 504-0223

www.lutze.com · info@lutze.com

United Kingdom: LÜTZE Ltd.

Unit 3, Sandy Hill Park

Sandy Way, Amington · GB-Tamworth, Staffs B77 4DU

Tel. +44 (0)1827 31333-0 · Fax +44 (0)1827 31333-2

www.lutze.com · sales.gb@lutze.co.uk



SYSTEMATIC TECHNOLOGY

3: Characteristic slow-1

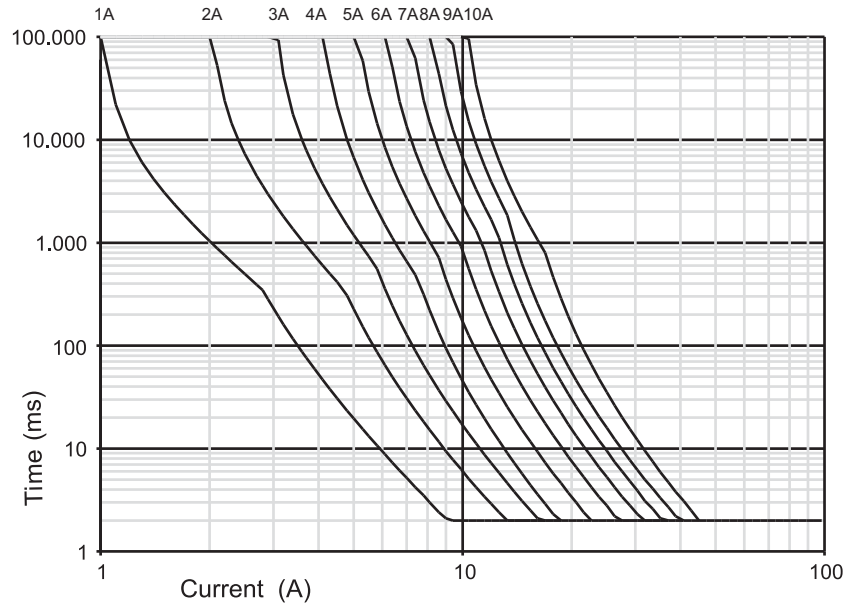

4: Characteristic slow-2

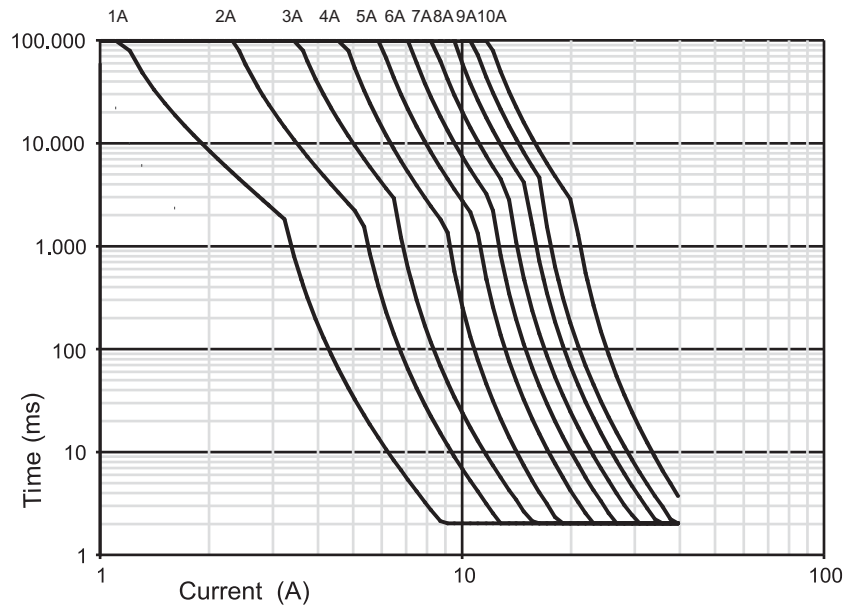

25.08.2017 – Subject to technical modification

Part-No. 779000.2111

USA: LUTZE INC.

13330 South Ridge Drive · Charlotte, NC 28273, USA

Tel. +1 (704) 504-0222 · Fax +1 (704) 504-0223

www.lutze.com · info@lutze.com

United Kingdom: LÜTZE Ltd.

Unit 3, Sandy Hill Park

Sandy Way, Amington · GB-Tamworth, Staffs B77 4DU

Tel. +44 (0)1827 31333-0 · Fax +44 (0)1827 31333-2

www.lutze.com · sales.gb@lutze.co.uk

5: Characteristic slow-3

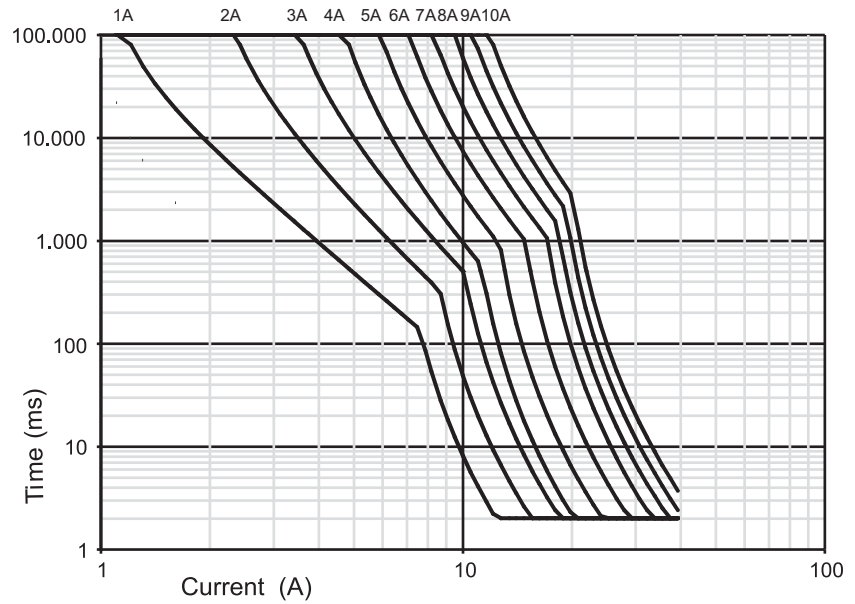

25.08.2017 – Subject to technical modification

Part-No. 779000.2111

USA: LUTZE INC.

13330 South Ridge Drive · Charlotte, NC 28273, USA

Tel. +1 (704) 504-0222 · Fax +1 (704) 504-0223

www.lutze.com · info@lutze.com

United Kingdom: LÜTZE Ltd.

Unit 3, Sandy Hill Park

Sandy Way, Amington · GB-Tamworth, Staffs B77 4DU

Tel. +44 (0)1827 31333-0 · Fax +44 (0)1827 31333-2

www.lutze.com · sales.gb@lutze.co.uk



SYSTEMATIC TECHNOLOGY